

# AGRAS T16

## User Manual

v1.4

2020.05

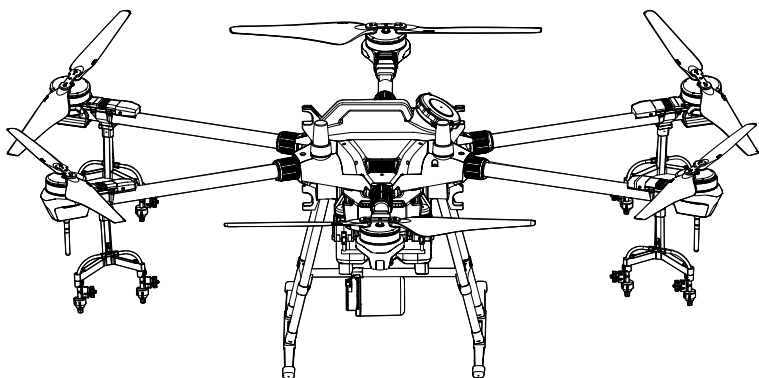

### **Searching for Keywords**

Search for keywords such as “battery” and “install” to find a topic. If you are using Adobe Acrobat Reader to read this document, press Ctrl+F on Windows or Command+F on Mac to begin a search.

### **Navigating to a Topic**

View a complete list of topics in the table of contents. Click on a topic to navigate to that section.

### **Printing this Document**

This document supports high resolution printing.

## Information

1. The AGRAS™ T16 does not come with a flight battery. Only purchase official DJI™ flight batteries (model: AB2-17500mAh-51.8V). Read the T16 Intelligent Flight Battery User Guide and take necessary precautions when handling the batteries to ensure your own safety. DJI™ assumes no liability for damage or injury incurred directly or indirectly from misusing batteries.
2. In this document, the altitude limit of 30 m means the altitude between the aircraft and the surface of the objects below it when the altitude stabilization function of the radar module is enabled. If the function is disabled, the altitude limit means the altitude between the aircraft and the takeoff point.

## Using This Manual

### Legend

 Important

 Hints and tips

 Reference

### Before Flight

The following documents have been produced to help you safely operate and make full use of your aircraft:

1. In the Box
2. Disclaimer and Safety Guidelines
3. Quick Start Guide
4. User Manual

Refer to the Agras T16 In the Box to check the listed parts and read the disclaimer and safety guidelines before flight. Refer to the quick start guide for more information on assembly and basic operation. Refer to the user manual for more comprehensive information.

### Downloading DJI Assistant 2 for MG

Download DJI ASSISTANT™ 2 for MG from:  
<https://www.dji.com/t16/info#downloads>

---

 The operating temperature of this product is 0° to 40° C. It does not meet the standard operating temperature for military grade application (-55° to 125° C), which is required to endure greater environmental variability. Operate the product appropriately and only for applications that it meets the operating temperature range requirements of that grade.

---

# Safety at a Glance

## 1. Pesticide Usage

- Avoid the use of **powder pesticides** as much as possible as they may reduce the service life of the spraying system.
- Pesticides are **poisonous and pose serious risks to safety**. Only use them in strict accordance with their specifications.
- Residue on the equipment caused by splashes or spills **when pouring and mixing the pesticide can irritate your skin**. Make sure to clean the equipment after mixing.
- Use **clean water** to mix the pesticide and filter the mixed liquid before pouring into the spray tank to avoid blocking the strainer. **Clear any blockage** before using the equipment.
- Make sure to **stay in an upwind area** when spraying pesticide to avoid bodily harm.
- **Wear protective clothing** to prevent direct body contact with the pesticide. **Rinse your hands and skin** after handling pesticides. **Clean the aircraft and remote controller** after applying the pesticide.
- Effective use of pesticides depends on **pesticide density, spray rate, spray distance, aircraft speed, wind speed, wind direction, temperature, and humidity**. Consider all factors when using pesticides, but **DO NOT** compromise the safety of people, animals, or the environment in doing so.
- **DO NOT contaminate** rivers and sources of drinking water.



The AGRAS™ T16 aircraft is not a toy and is not suitable for children under the age of 18.

Note that the Safety at a Glance section only provides a quick overview of the safety tips. Make sure you read and understand this document and the user manual.

## 2. Environmental Considerations

- Always fly at locations that are clear of **buildings and other obstacles**. **DO NOT** fly above or near large crowds.
- The recommended maximum operating altitude is **2 km (6,560 ft) above sea level**. **DO NOT** fly over 3 km (9,842 ft) above sea level.
- Only fly in moderate weather conditions with temperatures between **0° to 40° C (32° to 104° F)**.
- Make sure that your operations do not violate any applicable laws or regulations, and that you have obtained all appropriate prior authorizations. Consult the relevant government agency or authority, or your lawyer before flight to ensure you comply with all relevant laws and regulations.
- **DO NOT operate any part of the aircraft indoors**.

## 3. Pre-Flight Checklist

Make sure to check all of the following:

- Remote controller and aircraft batteries are **fully charged**.
- All parts are in **good condition**. Replace aged or broken parts before flight.
- **Landing gear and spray tank** are firmly in place.
- Propellers and frame arms are unfolded and arm sleeves are firmly tightened. **Propellers are in good condition and firmly tightened**. There is nothing obstructing the motors and propellers.
- **Spraying system is not blocked** and works properly.
- **Compass is calibrated** after being prompted to do so in the app.

## 4. Ingress Protection Rating Description

The T16 is waterproof, dustproof, and corrosion-resistant when it is functioning normally. Under stable laboratory conditions, the aircraft has a protection rating of IP54 (IEC standard 60529). The aerial-electronics system (barometer excluded), spray control system, ESC system, and radar module has a protection rating of up to IP67. However, this protection rating is not permanent and may reduce

over time after long-term use due to aging and wear. The product warranty does not cover water damage.

The protection ratings of the aircraft mentioned above may decrease in the following scenarios:

- There is a collision and the seal structure is deformed.
- The seal structure of the shell is cracked or damaged.
- The waterproof covers are not properly secured.

## 5. Operation

- **Stay away from the rotating propellers and motors.**
- The takeoff weight must not exceed 42 kg when using near sea level. Note that when using at a higher sea level, the takeoff weight capacity will be reduced.
- Once the operating altitude reaches 1 km (3,280 ft), the payload capacity of the spray tank is reduced by 2 kg. For every additional km, the payload capacity will be reduced another 2 kg.
- Maintain a visual line of sight (VLOS) of your aircraft at all times.
- DO NOT use the Combination Stick Command (CSC) or other methods to stop the motors when the aircraft is airborne unless in an emergency situation.
- DO NOT answer incoming calls during flight. DO NOT fly under the influence of alcohol or drugs.
- **If there is a low battery warning, land the aircraft at a safe location.**
- If the radar module is unable to work properly in the operating environment, the aircraft will be unable to avoid obstacles during RTH. All that can be adjusted is the flight speed and altitude, as long as the remote controller is still connected.
- After landing, stop the motors, power off the aircraft, and turn off the remote controller. Otherwise, the aircraft may enter Failsafe RTH automatically due to remote controller signal loss.
- Maintain full control of the aircraft at all times and do not rely on the DJI MG2 app. The obstacle avoidance function is disabled in certain situations. Keep the aircraft within VLOS and pay close attention to its flight. Use your discretion to operate the aircraft and manually avoid obstacles in a timely manner. It is important to set an appropriate Failsafe and RTH altitude before each flight.

## 6. Maintenance and Upkeep

- DO NOT use aged, chipped, or broken propellers.
- To avoid damaging the landing gear, remove or empty the spray tank during transportation or when not in use.
- Recommended storage temperature (**when the spray tank, flow meter, pumps, and hoses are empty**): between -20° and 40° C (-4° and 104° F).
- Clean the aircraft immediately after spraying. Inspect the aircraft regularly. Refer to the Product Care section in the disclaimer and safety guidelines for more information about maintenance guidelines.

## 7. Observe Local Laws and Regulations

- You can find a list of DJI GEO zones at <http://www.dji.com/flysafe>. Note that the DJI GEO zones are not a replacement for local government regulations or good judgment.
- **Avoid flying at altitudes above 30 m (98 ft).\***

\* In this document, the altitude limit of 30 m means the altitude between the aircraft and the surface of the objects below it when the altitude stabilization function of the radar module is enabled. If the function is disabled, the altitude limit means the altitude between the aircraft and the takeoff point.

The flying altitude limit varies in different countries or regions. Make sure to fly at the altitudes outlined by local laws and regulations.



Fly in Open Areas

+

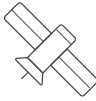

Strong GNSS Signal

+



VLOS

+



Fly Below 30 m (98 ft)

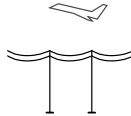

Avoid flying over or near crowds, high voltage power lines, or bodies of water. Strong electromagnetic sources such as power lines, base stations, and tall buildings may affect the onboard compass.



DO NOT use the aircraft in adverse weather conditions such as winds exceeding 28 kph (17 mph), heavy rain (precipitation rate exceeding 25 mm (0.98 in) in 12 hours), fog, snow, lightning, tornadoes, or hurricanes.

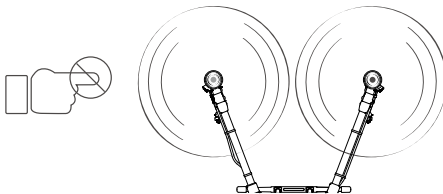

Stay away from the rotating propellers and motors.



GEO Zones

Learn more at: <http://www.dji.com/flysafe>

# Contents

<b>Information</b>	1
<b>Using This Manual</b>	1
Legend	1
Before Flight	1
Downloading DJI Assistant 2 for MG	1
<b>Safety at a Glance</b>	2
<b>Product Profile</b>	7
Introduction	7
Feature Highlights	7
Preparing the Aircraft	8
Preparing the Remote Controller	9
Aircraft Overview	11
Remote Controller Overview	12
<b>Aircraft</b>	14
Aircraft Profile	14
Flight Modes	14
Operation Modes	14
Operation Resumption	20
System Data Protection	22
DBF Imaging Radar	23
Empty Tank	25
Return to Home (RTH)	25
Low Battery and Low Voltage Warnings	27
RTK Functions	28
<b>Remote Controller</b>	29
Profile	29
Using the Remote Controller	29
Remote Controller LEDs	34
Linking the Remote Controller	34
Multi-Aircraft Control Function	35

<b>DJI MG2 App</b>	37
Home Screen	37
Operation View	38
<b>Flight</b>	42
Operation Environment	42
Flight Limits and GEO Zones	42
Pre-Flight Checklist	44
Calibrating the Spraying System	44
Calibrating the Compass	45
Starting and Stopping the Motors	47
Flight Test	48
<b>DJI Assistant 2 for MG</b>	49
Installation and Launching	49
Using DJI Assistant 2 for MG	49
<b>Appendix</b>	50
Specifications	50
Aircraft Status Indicators Description	53
Updating the Firmware	53



# Product Profile

## Introduction

The Agras T16 features a brand-new design including a foldable frame, quick-release spray tank, and flight battery, making replacement, installation, and storage easy. The stable and reliable modular aerial-electronics system is integrated with a dedicated industrial flight controller, OCUSYNC™ 2.0 HD transmission system, and RTK module. It has dual IMUs and barometers and adopts a propulsion control system redundancy design including both digital and analog signals to ensure flight safety. The GNSS+RTK dual-redundancy system is compatible with GPS, GLONASS, BeiDou, and Galileo. The T16 also supports centimeter-level positioning \* when used with the onboard D-RTK™ antennas. Dual-antenna technology provides strong resistance against magnetic interference. The upgraded spraying system features an improvement in payload, spray rate, and spray width. It also has a new-generation electromagnetic flow meter, providing high precision and stability. The all-new digital beam forming (DBF) imaging radar features obstacle sensing and terrain following capabilities during both day and night, without being affected by light or dust. It can also plan a flight path to actively circumvent obstacles. The aircraft is equipped with a wide-angle FPV camera enabling observation of the landscape from the front of the aircraft.

The quality of the industrial design and materials of the aircraft make it dustproof, waterproof, and corrosion-resistant. The aircraft has a protection rating of IP54 (IEC standard 60529), while the protection rating of the aerial-electronics system, spray control system, and propulsion ESC system is up to IP67.

The remote controller uses the DJI OcuSync 2.0 dual-band transmission system, which has a maximum control distance of up to 5 km (3.11 mi) \*, and is equipped with a bright, dedicated screen with DJI MG2 built in. Plan operations using the remote controller, an RTK handheld mapping device, or by flying the aircraft to waypoints. Along with the upgraded spraying system, flight operation is more flexible and efficient. The Multi-Aircraft Control mode of the remote controller can be used to coordinate the operation of up to five aircraft at the same time, enabling pilots to work efficiently. Replaceable batteries allow users to operate the remote controller for longer, and removable antennas make maintenance easier.

## Feature Highlights

The all-new modular design of the T16 simplifies assembly. The airframe can be quickly folded, making it easy for transportation. Both the battery and spray tank are easily swappable, significantly improving the efficiency of power and liquid supply.

The T16 has an aerial-electronics system with a multiple redundancy design, and also has onboard D-RTK antennas, supporting dual-antenna technology that provides strong resistance against magnetic interference to ensure flight safety.

Thanks to the dedicated DJI industrial flight control system, the T16 offers four operation modes: Route, A-B Route, Manual, and Manual Plus.

DJI MG2 automatically produces flight routes based on your planned fields. To start, simply select the field from the field list. Plan a field by walking with the remote controller, an RTK handheld mapping device, or by flying the aircraft to waypoints, according to the application scenarios. In scenarios with complicated terrain, use the PHANTOM™ 4 RTK and DJI Terra to plan 3D flight routes, and import the routes to DJI MG2 for operation.

\* This must be used with a DJI D-RTK 2 High Precision GNSS Mobile Station (sold separately) or a DJI-approved Network RTK service.

The remote controller is able to reach its maximum transmission distance (FCC/NCC: 5 km (3.11 mi); CE/KCC/MIC/SRRC: 3 km (1.86 mi)) in an open area with no electromagnetic interference, and at an altitude of approximately 2.5 m (8.2 ft).

In A-B Route operation mode, the aircraft travels along a planned route and sprays its liquid payload. Users can set the line spacing, flying speed, and other parameters.

In Manual operation mode, users can start and stop spraying manually and also adjust the spray rate.

In Manual Plus operation mode, the flight speed is restricted and the heading is locked. Except for the heading, users can control the movement of the aircraft via the control sticks. Press button C1 or C2 on the remote controller or the corresponding button in the app and the aircraft will fly one line spacing to the left or right. Note that this is the default function for button C1 and button C2. They are customizable in the app.

The T16 also includes the Operation Resumption function. When pausing the operation in Route or A-B Route operation mode, Operation Resumption records a breakpoint for the aircraft. Users can resume from the breakpoint when continuing the operation.

The remote controller features Multi-Aircraft Control mode, which can be used to coordinate the operation of up to five aircraft simultaneously. Turn the aircraft control switch dial on the remote controller to switch control between different aircraft.

The DBF imaging radar works automatically in Route, A-B Route, and Manual Plus operation modes during both day and night, without being affected by light or dust. Altitude detection and stabilization functions are available in forward, backward, and downward directions while Obstacle Avoidance is available in forward or backward direction according to the direction of flight. The radar module can detect the angle of a slope and automatically adjust to maintain the same distance with the surface even in mountainous terrain. In Route and A-B Route operation modes, the radar can effectively sense obstacles and plan a flight route to actively circumvent obstacles. Note that this is disabled by default. Users can enable it in the app.

The upgraded spraying system includes eight sprinklers placed on both sides of the aircraft to provide evenly distributed spraying and coverage of the liquid payload, and an all-new electromagnetic flow meter for higher precision and stability than conventional flow meters.

## Preparing the Aircraft

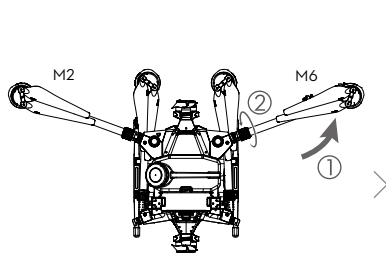

Unfold the M2 and M6 arms, and tighten the two arm sleeves.

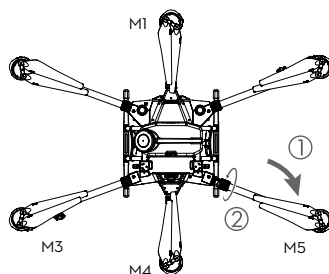

Unfold the M3 and M5 arms followed by M1 and M4, and then tighten the four arm sleeves.

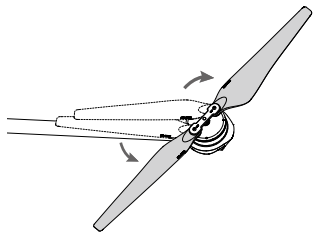

Unfold the propeller blades.

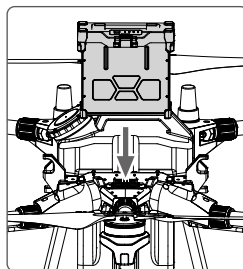

Insert the Intelligent Flight Battery into the aircraft until you hear a click.

- ⚠ • Make sure that the battery is firmly inserted into the aircraft. Only insert or remove the battery when the aircraft is powered off.
- To remove the battery, press and hold the clamp, and then lift the battery up.
- When folding the arms, make sure to fold the M3 and M5 arms first, and then the M2 and M6 arms. Otherwise, the arms may be damaged. Lift and lower the M1 and M4 arms gently to reduce wear and tear.

## Preparing the Remote Controller

### Mounting the Battery

The remote controller uses an easily removable, interchangeable Intelligent Battery for long-term operation.

- ① Slide the battery compartment cover lock on the back of the remote controller down to open the cover.
- ② Insert the Intelligent Battery into the compartment and push it to the top.
- ③ Close the cover.

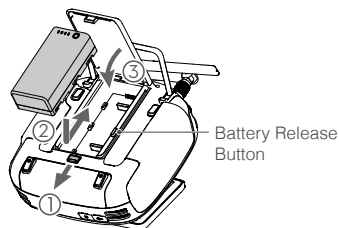

- ☀ To remove the Intelligent Battery, open the cover, press and hold the battery release button, then push the battery downward.

### Mounting the Dongle and SIM Card

- ⚠ • Only use a DJI-approved dongle. The dongle supports various network standards. Use a SIM card that is compatible with the chosen mobile network provider, and select a mobile data plan according to the planned level of usage.
- The dongle and SIM card enable the remote controller to access specific networks and platforms, such as the DJI AG platform. Make sure to employ them correctly. Otherwise, network access will not be available.

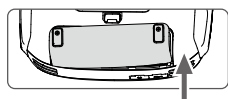

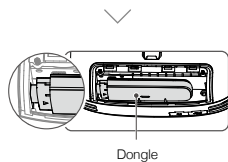

Lift the dongle compartment cover at the gap at its lower right corner, then remove it.

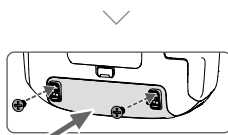

Insert the dongle into the USB port with the SIM card inserted into the dongle, and test it. \*



Reattach the cover. To secure the cover, open the silicone protectors, insert and tighten two Phillips screws, and close the protectors.

\* Test procedure: Press the remote controller power button once, then press again and hold to power the remote controller on. In DJI MG2, tap , then , and select Network Diagnostics. The dongle and SIM card are functioning properly if the status of all the devices in the network chain are shown in green.

## Unfolding the Remote Controller

Tilt the display device on the remote controller to the desired position, then adjust the antennas.

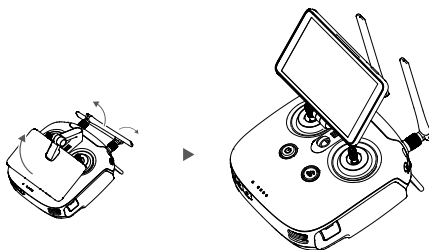

## Aircraft Overview

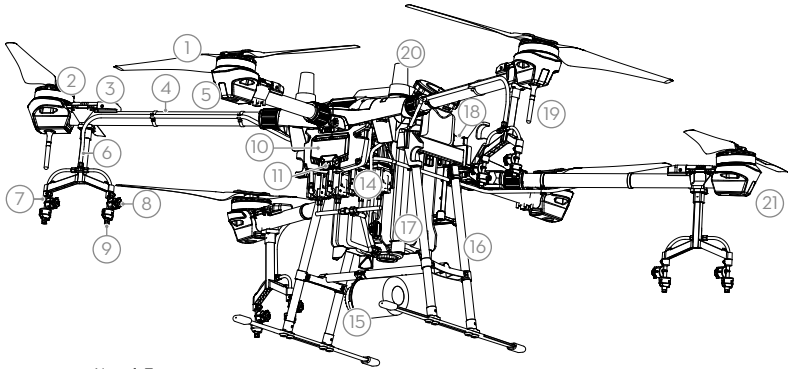

● Aircraft Front

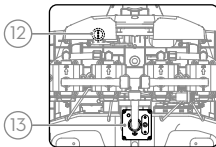

Bottom View

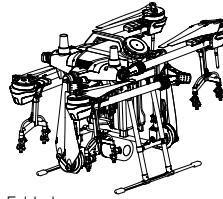

Folded

- |   |   |
|---|---|
| <ol style="list-style-type: none"> <li>1. Propellers</li> <li>2. Motors</li> <li>3. ESCs</li> <li>4. Frame Arms</li> <li>5. Aircraft Front LEDs<br/>(on the three front arms)</li> <li>6. Hoses</li> <li>7. Sprinklers</li> <li>8. Manual Relief Valve</li> <li>9. Nozzles</li> <li>10. Aerial-Electronics System</li> <li>11. FPV Camera</li> <li>12. USB-C Port<br/>(on the bottom of the aerial-electronics system, under the waterproof cover)</li> </ol> | <ol style="list-style-type: none"> <li>13. Flow Meter</li> <li>14. Delivery Pumps</li> <li>15. DBF Imaging Radar</li> <li>16. Landing Gear</li> <li>17. Spray Tank</li> <li>18. Battery Compartment</li> <li>19. OcuSync Antennas</li> <li>20. Onboard D-RTK Antennas</li> <li>21. Aircraft Status Indicators<br/>(on the three rear arms)</li> </ol> |
|---|---|

## Remote Controller Overview

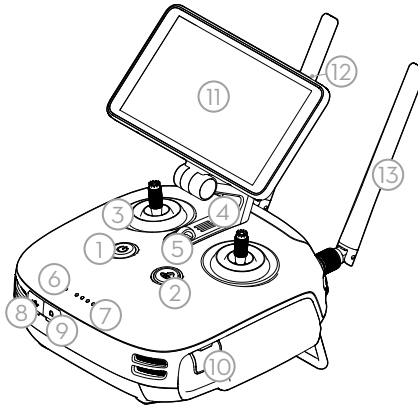

**1. Power Button**

Used to turn the remote controller on and off.

**2. RTH Button**

Press and hold this button to initiate RTH.

**3. Control Sticks**

Controls aircraft movement. Can be set to Mode 1, Mode 2, or Mode 3.

**4. Speaker**

Audio output.

**5. Lanyard Attachment**

Used to attach the remote controller lanyard.

**6. Status LED**

Indicates whether the remote controller is linked to the aircraft.

**7. Battery Level LEDs**

Displays current battery level.

**8. USB-C Port**

Connects to a computer via a USB-C cable for configuration. Connects to the aircraft via a USB-C OTG cable and a Micro USB cable for aircraft firmware update.

**9. 3.5 mm Audio Jack**

Used to connect an audio input or output device.

**10. microSD Card Slot**

Provides display device with up to 128 GB of extra storage.

**11. Display Device**

Android-based device to run DJI MG2.

**12. Sleep/Wake Button**

Press to sleep or wake the screen. Press and hold to restart.

**13. Antennas**

Relays aircraft control and image transmission signals.

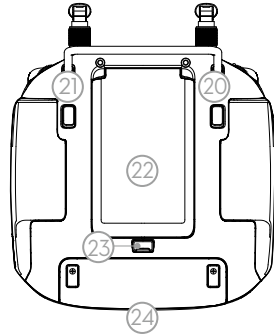
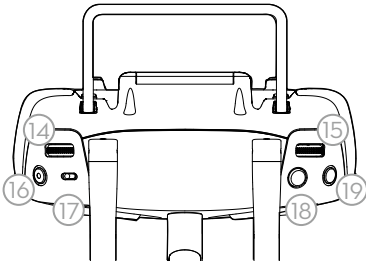

**14. Spray Rate Dial**

Turn to adjust the spray rate in Manual operation modes.

**15. Aircraft Control Switch Dial**

Turn and press the dial to switch among the aircraft when using Multi-Aircraft Control function.

**16. Spray Button**

Press to start or stop spraying in Manual operation mode.

**17. Pause Switch**

Toggle to pause the operation in Route, A-B Route, or Manual Plus operation modes.

During RTH, toggle to pause RTH. The aircraft hovers, and then the aircraft can be controlled manually.

**18. Button A**

Records Point A of the operation route in A-B Route operations by default. Use the app to customize the button.

**19. Button B**

Records Point B of the operation route in A-B Route operations by default. Use the app to customize the button.

**20. Button C1**

When planning a field, press the button to start or end obstacle measurement. The function of the button cannot be customized while planning a field.

When not planning a field, use the app to customize the button.

**21. Button C2**

When planning a field, press the button to add a waypoint. The function of the button cannot be customized when planning a field.

When not planning a field, use the app to customize the button.

**22. Battery Compartment Cover**

Open the cover to mount or remove the Intelligent Battery from the remote controller.

**23. Battery Compartment Cover Lock**

Slide the lock down to open the cover.

**24. Dongle Compartment Cover**

Open the cover to mount or remove the dongle.

# Aircraft

## Aircraft Profile

The T16 uses a dedicated DJI industrial flight controller to provide multiple operation modes for various applications. The DBF imaging radar provides terrain following to guide the aircraft to maintain a constant distance above crops in specific operation modes and is capable to actively circumvent obstacles through Auto Bypass. Functions such as operation resumption, system data protection, empty tank warning, low battery level warning, and RTH are also available.



- When using your T16 for the first time, activate it in DJI MG2. A DJI account and internet connection are required.
- Effective use of pesticides depends on pesticide density, spray rate, spray distance, aircraft speed, wind speed, and wind direction. Consider all factors when using pesticides.
- Always fly at an appropriate height above crops to avoid damage.

## Flight Modes

**P-mode (Positioning):** The aircraft utilizes GNSS or the RTK module for positioning. When the GNSS signal is strong, the aircraft uses GNSS for positioning. When the RTK module is enabled and the differential data transmission is strong, it provides centimeter-level positioning. The aircraft reverts to A-mode when the GNSS signal is weak.

The aircraft will fly in P-mode by default.

**A-mode (Attitude):** GNSS is not used for positioning and the aircraft can only maintain altitude using the barometer. The aircraft enters A-mode only when there is weak GNSS signal or when the compass experiences interference. The flight speed in A-mode depends on its surroundings such as the wind speed.

In A-mode, the aircraft cannot position itself and is easily affected by its surroundings, which may result in horizontal shifting. Use the remote controller to position the aircraft.

Maneuvering the aircraft in A-mode can be difficult. Avoid flying in confined spaces or in areas where the GNSS signal is weak. Otherwise, the aircraft will enter A-mode, leading to potential flight risks. Land the aircraft in a safe place as soon as possible.

## Operation Modes

The T16 provides Route, A-B Route, Manual, and Manual Plus operation modes. Users can use DJI MG2 to switch between A-B Route, Manual, and Manual Plus.

### Route Operation Mode

After the operation area and obstacles have been measured and settings have been configured, DJI MG2 uses a built-in intelligent operation planning system to produce a flight route based on the user's input. Users can invoke an operation after planning a field. The aircraft will begin the operation automatically and follow the planned flight route. Operation resumption, altitude stabilization, obstacle avoidance, and auto bypass of the radar module are available in Route operation mode. Use the app to adjust work efficiency, which affects the flying speed and spray rates. Route operation mode is recommended for large spray areas.



## Field Planning

DJI MG2 supports multiple planning methods for various applications.

### Fly the Aircraft

Users can fly the aircraft to desired positions and use the app or the remote controller to add waypoints for outlining areas and measuring obstacles.

1. Power on the remote controller, enter DJI MG2, and then power on the aircraft.
2. Tap Field Plan and select Fly the Aircraft.
3. Make sure that the system status bar on top of the screen displays Manual Route for GNSS, or Manual Route for RTK if D-RTK is enabled.
4. Tap Start Measuring in the lower right corner of the screen. Fly the aircraft alongside the boundary of the target field. Tap Add Waypoint or go to each corner of the field and press the C2 button on the remote controller.
5. Mark any obstacles:

Use one of the two methods below to mark any obstacles in a target field.

- ① Tap Start Obstacle Measurement onscreen or press the C1 button on the back of the remote controller. Next, fly the aircraft around the obstacle, and tap End Obstacle Measurement onscreen or press the C1 button again.
  - ② Tap Start Obstacle Measurement onscreen or press the C1 button on the back of the remote controller. Next, fly the aircraft around the obstacle, and tap Add Waypoint onscreen or press the C2 button to add a waypoint. Tap End Obstacle Measurement onscreen or press the C1 button when finished.
6. Continue measuring the field by flying the aircraft alongside the boundary and adding waypoints at each corner of the field. Tap End Measurement when the field has been measured and all obstacles have been marked. DJI MG2 produces a flight route according to the field's perimeter and obstacles.
  7. Add calibration point: Fly the aircraft to the location of each calibration point. Tap Add Calibration Point onscreen.

The calibration points are used to offset the bias of the flight route caused by the positioning difference between the remote controller and aircraft. Choose at least one existing landmark as the fixed reference point for calibration when executing the same operation. If none are available, use an easily identifiable object such as a metal stake.

### Walk with RC

Users should walk along the boundary of the field or the obstacles with the remote controller for measurements. Make sure that the aircraft is powered off when planning your flight route.



1. Power on the remote controller and enter DJI MG2. Tap Field Plan and select Walk with RC.
2. Wait until the GNSS signal is strong. The satellite count should be no less than 10. Positioning accuracy may vary by +/-2 meters. Complete the remaining steps by walking with the remote controller following the same instructions as the Fly the Aircraft section.

### Handheld RTK

Users should walk along the boundary of the field or the obstacles with the D-RTK 2 Mobile Station for measurements. Make sure that the aircraft is powered off when planning your flight route.

1. Refer to the D-RTK 2 Mobile Station User Manual to link the remote controller and the mobile station. Make sure that the mobile station is the device currently controlled by the remote controller.
2. In the app, tap Field Plan and select Handheld RTK.
3. Make sure that the RTK status is FIX. Complete the remaining steps by walking with the mobile station following the same instructions as the Fly the Aircraft section.

### DJI Terra

1. Make sure to read the DJI Terra User Manual for field planning before sharing the planned data to DJI AG Platform or storing the data to the microSD card in the remote controller.
2. Using the planning data
  - a. Download from the DJI AG Platform:  
To view the data on the platform, go to the main screen of DJI MG2 and tap  to synchronize data. Select the desired data for field editing.
  - b. Import from the microSD card:  
Make sure that the remote controller is powered off. Insert the microSD card with the planning data from DJI Terra into the microSD card slot on the T16 remote controller. Next, go to the home screen of DJI MG2. Select the data in the prompted window and import it. To view the data, go to  task management on the home screen. Select the desired data for field editing.

### Field Editing

Tap any blank space on the onscreen map to enter Edit Status.

#### 1. Edit Waypoints

Move: Drag the waypoint to move.

Fine Tuning: Tap the waypoint to show Fine Tuning buttons. Tap to adjust.

Delete: Tap twice to delete a waypoint.

#### 2. Adjust Route

Route Direction: Tap and drag the  icon near the route to adjust the flight direction of the planned route. Tap the icon to show the Fine Tuning menu and adjust.

Line Spacing: Tap the  icon at the top of the screen to adjust the line spacing between two neighboring lines.

Collision Avoidance Safety Margin: Tap the corresponding button on the bottom of the screen, and adjust the safety margin between the route and the edge of the field or obstacle.

Tap any edge of the operation area twice to align the flight direction to the edge, and adjust the single collision avoidance safety margin for the corresponding edge.

#### 3. Edit Obstacles

To choose the shape and size of the obstacle in the menu, tap and hold the marked obstacle or the position needed to mark an obstacle on the screen.

Tap the obstacle on the screen which has waypoints added, then follow the Edit Waypoints instructions to edit the added waypoints for complete obstacle information.

#### 4. Tap Save Field, name the operation, choose crop, and configure other parameters.

## Performing an Operation

1. Power on the remote controller. Place the aircraft at one of the previously set calibration points and power it on.
2. Go to the home screen in DJI MG2 and tap Execute Operation to enter the Operation View.
3. Tap  to select a field in Fields tag, and tap Invoke.
4. Adjust route: adjust the route direction, line spacing, collision avoidance safety margin, and height above crops.
5. Tap Rectify Offset and then Rectify Aircraft Position, or adjust the route position via the Fine Tuning buttons and tap OK.
6. Tap Start, set operation parameters, and tap OK.
7. Take off and perform the operation.
  - ① If you fly to the targeted height, move the slider to start spraying.
  - ② If the aircraft is on the ground, set an appropriate auto-takeoff height, move the slider to take off, and start spraying.



- Only take off in open areas and set an appropriate auto-takeoff height according to the operating environment.
  - The operation is automatically cancelled if the motors are started before beginning the operation. You will need to recall the operation in the task list.
  - Once started, the aircraft flies to the starting point of the route and locks its heading in the direction of the first turning point for the duration of the flight route. During operation, users cannot control the aircraft heading via the control stick.
  - The aircraft does not spray while flying along line spacing, but automatically sprays while flying along the rest of the route. In DJI MG2, users can adjust the height above vegetation and the operation efficiency, which affects the flying speed and spray rate.
  - An operation can be paused by toggling the Pause switch. The aircraft hovers and records the breakpoint, and then the aircraft can be controlled manually. To continue the operation, select the breakpoint again from the Executing tag in the operation list, and the aircraft will return to the breakpoint automatically and resume the operation. Pay attention to aircraft safety when returning to a breakpoint.
  - The aircraft hovers at the endpoint of the flight route after the operation is completed. Instead of hovering, the aircraft can also be set to perform other actions in the app.
- 

## A-B Route Operation Mode

In A-B Route operation mode, the aircraft travels along a pre-planned route. Operation resumption, data protection, altitude stabilization, obstacle avoidance, and auto bypassing functions of the radar module are available in this mode. Use the app to adjust operation efficiency, which affects the flying speed and spray rate. A-B Route operation mode is recommended for large, rectangular spray areas.

## Operation Route

The aircraft travels along a planned square zig-zag route after recording turning points A and B. Under optimal working conditions, the obstacle avoidance and auto bypassing functions are available and the aircraft maintains the same distance from the vegetation. The length of the dotted lines, called line spacing, can be adjusted in DJI MG2.

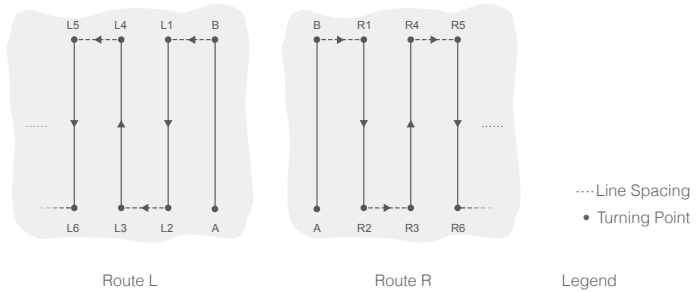

### Operation Procedure

-  • Maintain VLOS of the aircraft at all times.
- Make sure that the GNSS signal is strong. Otherwise, A-B Route operation mode may be unreliable.

-  • Make sure to inspect operating environments before flying.

Set the operation mode switch button to M (Manual operation mode) when a strong GNSS signal is present and the onscreen display is Manual Route (GNSS) or Manual Route (RTK). Fly the aircraft to a safe height.

#### 1. Record Points A and B in order

Fly the aircraft to the starting point, depicted as Point A or B, hover, and press Button A or B on the remote controller or tap Point A or B onscreen. The icon for Point A or B changes from gray to purple and the aircraft status indicators blink red or green after recording the starting points.

-  • Points A and B cannot be recorded if the spray tank is empty.
- Make sure to record Point A first, and then Point B, and ensure that the distance between Point A and B is greater than 1 m.
- Update Point B by flying the aircraft to a new position to record. Note that if Point A is updated, Point B must be too.
- For optimal performance, it is recommended to keep the direction of Point A to B parallel to one side of the rectangular spray area.

-  • After recording Point A, there will be a menu prompt for operation type include settings such as pesticide per acre, operation type, and banked turning. Move the slider to adjust operation efficiency. During the operation, tap the icon at the top of the screen to adjust parameters. You can also adjust operation efficiency via the settings dial on the remote controller.
- DJI MG2 displays the line spacing icon after Point A and B are recorded. Tap to adjust the value. Line spacing cannot be adjusted during operation. Switch to Manual operation mode to adjust the value, then go back to A-B Route operation mode.

2. Select the Route

After Point A and B are recorded, the app produces Route R by default. Tap Change Direction on the lower right corner of the screen to switch to Route L and tap OK. Tap Direction to show the direction adjustment menu again.

3. Configuring Aircraft Altitude

Tap  at the top of the screen to set the desired height above vegetation. Under optimal working conditions, the radar module starts working automatically and maintains the spraying distance between aircraft and vegetation after performing the operation. Refer to [DBF Imaging Radar \(p. 23\)](#) for more information.

4. Performing an Operation

Tap Start at the lower right corner of the screen and move the slider to begin the operation.



- If, after recording Points A and B, you fly the aircraft more than five meters away from Point B, Resume appears at the lower right corner of the screen. Tap Resume, and the aircraft automatically flies to Point B to perform the operation.
- If the GNSS signal is weak during the operation, the aircraft enters Attitude mode and exits from A-B Route operation mode. Operate the aircraft with caution. The operation can be resumed after the GNSS signal is recovered.



- If you press the A or B button during operation while the flying speed of the aircraft is lower than 0.3 m/s, the data for Points A and B of the current route is erased and the aircraft hovers in place.



- Line spacing can be customized from 3-10 m in DJI MG2. It is set to a length of 5 m by default.
- The nose of the aircraft points from Point A to Point B regardless of flight direction. Users cannot control the aircraft heading via the control stick during the operation.
- When using the control sticks to control the aircraft in A-B Route operation mode, the aircraft automatically switches to Manual operation mode, completes the corresponding flight behavior, and then hovers. To resume the operation, tap Resume onscreen. The aircraft resumes flying along the operation route. Refer to [Operation Resumption \(p. 20\)](#) for more information.
- Even though the heading of the aircraft cannot be adjusted, use the control sticks to avoid obstacles if the obstacle avoidance function of the radar module is disabled. Refer to [Manual Obstacle Avoidance \(p. 21\)](#) for more information.
- During the operation, the aircraft does not spray liquid while flying along the direction of the line spacing, but automatically sprays liquid while flying along the other parts of the route.

## Manual Operation Mode

Tap the operation mode switch button in the app and select M to enter Manual operation mode. In this mode, you can control all the movements of the aircraft, spray liquid via the spray button of the remote controller, and adjust the spray rate via the dial. Refer to [Controlling the Spraying System \(p. 32\)](#) for more information. Manual operation mode is ideal when the operating area is small.

## Manual Plus Operation Mode

Tap the operation mode switch button in the app and select M+ to enter Manual Plus operation mode. In this mode, the maximum flying speed of the aircraft is 7 m/s (customizable in DJI MG2), the heading is locked, and all other movement can be manually controlled. Users can disable the M+ heading lock in the app. Under optimal working conditions, the radar module maintains the spraying distance between aircraft and vegetation if the altitude stabilization function is enabled. Press the corresponding buttons onscreen or C1 or C2 buttons on the remote controller (if customized) to steer the aircraft left or right. The aircraft automatically sprays when accelerating forward, backward or diagonally, but does not spray when flying sideward. Manual Plus operation is ideal for irregularly-shaped operating areas.

---



- The line spacing cannot be adjusted during operation. Switch to Manual operation mode to adjust the value, then go back to Manual Plus operation mode.
  - The spray rate will be adjusted automatically according to the flying speed.
  - In DJI MG2, users can adjust the height above the vegetation and the operation efficiency, which affects the maximum flying speed and maximum spray rate.
  - Fly with caution when steering the aircraft using the app or the C1 or C2 buttons as obstacles on either side of the aircraft may not be detected if they are in the blind spots of the radar module.
- 

## Operation Resumption

When exiting a Route or an A-B Route operation, the aircraft records a breakpoint. The Operation Resumption function allows you to pause an operation temporarily to refill the spray tank, change the battery, or avoid obstacles manually. Afterwards, resume operation from the breakpoint.

### Recording a Breakpoint

Users can record the location of an aircraft as a breakpoint. If the GNSS signal is strong, exit a Route or A-B Route operation through one of the following methods to record a breakpoint.

1. Tap the Pause or End button at the lower right corner of the screen. Note: tapping the End button during an A-B Route operation does not make the aircraft record a breakpoint. The operation ends immediately and cannot be resumed.
2. Initialize RTH.
3. Toggle the pause switch.
4. Push the pitch or roll stick in any direction on the remote controller.
5. Obstacle detected. The aircraft brakes and enters obstacle avoidance mode.
6. Radar module error detected when the obstacle avoidance function is enabled.
7. The aircraft reaches its distance or altitude limit.
8. Empty tank.
9. If the GNSS signal is weak, the aircraft enters Attitude mode and exits the Route or A-B Route operation. The last position where there was a strong GNSS signal is recorded as a breakpoint.

- ⚠ • Make sure that the GNSS signal is strong when using the Operation Resumption function. Otherwise, the aircraft cannot record and return to the breakpoint.
- The breakpoint is updated as long as it meets one of the above conditions.
- If the operation is paused for longer than 20 minutes during an A-B Route operation, the system automatically switches to Manual operation mode and erases the breakpoint.

## Resuming Operation

1. Exit a Route or A-B Route operation through one of the above methods. The aircraft records the current location as the breakpoint.
2. Fly the aircraft to a safe location after operating the aircraft or removing the conditions for recording a breakpoint.
3. Tap Resume at the lower right corner of the screen to continue the operation. To resume operation when the end button has been used to exit a Route operation, select the Executing tag in the operation list and then select the operation.
4. Return Route

There will be prompt in DJI MG2. Users can select from returning to the breakpoint or returning to the operating route at the nearest possible junction by following a perpendicular line.

5. If obstacle avoidance is required when returning to the route, users can enable the aircraft to move forward, backward, and sideward. Refer to the Manual Obstacle Avoidance section for more information.

## Typical Applications

In Route or A-B Route operation mode, users can control the aircraft forward, backward, and sideward, avoiding obstacles along the operation route, or in an emergency such as when the aircraft is experiencing abnormal behavior. The following instructions describe how to avoid obstacles manually:

## Manual Obstacle Avoidance

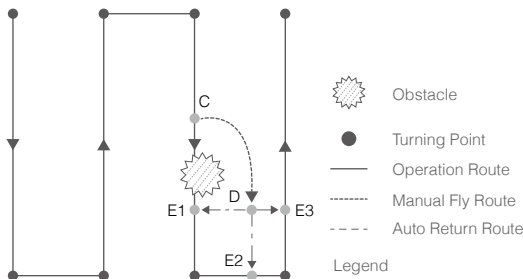

1. Exiting a Route or A-B Route operation

In both modes, when using the control sticks to control the aircraft forward, backward, or sideways, the aircraft automatically switches the current mode to Manual operation mode, pauses the operation, records the current position as a breakpoint (Point C), completes the corresponding flight behavior, and hovers.

---

 When pushing the control sticks to exit the operation, the aircraft requires a braking distance. Make sure that there is a safe distance between the aircraft and any obstacles.

---

2. Avoiding an Obstacle

After switching to Manual operation mode, users can control the aircraft to avoid the obstacle from Point C to D.

3. Resuming Operation

Tap Resume in DJI MG2. If the aircraft is in the operating area, there will be a prompt in DJI MG2. Select among the three project points E1, E2, or E3. The aircraft flies from Point D to the selected project point following a perpendicular line.

- 
-  • The amount of selectable project points is related to the position of the aircraft. Select according to the app display.
- Make sure that the aircraft has completely avoided the obstacle before resuming operation.
  - In the event of an emergency, make sure that the aircraft is operating normally and fly the aircraft manually to a safe area to resume operation.
- 

 Repeat the instructions above to exit and resume operation in the event of an emergency when returning to the route, such as whenever obstacle avoidance is required.

---

## System Data Protection

In Route or Route A-B operation mode, the System Data Protection feature enables the aircraft to retain vital system data such as operation progress and breakpoints after the aircraft is powered off to replace a battery or refill the spray tank. Follow the instructions in Operation Resumption to resume the operation after restarting the aircraft.

During Route operations, in situations such as when the app crashes or the remote controller disconnects from the aircraft, the breakpoint will be recorded by the flight controller and can be recovered in the app once the aircraft is reconnected. Go to Operation View, select ●●●, , then Advanced Settings, and tap Continue Unfinished Task. Recall the operation in Executing tag in operation list.



## DBF Imaging Radar

### Profile

The all-new DBF imaging radar works during both day and night, without being affected by light or dust. In an optimal operating environment, the radar module can predict the distance between the aircraft and the vegetation or other surfaces in forward, rear, and downward directions to fly at a constant distance to ensure even spraying and terrain following capability. The DBF imaging radar can also detect obstacles 30 m away from the aircraft. The radar module adopts digital beam forming technology, which supports 3D point cloud imaging that effectively senses the environment and helps to circumvent obstacles in both Route and A-B Route operation modes. In addition, radar module limits the descent speed of the aircraft according to the distance between the aircraft and ground, to provide a smooth landing.

The altitude stabilization and obstacle avoidance functions of the radar module are enabled by default, and can be disabled in the app. When enabled, the aircraft flies above the vegetation at a constant spraying distance in Route, A-B Route, and Manual Plus operation modes. In Manual operation mode, the radar module can also measure the spraying distance above the vegetation or other surfaces, but the aircraft is not be able to fly at a constant spraying distance. The obstacle avoidance function can be used in any mode. Auto Bypass is disabled by default. Users can enable it in the app.

### Detection Range

The detection range of the radar module is depicted as follows: The horizontal detection range is  $\pm 50^\circ$  and the vertical detection range is  $0^\circ$  to  $10^\circ$ , as shown below. Note that the aircraft cannot sense obstacles that are not within the detection range. Fly with caution.

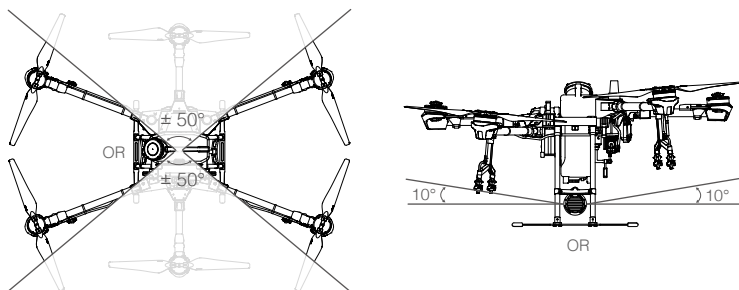

### Obstacle Avoidance Function Usage

- ⚠ The effective horizontal detection range varies depending on the size and material of the obstacle. For example, when sensing objects that have a radar cross section (RCS) of -5 dBsm, the effective horizontal detection range is approximately  $\pm 38^\circ$ . When sensing objects such as power lines that have a RCS of -10 dBsm, the range is approximately  $\pm 28^\circ$ . When sensing objects such as dry trees branches that have a RCS of -15 dBsm, the range is approximately  $\pm 14^\circ$ . Obstacle sensing may malfunction or be unavailable in areas outside of the effective detection range.

Obstacle avoidance is used in the following two scenarios:

1. The aircraft begins to decelerate when it detects an obstacle is 15 m away and hovers in place when 2.5 m away from the obstacle. Users can not accelerate in the direction of the obstacle, but can fly in a direction away from the obstacle.
2. The aircraft immediately brakes and hovers if it detects an obstacle nearby. Users cannot control the aircraft when it is braking.

When the aircraft is hovering, it is in Obstacle Avoidance mode. Users can fly in a direction away from the obstacle to exit Obstacle Avoidance mode and regain full control of the aircraft.

---

 Obstacle avoidance during RTH is different from the above descriptions. Refer to [Obstacle Avoidance During RTH \(p. 27\)](#) for more information.

---

### Altitude Stabilization Function Usage

1. Make sure that you have enabled the altitude stabilization function of the radar module in DJI MG2.
2. Enter the desired operation mode, and configure the desired spraying distance.
3. If the operating environment is ideal, the aircraft flies above the vegetation at the preset height.

### Obstacle Circumvention Function Usage

1. Make sure that you have enabled the obstacle avoidance function of the radar module in DJI MG2, and enable Auto Bypass. (Auto Bypass is disabled if Obstacle Avoidance is disabled.)
2. Perform a Route or A-B Route operation. During auto flight, when obstacles are detected, the aircraft plans a flight route to circumvent the obstacles, and the app shows the real-time obstacle radar map and planned flight route.
3. The aircraft flies along the planned flight route to circumvent the obstacles. Once the obstacles are circumvented, the aircraft returns to the operation route.
4. The aircraft hovers in place if a prompt is received in the app indicating that the aircraft failed to circumvent the obstacle. Users can manually control the aircraft to avoid the obstacles. Refer to [Manual Obstacle Avoidance \(p. 21\)](#) for more information.

### Radar Usage Notice

---

-  • DO NOT touch or let your hands or body come in contact with the metal parts of the radar module when powering on or immediately after flight as they may be hot.
  - In Manual operation mode, users have complete control of the aircraft. Pay attention to the flying speed and direction when operating. Be aware of the surrounding environment and avoid the blind spots of the radar module.
  - Obstacle Avoidance disabled in Attitude mode.
  - Obstacle Avoidance is adversely affected when aircraft pitch exceeds 15°. Fly with caution.
  - The radar module enables the aircraft to maintain a fixed distance from vegetation only within its working range. Observe the aircraft's distance from vegetation at all times.
  - Operate with extra caution when flying over inclined surfaces. Recommended maximum inclination at different aircraft speeds: 10° at 1 m/s, 6° at 3 m/s, and 3° at 5 m/s.
-

- 
- ⚠ • Maintain full control of the aircraft at all times. DO NOT rely solely on DJI MG2. Keep the aircraft within VLOS at all times. Use your sound discretion to operate the aircraft manually to avoid obstacles.
  - Comply with local radio transmission laws and regulations.
  - The radar module can only function properly in flat landscapes. It cannot function in sloping landscapes with inclinations more than 10° or in landscapes with sudden changes in elevation.
  - The sensitivity of the radar module may be reduced when operating several aircraft within a short distance. Operate with caution.
  - Before use, make sure that the radar module is clean and the outer protective cover is not cracked, chipped, sunken, or misshapen.
  - DO NOT attempt to disassemble any part of the radar module that has already been mounted prior to shipping.
  - The radar module is a precision instrument. DO NOT squeeze, tap, or hit the radar module.
  - Land the aircraft on flat ground to avoid damage to the radar module from raised objects.
- 
- ☀ • If the radar module frequently detects obstacles incorrectly, first check to make sure the mounting bracket and the aircraft landing gear are properly secured. Second, perform the IMU calibration. If the radar module still does not work, contact DJI Support or a DJI authorized dealer.
  - Keep the protective cover of the radar module clean. Clean the surface with a soft damp cloth and air dry before using again.
- 

## Empty Tank



### Profile

A prompt appears in DJI MG2 and the aircraft hovers in place when the spray tank is empty. In Route, A-B Route, and Manual Plus operation modes the aircraft can also be set to ascend or RTH instead of hovering.

### Usage

1. When an empty tank warning appears in the app, the sprinklers automatically turn off.
2. Make sure that the aircraft is in Manual operation mode. Land the aircraft and stop the motors. Refill the spray tank and tightly secure the cover.
3. Take off in Manual operation mode and fly the aircraft to a safe position. Enter the desired mode to continue the operation.

## Return to Home (RTH)

 **Home Point:** The default home point is the first location where your aircraft received strong GNSS signals  (the white GNSS icon has at least four white bars). The aircraft status indicators blink several times after the home point has been recorded.

**RTH:** RTH brings the aircraft back to the last recorded home point.

---

There are two types of RTH: Smart RTH and Failsafe RTH.

### Smart RTH

Press and hold the RTH button on the remote controller when GNSS is available to enable Smart RTH. Both Smart and Failsafe RTH use the same procedure. With Smart RTH, you may control the speed and altitude of the aircraft to avoid collisions when returning to the home point. The aircraft status indicators will show the current flight mode during RTH. Press the RTH button once or toggle the pause switch to exit Smart RTH and regain control of the aircraft.

### Failsafe RTH

 Failsafe RTH must be enabled in DJI MG2. If Failsafe RTH is disabled, the aircraft hovers in place when the remote controller signal is lost. Note that Failsafe RTH is disabled by default in DJI MG2.

Failsafe RTH is automatically activated if the remote controller signal is lost for more than three seconds, provided that the home point has been successfully recorded, the GNSS signal is strong (the white GNSS icon ) and the RTK module is able to measure the heading of the aircraft. The RTH continues if the remote controller signal is recovered, and users can control the aircraft using the remote controller. Press the RTH button once or toggle the pause switch to cancel RTH and regain control of the aircraft.

### RTH Illustration

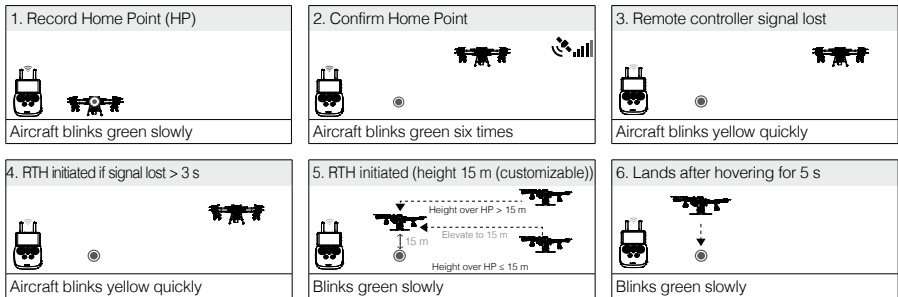





### Updating the Home Point

You can update the home point in DJI MG2 during flight. There are two ways to set a home point:





1. Set the current coordinates of the aircraft as the home point.
2. Set the current coordinates of the remote controller as the home point.

 Make sure the space above the remote controller's GNSS module (located beneath the DJI logo) is not obstructed and that there are no tall buildings around when updating the home point.

Follow the instructions below to update the home point:

1. Go to DJI MG2 and enter Operation View.
2. Tap ●●●, then , and select  in Home Point settings to set the current coordinates of the aircraft as the home point.
3. Tap ●●●, then , and select  in Home Point settings to set the current coordinates of the remote controller as the home point.
4. The aircraft status indicators blink green to indicate that the new home point has been set successfully.

## RTH Safety Notices

	<p>The aircraft cannot avoid obstacles during RTH if the operating environment is not suitable for the radar module. Users can only control the speed and altitude of the aircraft. Before each flight, it is important to set an RTH altitude that is appropriate for the given environment. Go to Operation View in DJI MG2, tap ●●●, then ⚙️, and Set Return to Home Altitude.</p>
	<p>If the aircraft is flying under 5 m and RTH (including Smart and Failsafe RTH) is triggered, the aircraft first automatically ascends to 5 m from the current altitude. You cannot control the aircraft during this ascent. In Smart RTH, you can exit RTH to cancel automatic ascent by pressing the RTH button once.</p>
	<p>The aircraft automatically descends and lands if RTH is triggered when the aircraft flies within a 5 m radius of the Home Point.</p>
	<p>The aircraft cannot return to the home point when the GNSS signal is weak (the GNSS icon displays red) or is unavailable.</p>
	<p>When the RTH altitude is set to more than 3 m and the aircraft is ascending between 3 m and the preset RTH altitude, the aircraft stops ascending and immediately return to the home point if the throttle stick is pushed.</p>

## Obstacle Avoidance During RTH

In an optimal operating environment, obstacle avoidance during RTH is available. If there is an obstacle within 20 m of the aircraft, the aircraft decelerates and then stops and hovers. If the aircraft comes within 6 m of the obstacle while decelerating, the aircraft stops, flies backward to a distance of approximately 6 m from the obstacle, and hovers. The aircraft exits the RTH procedure and waits for further commands.

## Landing Protection Function

Landing Protection activates during auto landing. The procedure is as follows:

1. After arriving at the home point, the aircraft descends to a position 3 m above the ground and hovers.
2. Control the pitch and roll sticks to adjust the aircraft position and make sure the ground is suitable for landing.
3. Pull down the throttle stick or follow the onscreen instructions in the app to land the aircraft.

## Low Battery and Low Voltage Warnings

The aircraft features a low battery warning, critical low battery warning, and critical low voltage warning.

1. **Low Battery Warning:** The aircraft status indicators slowly blink red. Fly the aircraft to a safe area and land it as soon as possible, stop the motors, and replace the batteries.
2. **Critical Battery Warning or Critical Voltage Warning** (the battery voltage is lower than 47.6 V): the aircraft status indicators rapidly blink red. The aircraft begins to descend and land automatically.

 Users can set the threshold of low battery warnings.

## RTK Functions

The T16 has an onboard D-RTK. The heading reference of the aircraft from the dual antennas of the onboard D-RTK is more accurate than a standard compass sensor and can withstand magnetic interference from metal structures and high-voltage power lines. When there is a strong GNSS signal, the dual antennas activates automatically to measure the heading of the aircraft.

The T16 supports centimeter-level positioning to improve agricultural operation when used with the DJI D-RTK 2 Mobile Station. Follow the instructions below to use the RTK functions.

### Enable/Disable RTK

Before each use, make sure that the RTK Function is enabled and the RTK service type is correctly set to either D-RTK Mobile Station or Network RTK Service. Otherwise, RTK cannot be used for positioning. Go to Operation View in DJI MG2, tap , and select RTK to view and set.



Make sure to disable the RTK function if not in use. Otherwise, the aircraft is not be able to take off when there is no differential data.

### Using with the DJI D-RTK 2 Mobile Station

1. Refer to the D-RTK 2 Mobile Station User Guide for more information about completing the linking between the aircraft and the mobile station and the setting up the mobile station.
2. Power on the mobile station and wait for the system to start searching for satellites. The RTK status icon on top of the Operation View in DJI MG2 shows  to indicate that the aircraft has obtained and used the differential data from the mobile station.

### Using with the Network RTK Service

The Network RTK service uses the remote controller instead of the base station to connect to an approved Network RTK server for differential data. Keep the remote controller on and connected to the internet when using this function.

1. Make sure that the remote controller is connected to the aircraft and has access to the internet.
2. Go to Operation View in DJI MG2, tap , and then RTK. Set the RTK service type to Custom Network RTK, and input the network information.
3. Wait for the remote controller to be connected with the Network RTK server. The RTK status icon on top of the Operation View in DJI MG2 shows  to indicate that the aircraft has obtained and used the RTK data from the server.

# Remote Controller

## Profile

The remote controller uses the DJI OcuSync 2.0 dual-band image transmission system, which has a maximum control distance of up to 3.11 mi (5 km). It includes a dedicated, Android-based display that runs DJI MG2 independently for operation planning and aircraft status display. Its Multi-Aircraft Control mode can be used to coordinate the operation of up to five aircraft at the same time to improve operation efficiency.

 Stick mode can be set to Mode 1, Mode 2, and Mode 3 in the app. For beginners, it is recommended to set it to Mode 2.

**Mode 1:** The right stick serves as the throttle.

**Mode 2:** The left stick serves as the throttle.

## Using the Remote Controller

### Turning the Remote Controller On and Off

The remote controller uses a removable, interchangeable Intelligent Battery. The battery level is indicated via the battery level LEDs on the front panel after the battery is mounted.

Follow the steps below to turn on the remote controller:

1. When the remote controller is turned off, press the Power button once to check the current battery level, indicated by the battery level LEDs. If the battery level is too low, recharge before use.
2. Press the Power button once, then press and hold to power on the remote controller.
3. The remote controller beeps when turned on. The status LED glows solid green when linking is complete.
4. Repeat Step 2 to turn off the remote controller.

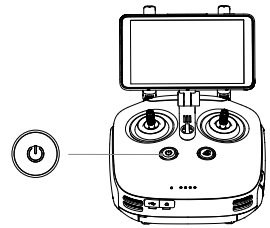

 The remote controller internal backup battery allows users to insert and remove the external Intelligent Battery while the remote controller is still powered on and in use. The device enters Sleep mode to save power. Users are then required to replace the Intelligent Battery within three minutes, or the remote controller powers off.

### Charging the Remote Controller

Charge the Intelligent Battery of the remote controller using the included AC power adapter and charging hub.

1. Place the battery into the charging hub, connect the AC power adapter to the charging hub, and connect the charger to a power outlet (100-240 V, 50/60 Hz).
2. The charging hub automatically charges batteries in order according to the battery power levels from high to low.
3. The Status LED blinks green when charging and turns solid green when fully charged. The charging hub beeps when charging is complete. To stop the beeping, remove the battery or turn off the button on the charging hub.

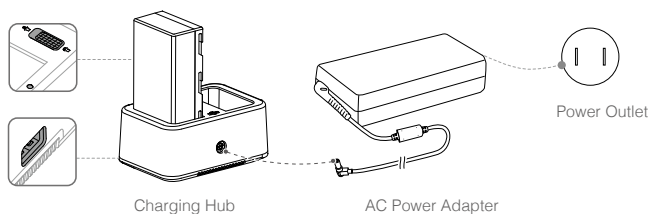

## Operating the Aircraft

This section explains how to control the orientation of the aircraft through the remote controller. Control can be set to Mode 1, Mode 2, or Mode 3.

### Mode 1

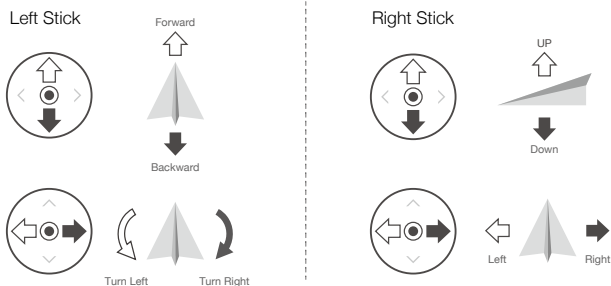

### Mode 2

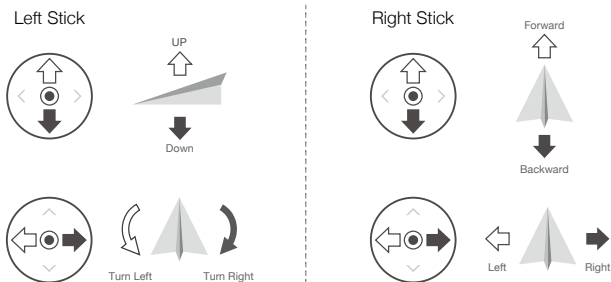



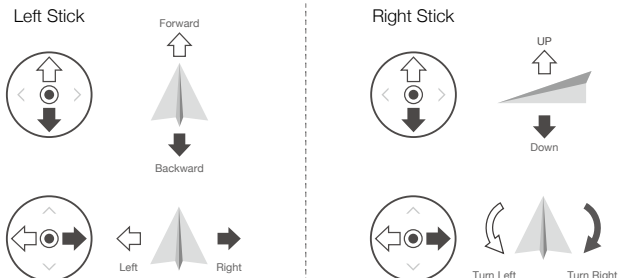

### Mode 3



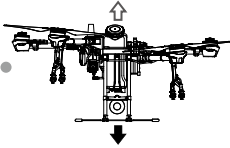
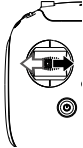
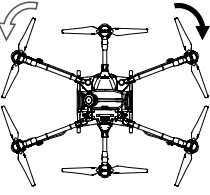

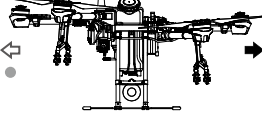
For example, the following description uses Mode 2:

Remote Controller (Mode 2)	Aircraft (● Indicates nose direction)	Remarks
		<p><b>Throttle Stick:</b> Move the left stick vertically to control the elevation of the aircraft.</p> <p>Push up to ascend and push down to descend. Use the left stick to take off when the motors are spinning at an idle speed. The aircraft hovers in place if the stick is in the center position. The further the stick is pushed away from the center position, the faster the aircraft changes elevation.</p>
		<p><b>Yaw Stick:</b> Move the left stick horizontally to control the heading of the aircraft.</p> <p>Push left to rotate the aircraft counterclockwise and push right to rotate clockwise. The aircraft hovers in place if the stick is in the center position. The further the stick is pushed away from the center position, the faster the aircraft rotates.</p>
		<p><b>Pitch Stick:</b> Move the right stick vertically to control the pitch of the aircraft.</p> <p>Push up to fly forwards and press down to fly backwards. The aircraft hovers in place if the stick is in the center position. Push the stick further for a larger pitch angle and faster flight.</p>
		<p><b>Roll Stick:</b> Move the right control stick horizontally to control the roll of the aircraft.</p> <p>Push the stick left to fly left and right to fly right. The aircraft hovers in place if the stick is in the central position. Push the stick further for a larger roll angle and faster flight.</p>

## Controlling the Spraying System

Complete an operation remotely via the spray rate or aircraft control switch dials, or the spray, A/B, and C1 or C2 buttons.

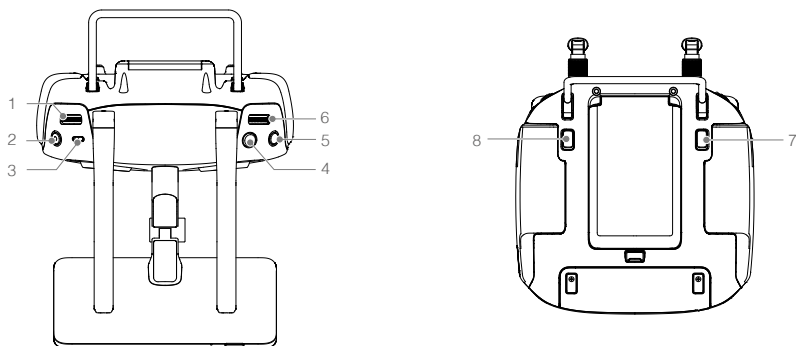

### 1. Spray Rate Dial

In Manual operation mode, turn left to reduce and right to increase the spray rate. \* The app indicates the current spray rate.

\* Spray rate may vary according to the nozzle model and viscosity of the liquid.

### 2. Spray Button

In Manual operation mode, press to start or stop spraying.

### 3. Pause Switch

Toggle to pause the operation in Route or A-B Route operation modes. The aircraft hovers and records the breakpoint. The aircraft can then be controlled manually. To resume a Route operation, select the operation in the app. To resume an A-B Route operation, tap Resume on the screen. The aircraft then returns to the breakpoint automatically and continues the operation.

During RTH, toggle to pause RTH. The aircraft hovers, and then the aircraft can be controlled manually.

### 4. Button A

Records Point A of the operation route in A-B Route operations by default. Use the app to customize the button.

### 5. Button B

Records Point B of the operation route in A-B Route operations by default. Use the app to customize the button.

### 6. Aircraft Control Switch Dial

Turn and press the dial to switch between the aircraft when using the Multi-Aircraft Control function.

### 7. Button C1

When planning a field, press the button to start or end obstacle measurement. The function of the button cannot be customized when planning a field.

When not planning a field, use the app to customize the button.

### 8. Button C2

When planning a field, press the button to add a waypoint. The function of the button cannot be customized when planning a field.

When not planning a field, use the app to customize the button.

The table below is a summary for how to control the spraying system in different modes using the remote controller.

Modes	Spray Rate Dial	Spray Button	Pause Switch	Button A	Button B	Aircraft Control Switch Dial	Button C1	Button C2
Route operation mode	/	/	Pause	Customizable	Customizable	Switch between aircraft	Customizable	Customizable
A-B Route operation mode	/	/	Pause	Customizable	Customizable	/	Customizable	Customizable
Manual operation mode	Adjust spray rate	Start or stop spraying	/	Customizable	Customizable	/	Customizable	Customizable
Manual Plus operation mode	Adjust maximum spray rate	/	/	Customizable	Customizable	/	Customizable	Customizable
Field Plan	/	/	/	/	/	/	Start or end obstacle measurement	Add a waypoint

### RTH Button

Press and hold the RTH button to bring the aircraft back to the last recorded home point. The LED around the RTH Button blinks white during RTH. Users can control aircraft heading while it flies to the home point. Press this button again to cancel RTH and regain control of the aircraft.

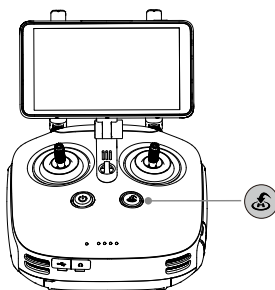

## Optimal Transmission Zone

Optimal Transmission Zone

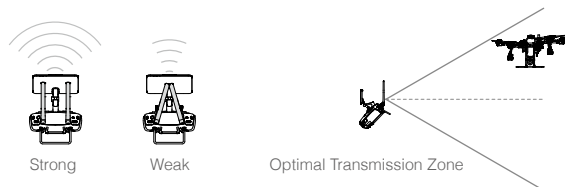

The strength of the remote controller signal is affected by the position of the antennas. The recommended position is perpendicular to the ground. Try to keep the aircraft inside the optimal transmission zone. If the signal is weak, adjust the antennas or fly the aircraft closer.

## Remote Controller LEDs

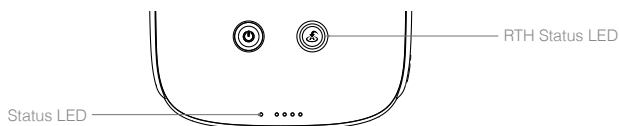

The Status LED indicates the connection status between the remote controller and the aircraft. The RTH status LED indicates the RTH status of the aircraft. See the table below for details on these indicators:

Status LED	Sound	Remote Controller Status
— Solid Red	♪ Chime	The remote controller is not connected to the aircraft.
— Solid Green	♪ Chime	The remote controller is connected to the aircraft.
..... Blinks Red	Beeps slowly repeatedly	Remote controller error.
RTH Status LED	Sound	Aircraft Status
— Solid White	♪ Chime	RTH is initiated.
..... Blinks white	Repeated individual beep	Sending RTH command to the aircraft.
..... Blinks white	Repeated double beep	The aircraft is returning to the home point.

## Linking the Remote Controller

The remote controller is linked to the aircraft by default. Linking is only required when using a new remote controller for the first time. When using Multi-Aircraft Control function, it is required to link all aircraft to the same remote controller.

1. Power on the remote controller and open DJI MG2 . Power on the aircraft.
2. Tap Perform an Operation to enter Operation View and tap ●●●, then . Select Aircraft as the linking device, tap Single Linking or Multi Linking (if Multi-Aircraft Control is in use), and then tap Starting Linking. The status LED blinks blue and the remote controller sounds a repeated double beep, indicating that the remote controller is ready for linking.

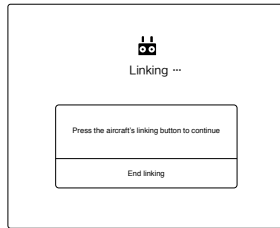

3. Press and hold the power button on the Intelligent Flight Battery for five seconds. The aircraft front LEDs blink red and green alternately, indicating that the linking is in progress.
4. The Status LED on the remote controller glows solid green and the aircraft front LEDs blinks red several times if linking is successful. If linking fails, enter linking status again and retry.
5. Repeat Step 3 and 4 to complete linking between all the aircraft and the remote controller, if Multi Linking is selected. When finished, tap End Linking. Note that up to five aircraft can be linked.

## Multi-Aircraft Control Function

The remote controller features a Multi-Aircraft Control function, which can be used to coordinate the operation of up to five aircraft at the same time, enabling pilots to work very efficiently. It is recommended for large spray areas. Turn the aircraft control switch dial on the remote controller to switch between different aircraft for single control of the desired aircraft.

-  • The Multi-Aircraft Control function can only be used in Route operation mode. Make sure to complete field planning and related configurations before entering the Multi-Aircraft Control mode, since operations of other modes cannot be used except for Route operation mode.
- To avoid interference between operations, do not operate more than three groups within a 50 m radius when using the Multi-Aircraft Control function. Unless using the T16 with a DJI D-RTK 2 Mobile Station, it is necessary to manually configure the serial number of each remote controller in DJI MG2.

## Enter Multi-Aircraft Control Mode

1. Link all the aircraft (up to five) to the same remote controller according to the steps in Linking the Remote Controller.
2. Close the settings menu after linking. The linked aircraft are listed on the left of the screen and sorted by number.

## Switch Control

Users can switch control among different aircraft via the aircraft status box on the left of the screen in the app or the aircraft control switch dial on the remote controller.





### Switch in the App

Tap the status box of the corresponding number in the app. The side of the box turns blue and the aircraft front LEDs blink red quickly, indicating the corresponding aircraft has been selected.

### Switch by the Dial

1. Turn the aircraft control switch dial on the remote controller. There will be an arrow near the corresponding status box in the app, and the aircraft front LEDs blink yellow quickly, indicating the corresponding aircraft is in the pre-selected status.
2. Press the dial once. The side of the box in the app turns blue and the aircraft front LEDs blink red quickly, indicating the corresponding aircraft has been selected.

### Multi-Aircraft Operations

1. Select the desired aircraft by switching control.
2. Tap the status box of the selected aircraft, then tap  on the left of the screen, or tap  on top of the screen to select and use an operation in the later Field tag. Perform the operation after tapping Rectify Offset and setting operation parameters. The selected flight routes data are uploaded to the aircraft.
3. Invoke an operation for each aircraft. Tap  to show the status boxes of all the aircraft and tap another status box to switch to the corresponding aircraft.
4. Tap Start after invoking operations for all aircraft. To launch the aircraft individually, users can move the sliders for each aircraft in the prompt. To make all aircraft takeoff at the same time, move the slider at the bottom of the screen.
5. If there is any emergency during operation, toggle the pause switch on the remote controller to brake all the aircraft. All Route operations will be paused and the aircraft hovers in place and can be controlled manually. To continue the operation, users should invoke the operation again in the Executing tag in the  icon.



During multi-aircraft operations, aircraft automatically avoid each other based on positioning information. When the distance between aircraft is 15 m, they slow down, and when the distance is 5 m, the aircraft are not be able to fly any closer to each other.

---

### Exit from Multi-Aircraft Control Mode

Users can exit from the mode using the following three methods.

Method 1: Link the remote controller to only the desired aircraft. Refer to the Linking the Remote Controller section and follow the instructions for Single-Device Pairing.

Method 2: In the Linked Aircraft list, delete other aircraft and leave only the desired aircraft. The remote controller will control this aircraft only and can perform the operations of other operation modes.

Method 3: Power off the other aircraft that are not required to be controlled and power on the desired aircraft. The remote controller will control this aircraft only and can perform the operations of other operation modes. Note: If the other aircraft are powered on again, the remote controller and the linked aircraft will enter Multi-Aircraft Control mode automatically. To exit Multi-Aircraft Control mode completely, use Method 1 or 2.

# DJI MG2 App

DJI MG2 is designed for agricultural applications and is able to display the system status and configure various settings. After planning a field via the intelligent operation planning system of the app, the aircraft can operate automatically following the pre-planned flight route.

## Home Screen

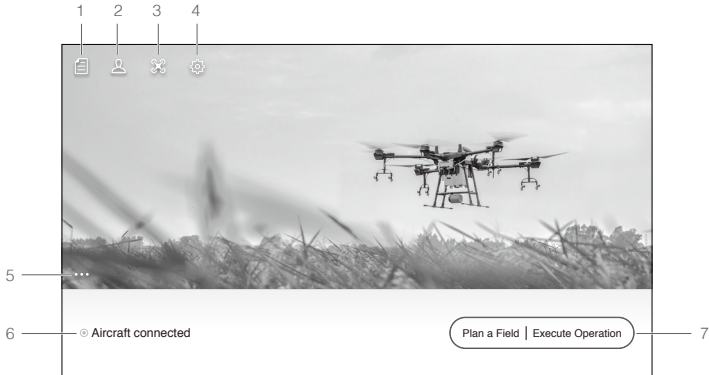

### 1. Task Management

 : View planned fields and operation progress. You can synchronize the local data with the data on the DJI AG Platform.

### 2. User Info

 : View account information.

### 3. Aircraft Info

 : View the information of the connected aircraft such as the firmware version.

### 4. General Settings

 : Tap for settings such as units of measurement, network diagnosis, and Android system settings.

### 5. More

 : Includes FAQ and available firmware update.

### 6. Aircraft Connection Status

 : Shows if the aircraft is connected to the remote controller.

### 7. Plan a Field | Execute Operation

Plan a Field: Tap the button and select planning method to plan a field.

Execute Operation: Tap to enter Operation View to view the aircraft status, configure settings, and switch between different operation modes.

Operation View

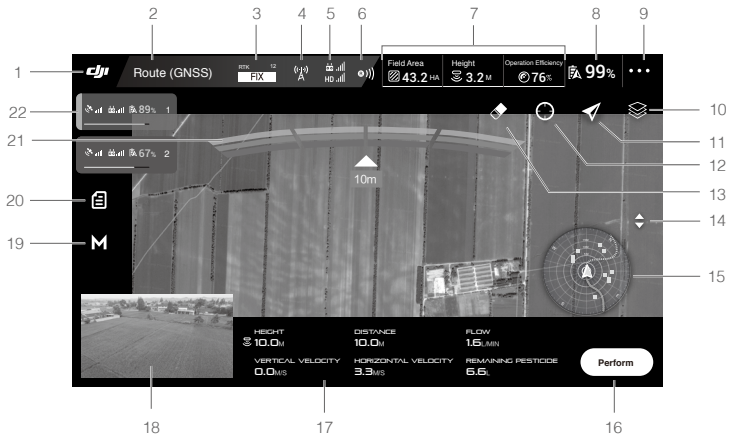

1. Home Screen

**DJI** : Tap this icon to return to the home screen.

2. System Status

**Route (GNSS)** : Indicates current flight modes, operation modes, and warning messages.

3. RTK/GNSS Signal Strength

**FIX** : This icon is displayed when RTK is enabled and works normally. On the left upper corner is the number of satellites connected. One of the following two icons is displayed below the RTK icon: **FIX** indicates that the differential data calculation is completed and the aircraft can use RTK for positioning. The aircraft can only take off in this status. **FLOAT** indicates that the system is calculating the differential data. Wait for **FIX** to be displayed.

**GNSS** : This icon is displayed when RTK is not in use. It shows the current GNSS signal strength and the number of satellites connected.

4. RTK Status

Icons displayed when using RTK data. The display varies when using the D-RTK 2 or Network RTK Service.

**RTK 2** : Displays RTK signal strength when using the D-RTK 2.

**RTK 2 Abn** : Indicates that the connection with the D-RTK 2 is abnormal. Refer to the prompts in the app.

**Network RTK** : Displays RTK signal strength when using the Network RTK Service.

**Network RTK Abn** : Indicates that the connection with the Network RTK server is abnormal. Refer to the prompts in the app.



5. Control and Image Transmission Signal Strength

 : Shows the signal strength of the control and image transmission connection between the aircraft and the remote controller.

6. Radar Module Obstacle Avoidance Function Status

 : Shows the working status of the obstacle avoidance function.

7. Operation Parameters

Shows parameters of current spraying operation. The display varies according to the operation mode.

 : Field Area - Shows the total plan area value when planning fields for Route operations via the intelligent operation planning system.

 : ① Plan Area - Shows the value of the actual area of the planned flight route after planning fields. The area is planned using the following formula: Plan Area = Field Area - Obstacle Area - Collision Avoidance Safety Margin zone ② Sprayed Area - Shows the value of the area already sprayed.

 : Obstacle Area - Shows the area value of the obstacles measured when planning fields for Route operations.

 : Operation Type and Efficiency - Shows operation type and efficiency settings in Route, A-B Route, or M+ mode. Tap to set Pesticide Usage for Spray, and move the slider to adjust operation efficiency.

 : Height - When the altitude stabilization function of the radar module is enabled, this icon shows the preset height between the aircraft and the object underneath the aircraft. The icon appears in all modes except Manual operation mode. Tap to adjust the height.

 : Line Spacing - Shows the preset distance when flying left or right in Route, A-B Route or M+ mode. Tap to adjust the value. Note that for Route operations, the value can only be adjusted before performing an operation.

8. Battery Settings

 99% : Shows the current battery level. Tap to set the low battery warning threshold and view battery information.

9. More Settings

Tap ●●● to enter the extended menu to view and adjust the parameters of all other settings.

 : Aircraft Settings - Includes setting home points, the maximum altitude, maximum flight distance limit, and the action after completing spraying and completing operations, whether to lock the heading in Manual Plus operation mode, setting the aircraft behavior and whether to abort operation when the remote controller signal is lost, and viewing the unlock certificate list.

 : Spraying System Settings - Includes real-time data, nozzle model, flow, air detector calibration, and pesticide placement point.

**RTK** : RTK Settings - Includes aircraft RTK positioning, RTK service type, and advanced settings.

 : Radar Settings - Includes setting the height, obstacle avoidance radar, terrain mode, obstacle display mode, and detection angle.

 : RC Settings - Includes RC calibration, stick mode, RC custom key, pairing mode, linked aircraft, and RC ID.

**HD** : Image Transfer Settings - Includes channel mode and sweep frequency chart selection.

 : Aircraft Battery - Includes low battery warning, low voltage warning, and battery information.

**•••** : General Settings - Includes map settings, flight route display, and FPV settings.

10. Map Mode

 : Tap to switch between Standard, Satellite, or Night modes.

11. Location Follow

 : Tap to update the location and keep the aircraft centered in the map.

12. Location

 : Tap to center the map around the location of the aircraft or the latest recorded home point.

13. Clear Screen

 : Tap to clear the flight route currently shown on the map.

14. Map Zoom In/Out

 : Tap to show the slider. Move the slider to zoom in or out.

15. Obstacle Radar Map

During Route or A-B Route operations, the icon shows the nearby obstacles and planned flight route using the auto obstacle avoidance function, if obstacles are detected when auto bypass is enabled.

16. Operation Control Buttons

Used to control the aircraft during different operation types, including measuring an operation area and invoking, starting, pausing, or ending an operation.

17. Flight Parameters

 **HEIGHT** : When the altitude stabilization function of the radar module is enabled, flight parameters shows the preset height between the aircraft and the object underneath the aircraft.

**DISTANCE** : Horizontal distance from the aircraft to the home point.

**VERTICAL VELOCITY** : Movement speed across a vertical distance.

**HORIZONTAL VELOCITY** : Movement speed across a horizontal distance.

**FLOW** : Pesticide flow rate.

**REMAINING PESTICIDE** : The remaining amount of the pesticide.

18. FPV Camera View



Displays the real-time image from the FPV camera. Tap to switch between the Map View and the Camera View.

19. Operation Mode Switch Button

**M / M<sup>+</sup> / AB** : Tap to switch between Manual (M), Manual Plus (M+), and A-B Route (AB) operation modes.

20. Operation List/Point A/B

 : Operation List - Icon displayed in M operation mode. Tap to view the planned fields and operations in progress and invoke operations.

 : Point A/B - Icon displayed in A-B Route operation mode. Tap to record Point A or B. The color of the icon changes from grey to purple to indicate the point was recorded successfully. Tap  to clear the recorded Point A and B.

21. Obstacle Detection Status

Shows information on the detected obstacles when the obstacle avoidance function of the radar module is enabled. Information regarding obstacles detected in front of the aircraft appears on the top of the screen, and the obstacles detected at the rear of the aircraft is displayed at the bottom of the screen. Red, orange, yellow, and green bars indicate the distance of obstacles. The value indicates the distance between the aircraft and the nearest obstacle.

22. Aircraft Status Box in Multi-Aircraft Control Mode

Displays the status of all connected aircraft sorted by number when using the Multi-Aircraft Control function. Tap to switch the selected aircraft and the left side of the box turns blue.

# Flight

## Operation Environment

1. DO NOT use the aircraft to spray in winds exceeding 18 kph (11 mph).
2. DO NOT use the aircraft in adverse weather conditions such as winds exceeding 28 kph (17 mph), heavy rain (precipitation rate exceeding 25 mm (0.98 in) in 12 hours), snow, or fog.
3. Only fly in open areas. Tall buildings and steel structures may affect the accuracy of the compass and the GNSS signal.
4. Pay attention to utility poles, power lines, and other obstacles. DO NOT fly near or above water, people, or animals.
5. Maintain VLOS of the aircraft at all times, and avoid flying near obstacles, crowds, animals, and bodies of water.
6. Avoid flying in areas with high levels of electromagnetism, including mobile phone base stations and radio transmission towers.
7. The recommended maximum operating altitude is 2 km (6,560 ft) above sea level. DO NOT fly over 3 km (9,842 ft) above sea level.
8. Once the operating altitude reaches 1 km (3,280 ft), the payload capacity of the spray tank is reduced by 2 kg. For every additional km, the payload capacity will reduce by a further 2 kg.
9. Make sure that there is a strong GNSS signal and the D-RTK antennas are unobstructed during operation.
10. DO NOT operate the aircraft indoors.

## Flight Limits and GEO Zones

Unmanned aerial vehicle (UAV) operators should abide by the regulations from self-regulatory organizations such as the International Civil Aviation Organization, the Federal Aviation Administration, and their local aviation authorities. For safety reasons, flight limits are enabled by default to help users operate this aircraft safely and legally. Users can set flight limits on height and distance.

When operating with a strong GNSS signal, the height and distance limits and GEO Zones work together to monitor flight. With a weak GNSS signal, only the height limit prevents the aircraft from going above 30 meters.

### Maximum Height and Radius Limits

Users can change the maximum height and radius limits in DJI MG2. Once completed, the aircraft flight is restricted to a cylindrical area that is determined by these settings. The tables below show the details of these limits.

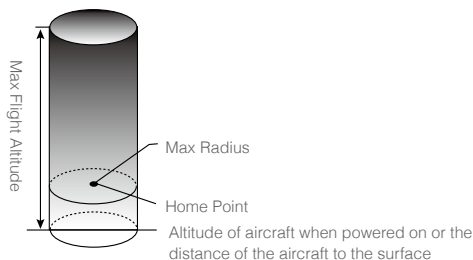

### With a strong GNSS signal

#### Flight Limits

Max Height	Flight altitude must be below the preset height.
Max Radius	Flight distance must be within the max radius.

### With a weak GNSS signal

#### Flight Limits

Max Height	Flight altitude must be below the preset height.
Max Radius	No limit.



- If the aircraft flies into a Restricted Zone, it can still be controlled, but the aircraft can only fly in a backward direction.
- If the aircraft loses GNSS signal and flies out of the max radius but regains GNSS signal later, it will fly back within range automatically.



## GEO Zones

GEO Zones are divided into different categories. All GEO Zones are listed on the DJI official website at <http://www.dji.com/flysafe>.

### GEO Zones are explained below (GNSS required):

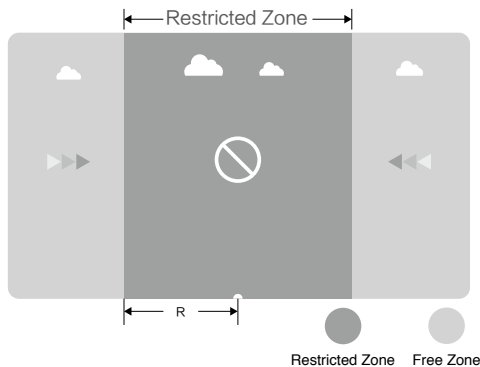
Depending on the local regulation, a certain radius around a marker forms a Restricted Zone, inside of which takeoff and flight are prohibited.



With a strong GNSS signal		
Area	Restriction	Aircraft Status Indicators
Restricted Zone 	Motors will not start.	Blinking Red  .....
	If the aircraft loses GNSS signal and enters a Restricted Zone but regains GNSS signal later, the aircraft will enter semi-automatic descent and land.	
No Flight Restrictions 	Users can fly their aircraft freely.	None.

 Semi-Automatic Descent: All stick commands except the throttle stick command are available during descent and landing. Motors automatically stop after landing.

-  • When operating in Restricted Zones, the aircraft status indicators blink red slowly and continue for five seconds, and then switch to the current aircraft status for twelve seconds. If the aircraft is still in the Restricted Zone at that point, it switches to blinking red slowly for five seconds again and so on.
- DO NOT fly near airports, highways, railway stations, railway lines, city centers, or other busy areas. Make sure the aircraft is visible at all times.

## Pre-Flight Checklist

1. Make sure the remote controller and aircraft battery are fully charged. The pesticides required are adequate.
2. Make sure the spray tank and Intelligent Flight Battery are firmly in place.
3. Make sure all parts are mounted securely.
4. Make sure all cables are connected properly and firmly.
5. Make sure propellers are securely mounted, that there are no foreign objects in or on the motors and propellers, that the propeller blades and arms are unfolded, and the arm sleeves are firmly tightened.
6. Make sure the spraying system is not blocked in any way.
7. Make sure the sprinkler hoses are clear from bubbles. Discharge any bubbles as they may affect the performance of the sprinkler. Loosen the valve on the side of the spray nozzle and start the pump. Next, tighten the valve and the sprinkler will work properly.

## Calibrating the Spraying System

Make sure to calibrate the spraying system before using for the first time. Otherwise, the spraying performance will be adversely affected.



1. Preparation before calibration: If there are any bubbles in the hoses, discharge them before calibrating. If there are no bubbles, proceed with calibration.
  - ① Fill the spray tank with approximately 10 L of water.
  - ② Loosen all the manual relief valves and press the spray button on the remote controller until the

bubbles in the hoses have been fully discharged.\* Tighten the valves and press the spray button to stop spraying.

\* If the bubbles have still not been fully discharged after an extended period, rotate and remove the valve cover. Reattach the cover once the bubbles have been fully discharged.

## 2. Spraying System Calibration

- ① Make sure that there is more than 6 L of water in the spray tank. In DJI MG2, tap Execute Operation to enter Operation View, tap ●●●, then , and select the correct nozzle model. The standard nozzle is model XR11001VS.
- ② Tap Calibrate. Select the pumps that require calibration and tap Calibration. Note that all four pumps are selected by default.
- ③ Calibration starts automatically. After several minutes, the result of the calibration is displayed in the app.
  - After calibrating successfully, users can proceed with the operation.
  - If calibration fails, tap “?” to view and resolve the problem. Afterwards, select the pump that failed to calibrate.

 During calibration, tap ●●●, then  to cancel. If the calibration is cancelled, the accuracy of the flow meter is based on the data before the calibration was started.

## When to Recalibrate

1. Installing a different nozzle model. Note: Choose the corresponding model in DJI MG2 after replacing nozzles. Go to Operation View, tap ●●●, then  for configuration.
2. Using a liquid of a different viscosity.
3. The error between the actual value and the theoretical value of the completed area is more than 15%.

## Calibrating the Compass

-  • It is important to calibrate the compass. The calibration result affects the flight safety. The aircraft may malfunction if the compass is not calibrated.
- DO NOT calibrate your compass where there is a chance of strong magnetic interference. This includes areas where there are utility poles or walls with steel reinforcements.
- DO NOT carry ferromagnetic materials with you during calibration such as keys or mobile phones.
- If the aircraft status indicators show a blinking red light, compass calibration has failed. Please recalibrate.
- After calibrating successfully, the compass may be abnormal when you place the aircraft on the ground. This may be because of underground magnetic interference underground. Move the aircraft to another location and try again.

Calibrate the compass when prompted by the app. It is recommended to calibrate the compass with an empty tank

1. Tap ●●●, then , move the slider to the bottom, and select Advanced Settings, then Sensors. Tap Calibration in the compass calibration section.

2. Hold the aircraft horizontally and rotate it 360° around a vertical axis with the aircraft approximately 1.2 m above the ground. Calibration is completed when the app displays that calibration was successful.

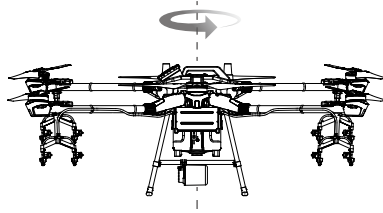

3. If the app displays a tilted aircraft, it indicates that the horizontal calibration failed. Users should tilt the aircraft and rotate it horizontally. Calibration is completed when the app displays that calibration was successful. (To reduce the number of rotations required, the aircraft should be tilted at least 45°.)

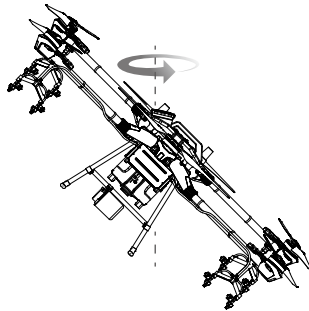

4. If calibration continues to fail, recalibrate the compass from Step 1.



## Starting and Stopping the Motors

### Starting the Motors

The Combination Stick Command (CSC) listed below is used to start and stop the motors. Make sure you perform the CSC in one continuous motion. The motors begin to accelerate at an idle speed. Release both sticks simultaneously. Take off immediately once the motors are spinning, or else the aircraft may lose balance, drift, or even takeoff by itself and risk causing damage or injury.

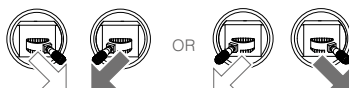

### Stopping the Motors

There are two methods to stop the motors.

1. When the aircraft has landed, push and hold the throttle stick down. The motors will stop after three seconds.



Throttle Stick (left stick in Mode 2)

2. When the aircraft has landed, push the throttle stick down, and perform the same CSC that was used to start the motors. Release both sticks once the motors have stopped. Release both sticks once the motors have stopped.

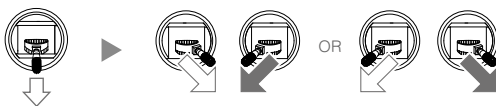

Throttle Stick

- 
- ⚠ • Spinning propellers can be dangerous. Stay away from spinning propellers and motors. DO NOT start the motors in confined spaces or when there are people nearby.
  - Keep your hands on the remote controller when the motors are spinning.
  - DO NOT stop the motors mid-flight unless in an emergency situation where doing so will reduce the risk of damage or injury.
  - Method 1 is the recommended method for stopping the motors. When using Method 2 to stop the motors, the aircraft may roll over if it is not completely grounded. Use Method 2 with caution.
  - After landing, power off the aircraft before turning off the remote controller.
-

## Flight Test

1. Place the aircraft on open, flat ground with the aircraft status indicators facing toward you.
2. Pour liquid into the spray tank, and tighten the cover. Make sure that the four lines on the cover are aligned to the horizontal or vertical direction.

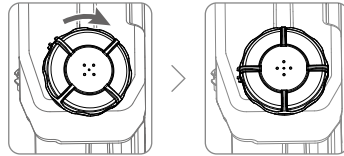

3. Power on the remote controller, make sure that DJI MG2 is open, and then power on the aircraft.
4. Make sure that the aircraft is connected to the remote controller.
5. If using RTK for positioning, make sure that the RTK function is enabled and RTK service type is correctly set (D-RTK 2 Mobile Station or Network RTK service). Go to Operation View in DJI MG2, tap ●●● and select RTK to view and set.

Make sure to disable the RTK function if it is not in use. Otherwise, the aircraft is not be able to take off when there is no differential data.

6. Wait for satellites to be searched, make sure that there is a strong GNSS signal, and make sure the aircraft heading measurement using the dual antennas is ready. Perform the CSC to start the motors. (If the dual antennas are not ready after waiting for an extended period, move the aircraft to an open area with a strong GNSS signal.)
7. Push the throttle stick up to take off.
8. Select the desired operation or flight mode and start operation.
9. Exit the operation to manually control the aircraft for landing. Hover over a level surface and gently pull down on the throttle stick to slowly descend.
10. After landing, push the throttle down and hold. The motors stop after three seconds.
11. Power off the aircraft, and then power off the remote controller.



- When the aircraft status indicators rapidly blink yellow during flight, the aircraft has entered Failsafe mode.
- The low battery level warning is triggered when the aircraft status indicators slowly blink red. Fly the aircraft to a safe area and land as soon as possible, stop the motors, and replace the battery. The critical low battery level warning is triggered when the aircraft status indicators rapidly blink red. The aircraft will begin to automatically descend and land.

# DJI Assistant 2 for MG

Configure settings of the basic parameters, copy flight records, and update aircraft and remote controller firmware in DJI Assistant 2 for MG.

## Installation and Launching

1. Download the DJI Assistant 2 for MG installation file from the T16 download page:  
<http://www.dji.com/t16/info#downloads>
2. Install the software.
3. Launch DJI Assistant 2 for MG.

## Using DJI Assistant 2 for MG

### Connecting the Aircraft

Connect the USB-C port on the bottom of the aerial-electronics system of the aircraft to a computer with a USB-C cable, and then power on the aircraft.



Make sure to remove the propellers before using DJI Assistant 2 for MG.



Remove the waterproof cover on the USB-C port before use. Attach the waterproof cover to the port after use. Otherwise, water may enter the port, causing it to short circuit.

---

### Firmware Update

A DJI account is required for firmware updates. Login or register an account.

### Basic Settings

Configure the idle speed of and test the motor.

### Tools

Enter SD card mode and copy the flight record.

### Connecting the Remote Controller

Connect the USB-C port of the remote controller to a computer with a USB-C cable, and then power on the remote controller.

### Firmware Update

A DJI account is required for firmware updates. Login or register an account.



- DO NOT power off the remote controller during the update.
  - DO NOT perform the firmware update while the aircraft is in the air. Only carry out the firmware update when the aircraft is on the ground.
  - The remote controller may become unlinked from the aircraft after the firmware update. Relink the remote controller and aircraft if necessary.
-

# Appendix

## Specifications

<b>Airframe</b>	
Max Diagonal Wheelbase	1883 mm
Dimensions	2509×2213×732 mm (Arms and propellers unfolded)
	1795×1510×732 mm (Arms unfolded and propellers folded)
	1100×570×732 mm (Arms and propellers folded)
<b>Propulsion System</b>	
<b>Motor</b>	
Stator Size	100×15 mm
KV	75 rpm/V
Max Thrust	13.5 kg/rotor
Max Power	2400 W/rotor
Weight	616 g
<b>ESC</b>	
Max Working Current (Continuous)	40 A
Max Working Voltage	58.8 V (14S LiPo)
<b>Foldable Propellers (R3390)</b>	
Diameter × Pitch	33×9 in
Weight (Single propeller)	90 g
<b>Spraying System</b>	
<b>Spray Tank</b>	
Volume	Rated: 15.1 L, Full: 16 L
Operating Payload	Rated: 15.1 kg, Full: 16 kg
<b>Nozzles</b>	
Model	XR11001VS (Standard), XR110015VS (Optional, purchase separately)
Quantity	8
Max Spray Rate	XR11001VS: 3.6 L/min, XR110015VS: 4.8 L/min
Spray Width	4-6.5 m (8 nozzles, at a height of 1.5 - 3 m above crops)
Droplet Size	XR11001VS: 130 - 250 μm, XR110015VS: 170 - 265 μm (Subject to operating environment and spray rate)
<b>Flow Meter</b>	
Measurement Range	0.45 - 5 L/min
Error	< ±2%
Measurable Liquid	Conductivity > 50 μS/cm (Liquids such as water or pesticides that contains water)

<b>DBF Imaging Radar</b>	
Model	RD2418R
Operating Frequency	SRRC (China) / CE (Europe) / FCC (United States): 24.00 - 24.25 GHz MIC (Japan) / KCC (Korea): 24.05 - 24.25 GHz
Power Consumption	15 W
EIRP	SRRC: 13 dBm; MIC / KCC / CE / FCC: 20 dBm
Altitude Detection & Terrain Follow*	Altitude detection range: 1 - 30 m Stabilization working range: 1.5 - 15 m Max slope in Mountain mode: 35°
Obstacle Avoidance System*	Obstacle sensing range: 1.5 - 30 m FOV: Horizontal: $\pm 50^\circ$ , Vertical: 0 - $10^\circ$ Working conditions: Flying higher than 1.5 m over the obstacle at a speed lower than 7 m/s Safety distance: 2.5 m (Distance between the front of propellers and the obstacle after braking) Obstacle avoidance direction: Forward or backward obstacle avoidance depending on the direction of flight.
IP Rating	IP67
<b>FPV Camera</b>	
FOV	Horizontal: $98^\circ$ , Vertical: $78^\circ$
Resolution	1280x960 30 fps
FPV Spotlight	FOV: $110^\circ$ , Max brightness: 12 lux at 5 m of direct light
<b>Flight Parameters</b>	
Operating Frequency	2.4000 - 2.4835 GHz 5.725 - 5.850 GHz**
EIRP (EIRP)	2.4 GHz SRRC / CE / MIC / KCC: < 20 dBm, FCC / NCC: < 26 dBm 5.8 GHz SRRC / NCC / FCC: < 26 dBm
Total Weight (Excluding battery)	19.8 kg
Standard Takeoff Weight	41 kg
Max Takeoff Weight	42 kg (At sea level)
Max Thrust-Weight Ratio	1.975 (Takeoff weight of 41 kg)
Hovering Accuracy (With strong GNSS signal)	D-RTK enabled: Horizontal: $\pm 10$ cm, Vertical: $\pm 10$ cm D-RTK disabled: Horizontal: $\pm 0.6$ m, Vertical: $\pm 0.3$ m (Radar module enabled: $\pm 0.1$ m)
RTK / GNSS Operating Frequency	RTK: GPS L1/L2, GLONASS F1/F2, BeiDou B1/B2, Galileo E1/E5 GNSS: GPS L1, GLONASS F1, Galileo E1
Battery	DJI-approved battery pack (AB2-17500mAh-51.8V)

\* The effective radar range varies depending on the material, position, shape, and other properties of the obstacle.

\*\* To comply with local laws and regulations, this frequency is not available in some countries or regions.

Max Power Consumption	5600 W
Hovering Power Consumption	5200 W (Takeoff weight of 41 kg)
Hovering Time*	18 min (Takeoff weight of 26 kg with a 17500 mAh battery) 10 min (Takeoff weight of 41 kg with a 17500 mAh battery)
Max Tilt Angle	15°
Max Operating Speed	7 m/s
Max Flying Speed	10 m/s (With strong GNSS signal)
Max Wind Resistance	8 m/s
Max Service Ceiling Above Sea Level	2000 m
Recommended Operating Temperature	0° to 40° C (32° to 104° F)
<b>Remote Controller</b>	
Model	GL300N
Operating Frequency	2.4000 - 2.4835 GHz 5.725 - 5.850 GHz**
Effective Transmission Distance (Unobstructed, free of interference)	SRRC / MIC / KCC / CE: 3 km NCC / FCC: 5 km
EIRP (EIRP)	2.4 GHz SRRC / CE / MIC / KCC: < 20 dBm, FCC / NCC: < 26 dBm 5.8 GHz SRRC / NCC / FCC: < 26 dBm
Display	5.5-inch screen, 1920×1080, 1000 cd/m <sup>2</sup> , Android system, 4GB RAM + 16GB ROM storage
Power Consumption	Typical value: 16 W
Operating Temperature	-10° to 40° C (14° to 104° F)
Storage Temperature	Less than 3 months: -20° to 45° C (-4° to 113° F) More than 3 months: 22° to 28° C (70° to 82° F)
Charging Temperature	5° to 40° C (40° to 104° F)
<b>Remote Controller Intelligent Battery</b>	
Model	WB37-4920mAh-7.6V
Battery Type	2S LiPo
Capacity	4920 mAh
Voltage	7.6 V
Energy	37.39 Wh
Charging Temperature	5° to 40° C (40° to 104° F)
<b>Remote Controller Charging Hub</b>	
Model	WCH2
Input Voltage	17.3 - 26.2 V
Output Voltage and Current	8.7 V, 6 A
Operating Temperature	5° to 40° C (40° to 104° F)















\* Hovering time acquired at sea level with wind speeds lower than 3 m/s.

\*\* To comply with local laws and regulations, this frequency is not available in some countries or regions.

### Remote Controller Power Adapter

Model	A14-057N1A
Input Voltage	100-240 V, 50/60 Hz
Output Voltage	17.4 V
Rated Power	57 W

### Aircraft Status Indicators Description

Blinking Patterns	Description
 Blink red, green, and yellow	Self-checking
 ×4 Blink yellow four times	Warming up
 ..... Blink yellow slowly	A-mode (no GNSS)
 ..... Blink green slowly	P-mode (GNSS)
 ..... Blink green rapidly	When an obstacle is detected, the aircraft breaks and hovers to enter obstacle avoidance mode.
 ..... Blink yellow and green alternately	RTK dual antenna is not ready.
 ..... Blink red and green alternately	RTK function is enabled, but RTK positioning is not ready.
 — Solid red	System error. Restart the aircraft, and if still not working, contact DJI Support or a DJI authorized dealer.
 ..... Blink red and yellow alternately	Abnormal compass data. Compass calibration required.
 ..... Blink red rapidly several times	Point A recorded.
 ..... Blink green rapidly several times	Point B recorded.
 ..... Blink yellow rapidly	Remote controller signal lost.
 ..... Blink red slowly	Low battery level.
 ..... Blink red rapidly	Critical low battery level or battery voltage.

### Updating the Firmware

Users can update the firmware of both the aircraft and remote controller in DJI MG2.

1. Power on the remote controller and the aircraft. Make sure that the remote controller has access to the internet via Wi-Fi or a dongle. The firmware file is usually large. It is recommended to use Wi-Fi.
2. Connect the USB-C port on the remote controller to the Micro USB port on the aircraft via a USB-C OTG cable and a Micro USB cable.
3. A prompt appears in the lower right corner of the screen in DJI MG2 when a new firmware update is available. Tap the prompt to enter the firmware screen.
4. Select the desired firmware and tap Update to enter firmware information page.
5. Tap Download XXX (XXX indicates the firmware version) to download the firmware package for all the devices.

6. When the download is complete, tap Update XXX under each device to enter the update page for the corresponding device. Tap Install and wait for the update to complete.
7. After successfully completing the update, restart the remote controller and the aircraft manually.

DJI Assistant 2 for MG can also be used to update the firmware. Refer to [DJI Assistant 2 for MG \(p. 49\)](#) for more information.



DJI Support

<http://www.dji.com/support>

This content is subject to change without prior notice.

Download the latest version from

<http://www.dji.com/t16>

If you have any questions about this document, contact DJI by sending a message to [DocSupport@dji.com](mailto:DocSupport@dji.com).

Copyright © 2020 DJI All Rights Reserved.