



POKÉMON



BUILD & SHOW SQUIRTLE

CRÉER ET MONTRER CARAPUCE

CONSTRUYE Y MUESTRA A SQUIRTLE | CONSTRUA E MOSTRE A SQUIRTLE

GYH00



Build Construisez

Construye | Constrói
Bauen | Стройте



Share Partagez

Comparte | Partilha
Teilen | Делитесь

Device not included | Appareil non inclus
Dispositivo no incluído | Dispositivo não incluído
Gerät nicht enthalten
Устройство не входит в комплект



megaunboxed.com

1



1x

1x

1x

2



1x

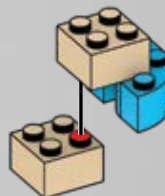

3



1x



1x



1x

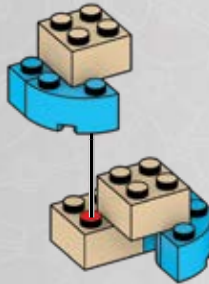
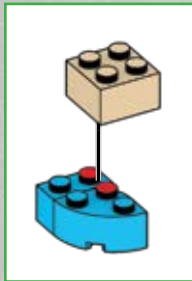

4



2x

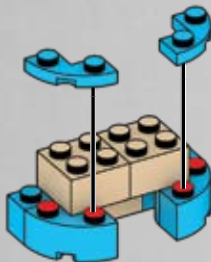

5



1x



1x

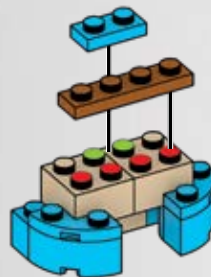

6



1x



1x



7



1x



1x



1

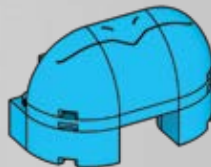

2

8



1x

1x

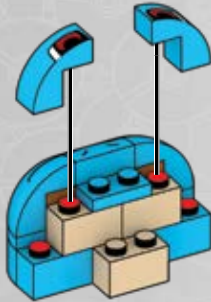

9



1x

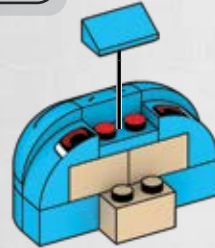

10

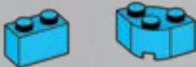

1x

1x

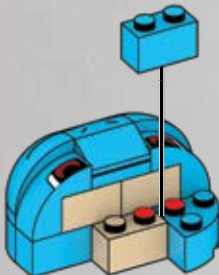

11



1x

1x

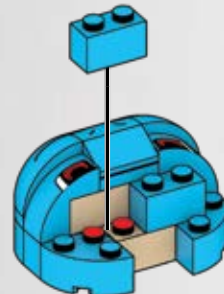

12



1x



1x

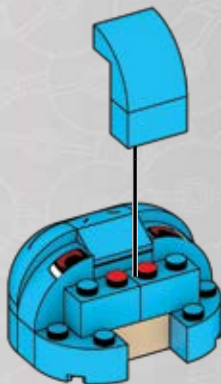
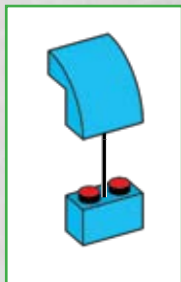

13



1x



1x

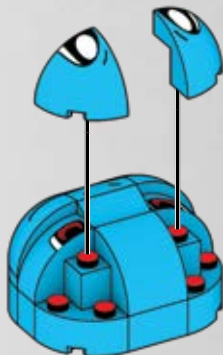

1



2

14



3x



2x



1x

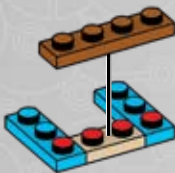

1

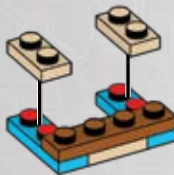

2

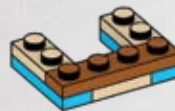

3

15



2x



16



2x



17



1x

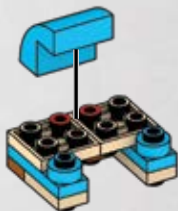

18



1x



1x

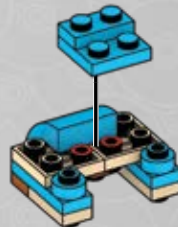
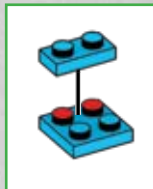

19



2x

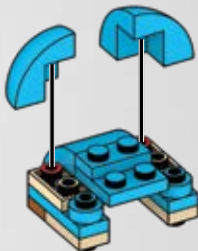

20



2x

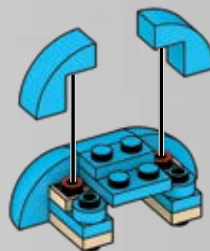

21



2x

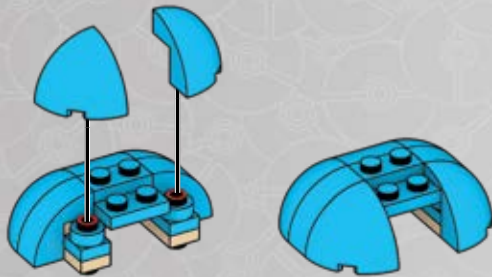

1

2

22



1x

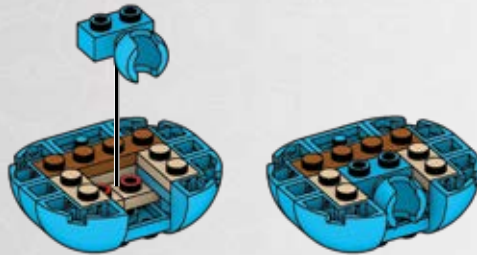

1

2

23

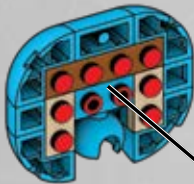

1

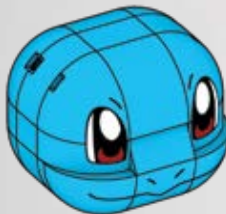

2

24

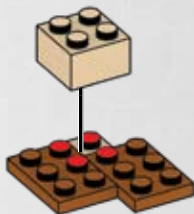
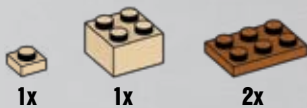

25

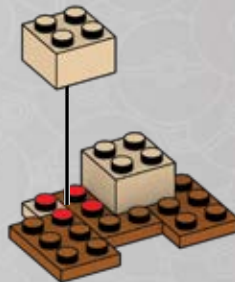

26

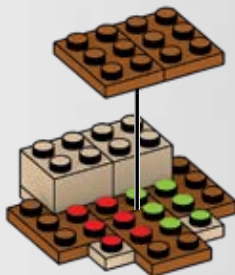

27

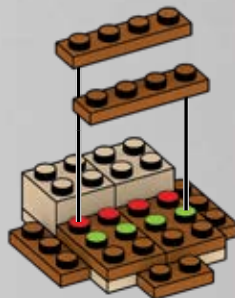

28



2x



1x



29



2x

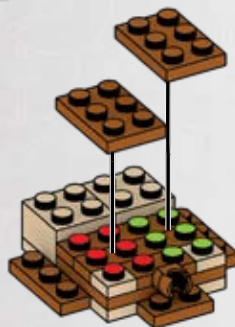

30



1x



1x

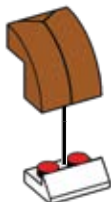

1



2

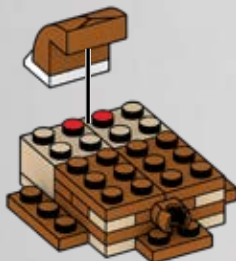

31



2x



2x



1



2

x2

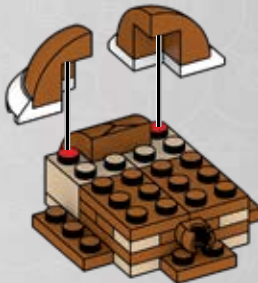

32



1x



1x

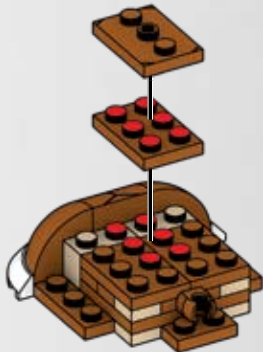

33



1x



34



1x



1x



1x



1x

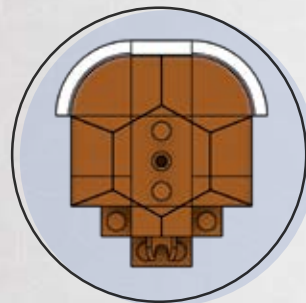

35



2x



2x



1



2

x2

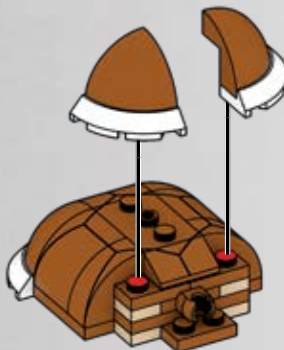

1

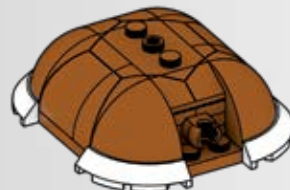

2

36



2x

37



2x



2x



38



2x



2x

39



2x

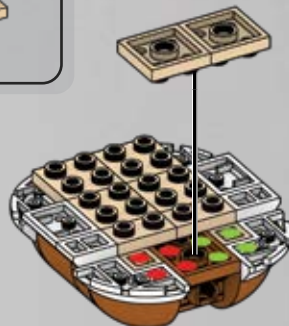

40



1x



2x



1x

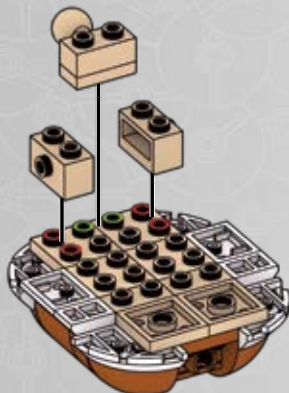
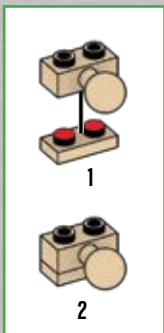

41



4x

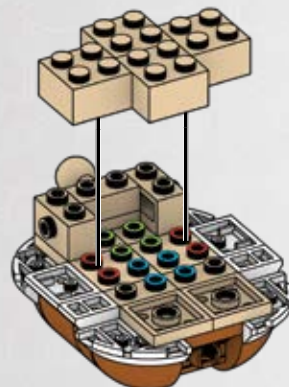

42



2x



2x



4x

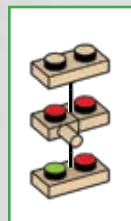
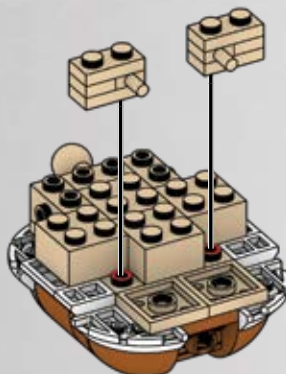
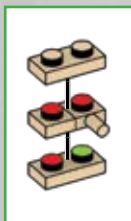

43



2x

1x

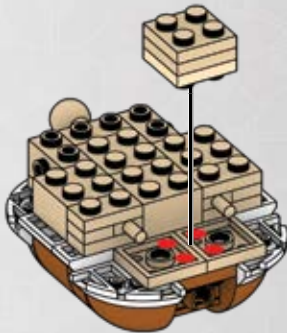
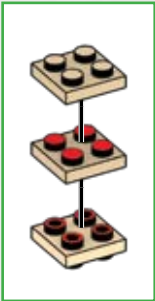

44



2x

2x

1x

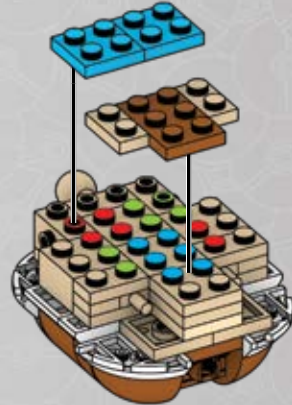

45



1x

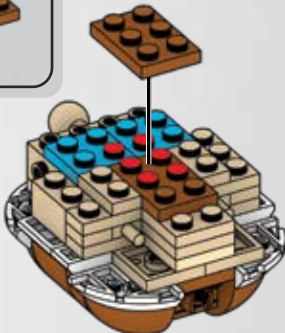

46



2x

2x

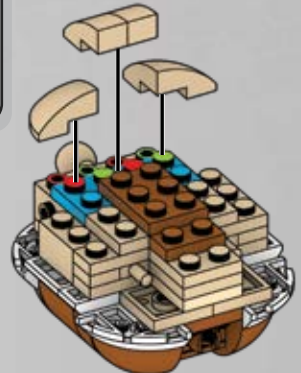

47



1x

1x

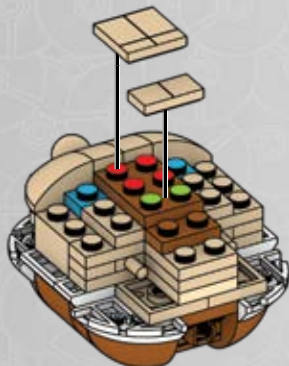

1

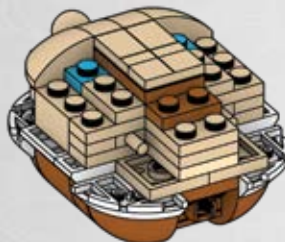

2

48



1x

1x

1x

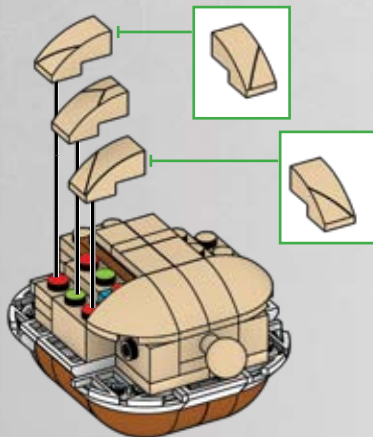

1

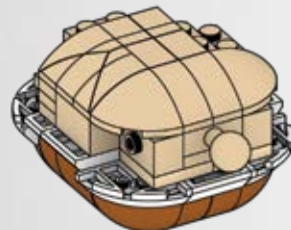

2

49

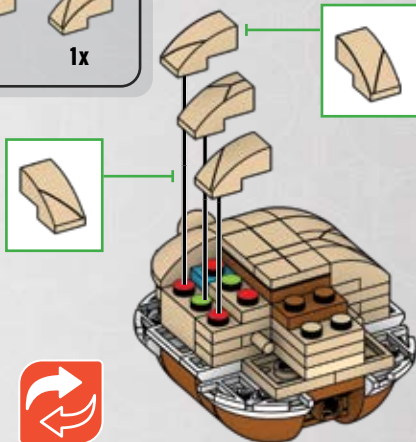
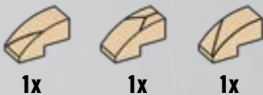

50



2x

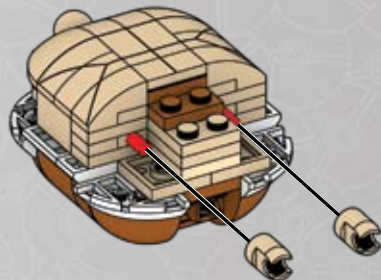

51

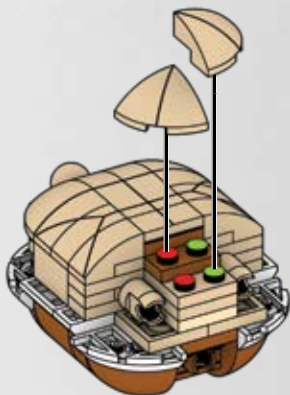

1

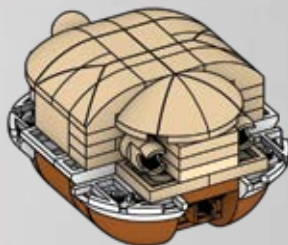

2

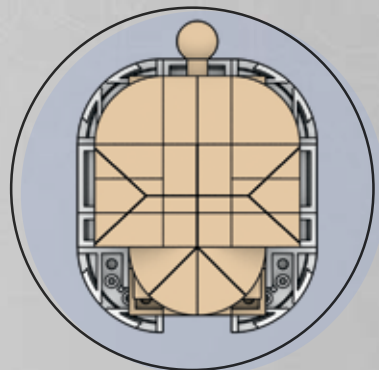

52

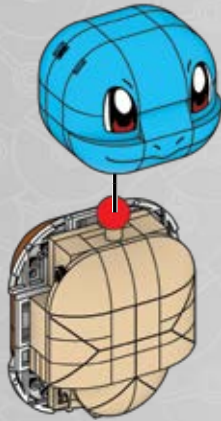

1



2

53



1x

1x

1x

1x



54



1x

1x

1x



1



2

55



56



1



2

57

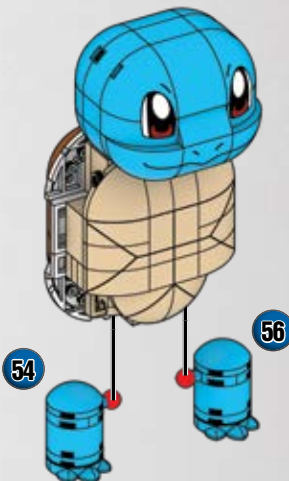

1

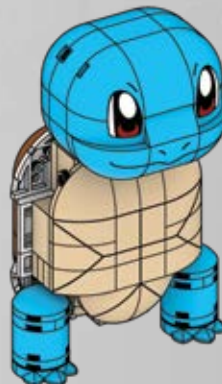

2

x2

58

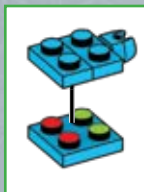

59

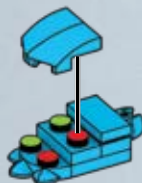

1

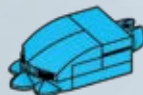

2

60



2x

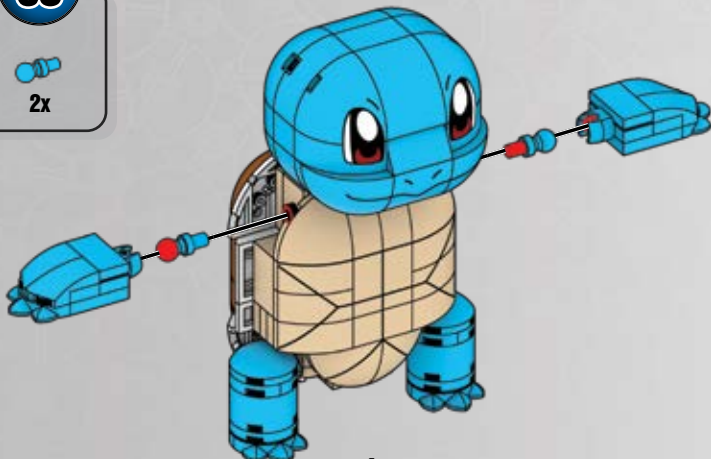

1

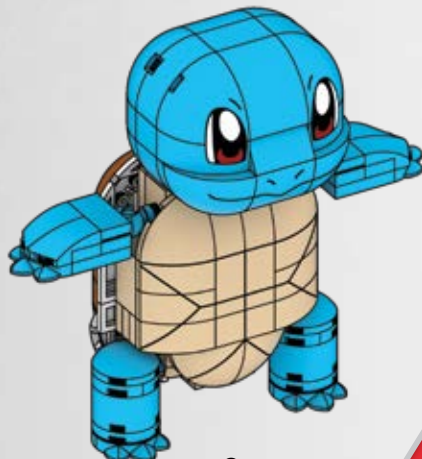

2

61

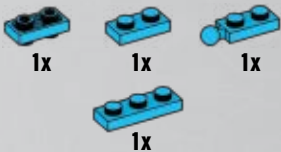

62

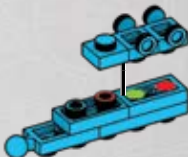

63

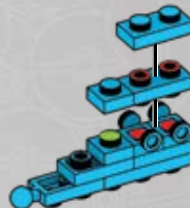

64

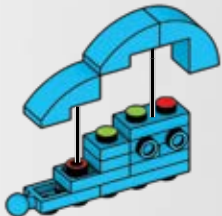

1

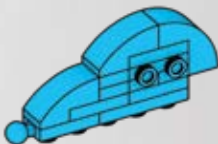

2

65

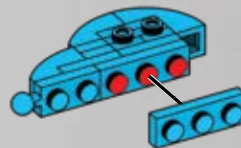

66



1x

1x

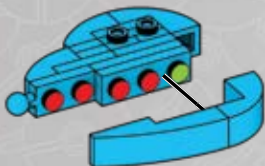

67

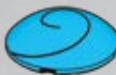

1x

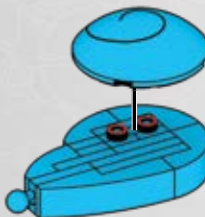

1

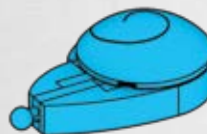

2

68



1x

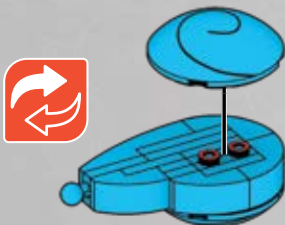

1

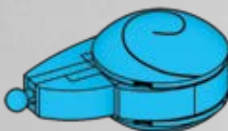

2

69



1x

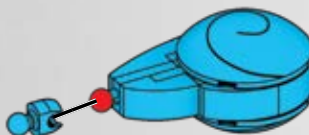

1

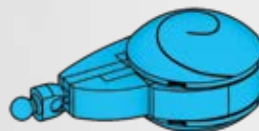

2

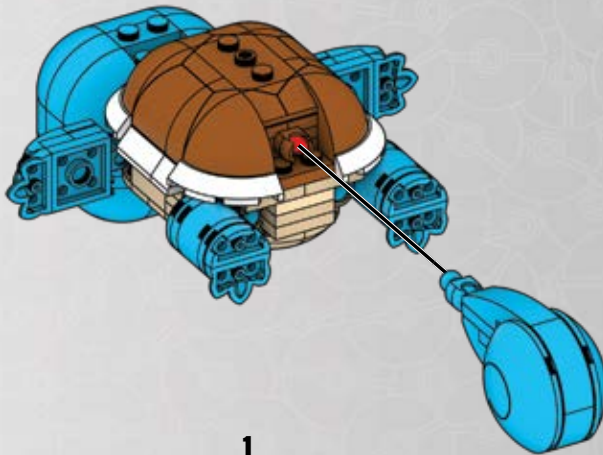

1

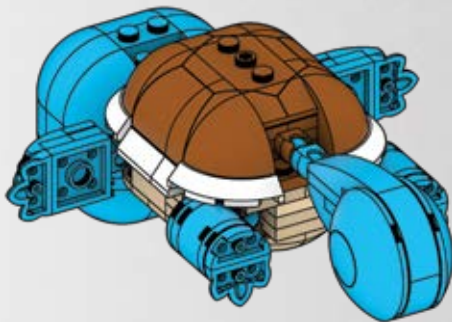

2

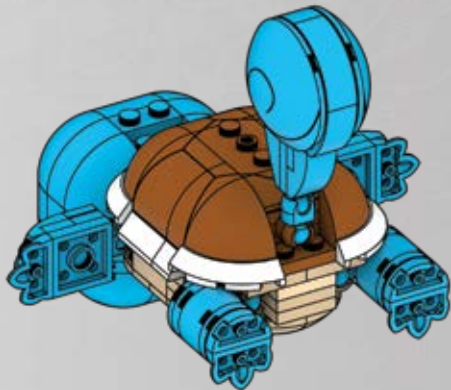

3

71

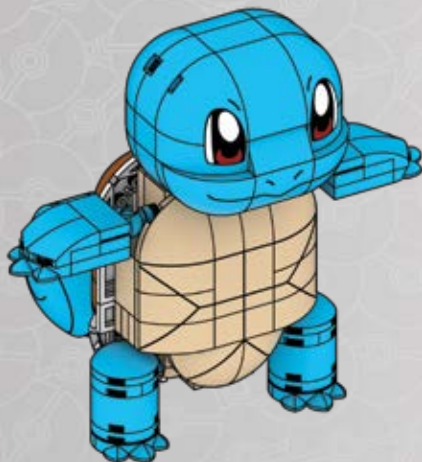

1

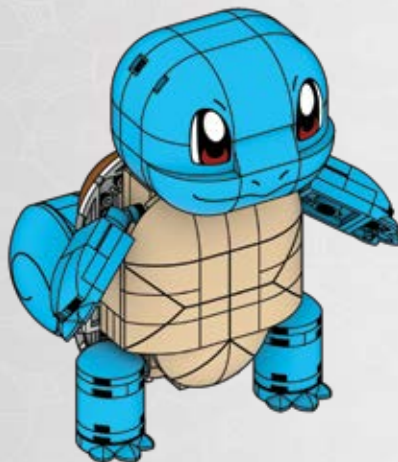

2

72

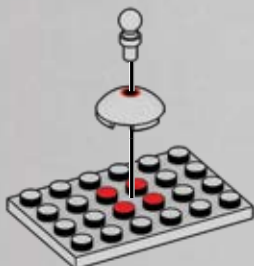

73



1x

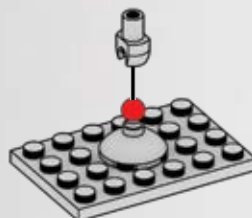

74



1x



1x



1x

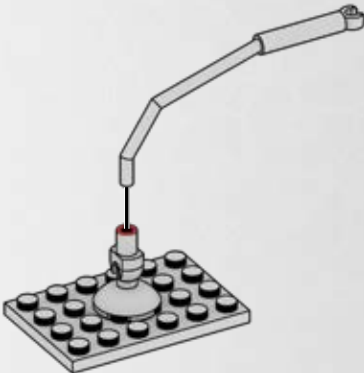
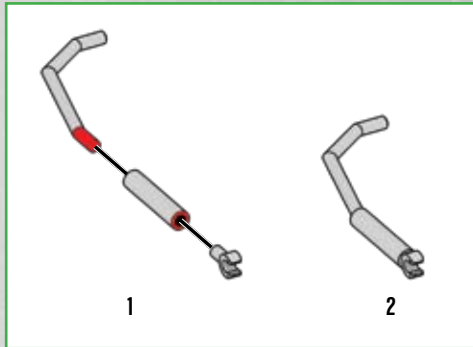

1

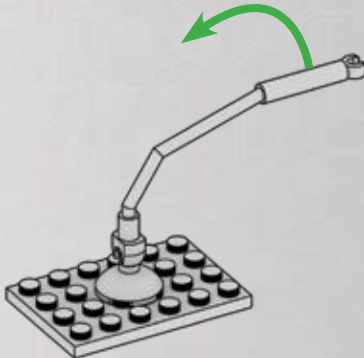

2

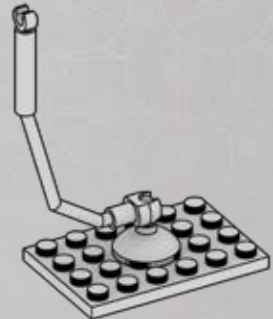

3

75



1x



1x



1x



1x



1x

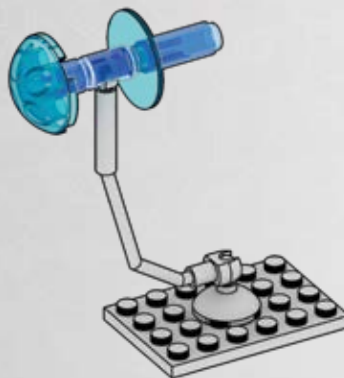
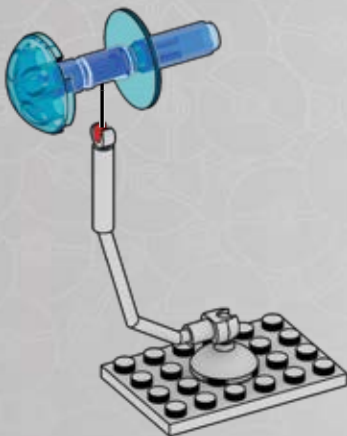
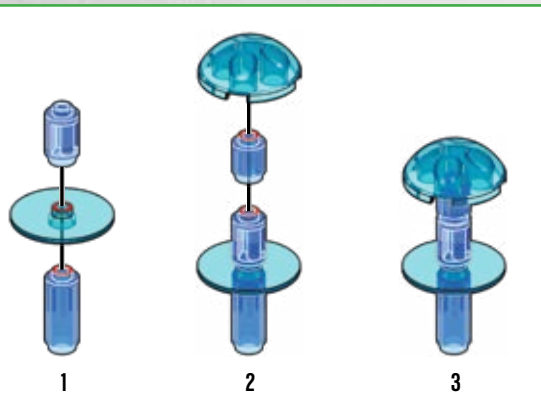

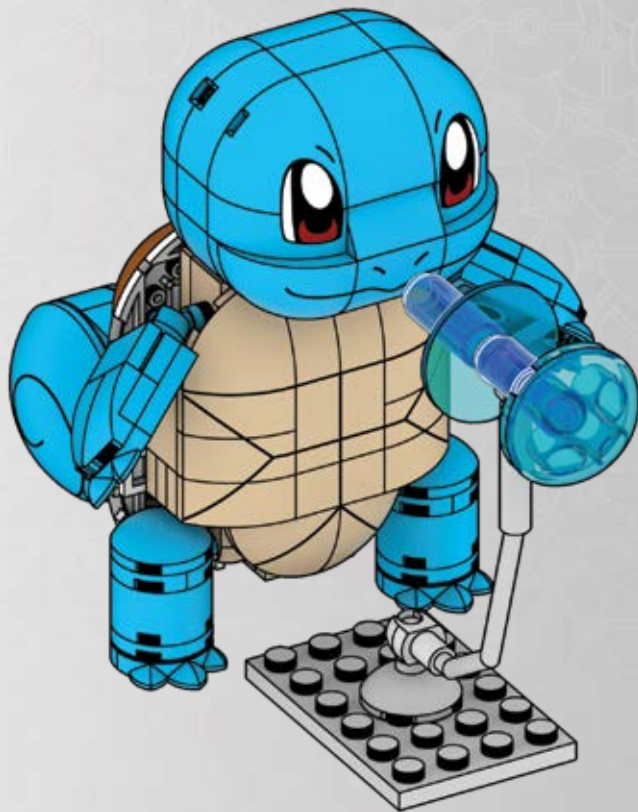



**POSE IT! / VARIEZ LES
POSES ! / ¡PÓSALO!
VOCÊ PODE POSAR!
LÄSST SICH IN COOLE
POSEN BRINGEN!
МЕНЯЙ ПОЗЫ!**



1



2



*Not included / Non inclus / No incluido
não incluido / Nicht enthalten / не входит



1x
AM17062BLG

1x
AM78291BLG

2x
AM78291GD

2x
AM76558GD

2x
AM03328GD

8x
AM03328BTN

2x
AM78273GD

2x
AM01140BTN

1x
AM78289GD

2x
AM19530E

2x
AM78275BTN

1x
AM80144HJ

1x
AM76776HJ

1x
AM09129HJ

1x
AM80485BLG

4x
AM78392GD

4x
AM79375GD

2x
AM80011GD

2x
AM022501GD

1x
AS-GYH00-08

10x
AM09393BTN

7x
AM09393GD

2x
AM16680GD

2x
AM16680BTN

2x
AM78277GD

1x
AM78277ANM

1x
AM78276GD

2x
AM04322GD

2x
AM74427GD

2x
AM74426GD

2x
AM78285GD

1x
AM79679BLG

2x
AM74677GD

1x
AM79018GD

1x
AM18549GD

1x
AS-GYH00-17

3x
AM09835E

2x
AM01320GD

5x
AM09013GD

2x
AM18601BTN

1x
AM79796GD

1x
AM79227BTN

2x
AM17788GD

2x
AM17788BTN

1x
AS-GYH00-09

1x
AS-GYH00-10

1x
AS-GYH00-12

2x
AS-GYH00-11

1x
AS-GYH00-13

4x
AM16682GD

1x
AS-GYH00-21

1x
AS-GYH00-19

1x
AS-GYH00-02

1x
AS-GYH00-04

4x
AM02212GD

1x
AS-GYH00-07

1x
AM79017FM

5x
AM03773GD

4x
AM03773BTN

7x
AM01146BTN

9x
AM09023BTN

1x
AM72233BLG

4x
AM81207E

2x
AM80799BTN

2x
AS-GYH00-14

2x
AM08481GD

1x
AS-GYH00-15

1x
AS-GYH00-18

1x
AS-GYH00-20

1x
AS-GYH00-22

4x
AM80634ANM

4x
AM80634GD

4x
AM80634GD

1x
AS-GYH00-01

1x
AS-GYH00-03

1x
AS-GYH00-23

1x
AS-GYH00-24

1x
AS-GYH00-25

1x
AM78287ANJ

1x
AM80832ANJ

4x
AM01314GD

11x
AM03772ANM

1x
AS-GYH00-16

4x
AM09593ANM



1x
AM19323GD



1x
AS-GYH00-05



1x
AS-GYH00-06



1x
AM77190BLG



1x
AM17055BLG

Missing pieces? Pièces manquantes?

¿Partes faltantes? • Perdeu peças?
Fehlern Teile? • Не хватает деталей?

support.megabrand.com

Build & Show Squirtle / Créer et montrer Carapuce / Construye y muestra a Squirtle / Construa e Mostre o Squirtle / Costruisci e mostra Squirtle /
Bauen & Zeigen Schiggy / Buduj i pokaz Squirtle / Bouw en laat Squirtle zien / Построй и покажи Squirtle / Κατασκευή & Εμφάνιση Squirtle /
Squirtle'ı Birleştire ve Göster / Squirtle építés és megjelentése / Bygg och visa Squirtle / Rakenna & näytä Squirtle / Byg og vis Squirtle / Bygg & Vis
Squirtle / Sestavte a predvedte Squirtle / Vytvorte a ukáže Squirtle / وعرض سكويرتل

Mattel Europa B.V., Gonderl 1, 1186 MJ Amstelveen, Nederland. Mattel U.K. Limited, The Porter Building, 1 Brunel Way, Slough SL1 1FQ, UK. Mattel France, Parc de la Cerisaie, 1/3/5 allée des Fleurs, 94260 Fresnes Cedex. N° Cristal 0969 36 99 99 (Numéro non surtaxé) ou www.lesjouetsmattel.fr Mattel Belgium, Trade Mart, Atomiumsquare, Bogota 202 – B 275, 1020 Brussels. Gratis nummer België: 0800 – 16 936 - Gratis nummer Luxembourg: 800 - 22 784 - Gratis nummer Nederland: 0800 - 262 88 35. Deutschland : Mattel GmbH, Solmsstraße 4, D-60486 Frankfurt am Main. Schweiz: Mattel AG, Kirchstrasse 24, CH-3097 Liebefeld. Österreich: Mattel Ges.m.b.H., Campus 21, Liebermannstraße A01 404, A- 2345 Brunn/Gebirge. Mattel Italy Srl, Via Bracco, 6-MAC 6, 20159 Milano, Italy. Servizio assistenza clienti: Customers.rv.italia@mattel.com - Numero verde 800 11 37 11. Mattel España, S.A., Aribau 200. 08036 Barcelona. cservice.spain@mattel.com Tel: 900 102 390 http://www.service.mattel.com/es. Mattel East Asia Ltd., Room 503-09, North Tower, World Finance Centre, Harbour City, Tsimshatsui, HK, China. Tel.: (852) 3185-6500. Diimport & Diedarkan Oleh: Mattel Continental Asia Sdn Bhd. Level 19, Tower 3, Avenue 7, No. 8 Jalan Kerinchi, Bangsar South, 59200 Kuala Lumpur, Malaysia. Mattel South Africa (PTY) LTD, Office 102 13, 30 Melrose Boulevard, Johannesburg 2196. Dystrybutor: Mattel Poland Sp. z o.o., Warsaw Trade Tower 34 p., ul. Chłodna 51, 00-867 Warszawa. Mattel Australia Pty. Ltd., 658 Church St., Richmond, Victoria, 3121. Consumer Advisory Service - 1300 135 312. Mattel AEBE, Εθνάρχου Μακαρίου 1, Κτήριο Κ-2, ΤΚ 17561, Παλαιό Φάληρο. Mattel Oyuncakçılık Tic. Ltd. Şti. İçerenköy Mah., Erku Sok. A Blok No:12 Üner Plaza Kat:9-10 34752 Ataşehir İstanbul. Tel: 0216 570 75 00. Импортер/Уполномоченная организация: ООО "МАТТЕЛ" Российская Федерация, 105120 Москва, 2-й Сыромятинский переулок, 1; +7 495 287 79 39. Mattel Czech Republic s.r.o., The Forum, Václavské nám. 19, 11000 Praha 1. Mattel, 333 Continental Boulevard, El Segundo, CA 90245, USA. Consumer Services: 1-800-465-MEGA (6342). Mattel Canada Inc., Mississauga, Ontario L5R 3W2. Consumer Services: You may call us free at / Composez sans frais le 1-800-524-8697. Importado y distribuido por Mattel de México, S.A. de C.V., Miguel de Cervantes Saavedra No. 193, Pisos 10 y 11, Col. Granada, Alcaldía Miguel Hidalgo, C.P. 11520, México, Ciudad de México. R.F.C. MME-920701-NB3. Tels.: 59-05-51-00 Ext. 5206 ó 01-800-463-59-89. Mattel Chile, S.A., Avenida Américo Vespucio 501-B, Quilicura, Santiago, Tel.: 1230-020-6213. Servicio al consumidor Venezuela: Tel.: 0-800-100-9123. Mattel Argentina, S.A., Av. Libertador 1000, Piso 11 – Oficinas 109 y 111, Vicente López – Prov. Buenos Aires. Tel.: 0800-666-3373. Mattel Colombia, S.A., Calle 123#7-07 P5, Bogotá. Tel.: 01800-710-2069. Mattel Perú, S.A., Av. Juan de Arona # 151, Centro Empresarial Juan de Arona, Torre C, Piso 7, Oficina 704, San Isidro, Lima 27, Perú. RUC: 20425853865. Reg. Importador: 02350-12-JUE-DIGESA. Tel.: 0800-54744. E-mail Latinoamérica: servicio.clientes@mattel.com. Mattel do Brasil Ltda. - CNPJ: 54.558.002/0001-20 - Rua Verbo Divino, 1488 - 2º - Andar - 04719-904 - Chácara Santo Antônio - São Paulo - SP - Brasil. Serviço de Atendimento ao Consumidor: fone 0800 575 0780. E-mail: sac.matteldobrazil@mattel.com

ATTENTION : DANGER
D'ÉTOUFFEMENT. - PRÉSENCE DE PETITS
ÉLÉMENTS. NE CONVIENT PAS AUX ENFANTS DE
MOINS DE 3 ANS.

ATENÇÃO! NÃO INDICADO / NÃO
RECOMENDÁVEL PARA CRIANÇAS MENORES DE 3
(TRÊS) ANOS POR CONTER PARTE(S) PEQUENA(S)
QUE PODE(M) SER ENGOLIDA(S) OU ASPIRADA(S)
PODENDO PROVOCAR ASFIXIA.

警告:
のどにつまる危険 小さな部品が含まれています
3歳以下の子供には与えないで下さい。

警告!
不适合3岁以下儿童使
用。内含小零件。

⚠ **WARNING : CHOKING HAZARD.** - Small parts.

Not for children under 3 years.

ADVERTENCIA: PELIGRO DE ATRAGANTAMIENTO. Juguete no recomendado
para menores de 3 años, porque contiene piezas pequeñas que podrían
provocar asfixia en caso de ser ingeridas o inhaladas por el/la niño/a.

AVVERTENZA: Contiene pezzi di piccole dimensioni.

ACHTUNG: Kleine Teile.

OSTRZEŻENIE: Małe części. Niebezpieczeństwo zadławienia.

WAARSCHUWING: Kleine onderdelen

ПРЕДУПРЕЖДЕНИЕ: Мелкие детали.

ADVARSEL: Indeholder små dele.

WARNING: Små delar

ADVARSEL: Små deler

VAROITUS: Pieniä osia

ΠΡΟΣΟΧΗ: Περιλαμβάνονται μικρά κομμάτια.

UYARI: Küçük parçalar.

UPOZORNĚNÍ: Malé díly

UPOZORNENIE: Malé časti

FİGELMEZTÉTÉS: Kis alkatrészek.



0-3

©2022 Pokémon. ©1995–2022 Nintendo /
Creatures Inc. / GAME FREAK inc.
TM, ®, and character names are trade-
marks of Nintendo.

©2022 Pokémon. ©1995–2022 Nintendo/
Creatures Inc. / GAME FREAK inc.
TM, ® and the noms des personnages sont
des marques de Nintendo.

Ⓟ **D835,727, D834,105**

تحذير:

غير مناسبة للأطفال دون 36 شهراً - قطع صغيرة.

MEGA™

POKÉMON™



HDL84



GMD31



GVK83



Set(s) sold separately and subject to availability. / Ensemble(s) vendu(s) séparément. Certains produits peuvent ne pas être commercialisés. / Se vende(n) por separado y está(n) sujeto(s) a disponibilidad. / Conjunto(s) vendido(s) em separado e sujeito(s) à disponibilidade. / Set in vendita separatamente, secondo disponibilità. / Das/Die Set(s) sind separat erhältlich. / Zestawy/ sprzedawany(e) oddzielnie w zależności od dostępności. / Set(s) apart verkrijgbaar en afhankelijk van beschikbaarheid. / Набор(-ы) продаются отдельно, при наличии. / Sæt sælges separat og så længe lager haves. / Seten säljs separat så länge lagret räcker. / Settet/settene selges separat så langt lageret rekker. / Pakkaus/pakkausset myydään erikseen, saatavuus voi vaihdella. / Το(α) σετ πωλούνται ξεχωριστά και ανάλογα με τη διαθεσιμότητα. / Setler ayrı olarak satılır ve stoklarla sınırlıdır. / Set (sety) se prodává (prodávaji) samostatně dle aktuální nabídky. / Súprava/-y sa predáva(jú) samostatne a podľa dostupnosti. / A készlet(ek) külön kapható(k), az elérhetőség változhat. /

セット商品は別売りになります。在庫状況は別途ご確認をお願いします。 /
تُباع المجموعة أو المجموعات على حدة وتخضع لتوافرها.

每套单独发售，按供货情况决定。

Mattel Canada Inc. Mississauga, Ontario L5R 3W2.
MADE IN CHINA. FABRIQUÉ EN CHINE. FABRICADO NA / HECHO EN CHINA.
ИЗГОТОВЛЕНО В КИТАЕ. ÇIN'DE ÜRETİLMİŞTİR. صنع في الصين

©2022 MEGA Brands &™ MEGA Brands.
Printed in China / Imprimé en Chine

AD-GYH00-02

UK
CA



1186 MJ, 1, NL