

MEGATM

POKÉMONTM



HTJ03

**TOWN SCENE
SCÈNE DE VILLE**

PAISAJE URBANO / CENA DA CIDADE
STADTABENTUEUR / ГОРОД



**GET INSTRUCTIONS ONLINE
INSTRUCCIONES DISPONIBLES
EN LIGNE**

CONSULTA LAS INSTRUCCIONES EN LÍNEA
OBTEN INSTRUÇÕES ONLINE
ANWEISUNGEN ONLINE ERHÄLTICH
ИНСТРУКЦИИ ДОСТУПНЫ ОНЛАЙН



megaunboxed.com



1



3x



1x



2x



1x



1



2

x2

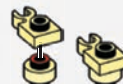
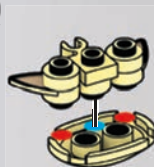

1



2

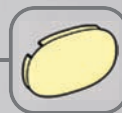

2



1x

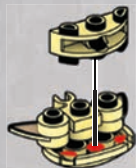

3



1x



1x



1



2

4



1x



1



2

5



2x



1x



1x



6



1x

7



2x



1



2



8



2x



2x

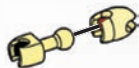

1



2

x2

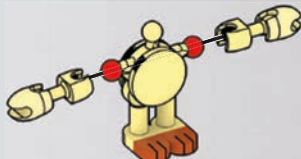

1



2

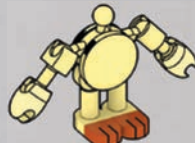

3

9

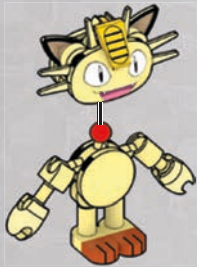

1



2

10



2x



1x



1x



1x



1x

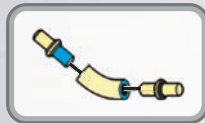

1



2

11



1



2



3



12



1x



2x

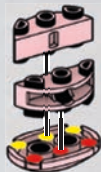

13



1x



1x



1



2

14



1x



1x



1



2

15



16



1

2

17



18

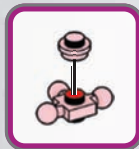

19



2x

1x



20



1x



1

2

21



22



2x

2x

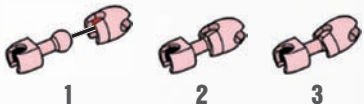

1

2

3

x2



1



2



24

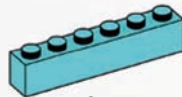

2x

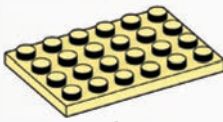

1x

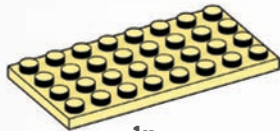

1x

23



1x

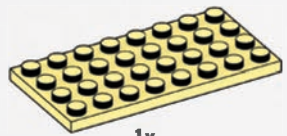

1x

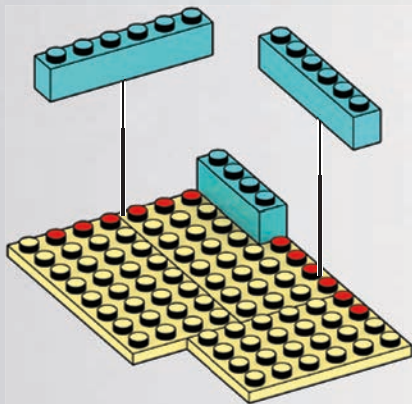
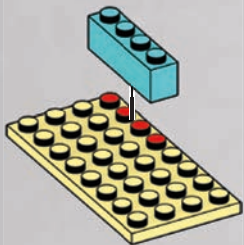

25



26

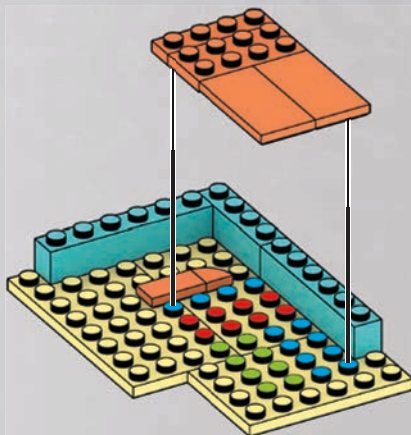
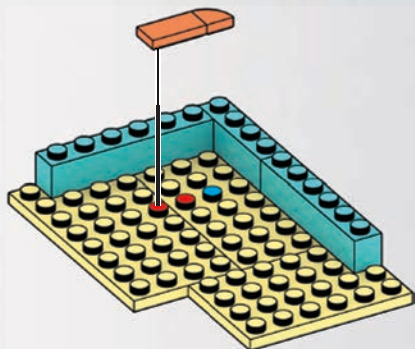
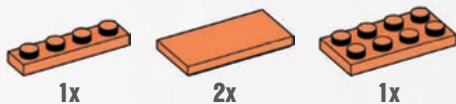

27



1x



1x

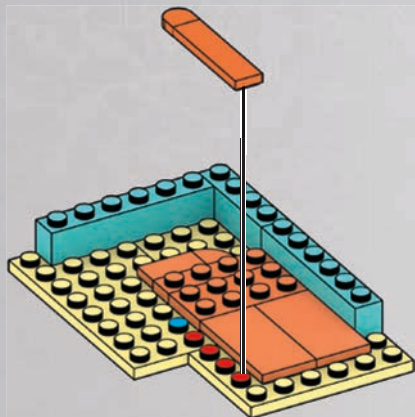

28



1x



1x

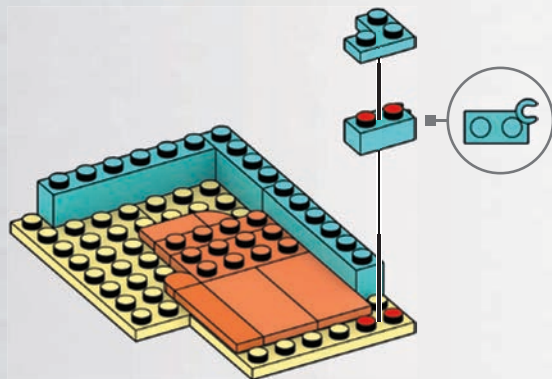

29

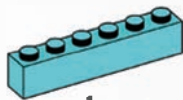

1x



1x

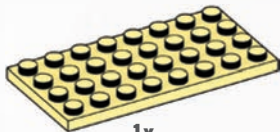

1x

30



1x



1x

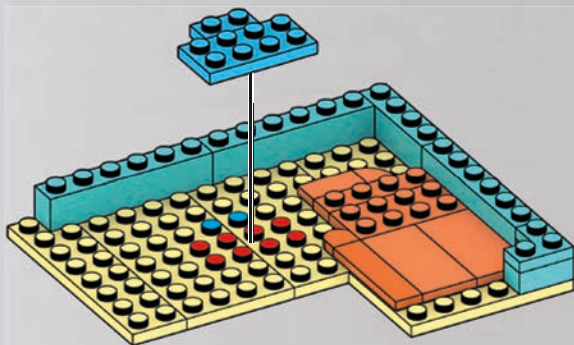
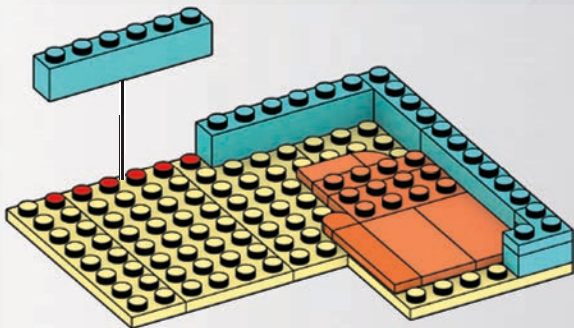

31

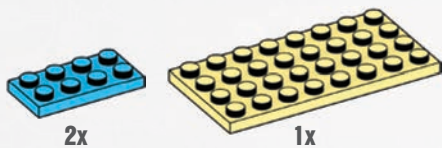

32

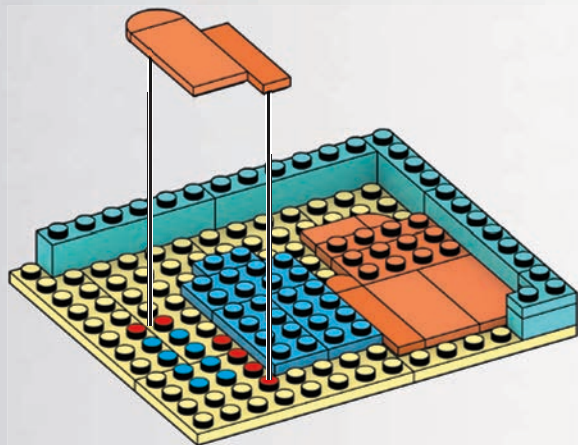
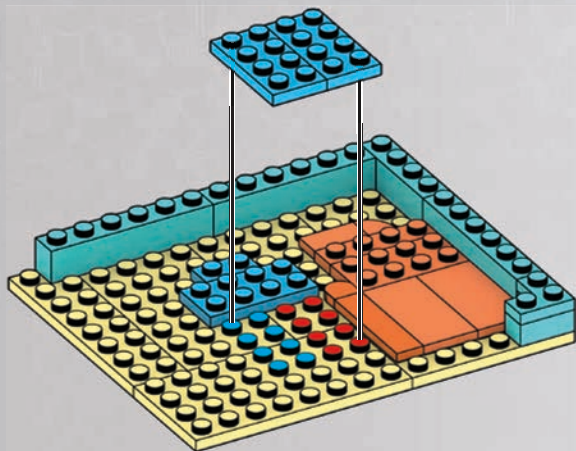
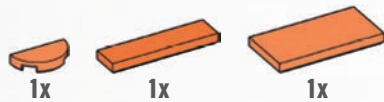

33



1x



1x

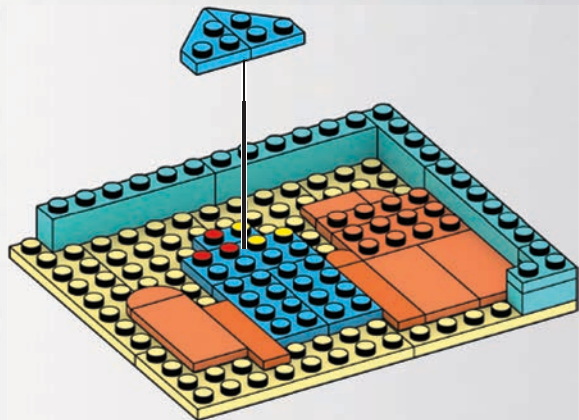

34



2x



1x

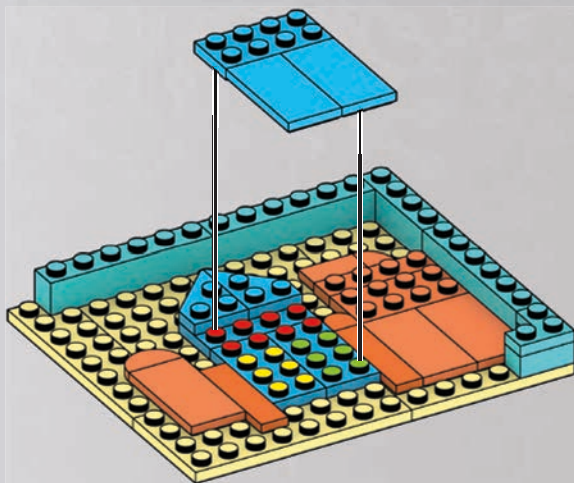

35

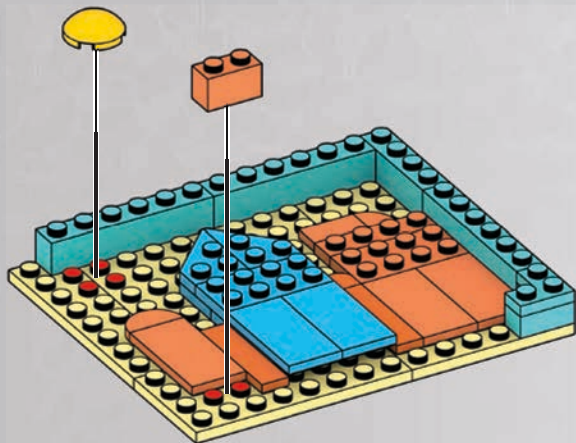

36

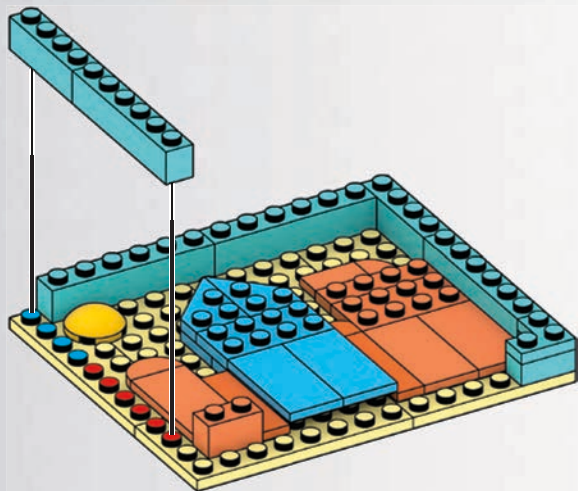
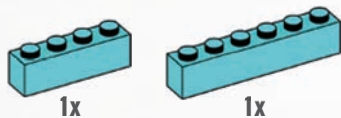

37



1x



1x

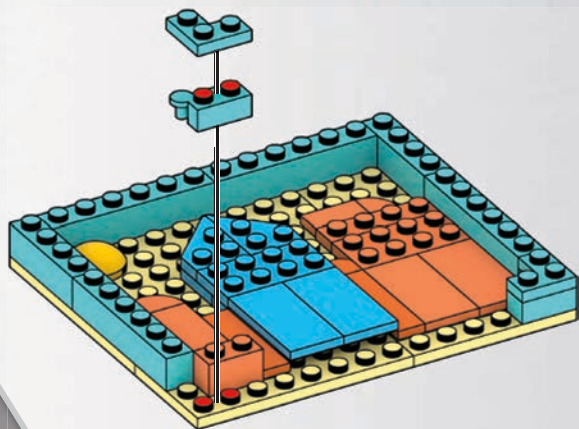

38



1x



2x

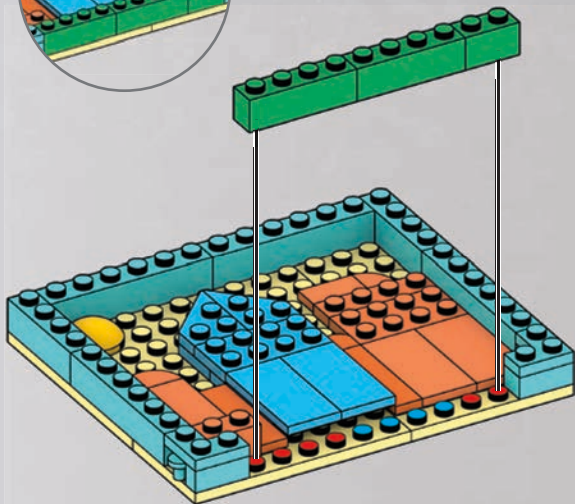
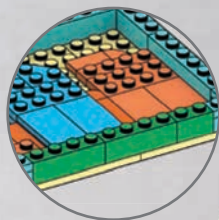

39



1x

40



1x



3x

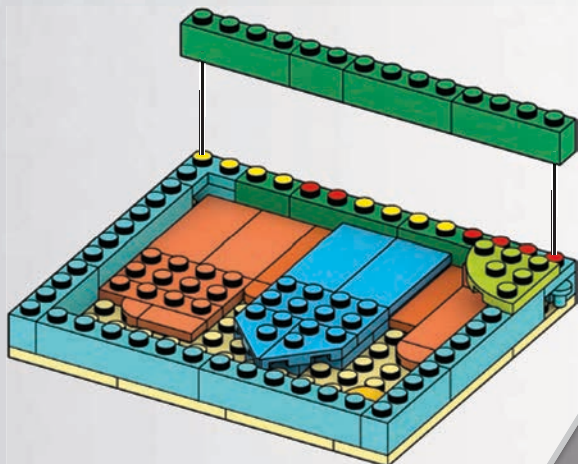
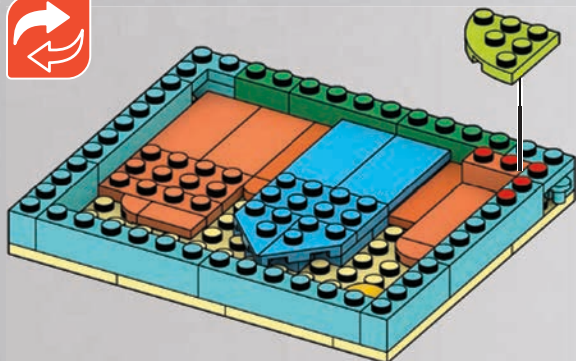

41



1x



2x

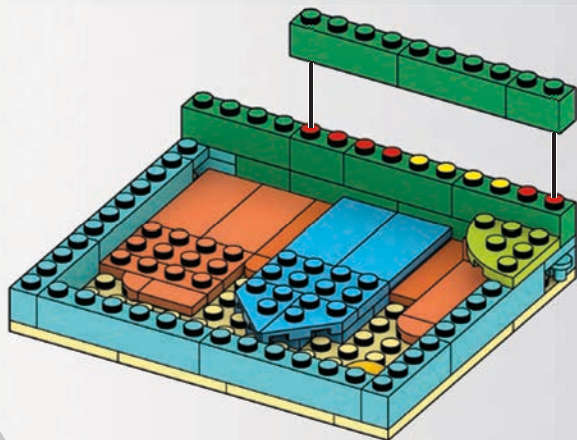

42



1x



1x

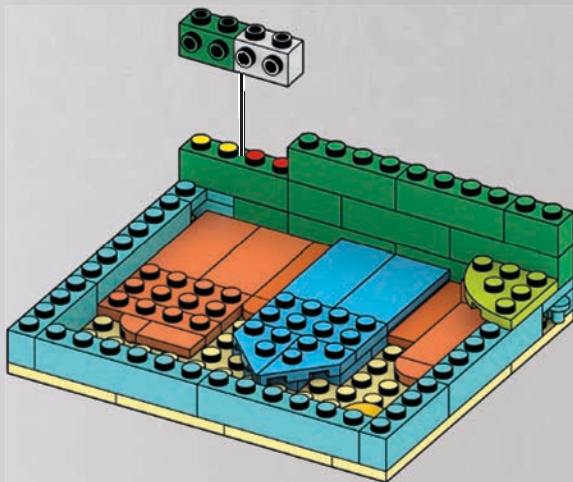

43



1x



1x



2x

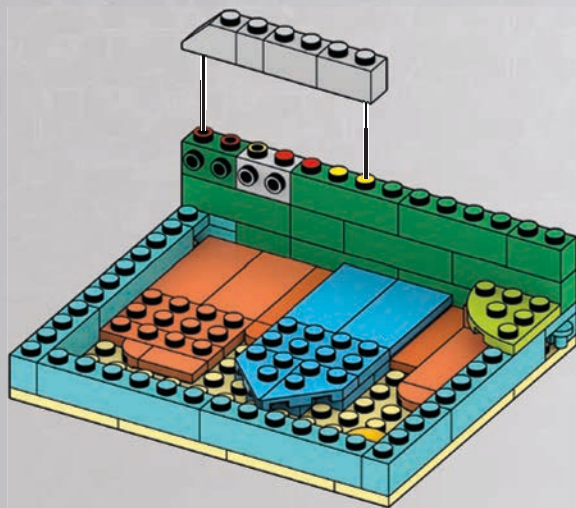

44



2x



1x



1x

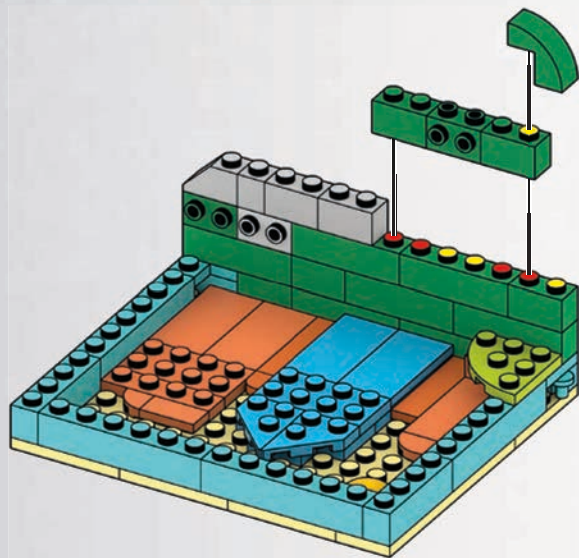

45



3x



1x

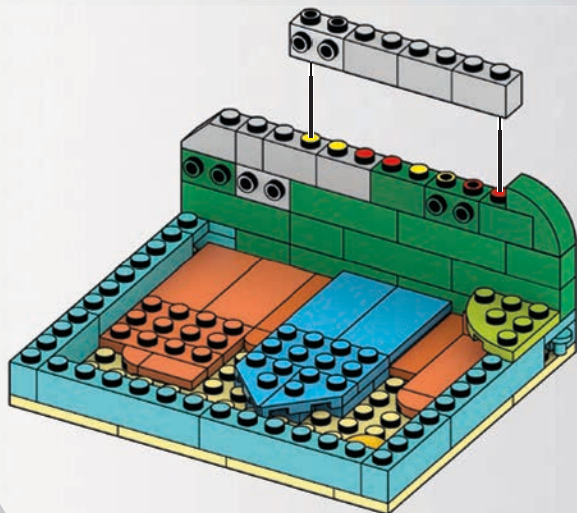

46



2x



2x



1



2

x2

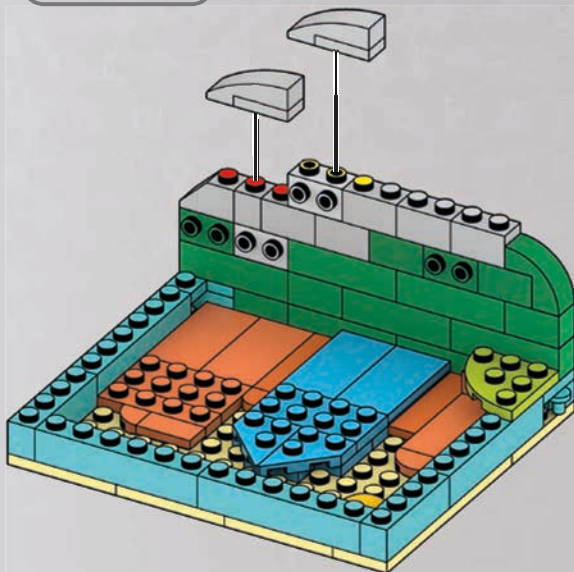

47



1x



1x



1x

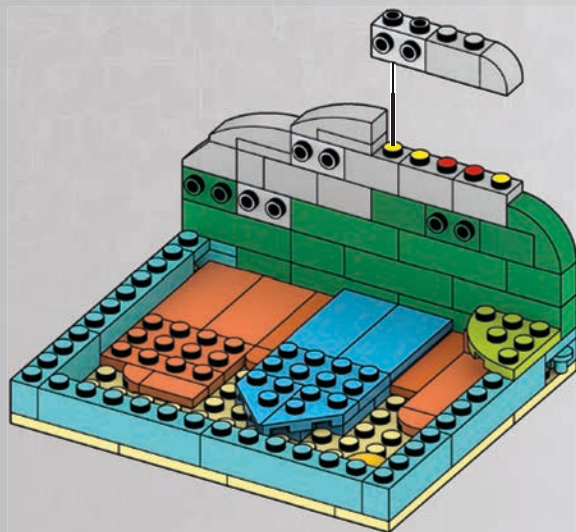

48



2x



1x

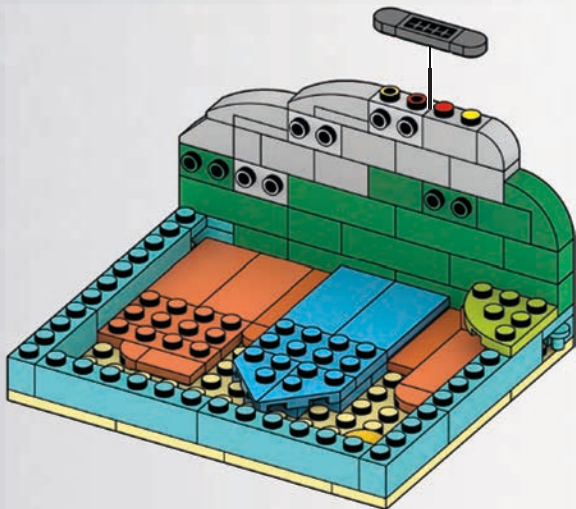

49

1x

1x

1x



1

2

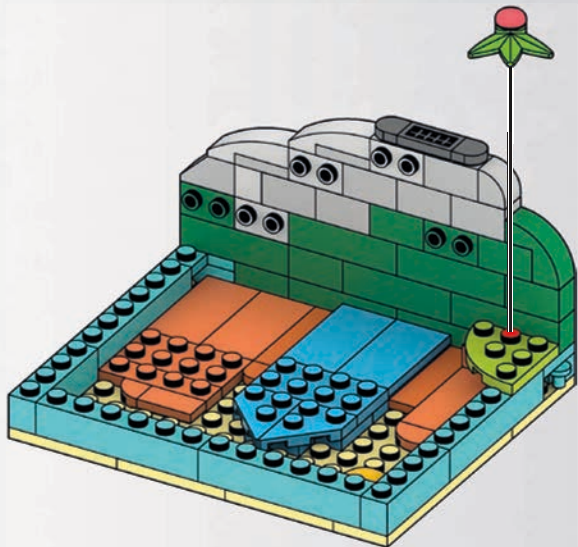

1

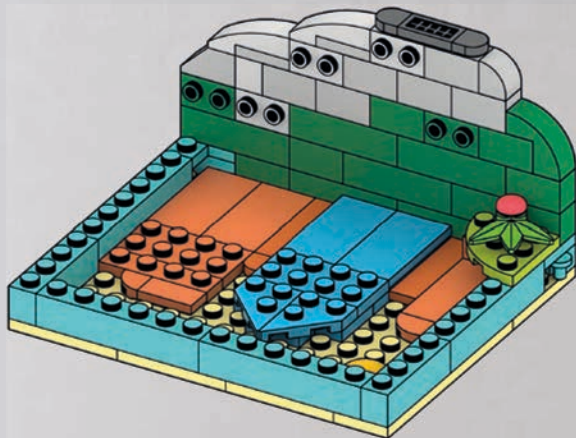

2

50

1x



1x



1



2

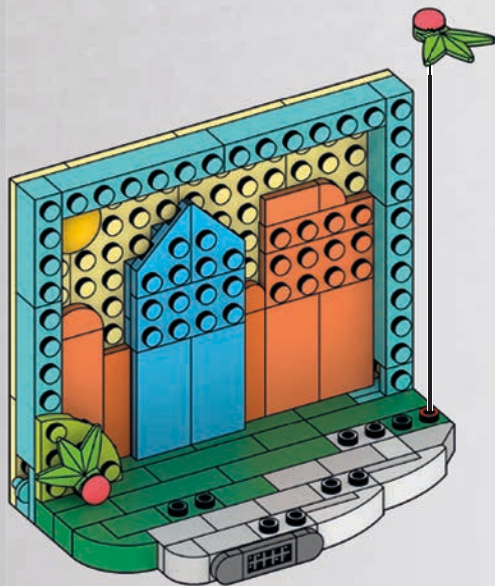

51



1x



1x



1x



1x



1x



1x



1



2



3



4

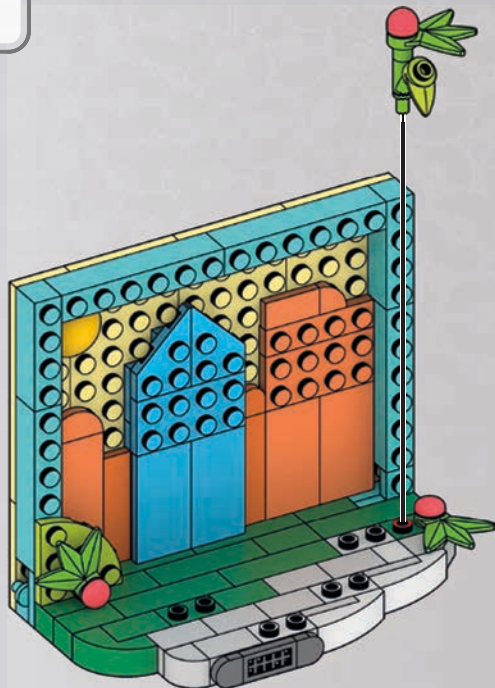

52



1x



1x

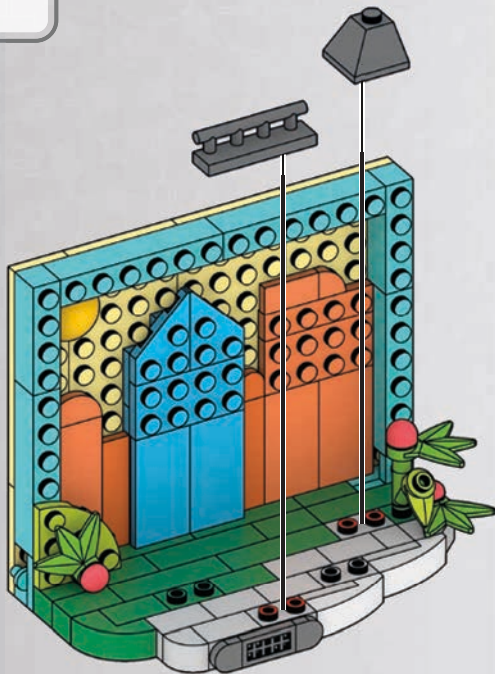

53



1x



1x



1x

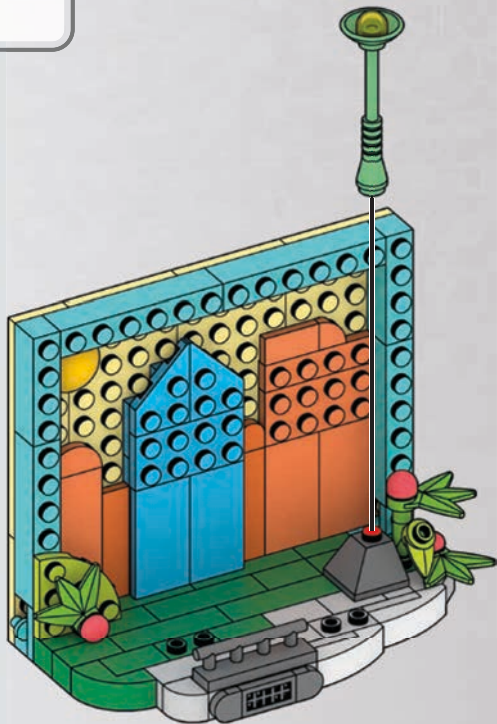
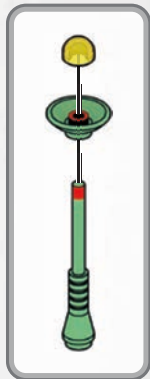

54

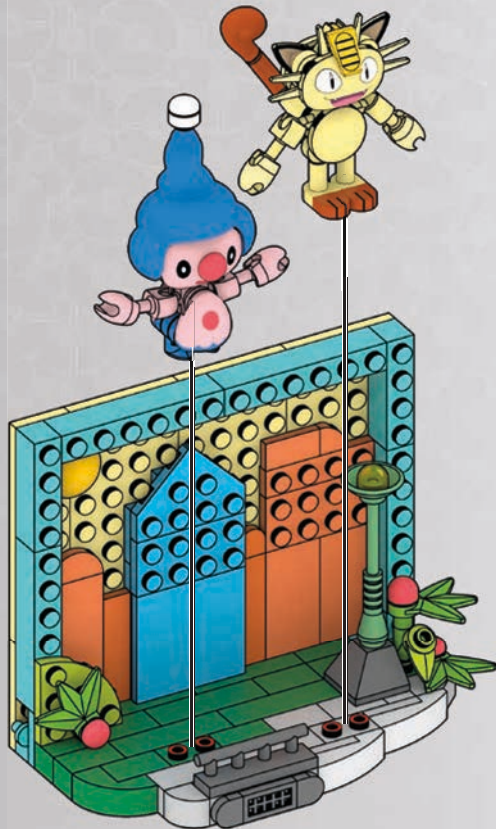

1

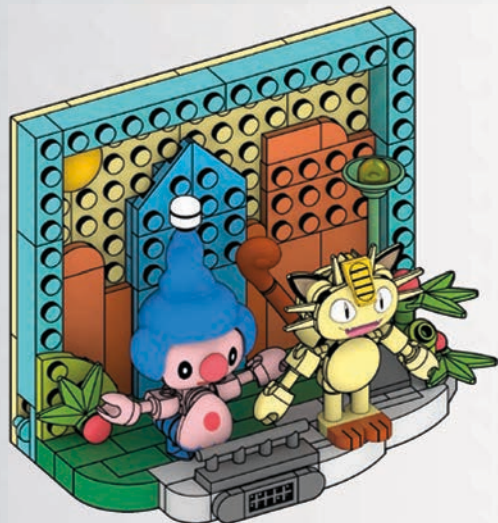

2

1x 
 AM75332E

3x 
 AM75332RQ

2x 
 AM01113NU

1x 
 AM01113JS

1x 
 AM78219ZD

1x 
 AM78219RQ

3x 
 AM76558CS

1x 
 AM76558E

1x 
 AM81716AAD

2x 
 AM76204BDG

1x 
 AM76204BOR

1x 
 AM74397JS

1x 
 AM17003JS

2x 
 AM17003CS

1x 
 AM17003PH

1x 
 AM78291HP

2x 
 AM80010CS

1x 
 AM18591CS

1x 
 AM81193BBG

2x 
 AM80174HP

2x 
 AM79977CS

2x 
 AM79977NU

1x 
 AM79403PH

1x 
 AM79403CS

2x 
 AM79981HP

2x 
 AM78290CS

2x 
 AM78290NU

2x 
 AS-FVR55-03

1x 
 AM07659BLG

1x 
 AM01086BLG

1x 
 AS-DYF08-02

2x 
 AS-GFC90-02

1x 
 AM79288AAD

1x 
 AM18756BDG

1x 
 AM22501AAD

2x 
 AM09393BLG

1x 
 AM09393GD

1x 
 AM79278JS

1x 
 AM74016AXT

1x 
 AM79982CS

1x 
 AM78285BYE

1x 
 AM78285CS

1x 
 AM01322BLG

1x 
 AM76559ASU

1x 
 AM76560ASU

5x 
 AM09013BMG

1x 
 AM09013AAD

6x 
 AM09013BLG

3x 
 AM17502BLG

2x 
 AM17502BMG

1x 
 AM81418NU

1x 
 AM79978CS

1x 
 AM78282CS

2x 
 AM78282NU

1x 
 AM80560PH

2x 
 AM15484ASU

1x 
 AM76206GD

1x 
 AM76205GD

3x 
 AM78382JS

1x 
 AM16682BMG

1x 
 AM16641BDG

2x 
 AM07230BLG

1x 
 AS-HHL19-01

1x 
 AS-DYF08-01

1x 
 AS-HHL19-03

1x 
 AS-HHL19-02

1x 
 AM78286CS

1x 
 AM78286NU



1x
AM17056BBG



2x
AM09838BOR



1x
AM81527HP



1x
AM09593AAD



7x
AM01087BMG



2x
AM01087ASU



4x
AM09493GD



1x
AM09493AAD



3x
AM77463AAD



2x
AM77463GD



1x
AM01847BDG



1x
AM79690CS



1x
AM01137AXT



4x
AM01313ASU

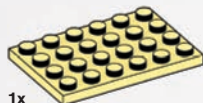

1x
AM17055CS



1x
AM08483CS

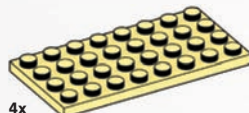

4x
AM17845CS

Missing pieces? Pièces manquantes?

¿Partes faltantes? • Perdeu peças?
Fehlende Teile? • Не хватает деталей?



support.megabrand.com

⚠ WARNING:
CHOKING HAZARD – Small parts.
Not for children under 3 years.

ATTENTION:
DANGER D'ÉTOUFFEMENT –
PETITS ÉLÉMENTS. NE
CONVIENT PAS AUX ENFANTS
DE MOINS DE 36 MOIS.

ATENÇÃO: NÃO INDICADO / NÃO RECOMENDÁVEL PARA CRIANÇAS MENORES DE 3 (TRÊS) ANOS POR CONTER PARTE(S)
PEQUENA(S) QUE PODE(M) SER ENGOLIDA(S) OU ASPIRADA(S) PODENDO PROVOCAR ASFIXIA.

WARNING: Small parts, ATTENTION : PETITS ÉLÉMENTS, ACHTUNG: Kleine Teile, AVVERTENZA: Piccole parti, WAARSCHUWING: Kleine onderdelen, ADVERTENCIA: PELIGRO DE ATRAGANTAMIENTO. Juguete no recomendado para menores de 3 años, porque contiene piezas pequeñas que podrían provocar asfixia en caso de ser ingeridas o inhaladas por el/la niño/a, VARNING: Små delar, VAROITUS: Pieniä osia, ADVARSEL: Små dele, ADVARSEL: Små deler, OSTRZEŻENIE: Małe części, UPOZORNĚNÍ: Malé části, UPOZORNENIE: Malé části, FIGYELMEZTETÉS: Kis alkatrészek, ПРЕДУПРЕЖДЕНИЕ: Мелкие детали, ΠΡΟΕΙΔΟΠΟΙΗΣΗ: Μικρά κομμάτια, UYARI: Küçük parçalar.

تحذير: قطع صغيرة.
のどにつまる危険 小さな部品が含まれています 3歳以下の子供には与えないで下さい。

警告! 不适合3岁以下儿童使用。内含小零件。



Town Scene / Scène de ville
Stadtabenteuer / Avventure in Città
Stadsgezicht / Paysage urbain
Cena da cidade / I staden
Byscene / Miasto / Scéna v městečku
Városi jelenet / Город
Στηνικό Τοποθεσία / Şehir Teması
Town Scene دمشق

**YOU CAN
CONNECT
THE SETS**

**TU PEUX
CONNECTER
LES ENSEMBLES**

¡PUEDES CONECTAR LOS
CONJUNTOS DE JUEGO!
PODES UNIR TODOS OS CONJUNTOS!
DIE SETS LASSEN SICH VERBINDEN!
НАБОРЫ МОЖНО СОЕДИНЯТЬ!



HTJ03

HTJ04



GFC85: GVK60, GVK61, GVK62, GVK63, GVK64, GVK65 / FPM00: HKT09, HKT10, HKT11, HKT12, HKT13, HKT14 / HPX92 / GWY77 / HKT25 / HKT26 / HPB59 / HKT21 / HNT93 / HHN61 / HKT23 / HFG06 / HDH93 / HNT95 / HHM17 / HTJ04

Set(s) sold separately and subject to availability. / Ensemble(s) vendu(s) séparément. Certains produits peuvent ne pas être commercialisés. / Se vende(n) por separado y está(n) sujeto(s) a disponibilidad. / Conjunto(s) vendido(s) em separado e sujeito(s) à disponibilidade. / Set in vendita separatamente, secondo disponibilità. / Das/Die Set(s) sind separat erhältlich. / Zestaw(y) sprzedawany(e) oddzielnie w zależności od dostępności. / Set(s) apart verkrijgbaar en afhankelijk van beschikbaarheid. / Набор(ы) продаются отдельно, при наличии. / Sæt sælges separat og så længe lager haves. / Seten säljs separat så länge lagret räcker. / Settet/settene selges separat så langt lageret rekker. / Pakkaus/pakkaukset myydään erikseen, saatavuus voi vaihdella. / Το(α) σετ πωλούνται ξεχωριστά και ανάλογα με τη διαθεσιμότητα. / Setler ayrı olarak satılır ve stoklarla sınırlıdır. / Set (sety) se prodává (prodávají) samostatně dle aktuální nabídky. / Súprava/-y sa predáva(jú) samostatne a podľa dostupnosti. / A készlet(ek) külön kapható(k), az elérhetőség változhat. / セット商品は別売りになります。在庫状況は別途ご確認をお願いします。/

تباع المجموعة أو المجموعات على حدة وتخضع لتوافرها.
每套单独发售，按供货情况决定。

Mattel Europa B.V., Gondel 1, 1186 MJ Amstelveen, Nederland. Mattel U.K. Limited, The Porter Building, 1Brunel Way, Slough SL1 1FQ, UK. Mattel France, P.V. de la Censière, 1/3/5 allée des Fleurs, 94260 Fresnes Cedex. № Cristal 0969 36 99 99 (Numéro non surtaxé) ou www.lesjouetsmattel.fr Mattel Belgium N.V. De Kleetlaan 4, 1831 Machelen (Diegem) Belgium. Deutschland : Mattel GmbH, Solmsstraße 83, D-60486 Frankfurt am Main. Schweiz: Mattel AG, Kirchstrasse 24, CH-3079 Liebefeld. Österreich: Mattel Ges.m.b.H., Campus 21, Liebermannstraße A01 404, A- 2345 Brunn/Gebirge. Mattel Italy Srl, Via Turati 4, 20121 Milano, Italy. Servizio assistenza clienti: Customersrv.it@mattel.com - Numero verde 800 11 37 11. Mattel España, S. A. Arriba 200 pl. 9, 08036 Barcelona. cserve.spain@mattel.com Tel: +34 933 06 79 00 <http://www.service.mattel.com/es>. Chinese mainland: Mattel Barbie (Shanghai), Trading Co., Ltd. Room 2005, 20th Floor, 899 Ruining Road, Xuhui District, Shanghai, 200232, P.R.C. Customer Care Line: 400-819-8658. Hong Kong SAR: Kids Kingdom Limited, Room 1908-9, Gala Place, 56 Dundas Street, Mongkok, Kowloon, Hong Kong, P.R.C. Customer Care Line: (852) 2787-0766. Taiwan region: CHICKABIDDY CO., LTD, F5, No. 186, Sec. 4, Nanjing E. Rd., Taipei 10595, Taiwan region. Customer Care Line: 0800 001 256. Diimport & Diedarkan Oleh: Mattel Continental Asia Sdn Bhd. Level 19, Tower 3, Avenue 7, No. 8 Jalan Kerinchi, Bangsar South, 59200 Kuala Lumpur, Malaysia. Mattel South Africa (PTY) LTD, Office 102 13, 30 Melrose Boulevard, Johannesburg 2196. Dystributor: Mattel Poland Sp. z o.o., Budynek Skyliner 31 p., ul. Prosta 67, 00-838 Warszawa, Polska. Mattel Australia Pty. Ltd., 658 Church St., Richmond, Victoria, 3121. Consumer Advisory Service - 1300 135 312. Mattel AEBE, Εθνάρχου Μικραίου 1, Κτήριο Κ-2, ΤΚ 17561, Παλαιό Φάληρο. Mattel Oyuncakçılık Tic. Ltd. Şti. İçerenceköy Mah., Umut Sokak No: 10-12, Quick Tower kat:2 işkanı no:15 Ataşehir 34752, İstanbul, Türkiye. Tel: 0216 570 75 00. Импортёр/Уполномоченная организация: ООО "МАТТЕЛ" Российская Федерация, 10520 Москва, 2-й Сыроматинский переулок 1; +7 495 287 79 39. Mattel Czech Republic s.r.o., The Forum, Václavské nám. 19, 11000 Praha1. Mattel, 333 Continental Boulevard, El Segundo, CA 90245, USA. Consumer Services: 1-800-465-MEGA (6342). Mattel Canada Inc., Mississauga, Ontario L5R 3W2. Consumer Services: You may call us free at / Composez sans frais le 1-800-524-8697. Importado y distribuido por Mattel de México, S.A. de C.V., Miguel de Cervantes Saavedra No. 193, Pisos 10 y 11, Col. Granada, Alcatraz Miguel Hidalgo, C.P. 11520, México, Ciudad de México. R.F.C. MME-920701-NB3. Tels.: 59-05-51-00-Ext. 5206 ó 01-800-465-59-89. Mattel Chile S.A., Pdte. Riesco 5561, Of. 203-204 PS2, Las Condes, Santiago. Servicio al consumidor Venezuela: Tel: 0-800-100-9123. Mattel Argentina, S.A., Av. Libertador 1000, PISO 11 - Oficinas 109 y 111, Vicente López - Prov. Buenos Aires. Tel.: 0800-666-3373. Mattel Colombia, S.A., Calle 123#7-07 P5, Bogotá. Mattel Perú, S.A., Av. Juan de Arona # 151, Centro Empresarial Juan de Arona, Torre C, Piso 7, Oficina 704, San Isidro, Lima 27, Perú. RUC: 20425853865. Reg. Importador: 02350-12-JUE-DIGESA. Tel: 0800-54744. E-mail Latinoamérica: servicioclientes@mattel.com. Mattel do Brasil Ltda. - CNPJ: 54.558.002/0001-20 - Rua Verbo Divino, 1488 - 2º. Andar - 04719-904 - Chácara Santo Antônio - São Paulo - SP - Brasil. Serviço de Atendimento ao Consumidor: Contato: <https://faleconosco.mattel.com.br/Contato> E-mail: sac.matteldobrazil@mattel.com.

©2023 Pokémon. ©1995–2023 Nintendo / Creatures Inc. / GAME FREAK inc. TM, ®, and character names are trademarks of Nintendo.

©2023 Pokémon. ©1995–2023 Nintendo/Creatures Inc./GAME FREAK inc. TM, ® et les noms des personnages sont des marques de Nintendo.



BUILD A WORLD OF POKÉMON CRÉEZ VOTRE UNIVERS POKÉMON



© D799,608, D834,105

1186 MJ, 1, NL

©2023 MEGA Brands &™ MEGA Brands.
Printed in China / Imprimé en Chine

AD-HTJ03-01A

™ & ©2023 Mattel.

Mattel Canada Inc. Mississauga, Ontario L5R 3W2.
MADE IN CHINA. FABRIQUÉ EN CHINE. FABRICADO NA CHINA. HECHO EN CHINA.
ИЗГОТОВЛЕНО В КИТАЕ. ÇIN'DE ÜRETİLMİŞTİR. صنع في الصين

[MEGAUNBOXED.COM](https://www.megaunboxed.com)

MATTEL

Empowering the
next generation
through play.™

Inspirer les futures générations par le jeu.



FR
DONNEZ
OU
RECYCLEZ



ASSOCIATION



MAGASIN



DÉCHÈTERIE

Adresses sur [quefairedemesdechets.fr](https://www.quefairedemesdechets.fr)

