



HALO



ODST BUCK

HMV51

ODST WOMBAT OVERWATCH

WOMBAT ODST EN SOUTIEN

SUPERVISIÓN DEL WOMBAT DE SCDO | WOMBAT ODST DE SUPORTE

HALO
UNIVERSE



Build | Construisez

Construye | Constrói

Bauen | Стройте



Share | Partagez

Comparte | Partilha

Teilen | Делитесь

Devices not included | Appareils non inclus
Dispositivos não incluído | Dispositivos não
incluídos | Geräte nicht enthalten
Устройства не входят в комплект



megaunboxed.com



1

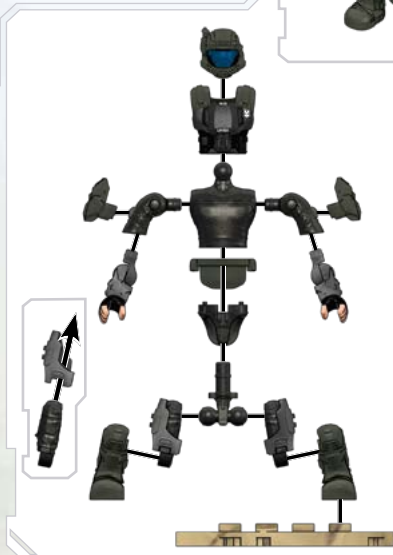



2



1X



1X



2X

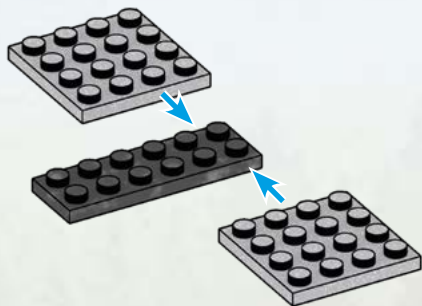

1

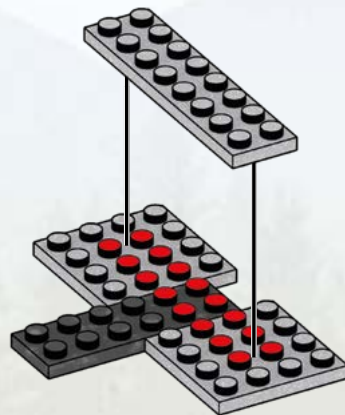

2

3

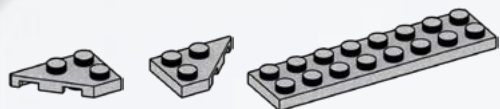

1X

1X

1X

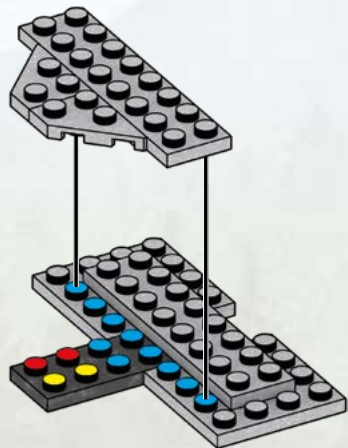

4

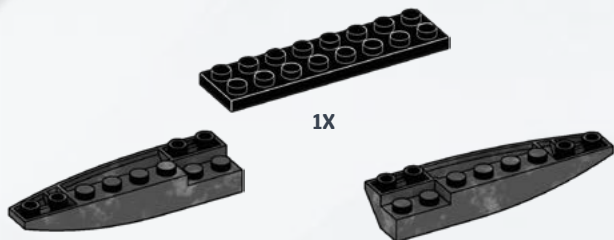

1X

1X

1X

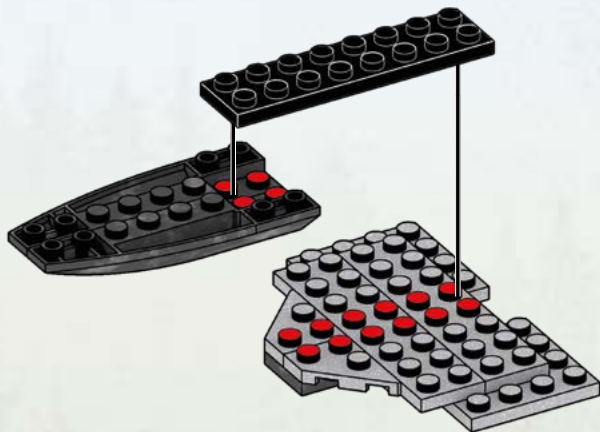

5



2X

1X

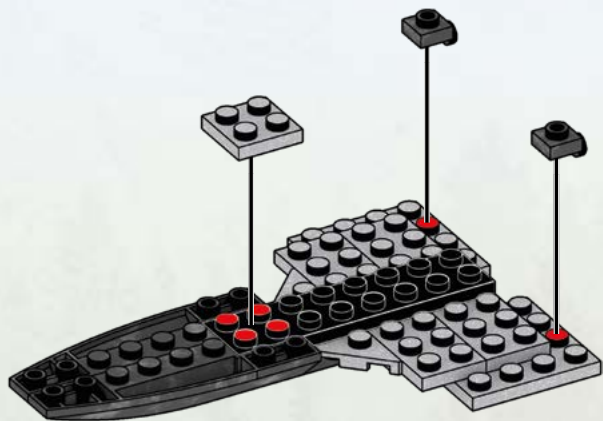

6

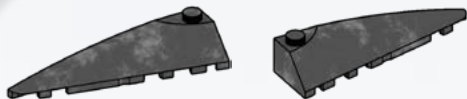

1X

1X



7

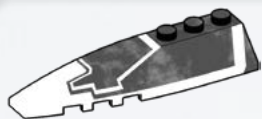

1X

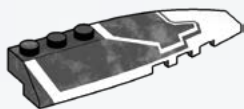

1X

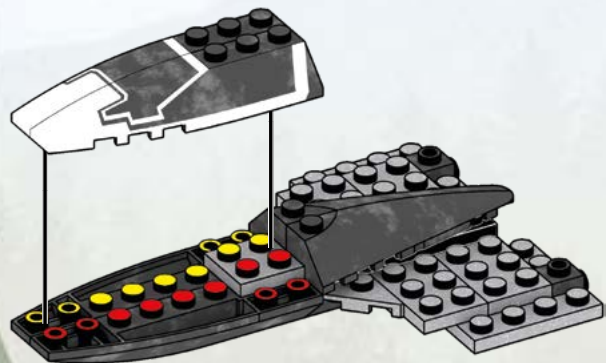

1

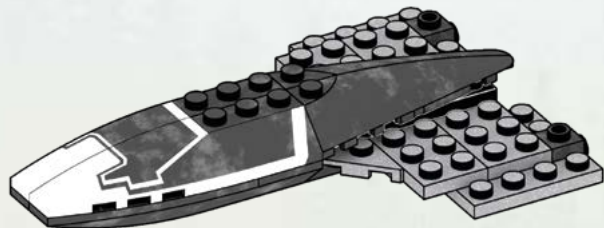

2

8



2X



2X



1X

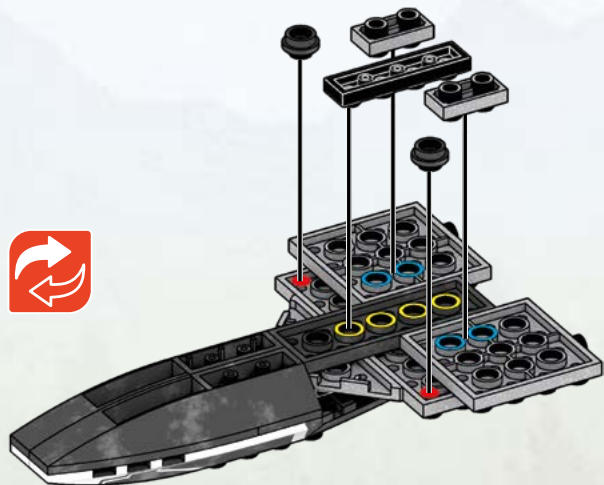

1

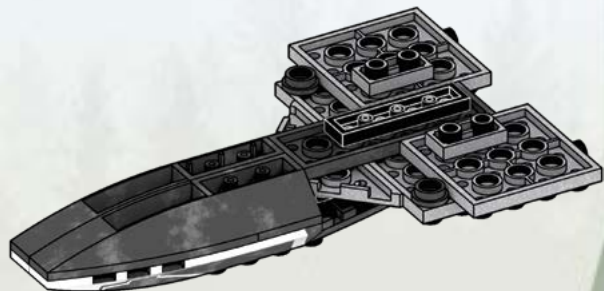

2

9

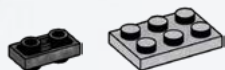

1X

1X



1X

10



1X



2X



1X

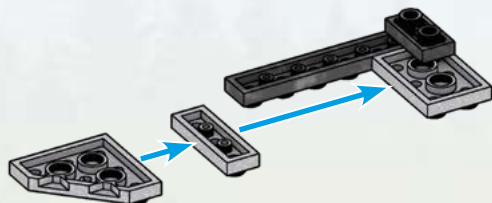
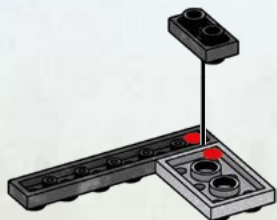

1

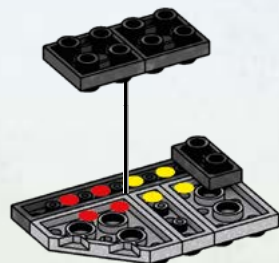

2

11



1X



1X



1X

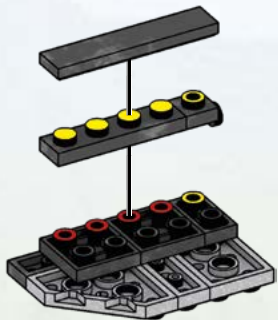

12



1X



2X

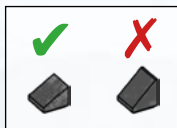

1

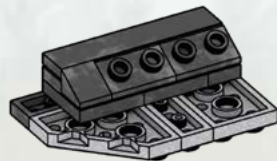

2

13

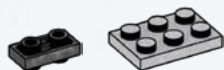

1X

1X



1X

14



1X



2X



1X

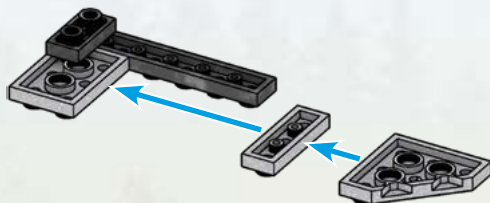
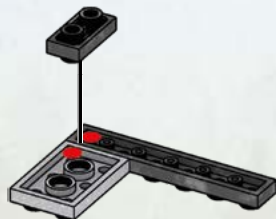

1



2

15



1X

1X

1X

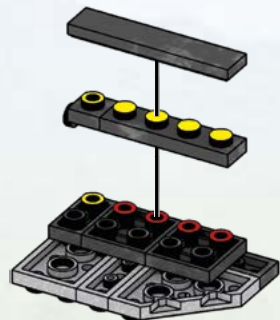

16



1X

2X

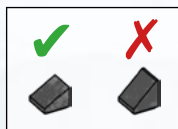

1



2

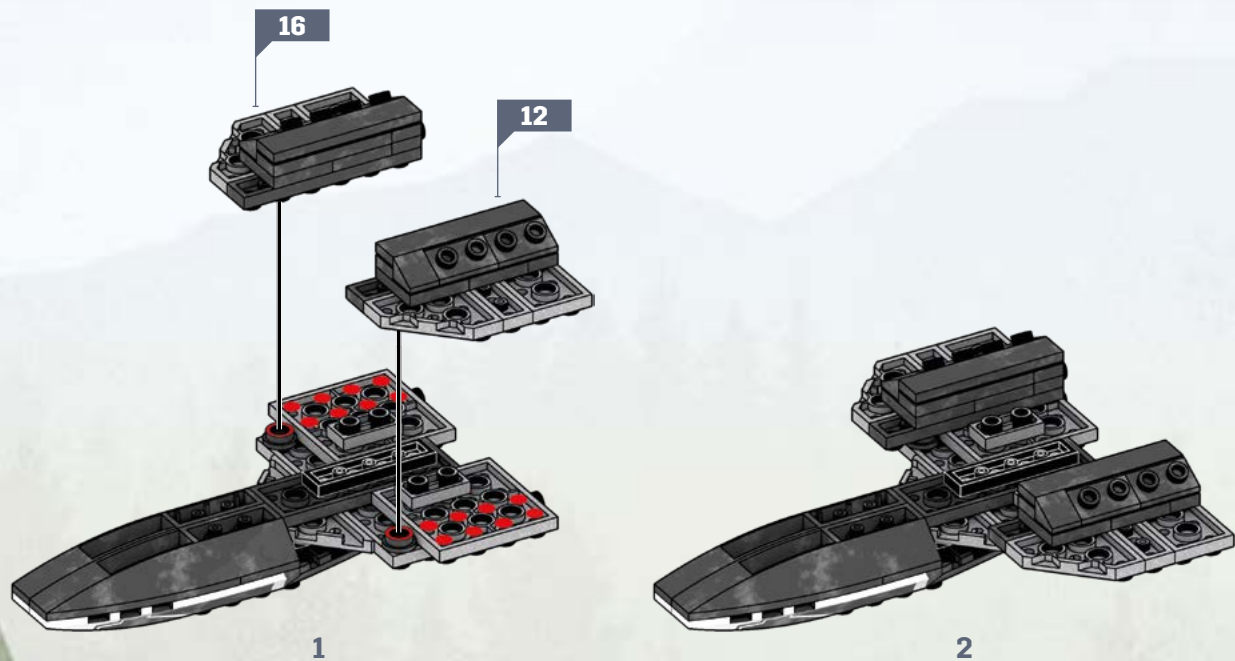

18



2X

4X

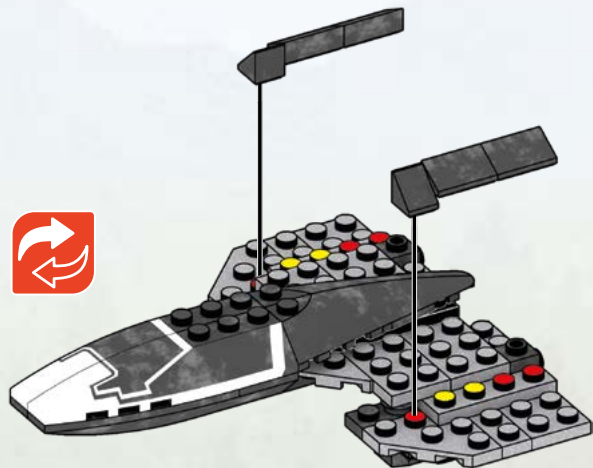

19



2X

2X

2X

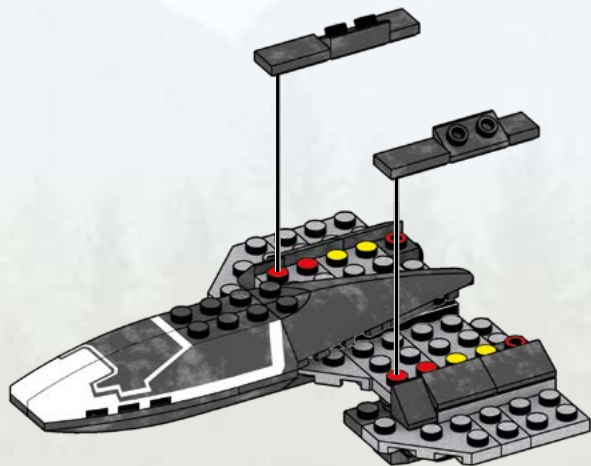

20



1X



1X

21



1X



1X



1



2



1



2

22



1X



1X

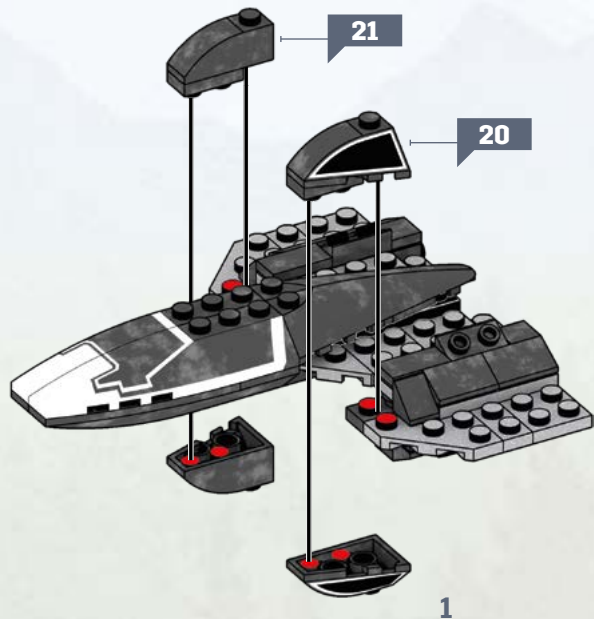

1

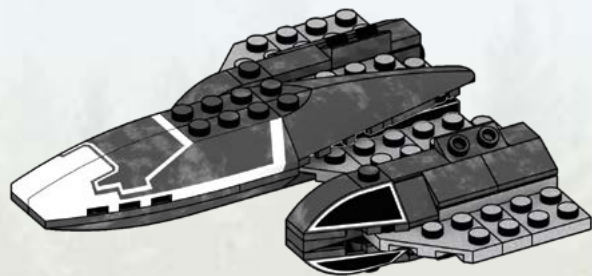

2

23



2X

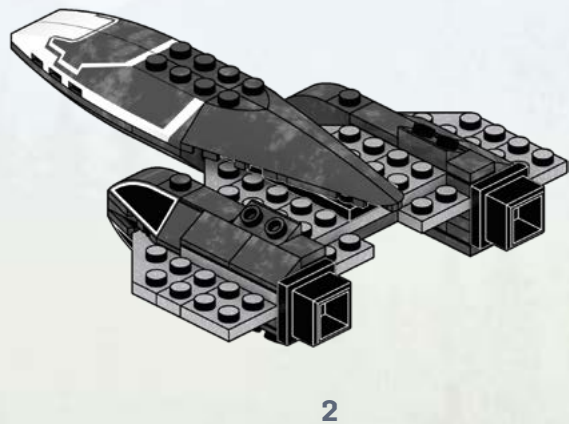
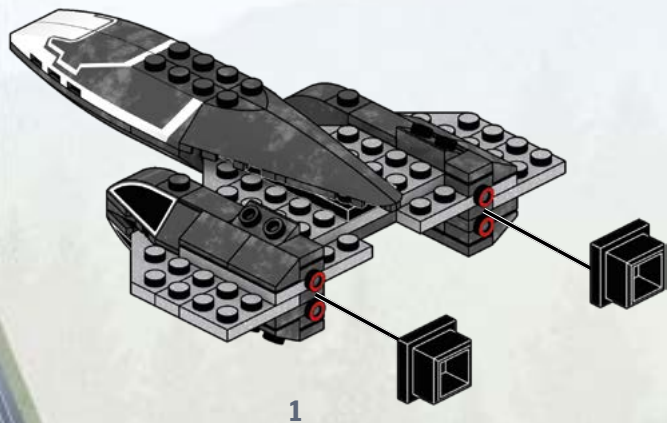

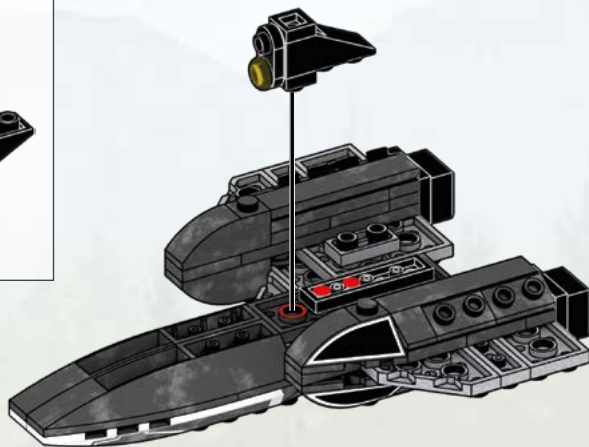
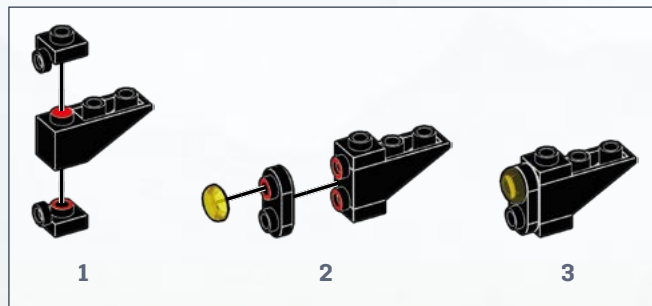

25



x2

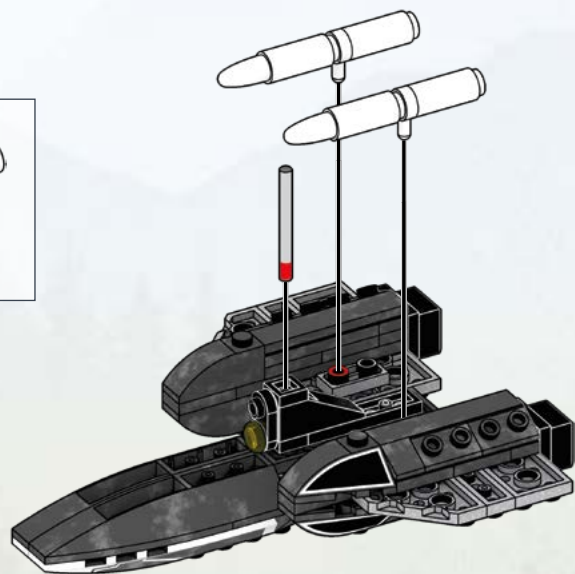
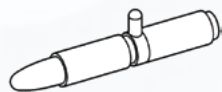
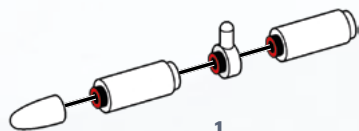

26

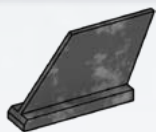

2X

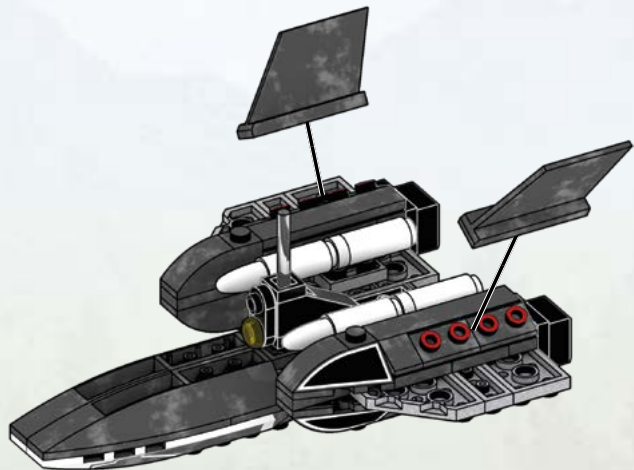

1

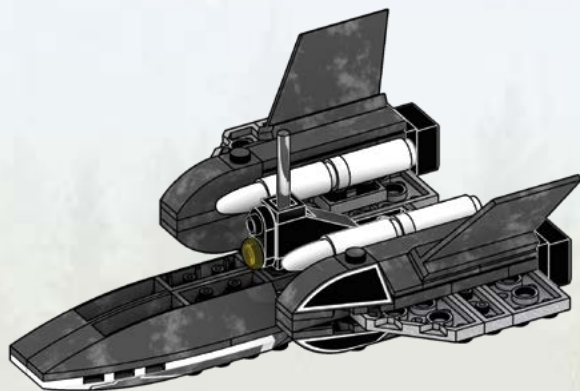

2

27



2X

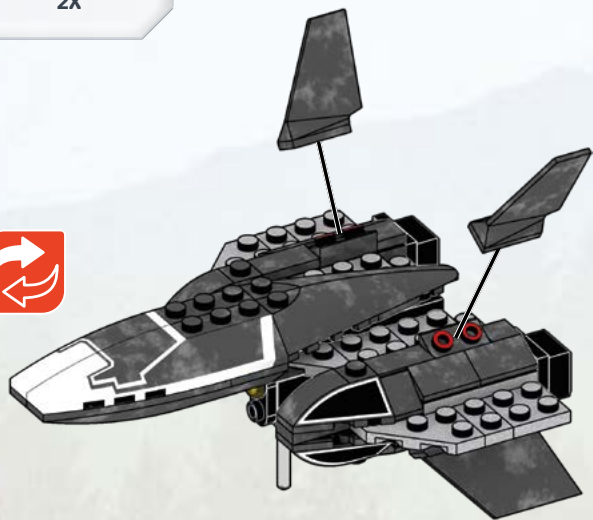

1

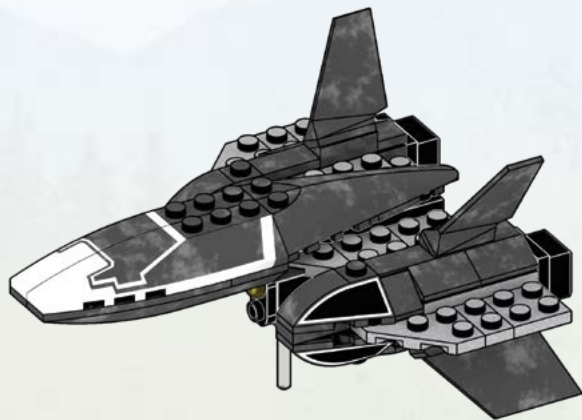

2



BRUTE MINOR



ODST BUCK



1x
AM75332ZD



2x
AM18560AJL



2x
AM79432E



2x
AM07223AJL



4x
AM77574AJL



1x
AM77574F



1x
AM79590F



2x
AM01312E



4x
AM09129E



2x
AM17127AJL



2x
AM15258AJL



2x
AM022501AJL



1x
AM80174F



4x
AM16680AJL



2x
AM16680APG



6x
AM18272AJL



1x
AS-HMV51-05



4x
AM18549AJL



1x
AM03773APG



4x
AM01146AJL



2x
AM07578F



2x
AM01314APG



1x
AM01418F



1x
AM76205APG



1x
AM76206APG



2x
AM03772APG



1x
AM76521W



2x
AS-HMV51-03



2x
AS-HMV51-04



2x
AM18279APG



2x
AM09593AJL



1x
AM09593F



2x
AM17793AJL



2x
AM76357ANW



2x
AM17054APG



2x
AM17612AJL



2x
AM78477AJL



2x
AM09292AJL



1x
AM01480AJL



2x
AM08483APG



1x
AM08483F



1x
AM74770AJL



1x
AM74771AJL



1x
AS-HMV51-01



1x
AS-HMV51-02





1x
AM09187AJL



1x
AM09186AJL



1x
AM79107MM



1x
AM19232AXW



1x
FIG-HMV51-A



1x
FIG-HMV51-B

Missing pieces? Pièces manquantes?

¿Partes faltantes? • Perdeu peças?
Fehlen Teile? • Не хватает деталей?

support.megabrand.com



© 2022 Microsoft Corporation. All Rights Reserved.
Microsoft, Halo, the Halo logo, Xbox, the Xbox logo,
and 343 Industries are trademarks of the Microsoft
group of companies.

Ⓟ D714,887, D781,964, D797,203, D841,101

ODST Wombat Overwatch / Wombat ODST en Soutien / Supervisión del Wombat de SCDO / Wombat ODST de Suporte
Pattuglia Wombat ODST / ODST Wombat Überwachungsdrohne / ODST Wombat – Obserwacja / ODST Wombat op uitkijk
Наблюдение UNSC “Вомбат” ODST Αεροσκάφος Υποστήριξης / ODST Wombat Desteği / ODST Wombat katonai támogatás
ODST Wombat Overwatch / ODST Wombat Overwatch / ODST Wombat overwatch / ODST Wombat Overwatch / Hlídká
ODST Wombat / مركبة المراقبة ODST Wombat Overwatch

Mattel Europa B.V., Gondel 1, 1186 MJ Amstelveen, Nederland. Mattel U.K. Limited, The Porter Building, 1 Brunel Way, Slough SL1 1FQ, UK. Mattel France, Parc de la Cerisaie, 1/3/5 allée des Fleurs, 94260 Fresnes Cedex. N° Cristal 0969 36 99 99 (Numéro non sur-taxé) ou www.lesjouetsmattel.fr Mattel Belgium, Trade Mart, Atomiumsquare, Bogota 202 – B 275, 1020 Brussels. Gratis nummer België: 0800 – 16 936 – Gratis nummer Luxemburg: 800 – 22 784 – Gratis nummer Nederland: 0800 – 262 88 35. Deutschland: Mattel GmbH, Solmsstraße 4, D-60486 Frankfurt am Main. Schweiz: Mattel AG, Kirchstrasse 24, CH-3097 Liebefeld. Österreich: Mattel Ges.m.b.H., Campus 21, Liebermannstraße A01 404, A-2345 Brunn/Gebrige. Mattel Italy Srl, Via Bracco, 6-MAC 6, 20159 Milano, Italy. Servizio assistenza clienti: Customersrvitalia@mattel.com - Numero verde 800 11 37 11. Mattel España, S.A., Aribau 200, 08036 Barcelona. cservice.spain@mattel.com Tel: 900 102 390 <http://www.service.mattel.com/es>. Mattel East Asia Ltd., Room 503-09, North Tower, World Finance Centre, Harbour City, Tsimshatsui, HK, China. Tel: (852) 3185-6500. Diimport & Diedarkan Oleh: Mattel Continental Asia Sdn Bhd. Level 19, Tower 3, Avenue 7, No. 8 Jalan Kerinci, Bangsar South, 59200 Kuala Lumpur, Malaysia. Mattel South Africa (PTY) LTD, Office 102 I3, 30 Melrose Boulevard, Johannesburg 2196. Distributor: Mattel Poland Sp. z o.o., Warsaw Trade Tower 34 p., ul. Chlodna 51, 00-867 Warszawa. Mattel Australia Pty. Ltd., 658 Church St., Richmond, Victoria, 3121. Consumer Advisory Service - 1300 135 312. Mattel AEBE, Евънъору Макарори 1, Кръго К-2, ТК 17561, Палайо Фолгро. Mattel Oynacaklık Tic. Ltd. Şti. İçerenköy Mah., Erkut Sok. A Blok No:12 Üner Plaza Kat:9-10 34752 Ataşehir İstanbul. Tel: 0216 570 75 00. Уполномоченная организация: ООО “МАТТЕЛ” Российская Федерация, 105120 Москва, 2-й Сыромятинский переулок, 1; +7 495 287 79 39. Mattel Czech Republic s.r.o., The Forum, Václavské nám. 19, 11000 Praha 1. Mattel, 333 Continental Boulevard, El Segundo, CA 90245, USA. Mattel Canada Inc., Mississauga, Ontario L5R 3W2. Consumer Services: You may call us free at/ Composez sans frais le 1-800-524-8697. Importado y distribuido por Mattel de México, S.A. de C.V., Miguel de Cervantes Saavedra No. 193, Pisos 10 y 11, Col. Granada, Alcaldía Miguel Hidalgo, CP. 11520, México, Ciudad de México. R.F.C. MME-920701-NB3. Tels: 59-05-51-00 Ext. 5206 ó 01-800-463-59-89. Mattel Chile, S.A., Avenida América Vespucio 501-B, Quilicura, Santiago. Tel: 1230-020-6213. Servicio al consumidor Venezuela: Tel: 0-800-100-9123. Mattel Argentina, S.A., Av. Libertador 1000, Piso 11 – Oficinas 109 y 111, Vicente López – Prov. Buenos Aires. Tel: 0800-666-3373. Mattel Colombia, S.A., Calle 123#-07 P5, Bogotá. Tel: 01800-710-2069. Mattel Perú, S.A., Av. Juan de Arona # 151, Centro Empresarial Juan de Arona, Torre C, Piso 7, Oficina 704, San Isidro, Lima 27, Perú. RUC: 20425853865. Reg. Importador: 02350-12-JUE-DIGESA. Tel: 0800-54744. E-mail Latinoamérica: servicio.clientes@mattel.com. Mattel do Brasil Ltda.- CNPJ: 54.558.002/0001-20 - Rua Verbo Divino, 1488 - 2º Andar - 04719-904 - Chácara Santo Antônio - São Paulo - SP - Brasil. Serviço de Atendimento ao Consumidor: fone 0800 575 0780. E-mail: sac.matteldobrazil@mattel.com



HALO



ODST BUCK



BRUTE MINOR



HMV56



HNC75



HMC51



HMC75

Set(s) sold separately and subject to availability. / Ensemble(s) vendus séparément. Certains produits peuvent ne pas être commercialisés. / Se vende(n) por separado y está(n) sujeto(s) a disponibilidad. / Conjunto(s) vendido(s) em separado e sujeito(s) à disponibilidade. / Set in vendita separatamente, secondo disponibilità. / Das/Die Set(s) sind separat erhältlich. / Zestaw(y) sprzedawany(eg) oddzielnie w zależności od dostępności. / Set(s) apart verkrijgbaar en afhankelijk van beschikbaarheid. / Набор(ы) продается(ются) отдельно, при наличии. / Sæt sælges separat og så længe lager haves. / Seten säljs separat så länge lagret räcker. / Settet/ettene selges separat så lenge lagret rekker. / Pakkaus/pakkaukset myydään erikseen, saatavuus voi vaihdella. / Το(α) σετ(α) που πωλούνται ξεχωριστά και ανύφανα με τη διαθεσιμότητα. / Setler ayrı olarak satılır ve stoklara sinirlidir. / Set (sety) se prodává (prodávají) samostatně dle aktuální nabídky. / Súprava/-y sa predáva(jú) samostatne a podľa dostupnosti. / A készlet(ek) külön kapható(k), az elérhetőség változhat. /

セット商品は別売りになります。在庫状況は別途ご確認をお願いします。 / تباع المجموعة أو المجموعات على حدة وتخضع لتوافرها. /

每套单独发售，按供货情况决定。

1186 MJ, 1, NL



Mattel Canada Inc. Mississauga, Ontario L5R 3W2.
MADE IN CHINA. FABRIQUÉ EN CHINE. FABRICADO NA / HECHO EN CHINA.
ИЗГОТОВЛЕНО В КИТАЕ. ÇIN'DE ÜRETİLMİŞTİR. صنع في الصين

©2022 MEGA Brands &™ MEGA Brands.
Printed in China / Imprimé en Chine
AD-HMV51-01

