

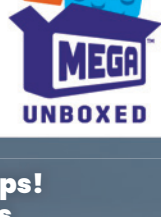

HKT17
UNSC MONGOOSE OUTRIDERS
ESCORTE MONGOOSE DE L'UNSC
ESCOLTA MONGOOSE DEL UNSC / ESCOLTA UNSC MONGOOSE

HALO INFINITE



Build
Construisez
 Construye | Constrói
 Bauen | Стройте



Share
Partagez
 Comparte | Partilha
 Teilen | Делитесь

Get the 2-in-1 rebuild steps!
Accédez aux instructions de reconstruction des jouets 2-en-1!

¡Consigue los pasos de reconstrucción 2 en 1! | Obtém os passos de reconstrução 2 em 1! | Jetzt die 2-in-1-Schritte für die zweite Baumöglichkeit entdecken! | Получите инструкции по сборке игрушки 2-в-1!

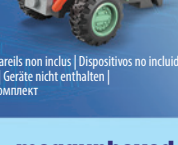

Devices not included | Appareils non inclus | Dispositivos no incluido | Dispositivos não incluídos | Geräte nicht enthalten | Устройства не входят в комплект

megaunboxed.com



1

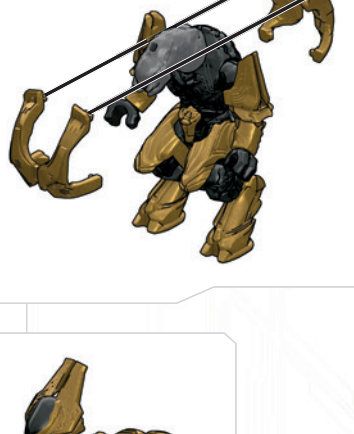
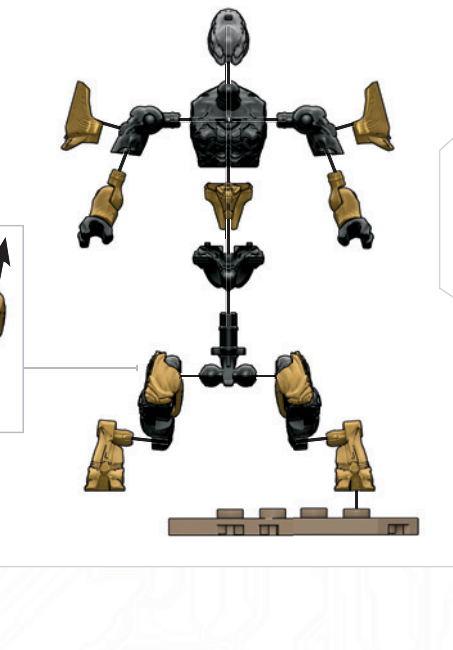
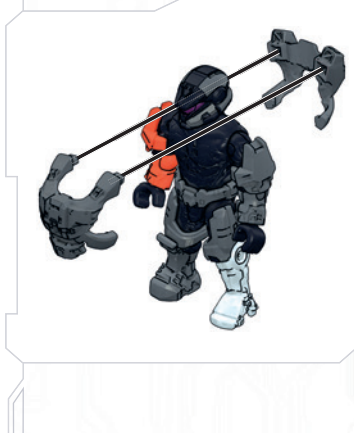
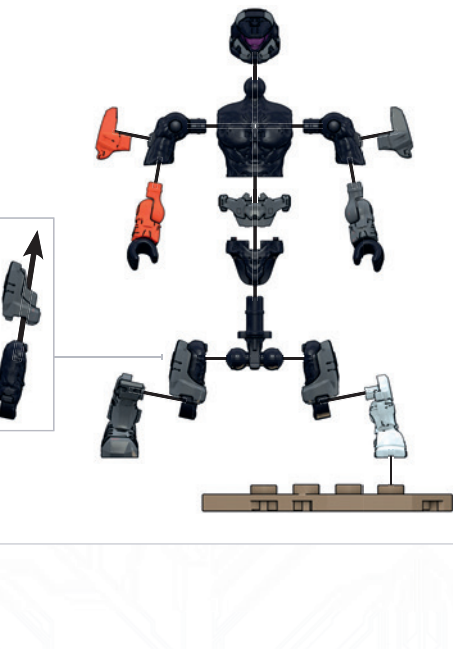
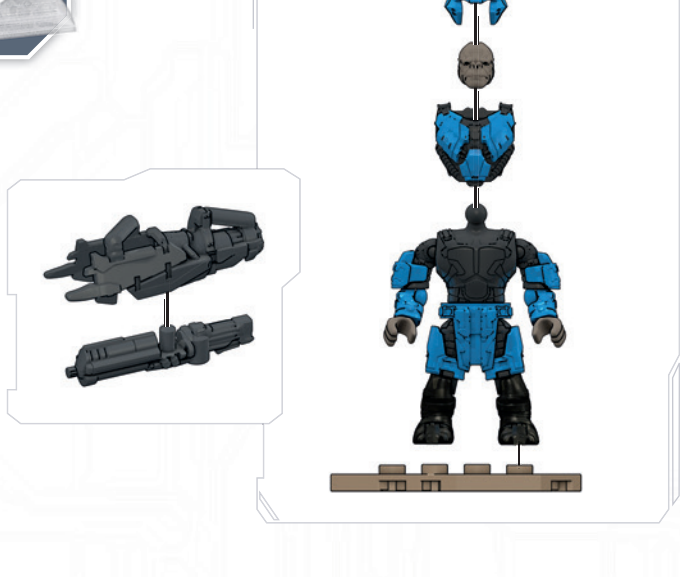

Most models can be built one at a time. La plupart des modèles peuvent être construits un à la fois. La mayoría de modelos se pueden construir de uno en uno. A maioria dos modelos pode ser construída separadamente. La maggior parte dei modelli possono essere realizzati uno per volta. Die meisten Modelle können eines nach dem anderen gebaut werden. Większości modeli nie da się budować jednocześnie z innymi. De meeste modellen kunnen één voor één gebouwd worden. Большинство моделей могут быть собраны по одной за раз. De fleste modeller kan bygges enkeltvis. De flesta modeller kan byggas en i taget. De fleste modellene kan bygges en om gangen. Useimmat mallit voidaan rakentaa yksi kerrallaan. Τα περισσότερα μοντέλα μπορούν να κατασκευασθούν ένα ένα. Modellerein çoğu ayrı ayrı inşa edilmeyi gerektirebilir. Vétşinou lze najednou sestavit pouze jeden model. Väčšina modelov môže byť zostavená iba raz. A modellek többségéből egyszerre csak egy építhető. ほとんどのモデルは、一度に一つを組み立てることができます。 يمكن تركيب التصاميم الواحد تلو الآخر. 大多數型號可一次性建構

BUILDING TOOL
OUTIL DE CONSTRUCTION

HERRAMIENTA DE CONSTRUCCIÓN
 BUILDWERKZEUG
 FERRAMENTA DE MONTAGEM
 ИНСТРУМЕНТ ДЛЯ КОНСТРУИРОВАНИЯ

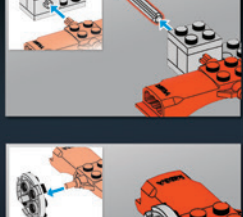
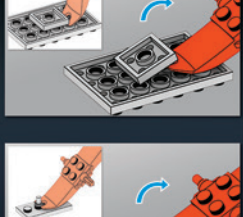
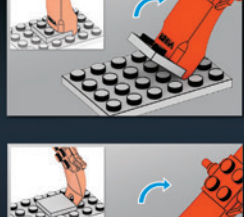

2

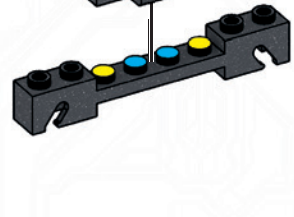

3

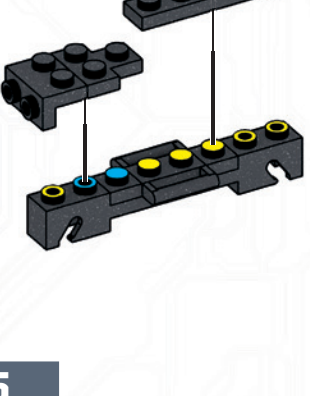
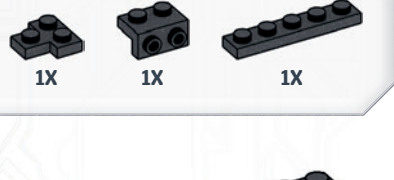

4

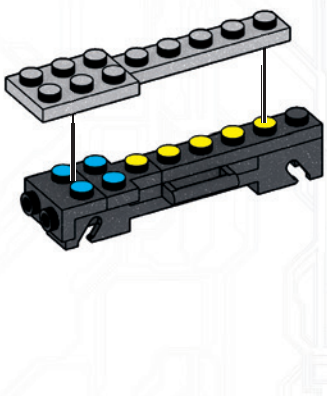
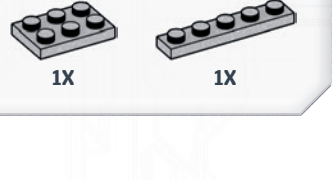

5

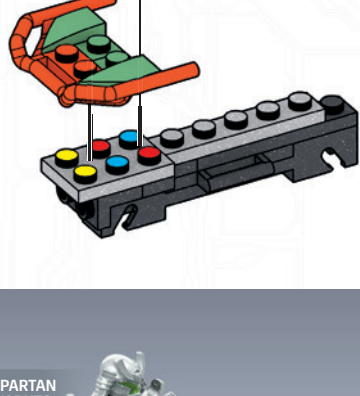

Mattel Canada Inc. Mississauga, Ontario L5R 3W2.
 MADE IN CHINA. FABRIQUÉ EN CHINE. FABRICADO NA CHINA. HECHO EN CHINA. ИЗГОТОВЛЕНО В КИТАЕ. ÇİN'DE ÜRETİLMİŞTİR. صنع في الصين.
 1186 MJ, 1, NL P#D714.887, D841,101

©2022 MEGA Brands &™ MEGA Brands. Printed in China / Imprimé en Chine. AD-HKT17-01B



6

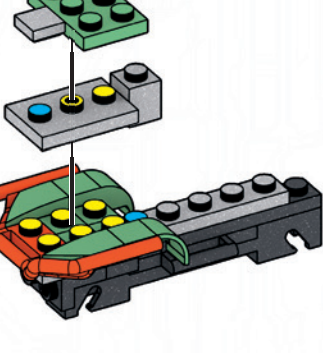

7

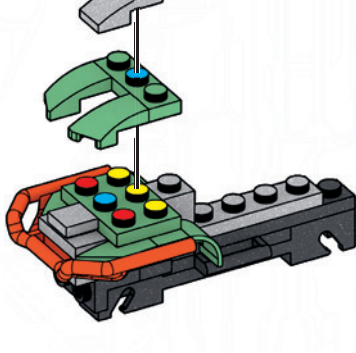

8

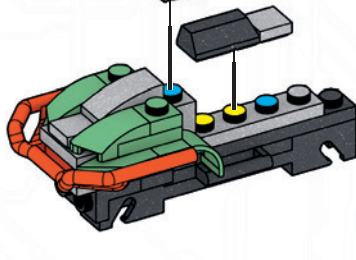
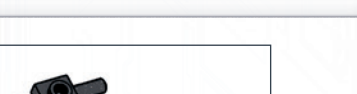

9

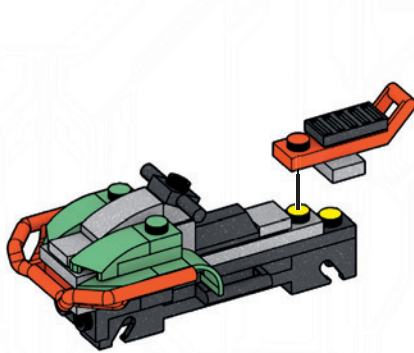
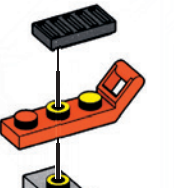

10

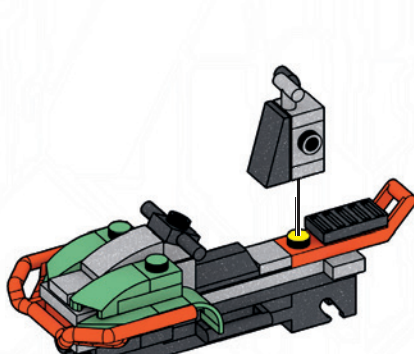
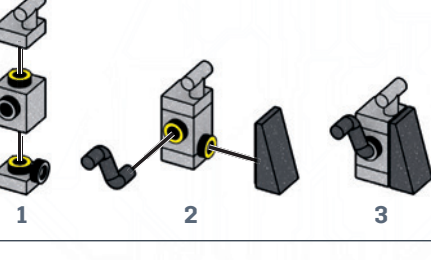

11

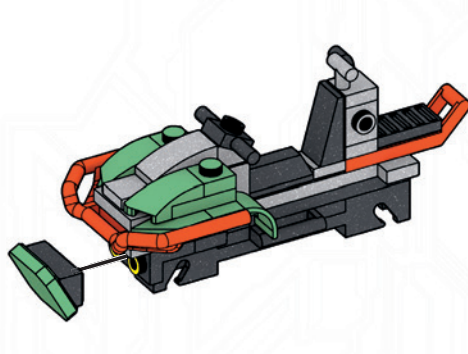
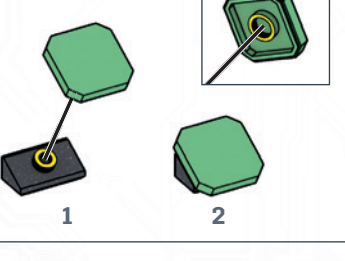
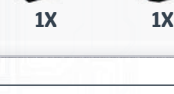

12

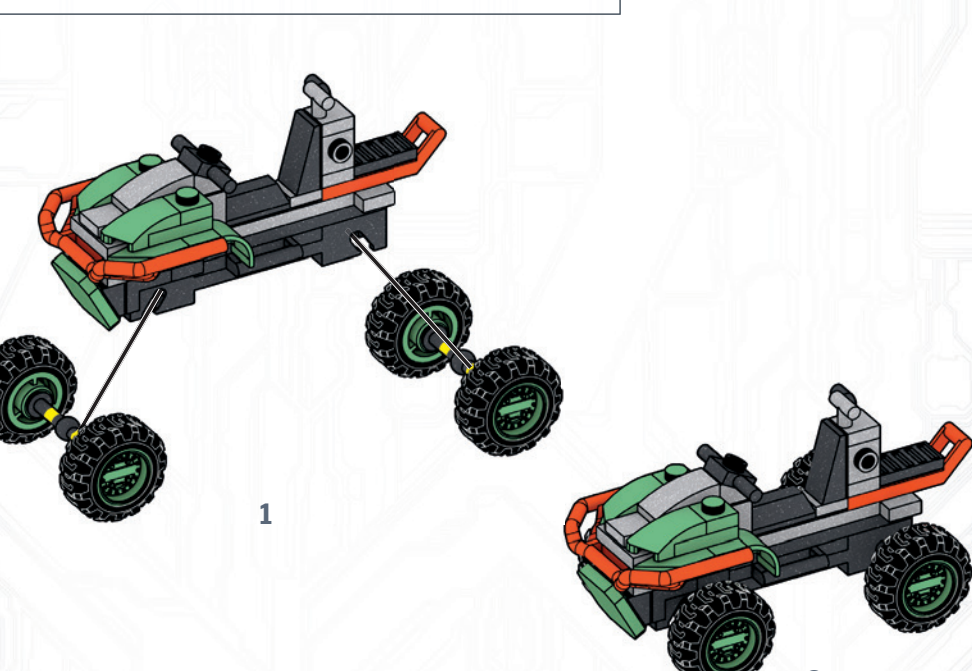

x2

CONTENTS / CONTIENT / INHALT / CONTENUTO / INHOUD / CONTENIDO / CONTEÚDO / INNEHÅLL / SISÄLTÖ / INDEHOLDER / INNHOVD / ZAWIERA /
 OBSAH / TARTALOM / СОДЕРЖИМОЕ / ПЕРІХОМЕНА / İÇİNDEKİLER / المحتويات

2x AM07223APG	1x AM09198MM	1x AM73906MM	1x AM18014MM	2x AS-HKT17-01
2x AM03328MM	1x AM07590APG	1x AM76461AXT	1x AM73862MM	2x AS-HKT17-02
1x AM79590APG	1x AM73989MM	1x AM76462AXT	1x AM01314AXT	1x AM07475MM
1x AM72001APG	1x AM74427AXT	1x AM80767AXT	1x AM72439MCX	1x AM07475APG
1x AM15486APG	1x AM74426AXT	1x AM80768AXT	1x AM17509APG	4x AM76357ASE
1x AM73904MM	1x AM78486APG	1x AM18293MM	1x AM03772AXT	2x AM80797MM
1x AM01086APG	1x AM17128MM	1x AM18543AXT	1x AM03772APG	
1x AM17507APG	1x AM18232MM			

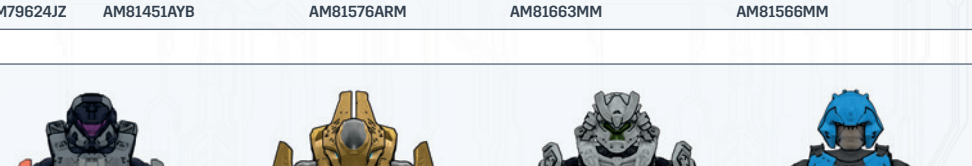

Missing pieces? • Pièces manquantes?
 ¿Partes faltantes? • Perdeu peças?
 Fehlen Teile? • Не хватает деталей?

support.megabrands.com

XBOX 343 INDUSTRIES

© 2022 Microsoft Corporation. All Rights Reserved. Microsoft, Halo, the Halo logo, Xbox, the Xbox logo, and 343 Industries are trademarks of the Microsoft group of companies.

Mattel Europe B.V., Gondel 1, 1186 MJ Amstelveen, Nederland. Mattel U.K. Limited, The Porter Building, 1 Brunel Way, Slough SL1 1FQ, UK. Mattel France, Parc de la Cristalle, 1/3/5 allée des Fleurs, 94260 Frettes Cedex. N° Cristal 0969 36 99 99 (Numéro non surtaxé) ou www.lesjouetsmattel.fr Mattel Belgium, Trade Mart, Atomiumsquare, Bogota 202 – B 275, 1020 Brussels. Gratis nummer België: 0800 – 16 936 – Gratis nummer Luxemburg: 800 – 22 784 – Gratis nummer Nederland: 0800 – 262 88 35. Deutschland: Mattel GmbH, Solmsstraße 83, D-60486 Frankfurt am Main. Schweiz: Mattel AG, Kirchstrasse 24, CH-3097 Liebefeld. Österreich: Mattel Ges.m.b.H., Campus 21, Liebermannstraße A01 404, A- 2345 Brunn/Gebirge. Mattel Italy Srl, Via Turati 4, 20121 Milano, Italy. Servizio assistenza clienti: Customersrv. italia@mattel.com – Numero verde 800 11 37 11. Mattel España, S.A, Aribau 200 pl. 9, 08036 Barcelona. cservice.spain@mattel.com Tel.: +34 933 06 79 00 http://www.service.mattel.com/es. Mattel East Asia Ltd., Room 503-09, North Tower, World Finance Centre, Harbour City, Tsimshatsui, HK, China. Tel.: (852) 3185-6500. Diimport & Diedarkan Oleh: Mattel Continental Asia Sdn Bhd. Level 19, Tower 3, Avenue 7, No. 8 Jalan Kerinci, Bangsar South, 59200 Kuala Lumpur, Malaysia. Mattel South Africa (PTY) LTD, Office 10213, 30 Melrose Boulevard, Johannesburg 2196. Dystributor: Mattel Poland Sp. z o.o., Warszawa Trade Tower 34 p., ul. Chłodna 51, 00-867 Warszawa. Mattel Australia Pty. Ltd., 658 Church St., Richmond, Victoria, 3121. Consumer Advisory Service - 1300 135 312. Mattel A&E: Εθνικού Μοξαρίου 1, Κηφισό Κ.2, ΤΚ 17561, Πολυώφ.Θεσσαλονίκης. Mattel Oyuncakçılık Tic. Ltd. Şti İçerenköy Mah., Umut Sok. No:10-12 Quick Tower Kat:2/15 34752 Ataşehir İstanbul Tel:0216 570 75 00. Матгелгэгэжүүлэгчдийн хамт олонгийн байр: ООО "МАТТЕЛ" Россияская Федерация, 105120 Москва, 2-й Сапрыгиный переулок, 1; +7 495 287 79 39. Mattel Czech Republic s.r.o. The Forum, Václavské nám. 19, 11000 Praha1. Mattel, 333 Continental Boulevard, El Segundo, CA 90245, USA. Consumer Services: 1-800-465-MEGA (6342). Mattel Canada Inc., Mississauga, Ontario L5R 3W2. Consumer Services: You may call us free at/ Ciudad sans frais le 1-800-524-8697. Importado y distribuido por Mattel de México, S.A. de C.V., Miguel de Cervantes Saavedra No. 193, Pisos 10 y 11, Col. Granada, Alcaldía Miguel Hidalgo, C.P. 11520, México, Ciudad de México. R.F.C. MME-920701-NB3. Tels.: 59-05-51-00 Ext. 5206 ó 01-800-463-59-89. Mattel Chile, S.A., Avenida Américo Vespucio 501-B, Quilicura, Santiago, Tel.: 1230-020-6213. Servicio al consumidor Venezuela: Tel.: 0-800-100-9123. Tels.: 59-05-51-00 Ext. 5206 ó 01-800-463-59-89. Mattel Peru, S.A., Av. Juan de Arona # 151, Centro Empresarial Juan de Arona, Torre C, Piso 7, Oficina 704, San Isidro, Lima 27, Perú. RUC: 20425853865. Reg. Importador: 02350-12-JUE-DIGESA. Tel.: 0800-54744. E-mail Latinoamérica: servicioalcliente@mattel.com. Mattel do Brasil Ltda. - CNPJ: 54.558.002/0001-20 - Rua Verbo Divino, 1488 - 2º Andar - 04719-904 - Chácara Santo Antônio - São Paulo - SP - Brasil. Serviço de Atendimento ao Consumidor: fone 0800 575 0780. E-mail: sac.matteldobrazil@mattel.com