



Technical Guideline: Bitumen Stabilised Materials

*A Guideline for the Design and Construction of Bitumen Emulsion and
Foamed Bitumen Stabilised Materials*

TG2 Third Edition August 2020



excellence in bituminous products

Published by
Southern African Bitumen Association (Sabita)

Postnet Suite 56, Private Bag X21
Howard Place, 7450, South Africa
Tel: +27 21 531 2718
Fax: +27 21 531 2606

Email: info@sabita.co.za

First published in 2002
ISBN 978-1-874968-77-1
Copyright © 2020 Sabita

DISCLAIMER

Considerable effort has been made to ensure the accuracy and reliability of the information contained in this publication. However, neither Sabita nor any of its members can accept liability for any loss, damage or injury whatsoever resulting from the use of this information. The content of this publication does not necessarily represent the views of any members of Sabita.

Copyright notice: This document and the contents of these pages are the Southern African Bitumen Association (Sabita). This document is made available to Members of Sabita as a service and is intended for the sole use of such Members, who may reproduce this document in whole or in part for the purpose of implementation of the systems described herein. All other rights are reserved. Any other use requires the prior written permission of Sabita.

FOREWORD

The first best practice manual that captured foamed bitumen technology was the TG2 manual published in 2002. It covered the design and construction of foamed bitumen treated materials. Prior to this, Sabita published two emulsion stabilisation best practice guidelines, namely Manual 14 – GEMS, The Design and Use of Granular Emulsion Mixes and Manual 21 – ETB, The Design and Use of Emulsion Treated Bases. In 2009, the second edition of TG2 took the bold step of developing a generic guideline for Bitumen Stabilised Materials. This included common mix design, structural design and construction procedures using bitumen emulsion technology and foamed bitumen technology.

A decade later, TG2 was ready for a revision. The last 10 years have yielded full scale implementation in every continent except the Antarctic and project data that includes:

- In excess of 350 mix designs that include triaxial testing in addition to the evaluation of other engineering properties of BSMs;
- Development of appropriate testing protocols to standardise the mix design procedures in South Africa (and abroad);
- Abundant project investigations with records of pavement details, allowing the materials classification system to be updated and the mix design procedures to be overhauled and refined; and
- Numerous structural pavement designs as well as LTPP data from more than 30 road sections incorporating BSM-emulsion and BSM-foam layers. This has enabled the Pavement Number heuristic design system to be recalibrated thus eliminating inherent biases. At the same time, a mechanistic design function has been developed for BSM pavement structures.

This TG2 publication in 2020 also addresses gaps in the application of cold recycling technology. A new chapter is introduced to provide best practice guidelines for pavement evaluation and rehabilitation design strategy. The 2009 edition of TG2 was weighted towards technology application using in place recycling. In the past decade, in plant recycling has gained a strong foothold and hence additions in the guidelines to share the latest developments.

This TG revision will play an important role in effectively uplifting the sustainability profile of pavement engineering. Reduced energy consumption and emissions, recycling and reuse of strategic resources and cost-effective solutions in maintaining road infrastructure are at the core of cold recycling technology. TG2 will remain a living document, with revisions that improve efficiency, reliability and performance of bitumen stabilisation technology.

Commercial Software packages are available in South Africa that cover the Pavement Number PN Design System and the Design Equivalent Material Classification DEMAC system. At the same time, the TG2 (2020) provides sufficient information for pavement engineers to develop their own version of both of these systems, in a spreadsheet.

MANUALS PUBLISHED BY SABITA

Manual 1	Technical guidelines: Construction of bitumen rubber seals
Manual 2	Bituminous binders for road construction and maintenance (under review)
Manual 3	(Withdrawn)
Manual 4	(Withdrawn)
Manual 5	Guidelines for the manufacture and construction of hot mix asphalt
Manual 6	(Withdrawn)
Manual 7	SurperSurf – Economic warrants for surfacing roads
Manual 8	Guidelines for the safe and responsible handling of bituminous products
Manual 9	(Withdrawn)
Manual 10	Bituminous surfacing for low volume roads and temporary deviations
Manual 11	(Withdrawn)
Manual 12	Labour Absorptive methods in road construction using bituminous materials
Manual 13	LAMBs – The design and use of large aggregate mixes for bases
Manual 14	(Superseded by TG2)
Manual 15	(Withdrawn)
Manual 16	(Withdrawn)
Manual 17	Porous asphalt mixes: Design and use
Manual 18	Appropriate standards for the use of sand asphalt
Manual 19	Guidelines for the design, manufacture and construction of bitumen rubber asphalt wearing courses
Manual 20	Sealing of active cracks in road pavements
Manual 21	(Superseded by TG2)
Manual 22	Hot mix paving in adverse weather
Manual 23	Code of practice: Loading bitumen at refineries
Manual 24	User guide for the design of asphalt mixes (currently being developed)
Manual 25	Code of practice: Transportation, off-loading and storage of bitumen and bituminous products
Manual 26	Interim guidelines for primes and stone pre-coating fluids
Manual 27	Guidelines for thin hot mix asphalt wearing courses on residential streets
Manual 28	Best practice for the design and construction of slurry seals
Manual 29	Guide to the safe use of solvents in a bituminous products laboratory
Manual 30	A guide to the selection of bituminous binders for road construction
Manual 31	Guidelines for calibrating a binder distributor to ensure satisfactory performance
Manual 32	Best practice guideline and specification for warm mix asphalt
Manual 33	Design procedure for high modulus asphalt (EME)
Manual 34	(A) Guidelines to the transportation of bitumen and (B) Bitumen spill protocol (booklets)
Manual 35 / TRH8	Design and use of Asphalt in Road Pavements
Manual 36 / TRH21	Use of Reclaimed Asphalt in the Production of Asphalt
Manual 37	Sampling Methods for road construction materials (currently being developed)
Manual 38	A Health and Safety Guide for material testing laboratories in the road construction industry
Manual 39	Laboratory testing protocols for binders and asphalt
Manual 40	Design and construction of surfacing seals

TECHNICAL GUIDELINES

TG 1	The use of modified binders in road construction
TG 2	Bitumen stabilised materials
TG 3	Asphalt reinforcement for road condition

SABITA DVD SERIES

DVD 100	Test methods for bituminous products
DVD 200	Training guide for the construction and repair of bituminous surfacing by hand
DVD 300	Manufacture, paving and compaction of hot mix asphalt
DVD 410	The safe handling of bitumen
DVD 420	Treatment of bitumen burns
DVD 430	Working safely with bitumen
DVD 440	Firefighting in the bituminous products industry
DVD 450	Safe loading and off-loading of bitumen

ACKNOWLEDGEMENTS

Sabita acknowledges, with thanks, the time and effort given by the following contributors responsible for compiling this important guideline document for the industry:

Dave Collings	Loudon International
Arno Hefer	Rubicon Solutions
Kim Jenkins	Stellenbosch University
Fenella Johns	Rubicon Solutions

Other Contributors

Anton Ferreira	Lifeguard Safety Solutions
André Greyling	BVI Consulting Engineers
Joe Grobler	SMEC
Mike Hughes	WSP Group
Fritz Jooste	Rubicon Solutions/Lonrix
Gerrit Jordaan	Jordaan Professional Services
Pieter Myburgh	Consultant
Barry Pearce	Learning Matters etc
Dennis Rossmann	SANRAL
Wynand Steyn	University of Pretoria
Hugh Thompson	WSP Group
Wynand van Niekerk	BSM Laboratories

GLOSSARY OF TERMS

$\tau_{1/2}$	Half-life
AASHTO	American Association of State Highway and Transportation Officials
Active filler	Fillers that chemically alter the mix properties. This includes fillers such as lime, cement, fly ash, etc, but excludes natural fillers such as rock flour
Ambient temperature	Temperature of 23 °C ± 2 °C
BSM(s)	Bitumen Stabilised Material(s)
BSM-emulsion	Bitumen emulsion treated material
BSM-foam	Foamed bitumen treated material
CBR	California Bearing Ratio
COTO	Committee of Transport Officials
CS	Crushed stone
DE-G1 to DE-G10	Design equivalent G1 to G10 material classes
DEMAC	Design equivalent material class
ELTS	Effective long term stiffness. This is a relative indicator of the average long term in situ stiffness of a pavement layer
EMC	Equilibrium moisture content
ER	Expansion Ratio
EWC	Bitumen emulsion water content including water used for dilution as percentage of dry aggregate
Fluff point	Moisture content at which the “maximum bulk volume of loose mineral aggregate is attained”, after agitation or mixing
FMC	Field moisture content of aggregate
G1 to G10	Granular materials classes, see TRH4 for definitions
GS	Gravel soil
HSE	Health Safety and Environment
ICL	Initial consumption of lime
ITS _{DRY}	Indirect Tensile Strength test, 150 mm diameter specimens cured according to curing procedure
ITS _{WET}	Indirect Tensile Strength test, 150 mm diameter specimens cured then soaked for 24 hours at 25 °C.
Lime	Lime refers to hydrated road lime
Mastic	The mastic is the mix of fines and bitumen
maximum stiffness	The maximum stiffness a material can achieve depends on the material quality
MDD	Maximum dry density
ME	Mechanistic-Empirical
MESA	Million equivalent standard axles, 80 kN axles
mm	Millimetres
Mod. AASHTO	Modified AASHTO compaction, now MDD (Maximum dry density)
Modular Ratio	Ratio of a layer’s stiffness relative to the stiffness of the layer below.
MPa	megaPascals
N	Weinert’s N-value
NG	Natural gravel
OFC	Optimum fluids content
PI	Plasticity Index
PN	Pavement number
PTR	Pneumatic Tyred Roller
RA	Reclaimed asphalt
RBC	Residual bitumen content as percentage of dry aggregate
SSSC	Silt, silty sand, clay
UCS	Unconfined Compression Strength

CONTENTS

FOREWORD	ii
MANUALS PUBLISHED BY SABITA	iii
ACKNOWLEDGEMENTS	v
GLOSSARY OF TERMS	vi
LIST OF FIGURES.....	ix
LIST OF TABLES	x
CHAPTER 1. INTRODUCTION	1
1.1 WHAT ARE BITUMEN STABILISED MATERIALS?	1
1.2 PURPOSE OF THE GUIDELINE	3
1.3 LAYOUT OF THE GUIDELINE	3
CHAPTER 2. BITUMEN STABILISATION, USAGE AND DESIGN APPROACH.....	5
2.1 WHAT IS BITUMEN EMULSION AND FOAMED BITUMEN?	5
2.2 STABILISING WITH BITUMEN EMULSION	6
2.3 STABILISING WITH FOAMED BITUMEN.....	6
2.4 BEHAVIOUR OF BITUMEN STABILISED MATERIALS.....	7
2.5 BENEFITS OF BITUMEN STABILISATION	8
2.6 LIMITATIONS OF BITUMEN STABILISATION	9
2.7 MATERIALS SUITABLE FOR BITUMEN STABILISATION.....	10
2.8 WHERE ARE BSMS USED?.....	11
2.9 DESIGN APPROACH	13
2.10 DESIGN EQUIVALENT MATERIAL CLASSIFICATION APPROACH.....	13
2.11 HEALTH, SAFETY AND ENVIRONMENT	13
2.12 ALTERNATIVE BITUMINOUS BINDER TECHNOLOGIES.....	15
CHAPTER 3. PAVEMENT INVESTIGATION AND EVALUATION.....	16
3.1 IN SITU RECYCLING LIMITATIONS.....	17
3.2 APPROACH TO PAVEMENT INVESTIGATIONS	19
3.3 IDENTIFYING UNIFORM SECTIONS.....	19
3.4 DETAILED INVESTIGATIONS.....	22
3.5 EVALUATION / MATERIAL CLASSIFICATION	25
3.6 SUITABILITY FOR RECYCLING AND BITUMEN STABILISATION	29
3.7 PRELIMINARY PAVEMENT DESIGN (ESTIMATING THE RECYCLING DEPTH).....	29
3.8 ASSESSING VARIABILITY IN THE RECYCLED MATERIAL.....	30
3.9 STABILISATION MIX DESIGN FOR EACH UNIFORM MATERIAL.....	31
3.10 STRUCTURAL DESIGN VERIFICATION	31
3.11 DEFINE SPECIFIC DESIGN REQUIREMENTS.....	32
3.12 ALTERNATIVE DESIGNS AND ECONOMIC ANALYSES.....	33

CHAPTER 4. MIX DESIGN	35
4.1 MIX DESIGN CONSIDERATIONS	36
4.2 MIX CONSTITUENTS	37
4.3 MIX DESIGN PROCEDURE	46
CHAPTER 5: STRUCTURAL DESIGN.....	58
5.1 PAVEMENT NUMBER STRUCTURAL DESIGN METHOD	58
5.2 MECHANISTIC-EMPIRICAL DESIGN.....	62
5.3 APPROPRIATE SURFACINGS	66
5.4 ECONOMIC ANALYSES AND MAINTENANCE REQUIREMENTS	66
CHAPTER 6. CONSTRUCTION.....	68
6.1 IN SITU TREATMENT.....	69
6.2 IN SITU TREATMENT USING RECYCLERS.....	69
6.3 IN SITU TREATMENT USING CONVENTIONAL EQUIPMENT (BSM-EMULSION ONLY).....	87
6.4 IN PLANT TREATMENT.....	90
6.5 CURING AND TRAFFICKING	99
6.6 SURFACING.....	100
6.7 CONSTRUCTING TRIAL SECTIONS.....	101
APPENDIX A: DESIGN EQUIVALENT MATERIAL CLASSIFICATION SYSTEM.....	103
APPENDIX B: LABORATORY TESTS.....	129
APPENDIX C: STRUCTURAL DESIGN: PAVEMENT NUMBER GUIDELINES AND WORKED EXAMPLE	174
WITH PAVEMENT NUMBER AND MECHANISTIC-EMPIRICAL CRITERIA	174
APPENDIX D: QUALITY CONTROL	197

LIST OF FIGURES

FIGURE 1.1 BITUMEN “SPOT WELDS” BETWEEN AGGREGATE PARTICLES.....	2
FIGURE 1.2 CONCEPTUAL BEHAVIOUR OF PAVEMENT MATERIALS.....	2
FIGURE 2.1 MANUFACTURING PROCESS FOR BITUMEN EMULSION.....	5
FIGURE 2.2 PRODUCTION OF FOAMED BITUMEN.....	6
FIGURE 3.1 EXTENSIVELY PATCHED ROAD.....	16
FIGURE 3.2 THE IN SITU RECYCLING PROCESS.....	17
FIGURE 3.3 SEVERELY DISTRESSED ASPHALT.....	18
FIGURE 3.4 PAVEMENT INVESTIGATION AND DESIGN FLOW CHART FOR IN SITU RECYCLING WITH BSMS.....	20
FIGURE 3.5 CONSEQUENCE OF CHANGING THE SURFACE CROSS-FALL.....	21
FIGURE 3.6 EXAMPLE OF INTERPRETATION OF TEST RESULTS.....	27
FIGURE 3.7 EXAMPLE OF A REPRESENTATIVE PAVEMENT STRUCTURE.....	28
FIGURE 3.8 ESTIMATING THE DEPTH OF RECYCLING.....	30
FIGURE 3.9 MATERIAL IMPORT TO IMPROVE THE MIX.....	32
FIGURE 3.10 RECYCLING WHERE THE SURFACE IS OUT OF SHAPE.....	33
FIGURE 3.11 RECYCLING AFTER IMPORTING NEW MATERIAL.....	33
FIGURE 3.12 EXAMPLE: ALTERNATIVE REHABILITATION DESIGNS FOR THE SAME STRUCTURAL CAPACITY.....	34
FIGURE 4.1 OUTLINE OF MIX DESIGN.....	35
FIGURE 4.2 DETERMINATION OF FOAM CHARACTERISTICS: OPTIMUM WATER ADDITION TO HOT BITUMEN.....	43
FIGURE 4.3 SAMPLE AND PRELIMINARY TESTS FOR CHARACTERISATION.....	46
FIGURE 4.4 EXAMPLE OF BLENDING EXERCISE.....	47
FIGURE 4.5 GRADINGS FOR BSM-EMULSION, BSM-FOAM AND RA.....	48
FIGURE 4.6 SELECTION OF ACTIVE FILLER.....	52
FIGURE 4.7 OPTIMISATION OF BITUMEN CONTENT.....	55
FIGURE 4.8 SELECTION OF BITUMEN CONTENT FROM ITS _{DRY} AND ITS _{WET}	55
FIGURE 4.9 TRIAXIAL TESTING TO COMPLETE OVERALL BSM MIX DESIGN PROCEDURE.....	56
FIGURE 4.10 MOHR-COULOMB PLOT OF MONOTONIC TRIAXIAL RESULTS.....	56
FIGURE 4.11 EVALUATION OF RETAINED COHESION FROM TRIAXIAL TESTS.....	57
FIGURE 5.1 MINIMUM SURFACING THICKNESS FOR BSM PAVEMENTS.....	67
FIGURE 6.1 BSM CONSTRUCTION OPTIONS.....	68
FIGURE 6.2 CONSEQUENCE OF POOR SURFACE SHAPE.....	72
FIGURE 6.3 EXAMPLE OF A CUT PLAN FOR RECYCLING A 2-LANE ROAD IN HALF-WIDTHS.....	76
FIGURE 6.4 EXAMPLE OF THE SPRAYBAR SETTINGS FOR A WIRTGEN WR240.....	77
FIGURE 6.5 TYPICAL RECYCLING TRAIN FOR BITUMEN STABILISATION.....	80
FIGURE 6.6 CHECKING THE CUT DEPTH BY DIPPING.....	82
FIGURE 6.7 MIXED MATERIAL EXITING BEHIND THE RECYCLER.....	85
FIGURE 6.8 MIXING PLANT FOR TREATING MATERIAL WITH FOAMED BITUMEN.....	91
FIGURE 6.9 UNCOMPACTED STRIP OF MATERIAL ON THE CENTRE-LINE.....	97
FIGURE 6.10 PAVING THE SECOND HALF-WIDTH.....	97

LIST OF TABLES

TABLE 3.1	RELATIVE CONFIDENCE OF MATERIALS CLASSIFICATION AND RECOMMENDED APPLICATION	28
TABLE 3.2	EXAMPLE: LABORATORY RESULTS INDICATING MATERIAL VARIABILITY	31
TABLE 4.1	BREAKDOWN COEFFICIENT	39
TABLE 4.2	DURABILITY MILL INDEX, LIMIT FOR ROCKS AND SOILS	40
TABLE 4.3	CATEGORIES OF BITUMEN EMULSION FOR TREATMENT	41
TABLE 4.4	COMPATIBILITY OF BITUMEN EMULSION TYPE WITH AGGREGATE TYPE	41
TABLE 4.5	FOAMING CHARACTERISTIC LIMITS	42
TABLE 4.6	ROLE OF FLUIDS IN BSMS	44
TABLE 4.7	RECOMMENDED GRADING FOR BSM-FOAM AND BSM-EMULSION	48
TABLE 4.8	EXAMPLE OF RECONSTITUTING A REPRESENTATIVE SAMPLE	49
TABLE 4.9	SAMPLE SIZE REQUIREMENTS FOR MIX DESIGN TESTS	51
TABLE 4.10	BSM COMPONENT REQUIREMENTS FOR CLASSIFICATION	52
TABLE 4.11	INDIRECT TENSILE STRENGTH LIMITS FOR CLASSIFICATION	53
TABLE 4.12	GUIDELINES FOR ESTIMATING NOMINAL BITUMEN ADDITION	53
TABLE 4.13	EXAMPLE OF ACTIVE FILLER TYPE DETERMINATION	54
TABLE 4.14	BSM CLASSIFICATION LIMITS	57
TABLE 5.1	PN METHOD INPUT VALUES FOR BSMS	61
TABLE 5.2	RECOMMENDED RESILIENT MODULI AND MODULAR RATIOS FOR BSMS	63
TABLE 5.3	DEFAULT VALUES FOR THE BSM SHEAR PARAMETERS IN PRELIMINARY ME DESIGN	65
TABLE 5.4	TYPICAL FUTURE MAINTENANCE MEASURES FOR BSM BASE PAVEMENTS	67
TABLE 6.1	RECOMMENDED STATIC MASS OF THE PRIMARY ROLLER	74
TABLE 6.2	EXAMPLE OF THE DAILY DEMAND FOR BITUMEN AND ACTIVE FILLER	77
TABLE 6.3	EFFECT OF ADVANCE SPEED ON GRADING AND MIX QUALITY	81
TABLE 6.4	DILUTION OF BITUMEN EMULSION	89

CHAPTER 1. INTRODUCTION

Road pavements constructed using a bitumen stabilised material (BSM) in the base layer are durable and sustainable, meeting environmental directives for reducing energy consumption and emissions whilst elevating cost-effectivity by providing outstanding performance at nominal cost. BSMs incorporating either bitumen emulsion or foamed bitumen are suited to both the construction of new pavements and pavement rehabilitation using in-place recyclers and/or off site mixing plants. Conventional construction equipment can be used to stabilise with bitumen emulsion, providing the existing pavement is of reasonable quality. BSMs are also suitable for labour intensive construction.

Worldwide, the demand for road rehabilitation far exceeds the demand for new roads. In most countries, annual maintenance budgets are insufficient, resulting in an ever expanding backlog of rehabilitation requirements. This situation has seen the adoption of in place recycling as the preferred procedure for addressing the need for structural rehabilitation by recovering and reusing material in the existing pavement. Bitumen stabilisation enhances the properties of the recycled materials, providing service lives that meet conventional norms, normally at a lower cost and reducing the need for virgin aggregates.

This guideline covers the approach to investigation, material classification, design and construction of pavements using BSMs. To differentiate between bitumen emulsion and foamed bitumen treated materials, the terms BSM-emulsion and BSM-foam are used. Where there are differences in the approach to BSM-emulsion and BSM-foam, these are clearly highlighted.

1.1 WHAT ARE BITUMEN STABILISED MATERIALS?

BSMs are pavement materials that are treated with either bitumen emulsion or foamed bitumen. The materials commonly treated include granular materials, previously cement stabilised materials and reclaimed asphalt (RA). Where an existing pavement is recycled, old seals or asphalt surfacing layers are usually mixed with the underlying layer and treated to form a new base or subbase layer. In cases where the existing pavement carries heavy traffic, the recycled layer normally includes a higher proportion of RA due to the tendency of structural designs relying on asphalt for bearing capacity.

The quantities of residual bitumen in stabilisation do not typically exceed 2.5% (by mass) of the dry aggregate. In most situations, active filler in the form of cement or hydrated lime is also added to the mix. **Cement addition should never exceed 1%.** If more than 1% is added, the material should be considered a cement-treated material and the guidelines in TRH13 should be followed.

The addition of bitumen emulsion or foamed bitumen to produce a BSM results in an increase in material strength and a reduction in moisture susceptibility. The manner in which the bitumen is dispersed amongst the finer aggregate particles differs between the processes, as outlined below:

Bitumen emulsion. Similar to water, bitumen emulsion wets all particles when mixed with a material. Since the finer particles are responsible for the bulk of the surface area of the material, the emulsion effectively concentrates on these finer particles and the coarser particles receive very little coating (a “smattering”). In addition, there is a polar attraction between the emulsion and aggregate. This is a consequence of the charge applied by the emulsifying agent to the bitumen droplets in the emulsion, unless the charge is disrupted by an active filler.

Note: Emulsion treated materials commonly used for patching are not classed as BSMs. These materials are normally prepared using a good quality crushed stone, e.g. G2, and mixed in accordance with a recipe, e.g., 2% emulsion and 2% cement.

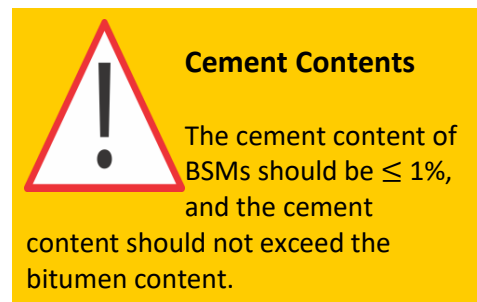

Foamed bitumen. Tiny bitumen splinters are created when foam bubbles burst on coming into contact with aggregate. These bitumen elements disperse exclusively amongst the finer particles when foamed bitumen is mixed with a granular material. In addition, bitumen has an exceptional affinity for active filler.

Bitumen dispersion in BSM-foam produces “spot welds” between the various particles when the material is compacted (when foamed bitumen is applied) and the bitumen breaks out of suspension (when bitumen emulsion is applied). This “spot welding” concept is illustrated in Figure 1.1.

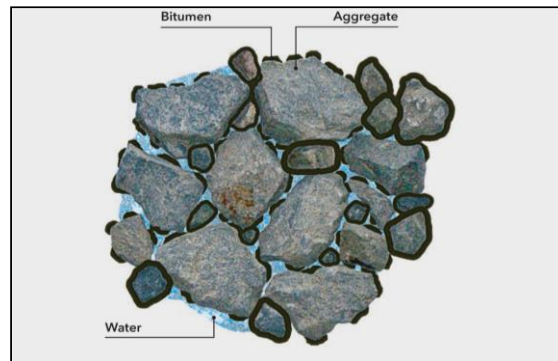

Figure 1.1 Bitumen “Spot Welds” between Aggregate Particles

This “non-continuous” binding of the individual aggregate particles makes BSMs different from all other pavement materials. The dispersed bitumen improves the shear strength of the material by significantly increasing the cohesion value whilst effecting little change to the angle of internal friction. A compacted layer of BSM will have a void content similar to that of a granular layer, not an asphalt. BSMs are therefore granular in nature and are treated as such during construction. The many benefits that accrue from using BSMs are discussed in Chapter 2.

The behaviour of BSMs, relative to other pavement materials is illustrated in Figure 1.2.

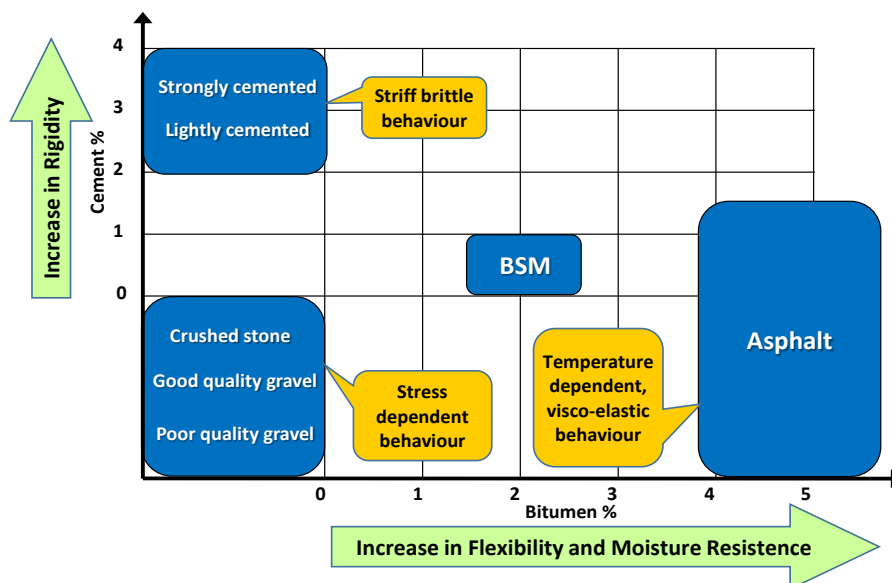

Figure 1.2 Conceptual Behaviour of Pavement Materials

Contrary to some misconceptions, the addition of foamed bitumen at ambient temperatures or small amounts of bitumen emulsion does not change the nature of the material so that it becomes cold-mix asphalt. BSMs remain granular in nature and are processed as such during construction. They are stress dependent and have been colloquially termed “granular material on steroids”. For this reason terminology such as “foamed asphalt” is not recommended for BSM-foam as it perpetuates the misinterpretation.

In a similar way the restriction of cement to a maximum 1% keeps the material from becoming rigid or cement stabilised which is different from the old “ETB” concepts, which include very low emulsion application rates i.e. less than 2% gross binder and cement contents above 1.5%.

The cement content of BSMs should be $\leq 1\%$, and the cement content should not exceed the bitumen content.

In this guideline, the terms “stabilise” and “treat” are used interchangeably. The differentiation between stabilisation and modification applies to cement and lime stabilisation exclusively and is not applicable to BSMs. For BSMs, the focus is on the behaviour of the final product, rather than the quantity of the constituents which make up the product.



BSM Behaviour

The addition of bitumen emulsion or foamed bitumen **does not transform the material to an asphalt like material.**

1.2 PURPOSE OF THE GUIDELINE

This 3rd Edition of the TG2 guideline supersedes the following manuals:

- Interim Technical Guideline: The Design and Use of Foamed Bitumen Treated Materials, TG2 (Asphalt Academy, 2002).
- Technical Guideline: Bitumen Stabilised Materials. A Guideline for the Design and Construction of Bitumen Emulsion and Foamed Bitumen Stabilised Materials. TG2. Second Edition, May 2009. (Asphalt Academy, 2009). ISBN 978-0-7988-5582-2.

For the Second Edition of TG2, the decision was taken to combine BSM-emulsion and BSM-foam in one document because of the many similarities between the materials. Time has shown that this approach was judicious as it has assisted in preventing the incorrect application of the technologies, while recognising scientific differences between BSM-emulsion and BSM-foam.

This 3rd Edition of the TG2 guideline updates the 2009 publication with developments in the technology. During the intervening period, thousands of kilometres of road pavements, ranging from low volume roads to heavily trafficked highways, have received BSM treatment. This has allowed the technology to be tried and tested under various support, climatic and traffic conditions which, in turn, has seen improvements made to the equipment used to construct BSM layers as well as methods for designing appropriate pavement structures. Significant research into the behaviour and performance of BSMs has been undertaken, focusing on mix design, classifying materials for design and structural design. Observations of in-service pavements have contributed to the knowledge base of BSM pavements. All this research has been incorporated into this guideline.

The purpose of this guideline is to provide a complete reference for project selection, treatment selection, material classification, mix design, structural design and construction requirements for projects utilising BSMs.

This guideline should however be used in conjunction with the South African Pavement Engineering Manual, which provides a road map for TG2 and other established guidelines, as outlined below:

- **TRH4:** Structural Design of Flexible Pavements for Interurban and Rural Roads, Draft 1996.
- **TRH12:** Flexible pavement rehabilitation investigation and design, Draft 1997.
- **TRH14:** Guidelines for road construction materials, 1985.
- Job Creation, Skills Development and Empowerment in Road Construction, Rehabilitation and Maintenance, GDPTRW, 2008.
- Manuals published by manufacturers of the machinery used to construct BSM layers.

1.3 LAYOUT OF THE GUIDELINE

This guideline contains six chapters, a bibliography and four appendices:

- **Chapter 2** explains bitumen stabilisation, where BSMs are used, the benefits and the approach to design.

- **Chapter 3** explains the investigations and evaluations that are essential for pavement rehabilitation projects where the focus is on in situ recycling, and provides an update to material classification according to “design equivalent” (DEMAC) classes.
- **Chapter 4** deals with the updated mix design procedure for BSMs. BSMs are now classified in one of two classes, BSM1 or BSM2, both largely influenced by the quality of the parent material. This change was largely influenced by the application of BSM technology on major highways where more stringent requirements in terms of material selection and mix design are required.
- **Chapter 5** covers the structural design of pavements with BSM layers and includes both an updated version of the Pavement Number (PN) design method as well as new criteria for a mechanistic-empirical design based on the deviator stress ratio and other key performance parameters.
- **Chapter 6** deals with the construction of pavement layers using BSMs, both recycled in situ and mixed in plant. In recognition of the different machines that are currently utilised for constructing BSM layers and the respective manufacturer’s extensive literature detailing their application, this chapter includes only the major aspects that need consideration.
- **Appendix A** gives the background and complete details of the Materials Classification System.
- **Appendix B** provides a suite of laboratory test methods specifically compiled for BSMs.
- **Appendix C** provides guidance and worked examples for using the Pavement Number design method and the Mechanistic Empirical structural design method using the new Stellenbosch BSM Transfer Function.
- **Appendix D** summarises the quality control tests applicable to layers constructed with BSMs.

CHAPTER 2. BITUMEN STABILISATION, USAGE AND DESIGN APPROACH

This chapter covers much of the background information for the subsequent chapters. A description of bitumen emulsion and foamed bitumen is included and the behaviour of BSMs explained. Projects suitable for bitumen stabilisation are reviewed along with the benefits of using BSMs and where they are most appropriately used. Finally, the approach for mix and structural design is introduced.

2.1 WHAT IS BITUMEN EMULSION AND FOAMED BITUMEN?

Both bitumen emulsion and foamed bitumen technologies are methods of reducing the viscosity of bitumen, allowing it to be mixed with cold moist material. They are, however, produced using completely different methods.

2.1.1 Bitumen Emulsion

Bitumen emulsion is a suspension of tiny bitumen droplets in water. The bitumen is held in suspension by an emulsifier, a surface active compound that adheres to each individual droplet, providing it with a charge. The emulsifying agent used determines the charge of the bitumen droplets in the emulsion:

- Cationic emulsions are positively charged.
- Anionic emulsions are negatively charged.

The manufacturing process for bitumen emulsion, illustrated in Figure 2.1, is undertaken in a plant that blends the different ingredients together in a colloidal mill. Bitumen emulsion can have a shelf life of several months, provided the manufacturer’s storage guidelines are strictly followed.

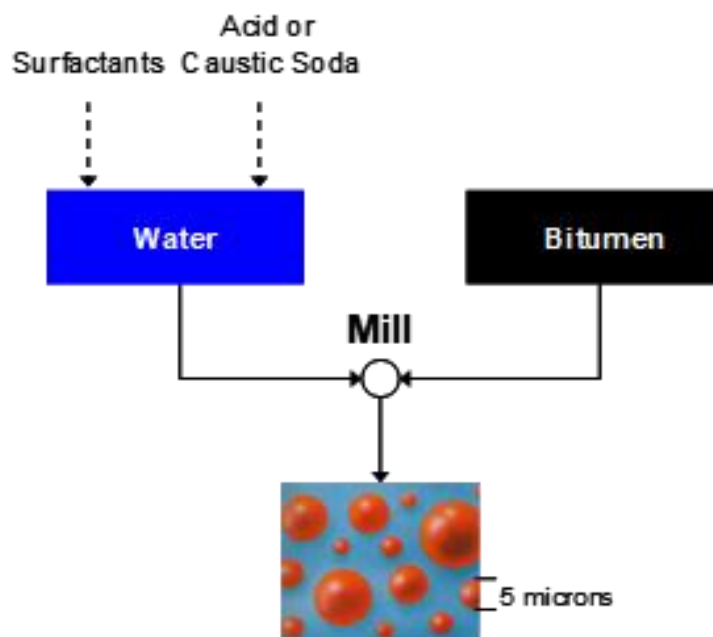

Figure 2.1 Manufacturing Process for Bitumen Emulsion

2.1.2 Foamed Bitumen

Foamed bitumen is produced by injecting a small amount of water into hot (> 160°C) bitumen. The water instantly changes state from liquid to vapour, expanding some 1500 times in volume at sea level, producing a mass of

bubbles (foam) that are thin films of bitumen surrounding the water vapour (steam). The foam is unstable and collapses in less than a minute.

The expansion chamber developed by Mobil in the 1960s is still the most commonly used system for producing foamed bitumen. Expansion chambers are thick-walled steel tubes, approximately 50 mm in depth and diameter, into which hot bitumen, water and air are injected under pressure (> 3 bar). The process is shown in Figure 2.2.

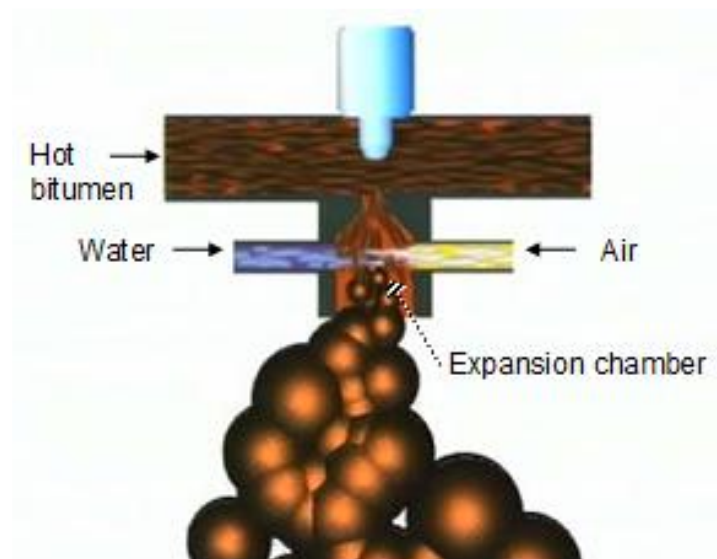

Figure 2.2 Production of Foamed Bitumen

2.2 STABILISING WITH BITUMEN EMULSION

When mixed with aggregate at ambient temperatures, the relatively low viscosity of the emulsion allows wetting of all the particles, focusing on the smaller fractions since that is where the majority of the surface area (and charge concentration) is located. The approximate surface area of 1 kilogram of different particle sizes is:

- 20 mm stone: 0.1 m²
- 5 mm stone: 0.4 m²
- 0.075 mm dust: 34.0 m²

The moisture and type of aggregate being mixed play an important role in dispersing the bitumen emulsion and preventing a premature “break” (flocculation and coalescence of the bitumen droplets, resulting in separation of the bitumen from the water) during mixing.

Once mixed, the bitumen emulsion needs to break to allow the bitumen to act as a “glue” (binding agent). However, since the bitumen emulsion also acts as a lubricating agent, the break should occur only after the material has been fully compacted. The treated material will have a “speckled” appearance due to the concentration of bitumen on the finer particles.

Bitumen emulsions are discussed in more detail in Chapter 4.

2.3 STABILISING WITH FOAMED BITUMEN

To produce a BSM-foam, the bitumen is foamed in expansion chambers that are fitted to machines on site that instantly mixes it with aggregate while still in its foamed state. The greater the volume of the foam, the thinner the film of bitumen surrounding the steam and the better the resulting dispersion of bitumen amongst the aggregate particles.

During the mixing process, the bitumen bubbles burst, producing tiny bitumen splinters that disperse throughout the aggregate by adhering only to the finer particles (fine sand and smaller). Where the aggregate includes

reclaimed asphalt (RA), the bitumen splinters are able to attach themselves as spots to the aged bitumen on coarser particles.

The temperature and moisture content of the material prior to the addition of foamed bitumen plays an important role in dispersing the bitumen. On compaction, the individual bitumen splinters are physically pressed against the aggregate particles, resulting in localised non-continuous bonds (“spot welding”).

Foamed bitumen is discussed in more detail in Chapter 4.

2.4 BEHAVIOUR OF BITUMEN STABILISED MATERIALS

The behaviour of BSM is similar to that of unbound granular materials, but with significantly increased levels of cohesion and reduced moisture sensitivity. Unlike hot-mix asphalt, BSM is not black in appearance and does not have a sticky feel. The larger aggregate particles in a BSM are not coated with bitumen. The bitumen disperses only amongst the finest particles, resulting in a bitumen-rich mortar between the coarser particles. There is a slight darkening in the colour of the material after treatment. Typically, small amounts of active filler (cement or hydrated lime) are added to the mix in conjunction with the bitumen emulsion or foamed bitumen. Active filler assists in dispersing the bitumen in the mortar fraction. Hydration by the active filler reduces the moisture content and can assist in resisting early ravelling under traffic. However, a gradual gain in bond strength between bitumen and aggregate, enhanced by active filler, provides longer term resistance to moisture damage. No distinction is made in these guidelines between the behaviour and performance of BSM-foam and BSM-emulsion. This assumption is based on numerous observations of in-service pavements.

The main features and behaviour characteristics of BSMs are:

- BSM exhibits a significant increase in cohesion in comparison to the untreated material. The friction angle of the treated material is typically similar to the untreated material.
- BSM acquires flexural strength and stiffness as a result of the visco-elastic properties of the dispersed bitumen. The individual bitumen splinters are not linked and the coarser aggregate particles remain uncoated. Consequently, BSM retains the granular characteristics of the parent material. The stiffness of BSM is, therefore, stress dependent and these materials are not prone to fatigue cracking.
- The bitumen is dispersed mainly amongst the finer particles, thereby encapsulating and immobilising them. This reduces the moisture sensitivity and improves the durability of the treated material. Since the fines are bound, the tendency for the BSM to pump fines when subjected to load under saturated conditions is significantly reduced.
- Similar to unbound granular materials, the stiffness of BSM in a pavement layer is dependent on:
 - The inherent quality of the untreated material.
 - The density of the material in the layer (a function of packing).
 - The quantities of binder and active filler added, and their dispersion throughout the mixed material.
 - The local climate, particularly ambient temperature and rainfall.
 - The stiffness of the underlying support.
 - However, it is important to appreciate that it is the large increase in cohesion and the small change in the angle of internal friction that allows the material to sustain a higher level of stiffness than the parent material when a load is applied.
- The primary mode of failure of BSMs is permanent deformation.
- The behaviour of BSMs varies significantly depending on the quality of the untreated material and the amount of bitumen and active filler applied. When excessive cement is applied, the material behaves more like cement treated material and the benefit of adding bitumen is debateable. For this reason cement addition is limited to 1% (by mass). In addition, when the untreated material includes a siliceous material, the potential for a pozzolanic reaction with the active filler needs to be checked.

BSM Behaviour

i

The behaviour of BSMs is similar to that of unbound granular materials, but with improved cohesive strength and reduced moisture sensitivity.

It is important to understand that the shear strength of a BSM can be compromised by:

- **The addition of excessive amounts of active filler.** Adding more than 1% cement runs the risk of transforming the material from one that is flexible to one that is brittle. The cohesive strength of such brittle material will dominate, reducing significantly once fracture occurs. This is likely to be associated with cracking and deformation, resulting in a material consisting of large fractured clumps with compromised shear resistance and stiffness.
- **Treating poorly graded or non-durable materials.** For example, soft weathered natural gravel or material with excessive fines. These materials have a low angle of internal friction. Inexperienced designers may be tempted to compensate for such a situation through the addition of higher amounts of cement. Such treatment will produce a brittle bound material that is highly susceptible to shrinkage, crushing and fatigue cracking.
- **Compatibility between the aggregate and active filler.** The potential for a pozzolanic reaction between the aggregate and lime or cement needs consideration. For example, adding lime to quartzitic sandstone may lead to unwanted cementation.

BSMs are clearly very different to asphalt and cement treated materials in terms of behaviour and performance. In addition, they should not be confused with cold asphalt mixes manufactured with cut-back bitumen.

2.5 BENEFITS OF BITUMEN STABILISATION

The primary benefits of using BSMs are:

- **Strength.** The increase in strength associated with bitumen stabilisation allows a BSM to replace alternative high-quality materials in the upper pavement. For example, a G2 quality material treated with either bitumen emulsion or foamed bitumen can be used in place of an asphalt base, offering significant cost savings.
- **Durability.** Improved resistance to moisture damage due to the finer particles being encapsulated in bitumen and, therefore, immobilised.
- **Material quality.** Lower quality aggregates, for example, G5, can often be successfully used as a base layer.
- **Stockpiling.** BSMs can be produced in bulk and stockpiled (for limited periods) close to the point of application, to be spread and compacted at a later stage. This provides flexibility in the construction process. (Care must be exercised when stockpiling BSM-emulsion to prevent the emulsion draining from the aggregate.)
- **Grading.** BSM-emulsion mixes may be produced from materials with a low fines content.
- **Distress mode.** The failure condition of a BSM is permanent deformation. This implies that the pavement will require far less effort to rehabilitate when the terminal condition is reached compared with a material that fails due to full-depth cracking.
- **Temperature susceptibility.** Unlike hot mix asphalt, BSMs are relatively thermally insensitive. This is because the bitumen phase is not continuous throughout the mix.
- **Early trafficking.** Material treated with foamed bitumen achieves a significant increase in cohesive strength as soon as it is compacted. This provides the new layer with sufficient structural strength to withstand traffic loads immediately after construction, although protection from the ravelling action of tyres is required.

In addition, on pavement rehabilitation projects where the material in the existing pavement is recycled in situ with bitumen, the following benefits accrue:

- Unlike asphalt, BSMs are not overly sensitive materials and small variations in both the amount of bitumen added as well as the properties of the untreated material will not significantly change the strength achieved through treatment. Random variability in the recycled material is, therefore, less critical than in asphalt.
- Traffic disruption and time delays are minimised by working in half widths and opening to traffic soon after completion, especially when stabilising with foamed bitumen. The construction and maintenance of detours can, therefore, be avoided.

- Pavements showing a wide range of distress types can be effectively rehabilitated.
- The process significantly reduces the volume of heavy construction traffic that damages newly-constructed layers and adjacent service roads.
- The in situ recycling process also offers environmental advantages with conservation of natural aggregates and a reduction in material wastage, noise, exhaust and dust emissions. Where a layer of BSM can be substituted for an asphalt base, energy savings accrue through reduced heating and haulage between the asphalt plant and paver.

The use of BSMs normally results in significant cost and time savings on a project. However, the overriding consideration in the selection of projects for bitumen stabilisation is the estimated cost-benefit ratio. A full economic analysis should be carried out taking into account the initial construction cost, ongoing maintenance costs, the road user costs and the cost of rehabilitation and salvage at the end of the service life. The environmental benefits in terms of energy savings and preservation of natural resources are often difficult to quantify, but should also be considered.

i **Benefits of Recycling with BSMs**

- **Environmentally friendly process.**
- **Can be trafficked soon after compaction.**
- **Traffic disruption minimized.**
- **Significantly reduces heavy construction traffic.**

2.6 LIMITATIONS OF BITUMEN STABILISATION

The following concerns need to be addressed when considering the use of BSM on a project:

- **Economics.** Bitumen stabilisation adds significant cost to a project due to the price of active filler and bitumen, together with the related transport costs. Where sources of alternative construction materials are close by (quarries), the cost of treating with bitumen compared to other pavement solutions may preclude this option, especially for lower category roads.
- **Design expertise.** BSMs behave differently from other pavement materials and are not always well understood. One of the driving forces behind these guidelines is to provide design engineers with the tools needed to consider BSMs as an option in a pavement structure.
- **Construction expertise.** Bitumen stabilisation may be compared with other construction operations that require attention to detail, for example, asphalt manufacture and paving. Operators and supervisors need specialist training on both the equipment and the application of such equipment. Much of the required expertise comes with time since many control checks are visual.
- **Material variability.** On in situ recycling projects, other limitations relating to variability of the in situ materials are often encountered. However, such limitations apply to all in situ recycling projects and are not specific to bitumen stabilisation. The key to solving such variability problems lies with the design engineer and the attention to detail shown during the investigation, design and construction phases. This subject is discussed in Chapter 3.

2.6.1 Limitations Specific to Bitumen Emulsion

- **Moisture content of the untreated material.** Dry material cannot be mixed with bitumen emulsion. To avoid a premature break, sufficient moisture must be present in the aggregate to facilitate the dispersion of the added fluid. However, if the in situ moisture content is too high, adding bitumen emulsion can result in the total fluid content exceeding the optimum required for compaction. This will prevent the mixed material from being compacted to the required target density.
- **Bitumen emulsion stability.** The bitumen emulsion selected for use on a recycling project must be sufficiently stable to tolerate the pressure exerted by pumping and applying through a spraybar. Once the material has been mixed and compacted, a quick break is required to allow the material to gain strength. To ensure that the bitumen emulsion breaks within a reasonable time period, the formulation is critical
- **Bitumen emulsion formulation.** The mixing process requires the application of a stable class of emulsion, for example, slow set cationic emulsion (CSS60) or a stable grade anionic emulsion (SS60). The use of an

incorrect class of emulsion has caused problems on some projects. Premature breaking (flash set) of an unstable bitumen emulsion, for example, rapid set (CRS) emulsion, can damage the application system and/or prevent mixing by clogging up the mixing chamber on a recycler. Where the bitumen emulsion is too stable or incompatible with the material, it may take many months (or even years) to break.

- **Material temperature.** If the temperature of the material to be mixed is too low, bitumen emulsion is likely to disperse poorly. In general, stabilising with bitumen emulsion is not recommended when the temperature of the material being treated is below 10°C.

2.6.2 Limitations Specific to Foamed Bitumen

- **Material grading.** Foamed bitumen requires sufficient fine particles to be present in the material to facilitate the dispersion of the bitumen. Where the material is deficient in fines, a poor mix characterised by many bitumen-rich lumps, known as “stringers”, will be produced. Such poor bitumen dispersion will not provide the required increase in cohesion, nor will it reduce moisture sensitivity. For this reason, the minimum recommended fines content (percentage passing the 0.075 mm sieve) is 4%. This requirement may be reduced by the inclusion of RA in the mix since the individual RA particles are coated in aged bitumen that provide a surface onto which the bitumen splinters can adhere.
- **Material temperature.** Foamed bitumen will not disperse if the temperature of the material is too low for the type of bitumen that is foamed. In general, foamed bitumen is not recommended when the temperature of the material being treated is below 15°C. However, when a low-viscosity bitumen is foamed, for example, Pen > 150, material at lower temperatures has been successfully treated.
- **Moisture content.** The moisture content of the material being treated plays a major role in dispersing the bitumen. The ideal moisture content at the time of mixing is the “fluff point” of the material which is the moisture content at which the material achieves maximum volume. This is normally between 65% and 75% of OMC. Poor bitumen dispersion occurs when the material is too wet (the fines are “swimming”), or too dry (insufficient moisture for the bitumen splinters to heat and adhere to the fines), resulting in many stringers.
- **Foaming system.** Foamed bitumen requires specialist equipment that has been properly engineered. The two liquids (water and hot bitumen) used to create the foam are not compatible: water does not exist in its liquid state above 100°C and the grade of bitumen normally used for foamed bitumen treatment does not flow at such low temperatures. Unless the system is designed with positive measures to address this incompatibility, system blockages are inevitable. The foamed bitumen system must, therefore, be properly designed and engineered to avoid blockages. Premature failures have been experienced on some projects due to the use of poorly engineered systems incapable of producing a uniform and consistent supply of foamed bitumen.

2.7 MATERIALS SUITABLE FOR BITUMEN STABILISATION

Various types of material varying in quality from G1 to G5 can be stabilised with bitumen emulsion or foamed bitumen. Materials reclaimed from the upper horizon of existing road pavements generally fall within this quality range and can, therefore, be treated either in situ or in plant.

Examples of materials that are usually treated with bitumen are:

- Crushed stone of all rock types, G1 to G5.
- Previously untreated G4- and G5-quality natural gravels derived from andesite, basalt, chert, diabase, dolerite, dolomite, granite, laterite/ferricrete, limestone, norite, quartz, and sandstone. Whilst calccrete gravels can be successfully treated with bitumen emulsion, experience has shown that these materials are not suitable for treating with foamed bitumen.
- Reclaimed asphalt (RA) material, usually blended with an underlying crushed stone layer or a gravel layer.



- Reclaimed pavement layers comprised of crushed stone and/or gravel that were previously stabilised with cement.

Marginal materials, G6 or poorer quality, are generally not suitable for stabilising with bitumen. However, for low-volume roads where no other materials are readily available for construction, experienced practitioners may be able to consider their use.

For new construction or when rehabilitating existing pavements, the quality of material that is to be stabilised is dictated by the specific requirements for the BSM layer. The proposed material must always be tested for compliance by an accredited roads laboratory.

2.8 WHERE ARE BSMS USED?

As described above, bitumen stabilisation improves the shear strength of a material and significantly reduces moisture susceptibility. These benefits are, however, costly and BSMS are, therefore, best suited to upper pavement layers where stresses from applied loads are highest and moisture ingress due to surfacing defects are most likely to occur.

BSMs are mainly used on pavement rehabilitation projects where distress in the existing pavement structure is confined to the upper layers. This scenario is common where the surfacing layer has aged and cracked, allowing water to enter the pavement and cause moisture-activated distress in the underlying granular materials. Such pavements are ideal for in situ recycling and the bitumen is added to restore or improve the structural integrity before a thin surfacing layer is applied, such as asphalt or chip seal, depending on the traffic demands. Thus, most BSM projects carried out over the last two decades have been concerned with pavement rehabilitation and upgrading (strengthening and/or widening) where the in situ material is recycled.

Due mainly to escalating costs, treating good quality material (processed RA and/or graded crushed stone) with bitumen in a specialised plant is becoming increasingly popular in providing a durable, flexible and cost-effective base with reduced susceptibility to the effects of moisture.

Some of the more important factors that influence the suitability of BSMS on a particular project are discussed below.

2.8.1 Construction Method

BSMs can be constructed in several ways and the choice of which is best suited to a particular application is influenced by many factors, of which the major ones are:

- **Size of the project.** The rehabilitation of a major highway demands a different approach from that used to rehabilitate a lightly trafficked residential street.
- **The type of work to be undertaken.** Rehabilitation by reusing the material in the existing pavement is approached differently from a project that calls for a new lane to be added to an existing carriageway using virgin aggregates stabilised with bitumen.
- **Geographic and environmental considerations.** The overall approach to projects located in mountainous regions with high seasonal rainfall, sub-zero temperatures, steep gradients and low geometric standards is different from a project located in a flat, arid region.
- **Locality.** The haulage costs and practicalities encountered in supplying remote sites with a continuous supply of bitumen stabilising agents often rule out the use of BSMS. In addition, bitumen emulsion is not readily available in some regions.
- **Other factors.** Some project specifications demand that a certain construction method must be applied, for example, labour-intensive.

Treating a material with bitumen emulsion or foamed bitumen can be achieved in plant by feeding the material components through a mixer, or in situ using a recycler. Where the material in an existing pavement is suitable for recycling, in plant treatment is generally more expensive, primarily due to double handling and transport

costs. However, both in plant and in situ treatment have their place in the construction industry and the method adopted on a specific project is influenced by several factors, the most important being:

- **Type of construction.** Mixing in plant is normally considered for new roads, upgrading projects that require additional structural layers and for labour-intensive construction. It is also the preferred method for treating material for pavements that carry high volumes of traffic and heavy loads, primarily because the mix ingredients can be rigorously controlled.
- **Rehabilitation and upgrading projects.** Where material recycled from the upper horizon of an existing pavement is to be treated with bitumen, the variability and/or condition of the in situ material will normally dictate whether a process of selection and/or pretreatment is warranted, for example, breaking up lumps of RA. Such issues may rule out in situ treatment.
- **Traffic accommodation.** Specific traffic accommodation requirements may influence the preferred construction method to be adopted on a particular project.

Until the mid-1990s, in situ treatment with bitumen emulsion was undertaken using conventional construction equipment, such as motor graders, disc ploughs and rotovators. Although purpose-built recycling machines and the increased popularity of foamed bitumen have generally replaced such conventional equipment, these remain an option on smaller BSM-emulsion projects where the cost of establishing a large recycling machine may not be justified.

However, the quality limitations of using conventional equipment versus an in situ recycler must be considered when selecting the construction method.

2.8.2 In Situ versus In Plant Treatment

In situ treatment saw a significant increase in popularity during the 1990s due to the advent of powerful recycling machines, purpose-built to do the work more efficiently and at a reduced cost. In addition, these machines introduced the capability of constructing thick monolithic stabilised layers, thereby increasing their structural contribution and allowing engineers to design more cost-effective pavements.

As a consequence of the deteriorating state of road pavements worldwide, coupled with the huge financial investment therein, the need for rehabilitation of existing pavements far exceeds the demand for new roads. This situation has driven the adoption of in situ recycling as a preferred procedure for addressing the enormous rehabilitation backlog.

However, mixing in plant is an option that should always be considered, particularly where new layers of BSMs are to be constructed from virgin materials and/or a blend of virgin and recycled materials from stockpile. The main benefits that accrue from in plant mixing compared to in situ treatment are:

- **Control of input materials.** In situ recycling allows little control over the variability in the material encountered in the existing pavement. With plant mixing, the required end-product can be obtained by blending different materials, both virgin aggregates and recycled material. Input materials can be stockpiled and tested prior to mixing and the input proportions changed as required.
- **Quality of mixing.** Pugmill mixers used for in plant mixing are renowned for their ability to produce uniformly mixed material. Settings can be changed to vary the retention time in the mixer, thereby improving the quality of the mix.

2.8.3 Stockpiling Plant Mixed Material

BSM-emulsion is not recommended for stockpiling because the bitumen emulsion tends to drain from the aggregate and, if exposed to rain, can be washed out. The aggregates should rather be pre-blended and held in stockpile before being mixed and used immediately. Once the emulsion in stockpiled material has broken, the material becomes difficult to spread and compact.



BSM-foam may be placed in stockpile and used when required, thereby removing the inter-dependency between the mixing process and constructing the new layer. Stockpile life (the length of time that mixed material can remain in stockpile without losing potential strength) is primarily a function of moisture content and the type of active filler added to the mix. BSM-foam may be kept in stockpile for several days provided:

- Hydrated lime is used as an active filler (cement embodied in a moist material will hydrate).
- The moisture content of the material is maintained at approximately the optimum moisture content (OMC). This can be achieved by “sheeting” the entire stockpile with an impervious blanket. Such a sheet also protects against oxidation of the bitumen near the surface of the stockpile.
- The material in stockpile remains in an un-compacted state. The height of stockpile is limited to the maximum reach of the conveyor or loader used to place the material in stockpile. Vehicles must not be allowed to drive on the material in the stockpile.
- Samples of the material in stockpile are taken at regular intervals (e.g. daily) and ITS specimens manufactured to monitor any loss of strength. If the results show that the material will not meet the classification requirements (e.g. BSM1 or BSM2) then the stockpile must be rejected.

2.9 DESIGN APPROACH

The design sequence followed for pavements that incorporate BSM is essentially the same as that for all other pavement structures. It begins by determining the structural capacity requirement (design traffic), materials available for construction, the existing pavement structure for rehabilitation projects and environmental factors, such as climate. Site investigations and laboratory tests are carried out to classify the different materials, including the material that will be stabilised with bitumen.

Additional investigations and tests are required for rehabilitation projects where in situ recycling of the existing pavement is envisaged. These are explained in Chapter 3. A preliminary pavement design is necessary to estimate the required depth of recycling that normally dictates the final BSM layer thickness. This determines the material to be included in the recycling horizon and further laboratory tests are carried on this material.

Where the material to be stabilised with bitumen is found to be suitable, the mix design procedure described in Chapter 4 is followed to determine the shear properties and BSM classification achieved by treating with an appropriate active filler and the optimum application rate of bitumen stabilising agent. The structural design procedure explained in Chapter 5 then follows. If the result indicates that the initial estimate of the recycling depth was incorrect, the entire process needs to be repeated using a revised depth of recycling and BSM layer thickness. Once an appropriate design has been determined, an economic analysis is carried out for the recycling option and for alternative rehabilitation designs.

2.10 DESIGN EQUIVALENT MATERIAL CLASSIFICATION APPROACH

The objective of the material classification method introduced in Chapters 3, and explained in detail in Appendix A, is to provide a reliable, rational and consistent indication of the appropriate material class based on all available data. The method attempts to move away from the “yes/no” type of classification where one test can result in a material being classified in a higher or lower class than what its behaviour suggests. The method determines the certainty of a material belonging to a specific material class. These material classes are termed “Design Equivalent Material Class”. A DE-class denotes a material that exhibits shear strength, stiffness and flexibility properties similar to newly constructed materials of the same class.

2.11 HEALTH, SAFETY AND ENVIRONMENT

The general HSE hazards, potential consequences and control measures for bitumen and bituminous products are well documented in various Sabita publications and are not repeated here. It is however considered prudent that at least a basic overview of BSM specific HSE aspects are briefly discussed in this document. For detailed information on bitumen HSE consult the following Sabita publications:

Manual 8:	Guidelines for the safe and responsible handling of bituminous products;
Manual 25:	Code of Practice: Transportation, off-loading and storage of bitumen, bituminous products and asphalt in transit;
Manual 34 (A & B):	Guideline to legislation on the transportation of bitumen; and Bitumen spill protocol;
DVD410	The safe handling of bitumen;
DVD420	Treatment of bitumen burns;
DVD430	Working safely with bitumen;
DVD440	Fire-fighting in the bituminous industry;
DVD450	Safe loading and off-loading of Bitumen;
Best Practice Guide:	Operating best practice for temporary asphalt plants.

2.11.1 HSE Considerations for the Manufacture and Use of Bitumen Stabilised Materials

BSM-Emulsion

Compared to normal paving grade bitumen, bitumen emulsion is considered to be non-hazardous. This is based on the premise that emulsion is handled at a much lower temperature and that the bitumen is dispersed in water. At low to moderate operating temperatures bitumen emulsions do not produce any significant vapour or fumes that could be harmful if inhaled by humans.

Emulsions will not burn under normal circumstances. However, under severe fire conditions the water may evaporate completely and the residual bitumen could ignite.

Bitumen emulsions are usually handled at ambient temperature; however some high bitumen content emulsions is handled at elevated temperatures (40 °C to 80 °C) and manufacturers specify that emulsions are applied at a temperature of at least 60 °C. Even at these moderate temperatures emulsions can cause burns to the human body and operators must exercise due care and wear appropriate personal protective clothing when handling hot emulsions.

Emulsions pose no, or very limited, threat to the environment. However the reality is that ALL spills must be cleaned up and certain characteristics of emulsions can prolong recovery efforts and unnecessarily escalate overall remediation costs:

- Because of its lower viscosity and greater fluidity emulsions are more likely to rapidly spread and affect a larger area than other bitumen; and
- Emulsions could also migrate more rapidly from a land spill site into adjacent or nearby water environments. Trials conducted in the UK (in sea water) suggest that emulsion spills into water “do represent a serious challenge for oil spill response”.

BSM-Foam

Mixing water and hot bitumen is a definite ‘*taboo*’ in general bitumen operations. However, for BSM-foam it is an imperative. For the manufacture of good quality foamed bitumen the bitumen temperature must be above 160 °C to provide sufficient heat energy for the water to change state and create the foam. The normal bitumen temperature for foaming is 175 °C.

The very hot temperatures at which BSM-foam is handled could result in severe burns to the body which could be fatal. Personnel involved in BSM-foam handling must be made aware of the threats and potential consequences and specific control measures associated with hot bitumen. Appropriate personal protective equipment (PPE) and clothing must be available and management must ensure that operators wear PPE when handling BSM-foam.

Bitumen burns require special treatment and medical response personnel should be made aware of the correct treatment options. (Refer to the Sabita Bitumen Burns Card for more information on specific treatment of bitumen burns.)

Combining the water and additive (which are at ambient temperature) with the bitumen (which could be at 180 °C) results in a violent reaction when the mixture expands rapidly. During this foaming and expansion phase

the process equipment is placed under tremendous pressure and therefore bitumen foam manufacturing and application equipment should be purpose designed and approved by a competent person.

2.12 ALTERNATIVE BITUMINOUS BINDER TECHNOLOGIES

This TG2 guideline has been developed in support of bitumen stabilisation technology which generates flexibility and durability in pavement materials, primarily through bitumen addition. What is not covered in TG2, however, are the emerging technologies for alternative treatment methods for pavement materials. Bitumen emulsion is often used as a carrier of additives, e.g., organo-silane, that introduces a small amount of bitumen to the material. Many of the compounds used in these alternative methods of performance enhancement fall under the “nano-technology” banner. Given the broad range of functional groupings that are included in this general area of application, it would be inappropriate to single out individual products or compounds that use bitumen emulsion as a carrier. Suffice it to state that the benefits of these treatment methods include anti-stripping properties, compaction enhancement, dissociation of clayey minerals and development of hydrophobic material characteristics, amongst others.

It should be recognised that alternative technologies may require detailed chemical analysis of the material to be treated, which is not congruent with the TG2 mix design approach in this guideline. It is anticipated that guidelines for the preparation and application of these “nano-additives” will be developed in due course. Further information is available from publications, e.g. CAPSA 2019 and other sources.

CHAPTER 3. PAVEMENT INVESTIGATION AND EVALUATION

Pavements that need rehabilitation generally have long service lives and have usually received several maintenance measures. Since such maintenance measures are normally applied to the top of the pavement, for example, patching, overlays and reseals, the material in the upper horizon is seldom uniform. Figure 3.1 shows a typical example of such a road where a portion of the right lane was previously recycled with cement and numerous patches applied over time.



Figure 3.1 Extensively Patched Road

In some cases, old roads were widened to accommodate increased traffic volumes. New lanes added to existing carriageways will seldom have the same structure as the original pavement. Increased structural capacity requirements, advances in technology and the utilisation of materials from alternative sources invariably ensures that the new pavement structure is different from the old.

Variability of both the structural composition and the type and quality of the material in existing pavement layers must, therefore, be anticipated. Understanding such variability is the primary challenge for designers of rehabilitation projects, especially where the material in the upper horizon of the existing pavement is to be recovered and immediately reused by in situ recycling.

The economic benefits that accrue from in situ recycling, as explained in Chapter 1, have made this process the preferred method for rehabilitating distressed pavements. The upper 150 to 350 mm horizon of existing roads usually include the best quality material in the pavement and it makes sense to recover this material and use it to construct a new base or subbase layer. As illustrated in Figure 3.2, modern in situ recycling machines can achieve this in a single pass and have the added benefit of being able to simultaneously inject fluids (water and stabilising agents) to produce a homogeneous mix. Where new aggregates and/or powdered stabilising agents are required to be blended with the recovered material, these can be spread on the existing road surface ahead of the recycler and incorporated into the mix as the machine advances.

There are, however, limitations to in situ recycling. Recycling machines are not a panacea for all pavement rehabilitation projects and experience has shown that their application must be preceded by an exhaustive investigation exercise to determine the composition of the existing pavement, not only the material that is to be recycled to construct a new layer. It must be appreciated that recyclers can only recover material from the upper horizon of an existing pavement. The materials encountered are pulverised and mixed together, including any additives. Recyclers do not cross-blend material in the horizontal plane, in other words, transversely or longitudinally. The material in the vertical plane is mixed and blended together. This means that the nature of the product and its variability is dictated by the material in the existing pavement, plus additives. Stated differently, variations in the material encountered in the existing pavement will reflect as variations in the recycled material.

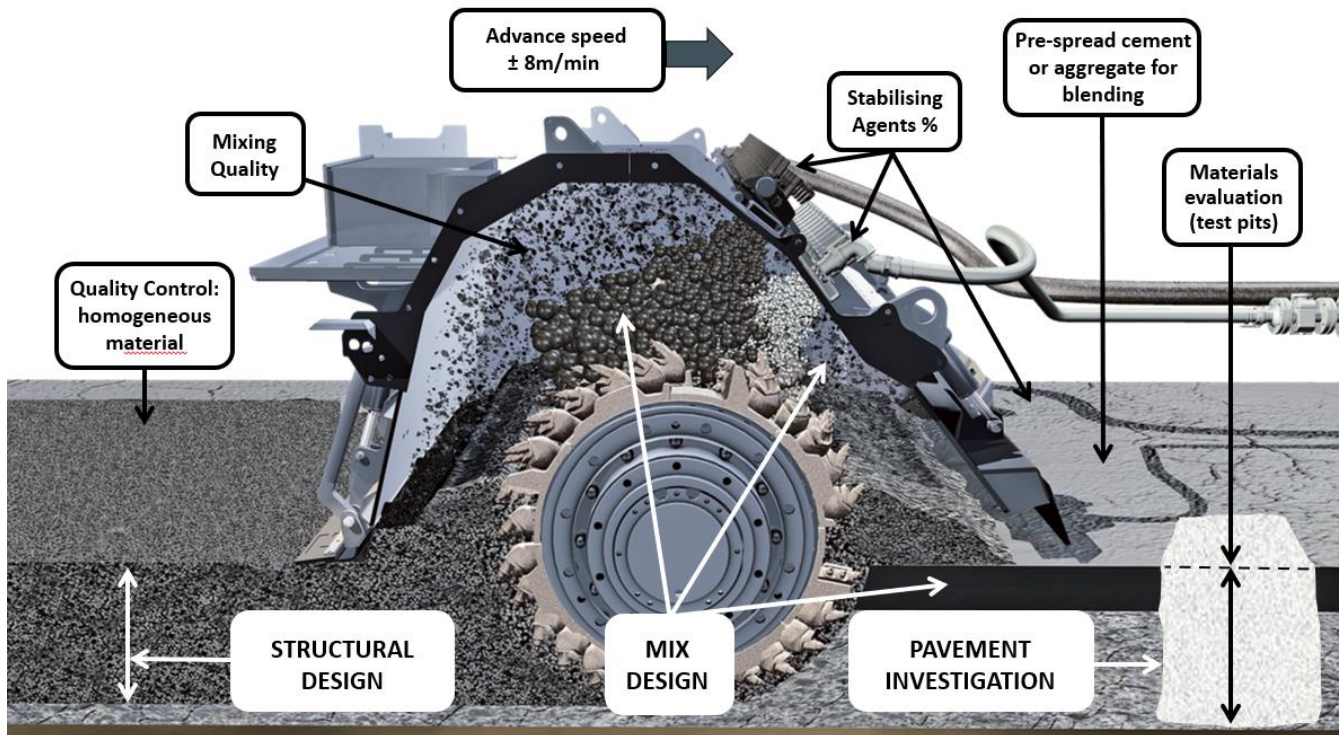

Figure 3.2 The In Situ Recycling Process

The depth of recycling generally dictates the thickness of the new layer. This, combined with any new material and stabilising agent added to the recovered material, determines the structural capacity achieved by constructing such a new layer on top of the underlying (undisturbed) pavement structure.

It is, therefore, of paramount importance to understand the composition of the existing pavement structure.

This chapter begins by explaining that in situ recycling may not be an appropriate process for all pavement rehabilitation projects. The investigations and analyses that must be undertaken to determine whether or not in situ recycling is appropriate are explained. A flow chart is provided to illustrate the sequence of procedures to be followed to determine the quality and variability of materials in an existing pavement structure and, for materials included in a designated recycling horizon, the additional tests and analyses required to determine material variability are explained.

Note: These explanations are applicable to all pavement rehabilitation projects, not solely those that involve in situ recycling and/or the incorporation of a bitumen stabilising agent.

3.1 IN SITU RECYCLING LIMITATIONS

The following sections describe some of the situations where in situ recycling is not an appropriate option for rehabilitating existing pavements.

3.1.1 Changes to the Existing Road Geometry

As was illustrated in Figure 3.2, recyclers run on top of the existing road with the cutting drum lowered into the underlying pavement. The depth of cut is measured relative to existing surface elevations and the recovered / treated material is placed back into the cut from where it originated, to be compacted and shaped.

It is obvious that such an operation eliminates the possibility of changing the horizontal alignment beyond the limits of the existing pavement structure.

For similar reasons, changing the grade line, for example, smoothing a vertical curve, is not possible. However, minor adjustments, such as raising or lowering final surface elevations, can be accommodated:

Minor increase in the final surface elevation. This can be accomplished by importing material on top of the existing road where, prior to recycling, it is spread, pre-compacted and shaped in accordance with the final levels. The thickness of such an imported layer is restricted by the depth of recycling; the depth of recycling must always be at least 50 mm greater than the thickness of the imported layer. As explained in Section 3.11, to ensure that a homogeneous mix is achieved, the existing pavement may need to be pre-pulverised, shaped and compacted prior to importing the layer of new material.

Minor decrease in the final surface elevation. Where the existing pavement structure is sufficiently deep, the surface elevations can be lowered by milling to remove surplus material prior to recycling. This option should only be adopted after checking to ensure that the material encountered by recycling deeper into the existing pavement structure will not contaminate the better quality material in the upper horizon.

3.1.2 Material in the Existing Pavement

Some materials encountered in distressed pavements cannot be broken down (pulverised) sufficiently by in situ recycling. These include:

- Severely distressed asphalt layers that exhibit closely-spaced crocodile cracks. Such a scenario is shown in Figure 3.3. The up-cutting rotation of the recycler's drum tends to lift such material in lumps (blocks), regardless of changes made to the advance speed, the rotation speed of the cutting drum and/or the positioning of the "breaker bar" on the front housing of the mixing chamber. These lumps tend to accumulate at the bottom of the cut.



Figure 3.3 Severely Distressed Asphalt

- Such material should be removed by pre-milling and replaced with a suitable alternative, for example, processed RA or graded crushed stone.
In order to extract optimal performance from RA, milling and processing in an impact crusher enables an appropriate RA grading to be generated.
- Binary aggregate systems, for example, waterbound macadam, where reconstitution of the combined grading is impossible by recycling. Layers of such material should not be recycled. These are special-purpose layers that form the backbone of a pavement structure and should, therefore, not be disturbed. Where such material is in a distressed state, it should be removed and replaced with an alternative material that can be recycled, for example, graded crushed stone.

3.1.3 Type of Project and Scope of Work

Urban pavements are not ideal for in situ recycling. Streets often have services buried in the pavement structure with manhole covers and valves located at the surface. These pose a problem, primarily due to the

discontinuities they create in the recycling operation, but such services are often aged and tend to break when the recycled material is compacted. In addition, vibrating compaction energy is often blamed for cracks developing in buildings adjacent to the road.

Furthermore, in situ recycling calls for a large machine to be coupled to at least one tanker, or two when a bitumen stabilising agent is applied. Such an operation is ideally suited to wide-open rural areas, not urban streets that generally offer a restricted working environment.

3.1.4 Recycling Machine

In situ recyclers are not all the same. There are several makes and models available and each has a specific range of capabilities. The main feature of a machine that determines its suitability for a specific project is power. The machine must be capable of pulverising the material in the existing pavement whilst maintaining sufficient speed of advance to pressurise the fluid being pumped to the application spraybars, plus push bulk tankers supplying the fluids.

Another important feature is the application systems for water and bitumen stabilising agents. These must be controlled by a microprocessor that regulates the flow rate to the spraybars in accordance with the advance speed which always varies because the resistance encountered whilst pulverising is not consistent. Two systems are essential when applying bitumen emulsion or foamed bitumen; one for the addition of water to achieve the required moisture content, the second to add the bitumen stabilising agent.

Wheel-mounted recyclers are the most popular machines due to their versatility. However, they cannot be used to recycle a partial thickness of asphalt because they develop a “bounce” due to tyre flex, resulting in serious damage to the cutting tools. Special-purpose track-mounted recyclers have been developed for such applications but are normally confined to markets where thick asphalt layers are common, for example, North America and Europe.

3.2 APPROACH TO PAVEMENT INVESTIGATIONS

The methodology described for investigating existing pavements in TRH 12 and SAPEM Chapter 6 is entirely relevant for pavements that are to be rehabilitated by in situ recycling and is, therefore, not repeated here. However, for in situ recycling projects, of primary importance is the identification and determination of variability in the components of the pavement structure and in the materials that fall within the recycling horizon.

Figure 3.4 shows the various steps required to formulate a suitable design for pavement rehabilitation by in situ recycling with a bitumen stabilising agent. Each step is discussed below under the section numbers shown.

3.3 IDENTIFYING UNIFORM SECTIONS

The first step in a pavement investigation exercise is to identify changes in the structural composition of the existing pavement. Variations in the underlying subgrade together with the materials that were used to construct the various pavement layers ensure that no significant stretch of road has an identical structure over its full length. This allows the road to be divided into a series of “uniform sections” and each treated in isolation, thereby simplifying the process of investigating long sections that can become laborious. Data from as-built records, traffic counts, automated pavement surveillance measurements and visual assessments can be used to delineate uniform sections during the condition assessment stage. At a more detailed level, further processing of deflection measurements, test pits, and dynamic cone penetrometer (DCP) test results can be used to refine the limits of these sections. SAPEM Chapter 6 outlines this process and discusses different tests and surveys. Two ways that are commonly used to identify uniform sections are highlighted in the following sections.

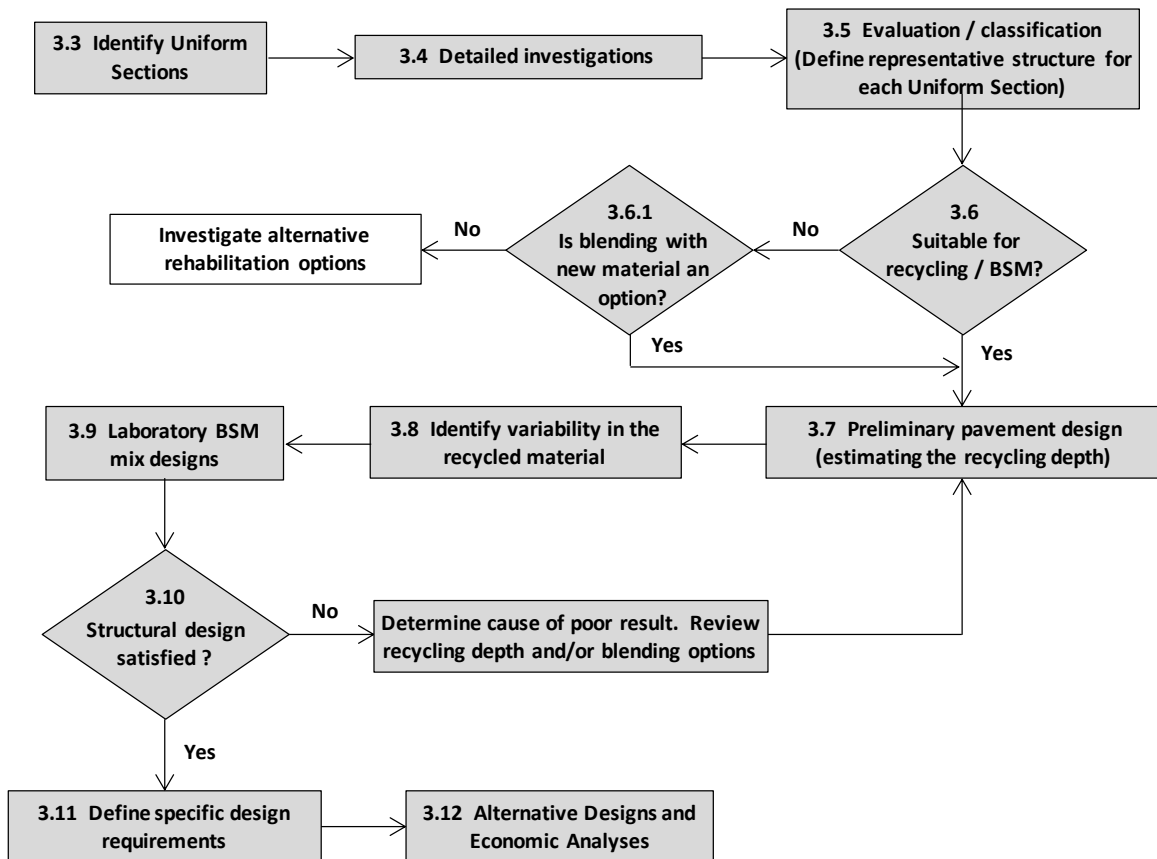

Figure 3.4 Pavement Investigation and Design Flow Chart for In Situ Recycling with BSMs

3.3.1 Deflection Measurements

Deflections measure the response of a pavement structure to an applied load. These measurements are used worldwide to monitor pavement performance, usually as a strength-derived input for Pavement Management Systems (PMS). Consequently, deflections are often measured on a regular basis, normally with a Falling Weight Deflectometer (FWD), although a Benkelman Beam is sometimes still used.

Analyses of FWD measurements can be used to produce a large amount of useful information concerning the pavement structure. Such information includes simple deflection bowl parameters as well as indices for the stiffness of individual layers determined by more complex backcalculation methods carried out on deflection bowls.

Whilst more sophisticated deflection analyses can be used in this process, they are normally confined to more detailed levels of pavement layer characterisation. Simple deflection measurements and deflection bowl parameters provide a useful starting point for all further investigations. These basic parameters namely, Maximum Deflection, Base Layer Index (BLI), Middle Layer Index (MLI) and Lower Layer Index (LLI) effectively provide measures of relative stiffness and an indication of the origin of deflections (or potentially weak zones) in the pavement. Since deflections measure the pavement’s response to an applied load, they can be used to identify where such response changes (provided the applied load remains constant). This can be achieved by carrying out the sum of cumulative difference analysis (CUSUM according to AASHTO, 1993) on a series of deflection measurements and plotting the results on a graph. A change in the trend of such a plot indicates a change in pavement response which, in turn, indicates a change in the pavement composition or condition.

Cumulative-sum analyses do not explain why the pavement is different or what has changed, they simply indicate that there is a difference. This provides an excellent focal point when carrying out a visual assessment to determine whether distress patterns seen on the road correlate with the changes indicated by deflection measurements.

3.3.2 Detailed Visual Assessment

Observations of the condition of an existing road and its surrounds are without doubt the most important step in the entire investigation process. Distress patterns, for example, crack intensity, type of cracking, deformation, etc., indicate the failure mechanism, while peripheral factors, such as over-grown side drains, provide vital clues as to the reasons for such distress. Time spent conducting a thorough visual assessment is never time wasted and should always be carried out by an experienced practitioner who not only knows what to look for but also understands what he/she is looking at.

The TMH 9 publication provides excellent guidelines for carrying out a visual assessment and these procedures can be implemented at project level by reducing survey segments to acceptable lengths. As a minimum, such a survey should be carried out on all projects, regardless of whether in situ recycling or other rehabilitation methods are under consideration.

Where in situ recycling is being considered, one of the more important features to observe on the road is the existing shape. As explained in Chapter 2, recyclers run on the existing road surface with the drum cutting into the underlying pavement. The cut horizon beneath the machine is dictated by the pitch and slope of the recycler. Where the camber of the road is 1%, the cut horizon will also be replicated as 1%. If the centreline surface levels are maintained, which is standard practice when recycling a 2-lane road in half-widths with each half-width recycled on different days, and final levels cut with a 2% camber, the resulting layer thickness towards the outer edge (the shoulder) will be thinner than required, as shown in Figure 3.5. This scenario results in the grader cutting the excess material to a windrow on the shoulder where it is picked up and removed from site.

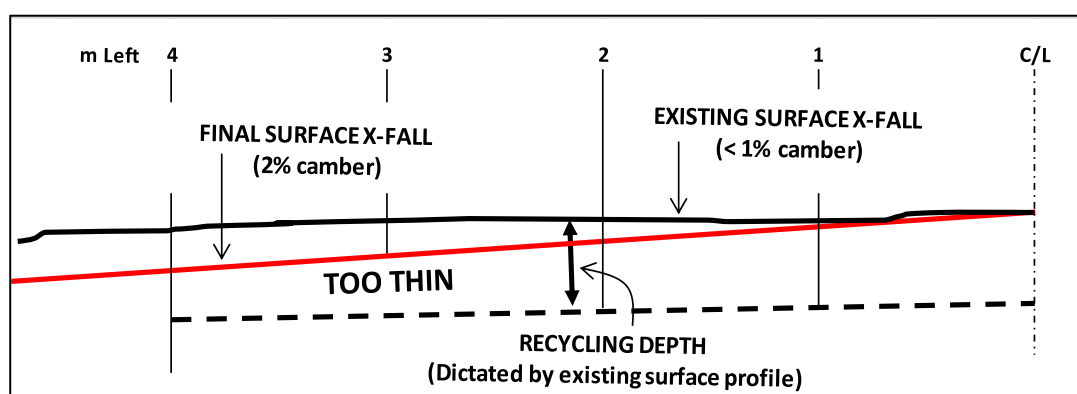

Figure 3.5 Consequence of Changing the Surface Cross-Fall

Such loss of layer thickness falls beneath the outer wheel path, the most heavily loaded part of the pavement, thereby reducing the structural capacity of the newly rehabilitated pavement.

Where the existing surface shape is identified as being a potential problem, a comprehensive survey should be undertaken and a proper geometric evaluation carried out, bearing in mind that any significant departure from the existing geometry will eliminate the possibility of in situ recycling (as explained in Section 3.1.1).

3.3.3 Adjusting the Uniform Section Boundaries

After completing the visual assessment, the boundaries of the identified Uniform Sections from, for example deflection measurements, should be adjusted to take cognisance of specific observations. Where deflections suggest a change in pavement response is combined with observations of poor drainage, the boundary may need to be moved accordingly.

In carrying out this exercise, the objective is to find visual evidence of the cause of the change in pavement response as seen from deflections. However, there is a good deal of subjectivity involved and this work should, therefore, be guided by an experienced practitioner. It must be appreciated that the accurate definition of Uniform Sections is extremely important because the detailed investigations described in the following sections all focus on these Uniform Sections, one at a time.

3.4 DETAILED INVESTIGATIONS

Detailed investigations are carried out to determine the composition of the existing pavement, identify the material in each different layer (and underlying subgrade) and the reason for the distress that is evident. Sufficient surveys and tests need to be undertaken to have confidence in the representative pavement structure that is determined for each Uniform Section. The material classification system introduced in Section 3.5.2, as well as the full method included in Appendix A, offers an approach to classify the materials and to quantify the effect of sample size on the certainty level of the resulting classification.

3.4.1 Test Pit Excavations

Test pits are the only means to conclusively determine the composition of the full pavement structure and the type and quality of material in all component layers, including the subgrade. The procedure for excavating test pits, conducting tests inside the excavation and sampling is well understood by all involved in the road rehabilitation industry and, therefore, needs no further explanation. However, the location and number of test pits that should be excavated is invariably questionable, primarily due to cost. Test pitting is time consuming, involves traffic accommodation and must always be supervised by an experienced practitioner.

To speed up the excavating process and eliminate the need for road closures, test pits are sometimes located on the shoulder, adjacent to the edge of surfacing. This is not recommended for the simple reason that the pavement beneath the shoulder is not necessarily representative of the pavement structure in the carriageway, especially on older roads. Unless there are valid reasons for doing otherwise, test pits should always be located in the outer wheel paths of the trafficked lanes.

Ideally, a minimum of three test pits should be excavated in each uniform section; one located where distress is evident, one where there is no distress and a third where the road condition is judged to be representative of the average condition. Additional test pits are usually excavated where the uniform section is in excess of 5km as well as at locations where specific information is required.

Test pits are normally excavated to the depth of the subgrade, 1.5 m in length and 1 m wide, positioned across the outer wheel path. They are sometimes extended across the full lane width to provide information concerning previous widening exercises and /or for identifying problems in a specific layer. Samples are taken from each layer encountered and stored separately for laboratory testing. Where recycling is envisaged, sufficient material for mix designs needs to be taken from each layer likely to fall within the recycling horizon.

3.4.2 Sampling Asphalt Layers

Obtaining a sample of the asphalt component from an existing pavement and the subsequent preparation for inclusion in a stabilisation mix design procedure is a much-debated subject. Section 3.2.1 explained the scenario for dealing with pavements where the asphalt is severely distressed or plagued by closely-spaced crocodile cracks; the asphalt should be milled off and either pretreated for subsequent reuse or removed from site. However, where the asphalt is not so severely distressed and the intention is to recycle it together with the underlying pavement material, the method used for sampling and preparation is important because it must simulate the material that will be produced by a recycler.

The following sections describe three methods to sample the asphalt, together with their respective pros and cons.

3.4.2.1 Use a Recycler to Recover a Sample of Pulverised Asphalt

Although this is the best way to obtain a representative sample, the following factors need to be considered:

- **Recyclers are not all the same.** The pulverised product from a small machine is not the same as that produced by a large powerful recycler, making it important to utilise an appropriate machine for the sampling exercise. Although details of the rehabilitation process are seldom known when investigations are carried out, it is important to estimate the type and size of machine capable of recycling the pavement being investigated if this method of sampling is adopted.

- **Cost.** Establishing a recycler for the purpose of taking samples is an extremely expensive exercise, unless there happens to be a suitable recycler in the vicinity.
- **Recycler operation.** Drum rotation speed and the speed at which the recycler advances have a direct influence on the grading of the recovered asphalt. To obtain a representative sample necessitates the machine to advance from stationary to normal operating speed and then at least another 5 m, resulting in a cut length of some 8 to 10 m. Backfilling and reinstating such a cut requires a small construction team that adds significantly to the cost of obtaining samples.

3.4.2.2 Use a Small Milling Machine to Recover a Sample of Pulverised Asphalt

This appears to be a realistic way of obtaining a representative sample. However, pulverised asphalt produced by a milling machine is not the same as that produced by a recycler with a significantly larger milling drum. The peripheral speed of the cutting tools on a milling drum is significantly slower than those on a recycler's drum. In addition, the way the machine is operated largely dictates the degree of pulverisation and, therefore, the grading of the milled product. Often a small milling machine with a drum width of 1 m is used to mill a small area, typically the size of a test pit. The drum is lowered to the bottom of the asphalt layer and the machine slowly moves forward about 1 m, grinding the material. The grading of such a sample of RA is certainly not representative of that produced by a recycler.

If a milling machine is used, the drum must first be lowered to the bottom of the asphalt layer before the machine advances for at least 5 m at a speed of between 5 and 8 m/min. The sample is then taken from the middle of the milled section. The reinstatement work required after sampling is similar to using a recycler.

3.4.2.3 Breaking Down Slabs of Asphalt in the Laboratory

This has proved to be the most effective way of obtaining a realistic sample. Slabs are cut from the surface of test pits using a concrete saw and transported to the laboratory. In the laboratory the slabs are broken down, either manually using 4 pound hammers, or passed through a small jaw crusher so that 100% of the sample passes the 20 mm sieve.

It must be borne in mind that BSM mix designs are routinely carried out on samples with a maximum particle size of 20 mm. Where a sample of component material includes particles that are > 20 mm, these are broken down to pass the 20 mm sieve and retained on the 14 mm sieve. This is achieved by breaking down the oversized material manually, or by passing through a small jaw crusher, as described in the above paragraph for breaking down slabs of asphalt.

Samples of all component materials in the recycling horizon are independently prepared in this manner before being blended proportionately by volume, based on the thickness of the respective layers. A coarse RA sample obtained from site will, therefore, receive similar treatment to that imposed on asphalt slabs, resulting in a similar grading. This is certainly not the case when the asphalt sample was finely ground in a milling process.

3.4.3 Standard Laboratory Tests

Material sampled from each layer encountered in the test pits is retained in sealed containers and transported to a suitable laboratory for testing. The results from standard laboratory tests, for example, sieve analysis, Atterberg Limits and CBR, are used to classify the material. Additional tests can also be performed to determine other properties of the material, such as, durability.

3.4.4 Extracting Cores

Where the existing pavement includes layers of bound material, for example, asphalt and layers of cemented material, the thickness of these layers should be determined by extracting a series of cores. The thickness of bound material is measured on the face of the core hole. Core recovery can be difficult and is not always 100%. This information is then used to determine whether the pavement can be recycled in situ. As explained in

Section 3.1.4, wheel mounted recyclers must penetrate through the full thickness of asphalt in order to pulverise the material. In addition, thick layers of strongly cemented layers may need to be pre-pulverised for the recycler to be able to achieve sufficient advance speed when treating with a bitumen stabilising agent.

As with test pits, an experienced practitioner should supervise the operation to ensure that coring continues through the full thickness of bound layers. To prevent jamming, operators of coring machines tend to stop as soon as the core barrel starts “wobbling”, suggesting that they have reached the bottom of the bound material. The material at the bottom of the core hole should, therefore, be tested using a crowbar to ensure that the hole has indeed reached the bottom of all bound material.

Coring is a relatively quick-and-easy operation that provides important information at a reasonable cost. It, therefore, makes sense to extract cores at regular intervals of approximately 500 m in both wheel paths and on both sides of a 2-lane road, or in each lane of a multi-lane carriageway.

Specimens cut from core samples may also be tested to determine the relative strength of the material which provides a useful indication of whether or not the layer can be recycled in situ. Additional tests to determine the composition of the asphalt mix (e.g. aggregate grading, binder content, etc.) are irrelevant when the intention is to recycle the existing pavement and stabilise with bitumen. When recycled, the asphalt is broken up (pulverised) and is considered as aggregate. However, as explained in Section 4.2.1.1, where asphalt accounts for more than 75% of the recycled horizon, samples of the RA need to be checked to ensure that the binder has aged sufficiently to allow the RA to be classed as aggregate (black rock).

3.4.5 Dynamic Cone Penetrometer (DCP) Surveys

DCP probes provide valuable information when used in standard materials (see Section 3.5.2 and Appendix A). DCPs are ideal for the relatively fine grained materials normally encountered in the lower regions of the pavement, but tend to refuse when driven into hard, coarse material. The rate of penetration achieved and change in penetration rate is then calculated and can be used to indicate layer thickness and to derive in situ CBR or elastic modulus values using empirical relationships.

DCP probes fall into the class of “non-destructive” testing, providing useful information on the undisturbed properties of the material in pavement layers. The DCP apparatus is simple and the test is relatively quick to perform using unskilled personnel. The cost of each probe is, therefore, not expensive and one team can complete several probes in an hour, especially when disposable cone tips are used.

To expedite production, 25 mm diameter holes can be drilled through the upper portion of the pavement. Data from test pits and cores can be used to gauge the thickness of “tough material” in the pavement, providing the depth to which the hole should be drilled. In addition, probes are usually driven from the bottom of core holes, after removing all water used in the coring operation, and from different horizons whilst excavating test pits

It must be appreciated that the information obtained from a DCP probe is at best an indicator of the properties of the material in a pavement layer. However, data collected from several probes can be analysed statistically and, the more data analysed, the greater the confidence that can be placed on the results. Thus, a DCP survey normally includes probes driven every 100 to 200 m per lane over the length of the road being investigated, alternating between both wheel paths and both sides of the road.

3.4.6 Analysis of Deflection Bowls

Data obtained from test pits, core extractions and DCP probes can then be interrogated to determine the thickness of the various layers in the pavement and the type of material in each layer. This information can then be used as input to backcalculate a representative stiffness of each layer using deflection bowls. Several software packages are available for such analyses. However, this is work that should only be undertaken by an experienced practitioner because, as with all software, garbage in = garbage out. (For example, if the assigned thickness of a layer differs by 15% from the actual, the backcalculated stiffness value for that layer will be over- or understated by some 50%).

3.5 EVALUATION / MATERIAL CLASSIFICATION

The investigation phase of a project culminates in assembling all the data obtained and using it to determine the composition of the pavement structure in each uniform section together with the classification of the material in each pavement layer. A method that has been developed specifically for this purpose is described in the following sections.

3.5.1 Data Synthesis and Structural Interpretation

All data collected from the various observations, surveys and tests need to be assembled in a rational format that allows the “whole picture” to be assessed. TRH 12 contains useful guidelines for compiling such data on a single sheet for each uniform section. “Stripmaps” that use commercial software are becoming increasingly popular as more engineers become acquainted with their ease-of-use. The benefits that accrue from utilising such a computer-based process include options for collating and manipulating the data, the ability to import different data sets, for example, photographs, and the confidence that such a process generates.

It is important to ensure that the objectives of carrying out this laborious exercise are not lost in the detail. These objectives are to determine:

- Existing pavement structure for each uniform section.
- Class of material in each component layer.
- The failure mechanism responsible for the current distress.

Stripmaps are ideal for larger projects where dealing with large volumes of data can become unmanageable. On smaller jobs, however, Microsoft Excel spreadsheets are often adequate.

3.5.2 Material Classification

Classifying materials is an important part of determining the existing pavement structure. The Design Equivalent Material Classification (DEMAC) system complements the pavement investigation and design process, providing a systematic approach to collate and interpret all materials related data. The concept of material classes originally defined in the South African Technical Recommendation for Highways: Guidelines for road construction materials (TRH14, 1985) serve as general reference. The material classes under consideration are widely used in the southern African road building industry and are generally adopted and refined for use in design, for example, TRH4, specifications such as COLTO, 1998, and elaborated upon, as is done in TG2. Assignment of a material class essentially simplifies the interpretation of many tests or indicators, assuming that the range of classes represent different material qualities and associated performance characteristics. In the context of pavement rehabilitation, the determination of material classes for each pavement layer is a critical aspect of the structural design process as it effectively dictates the structural design inputs.

In this section, a method for classifying materials is presented. The objective of the method is to provide a reliable, rational and consistent indication of the appropriate material class. The system can be used for all pavement materials that are commonly used in southern Africa and in all pavement design contexts. However, the method is particularly appropriate for rehabilitation, specifically recycling, as the quality of the existing material is not typically engineered but must be well characterised while subjected to potential high variability. In the context of pavement investigation and design, the material classification system can be used to:

- Classify in situ materials to provide guidance for selection of the respective layer stiffness (M_R) input values in the pavement design models, or as direct inputs to the Pavement Number design method.
- Complement the mix design process through classification of in situ materials to verify the representativeness and suitability of the material for bitumen stabilisation.
- Classify the in situ supporting layers to verify the suitability of the pavement for in situ recycling with a bitumen stabilising agent.

The sections below describe the concepts, introduce the basic method and provide recommendations for its use. The material classification system forms an integral part of the TG2 design approach and the method is, therefore, described in full in Appendix A.

3.5.2.1 Concept

Many material classification methods are specification-type approaches that rely on “pass” or “fail” criteria. For these types of approaches, if any one test fails the criteria for the material class then the material cannot be classified as that class. For example, if the Plasticity Index value is above the specification for a G4 material, then the material cannot be classified as a G4 even if all other available test results meet the G4 criteria.

The concept underlying the material classification system is to use all available material information to give a consistent, rational and objective assessment of a material class. The system gives a holistic assessment that works best when a comprehensive range of test indicators are used. This approach is more rational, albeit less exact and can handle vagueness in the data. Rather than giving a binary “yes” or “no” answer, the method indicates the conformance to a material class in less restrictive terms. The approach associates a certainty that a material can be considered as a particular material class and uses Fuzzy Logic with Certainty Theory to provide this type of assessment.

The result of the material classification process is a Design Equivalent Material Class (DEMAC), denoted by prefix DE-, for example, DE-G5. A DEMAC represents a material that exhibits shear strength, stiffness, durability and flexibility properties similar to a newly constructed material of the same class. DEMAC classification implies that the material may not meet exact specifications for a particular material class but, in terms of shear strength and stiffness behaviour, the material is similar.

Design Equivalent Material Class (DEMAC)

A DEMAC denotes a material that exhibits shear strength, stiffness and flexibility properties similar to newly constructed material of the same class.

3.5.2.2 Material Classification System

The material classification system is broadly divided into granular materials and cement stabilised materials.

The granular system assigns a material to one of ten material classes that resemble the South African classification (TRH14), namely G1 to G10. The system for cemented materials assumes that the user has knowledge that the layer under consideration is stabilised or was originally stabilised. The design equivalent classes for these materials also resembles the original TRH14 with C2, C3, and C4 classes. In addition, the system makes provision for different cemented material behavioural states as defined by the equivalent granular (EG) concept and adopted in South African pavement design methods.

The method works by determining, for each test result available, the certainty that the material falls into specific material classes. The tests or indicators that are used for assessment of materials in the material classification, their relevance and interpretation are provided in Appendix A:

- Table A.4 lists the tests and indicators for granular materials and their relevance for the material classification system.
- Interpretation of granular tests and indicators are furnished in Table A.5 (laboratory indicators and tests) and Table A.6 (in situ and field indicators and tests).
- Grading, consistency, visible moisture and historical performance requires a qualitative rating; additional details on interpretation of these indicators and/or assignment of ratings are provided in Table A.7 (historical performance), Table A.8 (consistency) and Figures A.4 and A.5 (grading).
- The tests and indicators and their interpretation for the classification of cemented materials are detailed in Table A.9 and Table A.10, respectively.

The certainty that the material is associated with a class is carried out using the 10th percentile, median and 90th percentile of all the results from the specific test, as illustrated in Figure 3.6 for FWD backcalculated stiffness and

DCP data. The blue lines represent the 10th and 90th percentiles and the red dot the median. The certainty that a material belongs to a particular DEMAC is dependent on how much of the data falls into that class. The specific details of the calculation are given in Appendix A. Using Figure 3.6 as an example, the stiffness suggests that the material is either a design equivalent C4 (DE-C4) or design equivalent EG-4 (DE-EG4), and the DCP suggests a DE-C3, DE-C4 or DE-EG4.

Test or Indicator	Material Class			
	DE-C3	DE-C4	DE-EG4	DE-G5
FWD-derived Stiffness (MPa)	> 1 200	500 to 1 200	250 to 800	< 250
DCP Penetration (mm/blow)	< 1.5	< 3		> 3

Figure 3.6 Example of Interpretation of Test Results

Because most tests carried out on pavement materials provide only a partial indication of the material behaviour, each test is assigned a certainty factor. From Certainty Theory, this certainty factor (CF) essentially represents the “subjective confidence” in the ability of a test to serve as an accurate indicator for material strength and stiffness. The value of CF ranges from 0 to 1, with a value of 1 indicating absolute confidence in a test or indicator, or in other words, highly likely. Using the spread of data for each test and the certainty factor, the cumulative certainty that a material falls into one of the material classes can be calculated. The more tests that are utilised, the higher the cumulative certainty. The details of this calculation are included in Appendix A. The method can be applied using a spreadsheet but is also conveniently included in commercially available pavement design and analysis software.

3.5.2.3 Confidence in Assessment and Application

The confidence associated with the assigned material class depends on the number of tests or indicators used and the certainty factors assigned to the tests and indicators. The degree of confidence in the assessment is thus quantified by the certainty of the assessment, and this is an indirect indicator of the reliability of any design which is based on this assessment. Table 3.1 provides some guidelines to assess the confidence associated with the material classification and recommendations for its use in rehabilitation design applications.

3.5.2.4 Bitumen Stabilised Materials

Bitumen stabilised material classes BSM1 and BSM2 are defined in Chapter 4. Both classes represent a BSM design equivalent material class (DEMAC). Previous editions of TG2 included a different system for classifying a BSM by assessing the suitability of a material for treatment with bitumen emulsion or foamed bitumen. Materials were assessed essentially using the same tests and indicators as for granular materials, with the addition of BSM test results from the mix design process.

In this edition, the required BSM class is ascertained using the mix design process outlined in Chapter 4. Whilst the BSM mix design process inherently accommodates evaluation of the suitability of the material for bitumen stabilisation, the Material Classification System complements this process by producing an equivalent material class potentially based on larger sample sizes, thereby addressing the risk of spatial variability. A simplified approach is, therefore, provided in this edition where the suitability of the material is verified based on classification of the candidate material using the system for granular materials. Because it is recommended that BSMs have a maximum addition of 1% cement, assessment of existing BSM layers during rehabilitation investigations can also be done using the granular system. Based on the design equivalent material class concept, the in situ shear strength, stiffness and flexibility properties represent the assigned DEMAC.

Table 3.1 Relative Confidence of Materials Classification and Recommended Application

Final Certainty	Confidence in Classification and General Considerations	Recommended Application Service Level Considerations
< 0.3	Very low confidence. It is strongly recommended that more data be gathered to enable a more confident assessment to be made.	Inadequate
0.3 to 0.5	Low confidence. Suitable only for situations where the existing pavement condition and age is such that structural rehabilitation will not be considered or is very unlikely.	Category D Roads
0.5 to 0.7	Medium. Suitable for situations where the existing pavement condition and age is such that structural rehabilitation is unlikely, or for which the condition and/or other factors predetermines the treatment type.	Category C Roads 0.5 – 0.6
		Category B Roads 0.6 – 0.7
> 0.7	High. This is the minimum recommended certainty for situations where structural rehabilitation is likely, and for which the rehabilitation design will rely completely on the quality and state of existing pavement layers.	Category A Roads

3.5.3 Representative Pavement Structures

The next task is to determine a representative pavement structure for each Uniform Section. As shown in the example in Figure 3.7, this is best accomplished by compiling a table showing the different layers together with the relevant certainty factors for each identified class of material. Back-calculated stiffness values (M_R) for each layer are included in the table as they are an important guide for the design process that follows.

	Material		Layer thickness		Backcalculated M_R		Design Input	
	DE-class	Certainty	Range	Mean	Range	Mean	Thickness	Class
	HMA	1.0	30 - 50	42	930 - 2860	1900	40	HMA
	G3	0.1	135 - 165	139	195 - 470	320	140	G4
	G4	0.7						
	G5	0.2						
	EG5	0.4	225 - 260	232	95 - 285	185	230	EG6
	EG6	0.5						
	EG7	0.1						
	G6	0.1	135 - 185	158	70 - 150	105	160	G7
	G7	0.8						
	G8	0.1						
	G7	0.2	125 - 180	152	55 - 110	85	150	G8
	G8	0.6						
	G9	0.2						
	G9	0.8		∞	45 - 65	60	∞	G9
	G10	0.2						

Figure 3.7 Example of a Representative Pavement Structure

Where there are overlaps or discrepancies between adjacent Uniform Sections, the boundaries should be adjusted accordingly. The “Design Input” data shown in the columns on the right of Figure 3.7 forms the primary input for pavement design and is, therefore, an exercise that calls for engineering judgement and experience.

History has shown that inexperienced engineers tend to be optimistic while the more experienced practitioners tend to be more cautious, especially in the determination of DE material classes. Where there is clearly insufficient information available (lack of certainty), additional tests should be carried out, guided by the gap in the data. However, as with all exercises requiring judgement, the results should be thoroughly checked (peer reviewed) before being accepted as de facto.

3.6 SUITABILITY FOR RECYCLING AND BITUMEN STABILISATION

The information described above for each uniform section is sufficient to determine whether the pavement is a suitable candidate for in situ recycling with a bitumen stabilising agent. This is dictated by the type and quality of material encountered in the upper portion of the pavement that falls within the potential recycling horizon.

As introduced in Chapter 2 and explained in detail in Chapter 4, not all materials are suitable for stabilising with bitumen. Where the material in the potential recycling horizon cannot be recycled, for example, waterbound macadam, or fails to meet the minimum quality requirements for bitumen stabilisation, for example, DE-G7 base material, there is no point in continuing with the design process unless a feasible solution is available. Such solutions usually call for the construction of new pavement layers above the unsuitable base material. However, if recycling is the preferred rehabilitation method and the material in the potential recycling horizon is of marginal quality, consideration should be given to importing good quality material for blending in the recycling process, as explained below.

3.6.1 Blending with New Imported Material

Where material in the potential recycling horizon is of marginal quality, for example, G6, importing good quality material, such as G2, and spreading it on top of the existing road surface for recycling together with a portion of the underlying base is common practice. The results from laboratory tests are used to indicate the blend proportion required to address the quality concern that classified the existing base material as marginal. For example, assume that the reason for classifying the existing base material was a CBR result of only 40%. By adding 25% of fresh G2 quality material, the blend is more than likely to achieve a CBR value in excess of the minimum 45% required for G5 classification. The quality achieved by such blending should, however, always be checked by carrying out additional laboratory tests.

Section 3.11.2 explains some of the construction concerns that must be considered when blending.

3.7 PRELIMINARY PAVEMENT DESIGN (ESTIMATING THE RECYCLING DEPTH)

The structural capacity requirement is the starting point for pavement design; the number of equivalent 80kN axle loads the rehabilitated pavement must withstand during the service life before a failure condition is reached. In addition, the anticipated traffic spectrum and climate influences the type of surfacing that should be applied. Chip seals are applied in drier areas where the traffic is light to moderate whilst asphalt is preferred in wetter regions with moderate to heavy traffic.

The next step is to determine whether the existing pavement is suitable for in situ recycling. This involves an assessment of the current pavement structure to determine whether the structural capacity requirement can be met by simply recycling the uppermost portion and stabilising the material with bitumen. The pavement defined for each uniform section is considered independently by:

- Assessing the quality of material in the upper horizon to ensure that it meets the minimum requirements, see Section 2.7 and Chapter 4.
- Assuming a classification for the material after stabilisation, BSM1 or BSM2.
- Using a pavement design method, such as Pavement Numbers or mechanistic analysis described in Chapter 5, determine the thickness of the recycled BSM layer that meets the structural capacity requirement.

It must be appreciated that each uniform section may require a different BSM layer thickness (recycling depth) to achieve the required structural capacity. An example of the end product that emanates from such an exercise is shown in Figure 3.8.

The composition of the material in the recycling horizon can be seen from this figure: the full thickness of asphalt and G4 layers plus a portion of the subbase layer that was previously stabilised with cement.

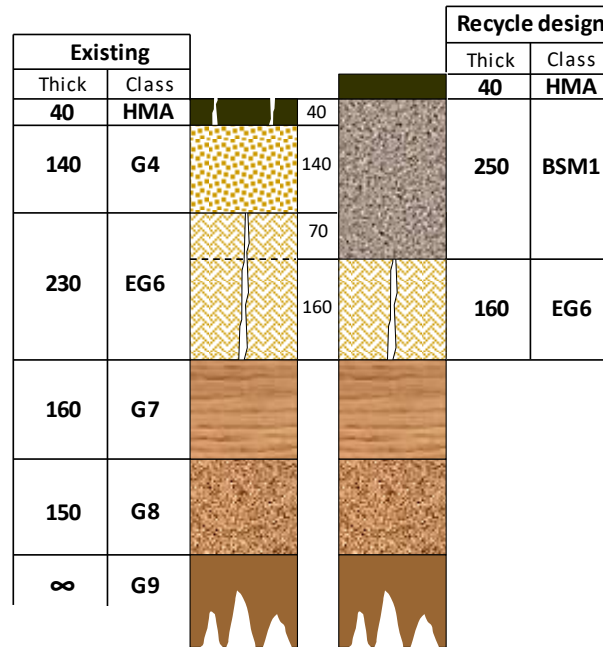

Figure 3.8 Estimating the Depth of Recycling

The key assumption made in this exercise is that the combination of these materials will produce a BSM1 classification when stabilised with bitumen.

Note: The following limitations to the finished layer thickness (after compaction) should always be respected when working with in situ recyclers:

- Minimum of 150 mm (there needs to be sufficient material in the mixing chamber); and
- Maximum of 300 mm (compaction challenges, unless special-purpose rollers are applied).

3.8 ASSESSING VARIABILITY IN THE RECYCLED MATERIAL

Whilst variability in the quality of the in situ material is assessed through test pitting and application of the materials classification system, a more detailed assessment focusing on the horizon of interest can be carried out to determine whether a single mix design will suffice and to minimise risk during construction. Such an assessment can conveniently be performed at the onset of the construction stage by excavating small sampling holes in the wheel paths at regular intervals (normally 500 m), measuring the thickness of the different layers and retaining the material encountered in the recycling depth. Simple indicator tests, gradings and plasticity, are used to assess variability. Table 3.2 shows an example of such a process.

Where significant variability is encountered within a specific uniform section, the number of stabilisation mix designs is increased accordingly. The example shown in Table 3.2 indicates that an additional mix design should be considered for the section between 23+500 and 24+000 where an asphalt overlay was applied.

The additional mix design will show whether the change in material over this section warrants changing the design, especially the application rate of stabilising agent.

Table 3.2 Example: Laboratory Results Indicating Material Variability

Chainage	Location	Layer thickness (mm)				Combined grading						Grading modulus	Plasticity Index
		Total	HMA	Base	S/base	19.0	13.2	4.75	2.0	0.425	0.075		
20+500	IWP R	200	35	115	50	100	95	62	45	25	11	2.19	6
21+000	OWP R	200	30	115	55	100	99	68	49	26	10	2.15	6
21+500	IWP R	200	30	125	45	100	96	63	49	24	9	2.18	4
22+000	IWP L	200	35	130	35	100	99	65	47	20	10	2.23	4
22+500	OWP L	200	35	120	45	100	95	64	48	24	11	2.17	6
23+000	IWP L	200	25	125	50	100	99	69	50	25	10	2.15	6
23+500	IWP R	200	80	120	0	100	74	47	30	16	6	2.48	NP
24+000	OWP R	200	75	125	0	100	71	48	36	19	5	2.4	NP
24+500	IWP R	200	30	125	45	100	89	61	48	24	10	2.18	4
25+000	IWP L	200	25	130	45	100	92	63	51	26	9	2.14	6
25+500	OWP L	180	30	120	30	100	97	65	51	22	9	2.18	4
26+000	IWP L	200	35	125	40	100	96	59	49	21	11	2.19	6

3.9 STABILISATION MIX DESIGN FOR EACH UNIFORM MATERIAL

The mix design procedure for stabilising with either bitumen emulsion or foamed bitumen is described in Chapter 4. Such mix designs are to be carried out on representative samples taken from the recycling horizon at locations identified in the exercise described above for each different blend of material.

Normal practice is to follow the initial steps of the mix design procedure to determine the preference for active filler (if any) and the optimum application rate for the bitumen stabilising agent. Indirect Tensile Strength (ITS) test results are used to identify significant differences between the different blends of material. Triaxial testing is then undertaken on mixes that show a distinct difference, both in terms of ITS values and bitumen demand.

These results are then used to classify the material as a BSM1 or BSM2 together with the accompanying certainty factor. A mix that fails to meet the minimum BSM2 requirements is a clear indication that the untreated material is not suitable for stabilising with bitumen.

3.10 STRUCTURAL DESIGN VERIFICATION

The BSM classification achieved for the blend of material in each uniform section is then checked against the design assumptions made in determining the depth of recycling. Where the assumption is validated, the design can be adopted with confidence. Where the assumed classification was incorrect, either over- or under-valued, then the entire process needs to be revisited by returning to Section 3.7 and starting again.

Where BSM2 class of material is anticipated and the mix design indicates with certainty that a BSM1 class can be achieved, the recycling depth / BSM layer thickness can be reduced. However, the consequence of changing the blend of material in the (reduced) recycling horizon needs to be checked to ensure that the BSM1 classification is maintained. This may require an additional mix design to be undertaken.

Where a BSM1 class of material is anticipated and the mix design indicates that only a BSM2, or worse, can be achieved, the reason for such a reduction in quality needs to be established. In other words, what caused the class to be so different from that expected from the initial assessment?

Such a scenario is normally the consequence of the chosen recycling depth penetrating into an underlying layer of poor-quality material. As shown in the example in Figure 3.9, this can be rectified by importing good quality material, such as G2, and spreading as a layer on top of the existing surface before recycling. However, the consequence of variations in the resulting blend of imported and in situ materials, and raising the final surface levels by 110 mm in Figure 3.9, must be taken into consideration before embarking on further evaluations.

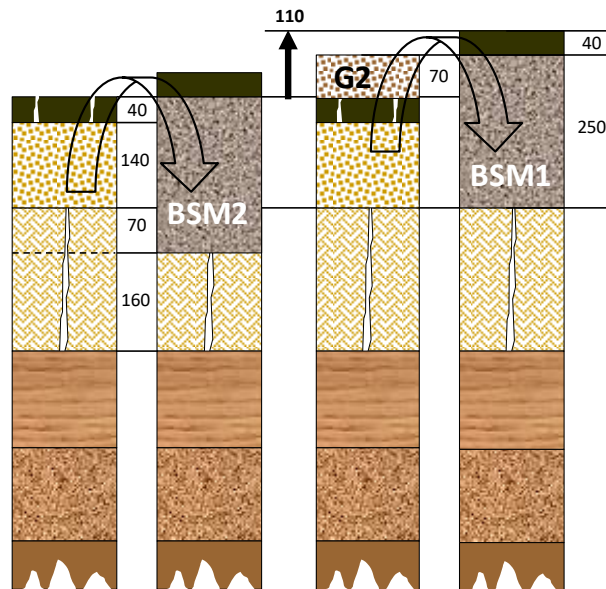

Figure 3.9 Material Import to Improve the Mix

Where the classification requirement cannot be achieved due to some unforeseen deficiency in the recycled material (for example, where a thick asphalt component includes a high percentage of bitumen rubber), then an alternative strategy to in situ recycling needs to be explored. Such a scenario can often be addressed by removing the offensive material, blending it in a stationary plant with other virgin or recovered pavement material and using the treated blend to construct a new layer (normally placed by paver).

3.11 DEFINE SPECIFIC DESIGN REQUIREMENTS

The design procedures described in the preceding sections provide the thickness of the new BSM layer required for each uniform section together with the application rates for active filler and bitumen emulsion or foamed bitumen to achieve the required BSM classification.

To complete the design process, the practicalities of in situ recycling need to be considered. Specific construction requirements must be detailed in the contract documentation for each uniform section. Two concerns specific to in situ recycling are discussed below.

3.11.1 Achieving the Required Layer Thickness

As explained in Section 3.1 and 3.3.2, a recycler runs on the road surface with its cutting drum lowered into the underlying pavement. Recyclers are usually set up by “zeroing” the drum to ensure that the cut horizon is maintained at a consistent distance below the chassis of the machine. In this way, the cut horizon mirrors the slope of the machine. Where the cross-fall changes, the slope of the machine will follow the change and this change will be reflected in the cut horizon. Figure 3.10 illustrates what happens to the cut horizon where the surface of a 4 m wide half road-width (indicated by the solid black line) has deformed and lost its shape.

Once the material has been recycled and pre-compacted, final levels are cut to achieve the correct camber, in other words, the “final surface shape” line in Figure 3.10. As shown, the resulting layer thickness will vary across the width. In this example, the structural capacity of the pavement falling beneath the outer wheel path will be significantly less than the design requirement, thereby compromising the structural capacity of the pavement.

This potential problem must be addressed during the design process since remedial measures may affect the blend of material in the recycling horizon. Such remedial measures normally require either pre-pulverising the material in the existing pavement or importing new material. Either pre-pulverised or imported material can then be pre-shaped in accordance with the final line-and-level requirements before being recycled and stabilised.

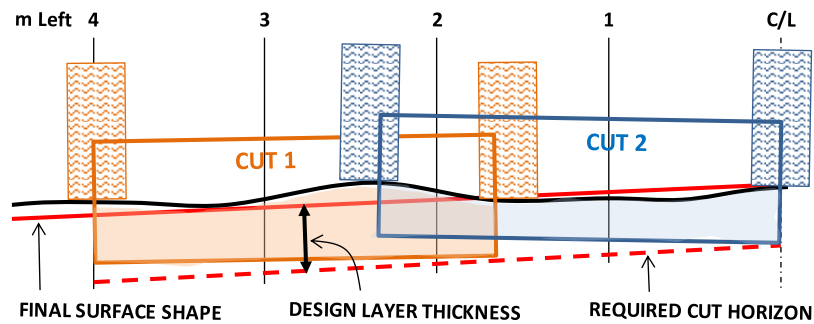

Figure 3.10 Recycling where the Surface is Out of Shape

3.11.2 Achieving a Consistent Mix

Importing new material for shape correction inevitably results in a variable thickness of the new material, as shown in the upper part of Figure 3.11. Clearly, the thickness of imported material 1 metre left of centreline is significantly greater than that 2.5 m from centreline. Where the material in the existing pavement is of a different quality from the imported material, the resulting blend across the road width will be variable when recycling to the required depth.

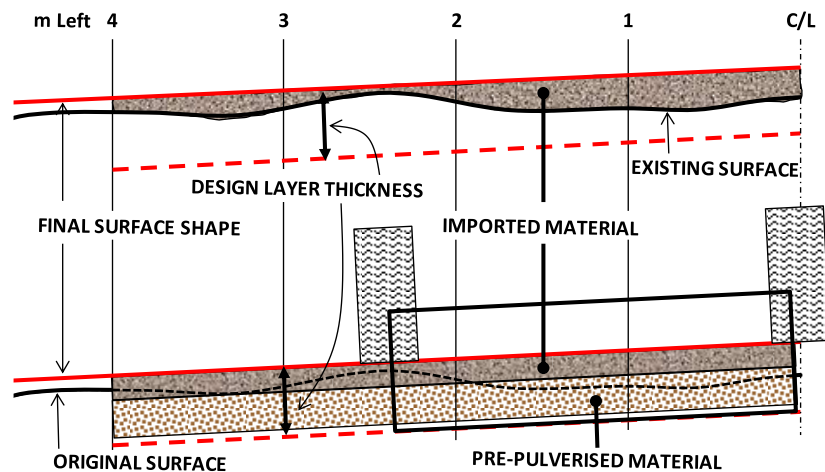

Figure 3.11 Recycling after Importing new Material

The lower part of Figure 3.11 shows the recommended method for dealing with this scenario. The material in the existing pavement should be pre-pulverised to a depth 50 mm above the bottom horizon of the new layer, spread, pre-shaped in accordance with the final levels and pre-compacted. The new material can then be imported, shaped and compacted before the recycler makes a second pass to blend the materials together by cutting to the required depth.

Imported good-quality virgin material is often used to address variability in the material encountered in the upper portion of existing pavements. Such a situation is normally only encountered with old pavements that have received numerous different maintenance interventions over the years. Imported material can be used to dilute the effects of such variability by limiting the amount of recovered material in the resulting blend. By pre-pulverising and cross-mixing the material in the existing pavement, the effect of variability is further reduced.

3.12 ALTERNATIVE DESIGNS AND ECONOMIC ANALYSES

There are always alternative solutions for rehabilitating a distressed pavement. TG2 deals solely with bitumen stabilisation and is primarily focused on treating material recovered from existing pavements. Whether a BSM

solution that involves recycling is the most appropriate option for a specific project needs to be checked by comparing it with alternative options. This requires such alternative options to be formulated followed by an economic analyses of each option.

Figure 3.12 shows an example of two different rehabilitation designs to achieve an ES10 pavement class (3 to 10 MESA). The BSM option on the left is a repeat of Figure 3.8 from Section 3.7 above. An alternative that involves recycling with cement plus the addition of a new G1 layer is shown on the right.

To determine which alternative should be adopted requires a comprehensive economic analysis, as described in Section 5 of TRH 12 (1997).

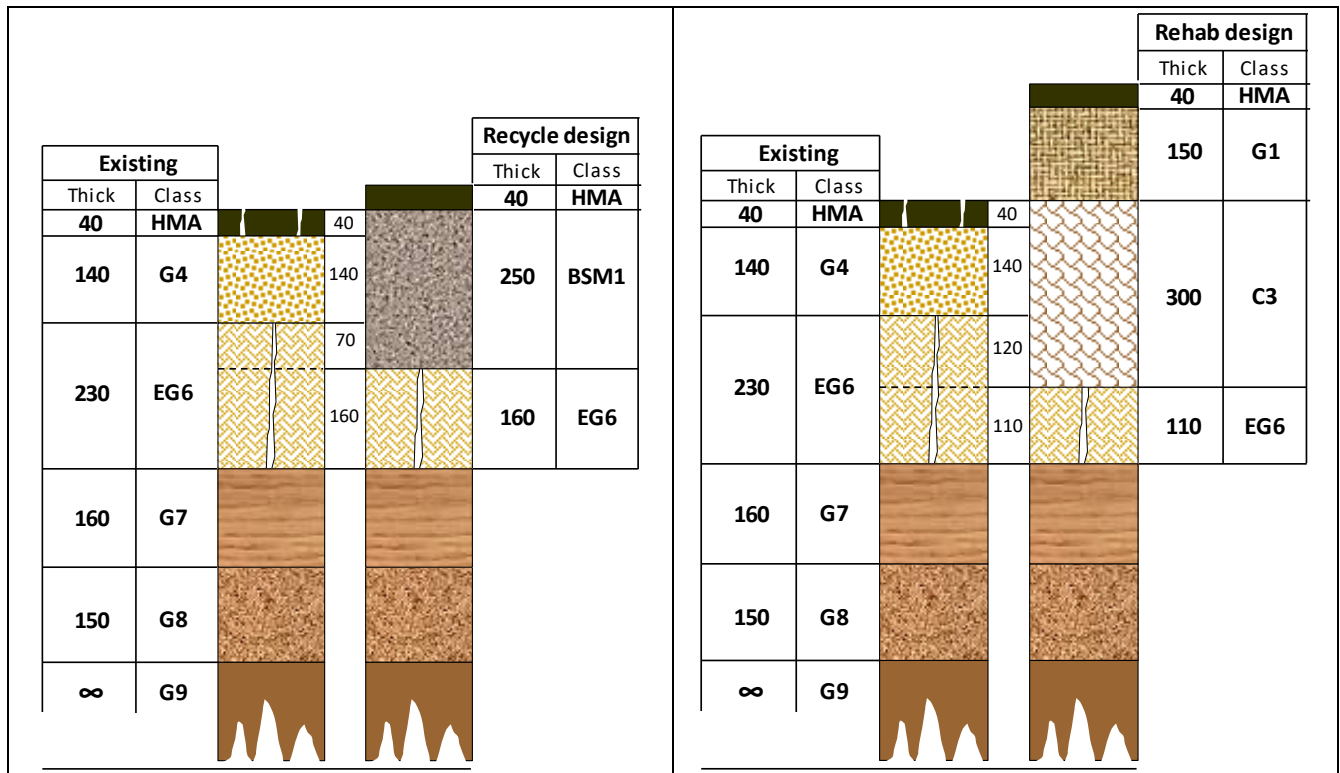

Figure 3.12 Example: Alternative Rehabilitation Designs for the Same Structural Capacity

CHAPTER 4. MIX DESIGN

Bitumen Stabilised Materials (BSMs) need to be optimally formulated to provide reliable performance. To achieve this, a mix design procedure is required to evaluate the ingredients of the BSM, i.e. aggregate, water, bitumen and active filler in different combinations. The process includes evaluation of the individual components, as well as the blended material. The intention of mix design is to formulate a composite product with the necessary quality for a specific purpose or application.

The BSM mix design procedure requires optimisation not only in terms of volumetric, workability and compactability characteristics, but also requires the consideration of engineering properties and durability. It is essential that the material samples used during the mix design are representative of the layer(s) that are intended to be recycled and stabilised with bitumen. At the same time, economic considerations remain paramount in the selection of a final mix design. The bitumen contributes significantly to the cost of BSMs, underlying the need for effective optimisation of bitumen addition content. Advances in the test methods, for example, the inclusion of triaxial testing, have enabled accurate and reliable refinements to be made of the amount of bitumen required.

Mix Design

i The intention of mix design is to formulate a composite product with necessary quality for a specific purpose or application.

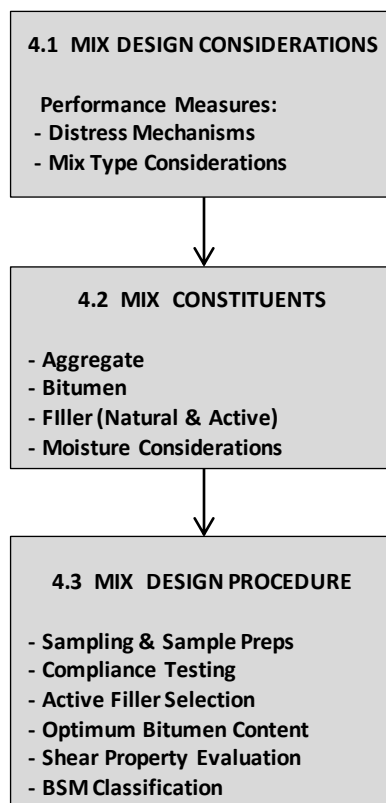

Figure 4.1 Outline of Mix Design

This chapter provides a comprehensive mix design procedure for BSMs. It introduces the key performance considerations for BSMs, followed by detailed analysis of the tests for evaluation of the characteristics of the mix components and finally provides a detailed mix design procedure, as seen outlined in Figure 4.1.

This guideline follows SANS norms (to be published), which are included in Appendix B in the interim.

4.1 MIX DESIGN CONSIDERATIONS

The flexible and durable nature of BSMs allows the materials engineer to design a base layer that is suited to the particular demands of a project. A combination of material characteristics, traffic carrying capacity and environmental influences dictates the requirements of the BSM. By varying the proportions of aggregate, bitumen and active filler in the mix, it is possible to create a layer with the necessary balance between load spreading (stiffness), rut resistance (shear strength), flexibility and durability (moisture resistance).

4.1.1 Performance Measures: Distress Mechanisms

There are two fundamental distress mechanisms that need to be considered in the mix design, namely:

- **Permanent Deformation.** This is accumulated shear deformation caused by repeated load applications and is dependent on the material's shear properties and densification achieved. Resistance to permanent deformation (rutting) is enhanced by:
 - Improved aggregate grading (continuous), angularity, shape, hardness and roughness.
 - Increased maximum particle size.
 - Improved compaction, i.e., higher field density during construction.
 - Reduced moisture content (curing).
 - Limited bitumen application, less than 3%. Higher application rates of bitumen encourage permanent deformation.
 - Addition of active filler is limited to a maximum of 1% because higher active filler contents create brittleness, which encourages shrinkage and traffic associated cracking i.e. fatigue then becomes a failure mechanism which declassifies the material from BSM status.
- **Moisture Susceptibility.** The presence of water in BSMs i.e., for compaction as well as any moisture ingress, in addition to the partially coated nature of the aggregate, makes moisture susceptibility an important consideration in the evaluation of material performance. Moisture susceptibility is a measure of the damage caused by exposure of a BSM to high moisture contents and pore-pressures caused by traffic. The damage occurs as loss of adhesion between the bitumen and aggregate leading to loss of shear strength. Moisture resistance is enhanced by:
 - Increased bitumen addition, considering the cost implications.
 - Addition of active filler, limited to 1% by mass of dry aggregate, to enhance adhesion of bitumen and aggregate.
 - Improved compaction.
 - Smooth continuous grading.

4.1.2 Mix Type Considerations

The type of BSM mix that is needed for a particular structural design is largely governed by:

- Design traffic.
- Quality of the aggregate available, including RA and blends.
- Economics.

The three main factors that determine the class and hence the quality of BSM required in the pavement structure are:

- Traffic, both volumes and vehicle loads.
- Climate, particularly moisture considerations.
- Supporting layers, whether weak or stiff.
- The class of BSM that is required will, in turn, influence mix design proportions, including bitumen and active filler addition required to achieve the standards.

The materials available for constructing BSM layers are governed by the quality of existing pavement layers, commercially available materials and blends thereof. The materials engineer should endeavour to achieve a balance between the most suitable and affordable aggregate combinations. Once this has been decided, the stabilisation agents can be considered.

The mix design for BSMs is determined by the nature and proportions of the following ingredients:

- Aggregate and its performance characteristics.
- Bitumen type (foamed bitumen or bitumen emulsion), the amount added, and compatibility with the aggregate.
- Active filler type (cement or lime) and content.

If more than 1% cement is added to BSM, the benefit of the flexibility is compromised. It is therefore recommended that mixes containing more than 1% cement are considered cement treated materials, and the TRH13 guideline is consulted for their use. TG2 is applicable to BSMs containing a maximum of 1% cement. In addition, hydrated lime can be used as an active filler, in which case lime content can be > 1%. It can be deployed to improve bitumen dispersion and adhesion to the aggregate as well as reducing the Plasticity Index of the aggregate to an acceptable level. If plasticity is the primary concern, then pretreatment of the material with lime should be undertaken before stabilisation with bitumen.

4.2 MIX CONSTITUENTS

4.2.1 Aggregate (Parent Material)

Stabilisation with either bitumen emulsion or foamed bitumen is suitable for treating a wide range of mineral aggregates. Aggregates of sound and marginal quality, from both virgin and recycled sources, have been successfully utilised in the process. It is important to note that cost-benefit considerations have led to selecting G1 to G5 and RA materials as suitable candidates for BSM. Only in exceptional circumstances, such as a lack of suitable materials, can a lesser quality parent material be justified. These materials must only be used when expert knowledge on their use is available. In addition, it is vital to adhere to the boundaries of aggregate acceptability, based on grading, PI, CBR etc, as well as recognising the differences between BSM-emulsion and BSM-foam.

The aggregate properties required for successful treatment with bitumen include durability characteristics of the natural (untreated) aggregate, as well as strength (hardness), plasticity, grading, spatial composition and the weathering characteristics.

The recommendations of engineering characteristics outlined in TRH4, TRH14 and the COTO Standard Specifications for Road and Bridgeworks, (Chapter 4: Earthworks and Layerworks: Materials, 2018) for granular materials are generally applicable to materials to be treated with bitumen. Supplementary requirements are specified below. In addition, the Materials Classification System described in Chapter 3 and Appendix B should be used to evaluate materials in an existing road.

4.2.1.1 Aggregate Source

i. Virgin Aggregate

Mineral aggregates selected for BSMs should generally meet the quality requirements of G1 to G5 materials (TRH14), depending on the levels of traffic. Poorer quality gravels, for example G6, are only considered for use in BSMs if the durability requirements in this chapter are met. The primary material properties are listed below, and specific limits for tests and indicators for the various classes of BSMs are given in Section 4.3.2.

- **Soaked CBR.**
- **Percentage passing the 0.075 mm sieve.** Higher filler contents create higher bitumen demand due to the increased surface area of particles.

- **Plasticity Index.** Plasticity is mainly attributed to the fine fraction of the aggregate. Materials with a high PI are not suitable for stabilising with bitumen. A PI upper limit of 6% is applicable to both foamed bitumen and emulsion stabilisation treatment.
- **Grading.** Sieve analyses carried out on representative samples, taken from the layers in the case of an existing road or from a material source, indicate deficiencies, especially those relating to the fines or filler content. Cohesive materials e.g. G5 or G6, should be treated with care as wet-gradings may indicate a high percentage of material passing the 0.075 mm sieve, whilst the loose filler available during full-scale mixing may be less. A comparison of the washed and unwashed gradings test carried out in the laboratory can be used to indicate the likelihood of cohesion preventing the filler from being released. The unwashed grading provides an indication of the available filler.

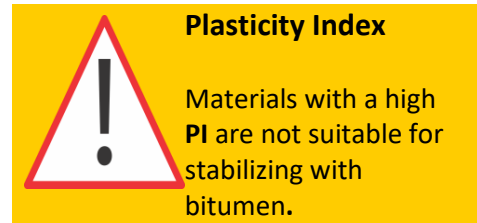

A deficiency in filler content can be addressed by adding additional fines or inert filler. Under no circumstances should cement be added to increase the filler content.

In general, the optimal grading relationship for BSM is a continuous grading defined by the equation below, where a value of $n = 0.45$ should be used.

$$P = \left[\frac{d}{D} \right]^n \cdot 100$$

where:

d = selected sieve size (mm)

P = percentage by mass passing a sieve of size d (mm)

D = maximum aggregate size (mm)

n = variable dependent on aggregate packing characteristics

Note: Aggregate sieve analysis is carried out using the washed fines method

ii. Recycled Granular Layers

As explained in Chapter 3, the quality and composition of recycled material can be highly variable and depends on:

- Structure of the existing pavement (materials and the thickness of the different layers).
- Construction variability (material quality and layer thickness).
- Depth of recycling.
- Age of the pavement (particularly with previously treated materials and materials prone to weathering).
- Extent of patching and repairs on the existing pavement.
- Thickness and nature of old surfacing layers.

iii. Reclaimed Asphalt (RA)

Rehabilitation projects sometimes encounter thick layers of asphalt that fall within the recycling horizon. This generates high percentages of RA that may require blending to supplement the grading. In such cases, the influence of the aggregate (RA) composition needs to be carefully considered in the mix design, especially with moderate to high levels of traffic. In particular, the following aspects need attention:

- **Climatic region.** If the BSM is intended for application in a warm climate, the shear properties identified through triaxial tests should be determined at representative in-service temperatures in the BSM layer. Such climates occur where PG grade for the binder in asphalt requires a High Temperature value 70 °C.
- **Axle loads.** If the BSM is intended for use in an area where overload control is not well regulated, higher stress ratios will result in accelerated deformation. This needs to be considered when analysing the shear properties.

- **RA Composition.** If the above two factors are applicable, then the composition of the RA needs to be carefully considered. If the penetration of recovered binder from RA exceeds 10 dmm and the binder appears shiny black and feels sticky, then the RA is likely to be “active”, i.e. sufficiently soft to interact with other binders, and further analysis is required, (see below). If active, the RA requires added fractions before bitumen stabilisation, for example, blending with 15% to 25% crusher dust. This will provide an angular sand skeleton that will improve the shear resistance of the mix.

A simple procedure to check the “level of activity” of the RA is as follows:

- Gently heat a representative sample of RA to 70 °C.
- Compact several 100 mm diameter specimens with 75 blows on each face using a Marshall hammer.
- Soak the specimens for 24 hours at 25 °C.
- Carry out ITS_{WET} tests following the procedure in Appendix B. Values of ITS below 100 kPa deem the binder to be inactive, while with values above 100 kPa the binder is considered to be active.

The use of 100% RA in BSMs has been successfully applied in regions of moderate climate and well-regulated axle loading.

- **Strength (hardness).** The hardness of the parent material dictates the propensity for breaking down under compaction. Since both bitumen emulsion and foamed bitumen stabilisation concentrates the bitumen on the finer fractions, additional fines generated during the compaction process, after the material has been treated, has negative consequences on both the shear properties and the moisture susceptibility.

Where the CBR of the material to be treated is less than 80% at MDD, the grading of the material should be determined before and after compacting the specimen to MDD and the results tabulated for the percentage passing the 5 mm, 2 mm, 0.425 mm and 0.075 mm sieves. The difference for each of these four sieves is determined and summed to produce the “breakdown coefficient”, as shown in Table 4.1. Where the Breakdown Coefficient exceeds 20 or the percentage passing the 0.075 mm sieve changes by 5% or more, the material should be subjected to durability testing.

Table 4.1 Breakdown Coefficient

Sieve Size (mm)	Passing Sieve Size (%)		Change (%)
	Before Compaction	After Compaction	
5	42	51	9
2	31	35	4
0.425	14	19	5
0.075	8	12	4
Breakdown Coefficient			22

- **Durability.** Durability does not apply solely to the moisture resistance of a BSM or the resistance to ageing of the bitumen in the mix. It also applies to the durability of the untreated aggregate before stabilisation. The Durability Mill Index (DMI) is the preferred test parameter for such an evaluation. This test identifies the potential durability of aggregates in terms of breakdown and generation of excessive plastic and non-plastic fines. The test has the most potential to simulate the likely breakdown of the materials in service, and is applicable to all material types. Although acceptable limits for these tests were initially applicable to granular materials only, these limits have been adapted for pretreated (parent) materials for use in the selection of component aggregates for bitumen stabilisation. The DMI limits are shown in Table 4.2.

Where materials are blended, the DMI value must satisfy the worst case requirement of the individual constituents. The DMI requirements are only applicable to material classes G5(b) and poorer. RA is excluded from DMI requirements.

Table 4.2 Durability Mill Index, Limit for Rocks and Soils

Aggregate Type	Rock and Soil Group	DMI Limit	P _{0.425} (%) after DMI
Granites, gneiss, granite	Acid Crystalline	< 420	< 35
Hornfels, quartzite	High silica		
Dolomite, limestone,	Carbonate		
Ironstone, magnesite, magnetite	Metalliferous	< 480	< 40
Calcrete, ferricrete, silcrete	Pedogenic materials		
Sandstone, siltstone, conglomerate	Arenaceous	< 125	< 35
Greywacke, tillite	Hornfels, Diamictite		
Mudrock, phillites, shale	Mudrock		
Basalt, Dolerite, Gabbro	Basic crystalline	< 80	< 35
	Argillaceous	Material not suitable	

4.2.1.2 Aggregate Temperature before Mixing

Laboratory mixes are produced with materials at a standard material temperature of 25 °C.

When lower field temperatures are anticipated during construction, the mix design should be repeated with material conditioned to such lower temperatures, within the limits described below.

BSM-Emulsion

Typically, aggregates with temperatures of 10 °C or higher can be treated with bitumen emulsion without compromising the bitumen dispersion.

BSM-Foam

Aggregate temperature prior to BSM-foam production has a significant influence on the degree of dispersion and the properties of the mix. Higher aggregate temperatures increase the size of the aggregate particle that can be coated. Temperature measurements of the aggregate are, therefore, essential before laboratory or field production commences.

Field mixing should not be attempted with aggregate temperatures less than 15 °C. Where the aggregate temperature ranges between 12 to 15 °C, mixes should only be produced with superior quality bitumen with exceptional foaming characteristics (especially the half-life) and under the supervision of a practitioner highly experienced with BSMs.

Aggregate Temperature

i Aggregates with temperatures **lower than 10 °C** should not be treated with bitumen emulsion.

Aggregate temperatures in the laboratory should match the expected field temperatures.

4.2.2 Bitumen

Penetration grade bitumen is used to produce both the foamed bitumen and bitumen emulsion that is used to manufacture BSMs. The types of bitumen and specific bitumen requirements are outlined below.

Bitumen Emulsion

- **Bitumen emulsion category.** Base bitumen with penetration values between 70 and 100 are generally selected for bitumen emulsion production, although softer and harder bitumen has been successfully used. The selection of the correct grade or category of bitumen emulsion for the application is essential, as outlined in Table 4.3.
- **Bitumen emulsion grade.** In South Africa, slow set (stable grade) anionic bitumen emulsions are almost exclusively used for BSMs as they typically work well with dense graded aggregates and with aggregates with high fines contents. Some manufacturers differentiate between “stable grade” (for Cape Seal slurry) and “stabiliser grade” (for BSM). These bitumen emulsions have long workability times to ensure good dispersion and are formulated for stability during mixing. The motivating forces in southern Africa for using this type of bitumen emulsion are economics and climate. In the rest of the world, cationic bitumen emulsions are extensively used, primarily influenced by climate.

- Breaking rate.** Bitumen emulsions used for stabilisation and cold recycling are slower setting than premix grade products, and should be used on projects where the treated layer can be allowed to cure for a period before opening to traffic. During the mix design phase, and on site before full-scale application begins, the breaking rate should be tested with representative samples of aggregate, active filler and water, at realistic temperatures.
- Compatibility of bitumen emulsion and aggregate.** The selection of the bitumen emulsion type for treatment is influenced by the type of aggregate to be treated. The guidelines outlined in Table 4.4 indicate that certain aggregates are less suitable for treatment with anionic bitumen emulsions. The aggregates listed in this table have silica contents above 65% and alkali contents below 35%, i.e. acidic rocks. In such cases a cationic bitumen emulsion could be considered. It should be noted that cationic emulsions are caustic due to the high concentration of hydrochloric, which is corrosive and may damage the pumps and spraybar components.

BSM-emulsion mixes are typically stabilised with 2.8% to 4.2% gross emulsion. This provides approximately 1.7% to 2.5% residual binder in the mix.

Table 4.3 Categories of Bitumen Emulsion for Treatment

Bitumen Emulsion Type	Anionic	Cationic
Emulsifier type	Fatty acid or resin acid	Amine
Bitumen emulsion charge	Negative	Positive
pH	High (alkali)	Low (acid)
Grades	Stable mix (slow set): recycling and treatment	

Table 4.4 Compatibility of Bitumen Emulsion Type with Aggregate Type

Aggregate Type	Compatible With	
	Anionic Bitumen Emulsion	Cationic Bitumen Emulsion
Dolerite	✓	✓
Quartzite	✗	✓
Hornfels / Greywacke	✓	✓
Dolomite	✓	✓
Granite	✗	✓
Andesite	✓	✓
Tillite	Variable	✓
Basalt	✓	✓
Sandstone	✗	✓
Rhyolite	✗	✓
Marble/Norite	✓	✓
Syenite	✗	✓
Amphibolite	✓	✓
Felsite	✗	✓

Note: Manufacturers normally recommend that undiluted bitumen emulsion is heated to between 50 and 60 °C to reduce the viscosity and ensure uniform application by the spraybar at the same time minimising the risk of blockages or premature breaking.

Foamed Bitumen

BSM-foam only requires low percentages of bitumen, typically 1.7% to 2.5%, and can utilise softer grades of bitumen without compromising the stability of the mix.

Bitumen types with penetration values between 70 and 100 are generally selected for BSM-foam, although softer and harder bitumen have been successfully used in the past and may be used when available. For practical reasons, harder bitumen is generally avoided due to an inferior quality foam, leading to poorer dispersion of the bitumen in the mix.

The penetration value alone does not qualify bitumen for use in a foamed bitumen mix. The foaming properties of each bitumen type need to be tested. Two characteristics form the basis of bitumen’s suitability for use, namely the Expansion Ratio (ER) and Half-life ($\tau_{1/2}$):

- The expansion ratio is a measure of the viscosity of the foam and determines how well the bitumen disperses in the mix. It is calculated as the ratio of the maximum volume of foam relative to the original volume of bitumen.
- The half-life is a measure of the stability of the foam and provides an indication of the rate of collapse of the foam during mixing. It is calculated as the time taken in seconds for the foam to collapse to half of its maximum volume.

Foaming Characteristics

i The **Expansion Ratio (ER)** is the maximum volume of foam relative to the original volume.

The **Half-Life ($\tau_{1/2}$)** is the time the foam takes to collapse to half of its maximum volume.

The procedure described in Appendix B, Test Method BSM1 is followed to determine the bitumen temperature and percentage of water addition that is required to produce the best foaming properties (maximum expansion ratio and half-life) for a particular source of bitumen. These properties are measured at three different bitumen temperatures in the range of 160 °C to 190 °C. The interpretation of the foaming characteristics is outlined in Figure 4.2. The percentage water addition and temperature that produces the best foaming properties is adopted for use in all the procedures that follow. Minimum limits for ER and ($\tau_{1/2}$) are given in Table 4.5.

One of the dominant factors influencing the foaming properties is the application rate (%) of water injected into the expansion chamber to create the foam. As illustrated in Figure 4.2, a higher application rate of water into the hot bitumen creates greater expansion (higher ER) but leads to more rapid subsidence or decay, i.e., a shorter half-life ($\tau_{1/2}$). The water application rate and bitumen temperature are the most important factors influencing foam quality. An increase in bitumen temperature usually improves foam quality. Test Method BSM1 in Appendix B describes the procedure for measuring the foam properties for different application rates of water and at different temperatures. This includes sensitivity analysis of foaming characteristics versus water application rate.

As with storage, handling and application of all bituminous products, temperature and time limits should be implemented to prevent damage to the bitumen.

The variability of the foam characteristics measured in a laboratory, both in terms of repeatability and reproducibility, is significant. To attain an acceptable level of statistical reliability, at least three tests are recommended for each set of conditions, as described in Test Method BSM1 in Appendix B. In addition, potential variability in the bitumen composition from the same source necessitates checking the foaming characteristics of each batch produced by refineries.

Table 4.5 Foaming Characteristic Limits

Aggregate Temperature	15 °C to 25 °C	> 25 °C
Expansion Ratio, ER (times)	≥ 10	> 8
Half-life, $\tau_{1/2}$ (secs)	≥ 8	≥ 6

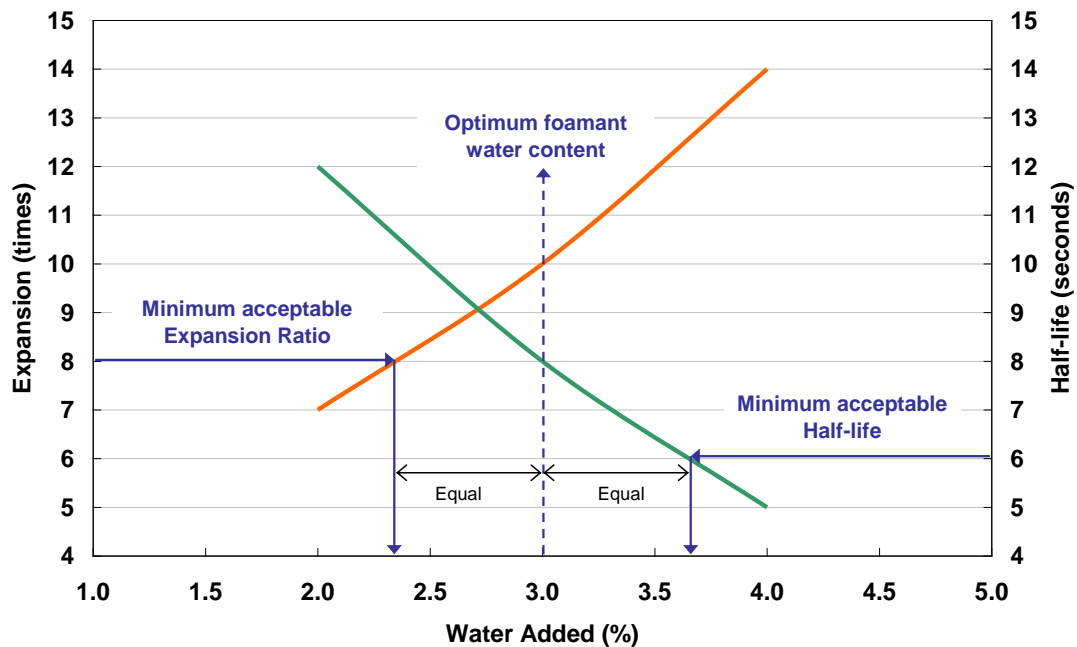

Figure 4.2 Determination of Foam Characteristics: Optimum Water Addition to Hot Bitumen

4.2.3 Filler (Natural and Active)

The types of filler used with BSMs are: cement (various types, but not rapid hardening cements), lime, rock flour, fly ash and slag. For the purpose of this guideline, the term active filler is used to define fillers that chemically alter the mix properties. This includes fillers such as lime, cement and fly ash, but excludes natural and inert fillers, such as rock flour. In this guideline, lime always refers to hydrated lime.

The purpose of incorporating active filler in BSM is to:

- Improve adhesion of the bitumen to the aggregate.
- Improve dispersion of the bitumen in the mix.
- Modify the plasticity of the natural materials (reduce PI).
- Increase the stiffness of the mix and rate of strength gain.
- Accelerate curing of the compacted mix.

Active Filler

i The term active filler is used to define fillers that **chemically alter** the mix properties.

Active filler also assists to control the breaking time when stabilising with bitumen emulsion.

Various types of active filler can be used, either separately or in combination. The filler type selected for application depends on availability, cost and efficacy with the specific materials being treated. Research and experience have shown that it is almost impossible to predict which active filler will prove to be the most effective without trial tests during mix design. Indirect Tensile Strength (ITS_{WET}), is used as a guide for active filler selection.

When lime and cement is used in BSM, the application rate must be limited to a maximum of 1% by mass of dry aggregate. When the Plasticity Index of the aggregate is above 6%, it is possible to pretreat the material with hydrated lime to modify the mix and reduce the plasticity. In such cases the application rate of lime may be increased to 1.5% or more. Caution needs to be exercised regarding the lime addition with materials containing amorphous silica as the pretreatment can result in excessive strength and mix stiffness (e.g. ITS_{DRY} well in excess of 300 kPa). This results in a loss of flexibility of the material as the active filler dominates the bitumen's contribution to durability.

Lime and Cement

When **lime** or **cement** is used in BSM, the application rate must be limited to a maximum of 1% by mass of dry aggregate.

Where cement is applied as an active filler, the time delay between mixing the cement with the material and application of the foamed bitumen or bitumen emulsion should be reduced to a minimum both in the laboratory and the field. The hydration reaction begins immediately upon contact with moist material, promoting adhesion between the fine particles. The longer the delay between premixing with cement and applying the bitumen, the lower the percentage of filler available for dispersion of the bitumen in the BSM mix. This principle applies to stockpiling BSM. For materials that will be stockpiled, it is recommended that lime is used as the active filler.

Where materials with unacceptably high PI values are encountered, they can be treated with hydrated lime to modify the plasticity, thereby rendering them acceptable for treatment with foamed bitumen or bitumen emulsion. When pretreating with lime, sufficient time must be allowed for modification to take place before bitumen treatment. Depending on the material type, 4 hours or more may be necessary for effective lime modification.

4.2.4 Moisture Considerations

4.2.4.1 Mixing and Compaction Moisture

The role of moisture in the aggregate is similar for BSM-emulsion and BSM-foam in many respects, but there are some differences. The entire fluid content in the mix, moisture and bitumen, needs to be considered. The role of moisture in the two types of BSM is explained in Table 4.6.

Table 4.6 Role of Fluids in BSMs

Component	BSM-Emulsion	BSM-Foam
Bitumen	Contributes to fluids for compaction	Negligible contribution to fluids for compaction
Moisture in aggregate	Reduces absorption of bitumen emulsion water into aggregate	Separates and moistens fines making them available for bitumen adhesion during mixing
	Prevents premature breaking	Provides the moisture for bitumen dispersion
	Extends breaking and curing time. Also reduces early strength	Reduces early strength
	Provides workability of BSM for placement and spreading at ambient temperatures by reducing the friction angle. In addition, it provides lubrication for compaction	Provides shelf-life for the mix

BSM-Emulsion

Changes in moisture content occur in two distinct phases, namely curing and breaking.

Breaking is the separation of the bitumen from the water phase through flocculation and the coalescence of the bitumen droplets to produce films of bitumen on the aggregate. The interval after which the bitumen droplets separate from the water phase and coalesce, is referred to as the breaking or setting/settling time.

The breaking process with anionic bitumen emulsions is a mechanical process (evaporation), whereas cationic bitumen emulsions produce a chemical break. For dense mixtures, more time is needed to allow for mixing and placement, and slower breaking times are required. As the bitumen emulsion breaks, the colour changes from dirty brown to black. Although this can be observed with the naked eye, it is recommended that a magnifying glass is used.

Curing is the displacement of water and resultant increase in stiffness and tensile strength of the material. This is important as a mix needs to acquire sufficient stiffness and cohesion between particles before carrying traffic.

Some of the factors which influence the whole setting process (breaking and curing of bitumen emulsions) include:

- Rate of absorption of water by the aggregate. Rough-textured and porous aggregates reduce the breaking and setting time by absorbing water contained in the bitumen emulsion.
- Moisture content of the mix prior to mixing influences breaking time.

- Moisture content of the mix after compaction influences curing rate.
- Grading of the aggregate and voids content of the mix.
- Type, grade and quantity of the bitumen emulsion.
- Mechanical forces caused by compaction and traffic.
- Mineral composition of the aggregate. The rate of cure may be affected by physicochemical interactions between the bitumen emulsion and the surface of the aggregate.
- Intensity of electrical charge on the aggregate in relation to that of the bitumen emulsion.
- Active filler percentage, the amount of cement or lime.
- Temperature of aggregate and air. The higher temperature, the quicker the bitumen emulsion breaks and cures.

A minimum of 1 to 2% moisture is required in the aggregate prior to adding the bitumen emulsion. The water and bitumen in the bitumen emulsion act as lubricants for BSM-emulsion mixes. The optimum fluids content (OMC) based on MDD should be determined for the total mixing fluid content. This is explained in following equation:

$$OFC = FMC + EWC + RBC$$

where:

OFC = optimum fluids content (%)

FMC = field moisture content of the aggregate (%)

EWC = emulsion water content (%)

RBC = residual bitumen content as percentage of dry aggregate (%)

The required moisture content for laboratory compaction is OFC. The determination of OFC is outlined in Appendix B, Test Method BSM2: Laboratory Mix Design of Bitumen Stabilised Material.

BSM-Foam

For in-plant and in situ recycling, the moisture content of the material needs to be between 60 and 75% of the optimum moisture content (OMC) (from MDD compactive energy) during mixing and applying the foamed bitumen. This corresponds to the fluff point moisture content, i.e., the moisture content at which the maximum bulk volume of loose material is obtained.

The required moisture content for laboratory compaction is OMC.

4.2.4.2 Water Quality

The quality of the water used to create the foamed bitumen and bitumen emulsion is important to ensure a mix of reliable quality. The standard COTO requirements should be followed in this regard.

BSM-Emulsion

The pH levels of the water must be checked, as must the compatibility of the bitumen emulsion and the water. These checks are done by performing a dilution test.

Dilution "can" test

The bitumen emulsion is diluted to specification, in a clean container such as a can. To prevent premature breaking, water is always added to the bitumen emulsion, not bitumen emulsion to water. The "can" is then heated to 60 °C, and left to stand for 20 to 30 minutes. The diluted bitumen emulsion is then passed through a 0.600 mm sieve to determine if any premature breaking has taken place, reflected by the residue on the sieve.

Note: The dilution water for cationic bitumen emulsion must not be alkaline; dam water can be alkaline especially in limestone areas. For a cationic bitumen emulsion, the addition of hydrochloric acid to the water reduces this tendency. For anionic bitumen emulsion, the dilution water must not be acidic. Lime or caustic soda is added to the dilution water, if necessary.

BSM-Foam

Although acceptable foam may be achieved using water containing impurities, such practice should be avoided. Impurities often lead to scales forming on the walls of the pipes feeding water to the expansion chambers. These eventually dislodge and block the water injection jets, preventing the bitumen from foaming.

4.3 MIX DESIGN PROCEDURE

The mix design of BSMs entails a process to ensure both reliable performance and the determination of a cost effective mix composition. It comprises sampling and characterisation of component materials, followed by mixing, compaction, curing and testing.

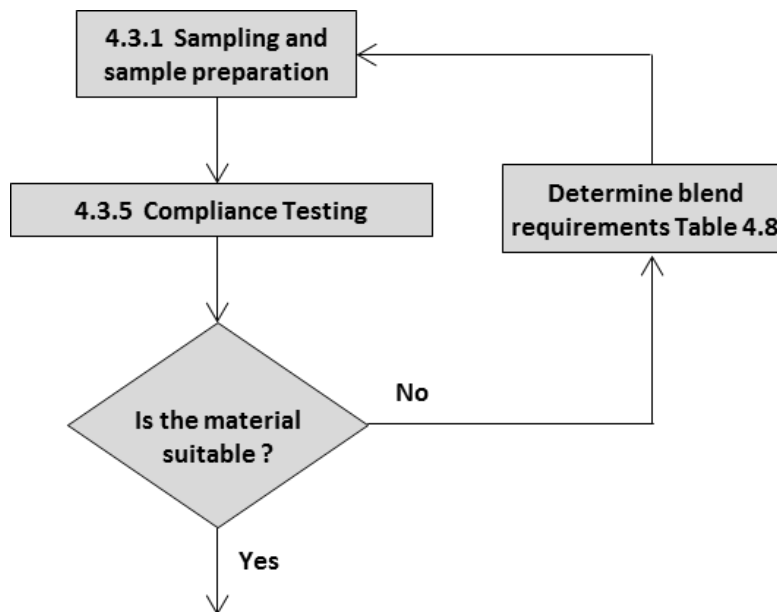

Figure 4.3 Sample and Preliminary Tests for Characterisation

4.3.1 Sampling and Sample Preparation

The information provided in the section can be supplemented by Sabita Manual 37 / TMH 5: *Sampling Methods for Road Construction Materials*.

4.3.1.1 Field Sampling

Bulk samples are obtained from test pits excavated as part of the field investigations, or from borrow pits and quarries where fresh materials are to be imported and stabilised. Each layer in the upper pavement (± 300 mm) must be sampled separately. Typically 200 kg of material or more must be recovered from each layer likely to be included in the recycling horizon. The amounts recovered from each layer are influenced by layer thickness and blending ratio. Refer to Appendix B for more information on the overall sample needed for a full BSM mix design.

4.3.1.2 Standard Soil Tests

Carry out the following standard tests on the material sampled from each individual layer or source:

- Sieve analysis to determine the grading (fines washing procedure, SANS 3001-GR1)
- Atterberg limits to determine the plasticity index (SANS 3001-GR10)
- Moisture / density relationship for OMC and MDD (SANS 3001-GR30)

4.3.1.3 Sample Blending

Where recycling is considered, it is possible to blend the materials sampled from the different layers (and/or new material) to obtain a combined sample representing the material from the full recycling depth. The in situ density of the various component materials must be considered when blending materials, as illustrated in Figure 4.4.

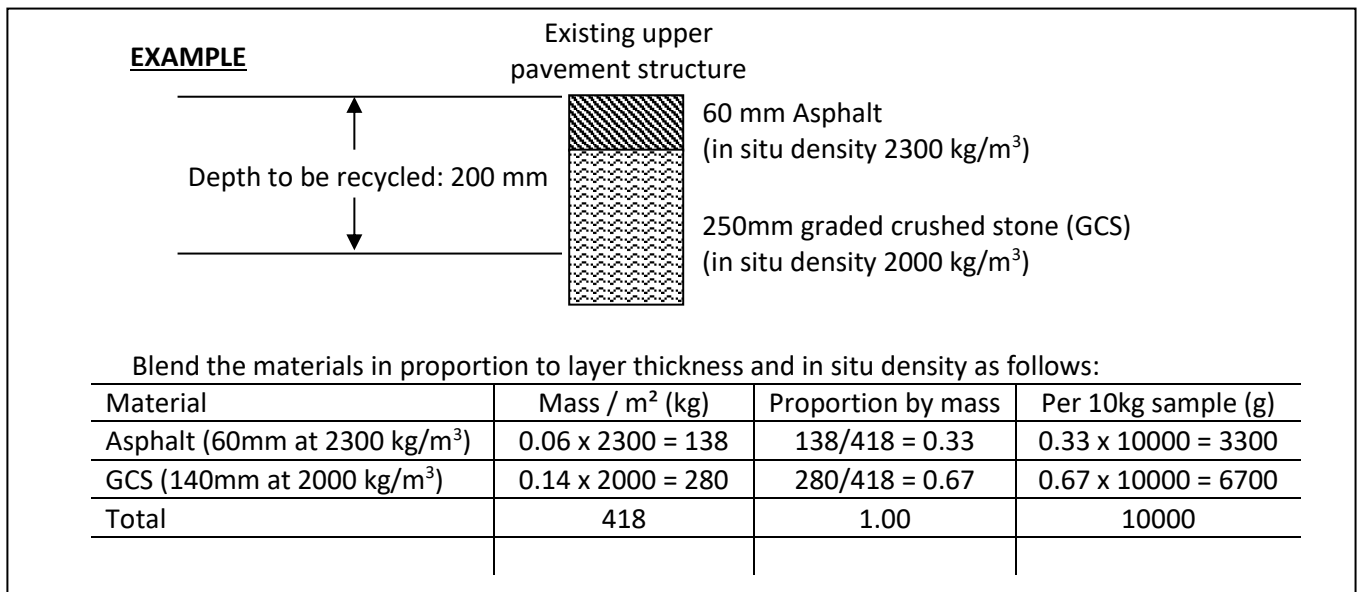

Figure 4.4 Example of Blending Exercise

The standard soil tests listed in Section 4.3.1.2 above must be repeated to determine the grading, plasticity index and the moisture / density relationship of the blended sample.

4.3.1.4 Gradings (Sieve Analyses)

Plot the grading curve for the sample that will be used in the mix designs. Include on the graph the “Recommended gradings” envelope from the Table 4.7. This plot indicates whether additional blending with freshly imported material may be required. However, if the plot includes a gap in the fractions between the 0.075 mm and 2.0 mm sieves, as shown by the red line and legend title “Avoid” in Figure 4.5, the sample should be blended with a sufficient suitable fine material, e.g., 10% by volume of < 5 mm crusher dust, to reduce the magnitude of the bulge.

This exercise is advisable as it allows a preliminary indication of performance after the material has been treated. A poorly graded material is difficult to compact and the consequent low density achieved will significantly affect the strength, especially under saturated conditions.

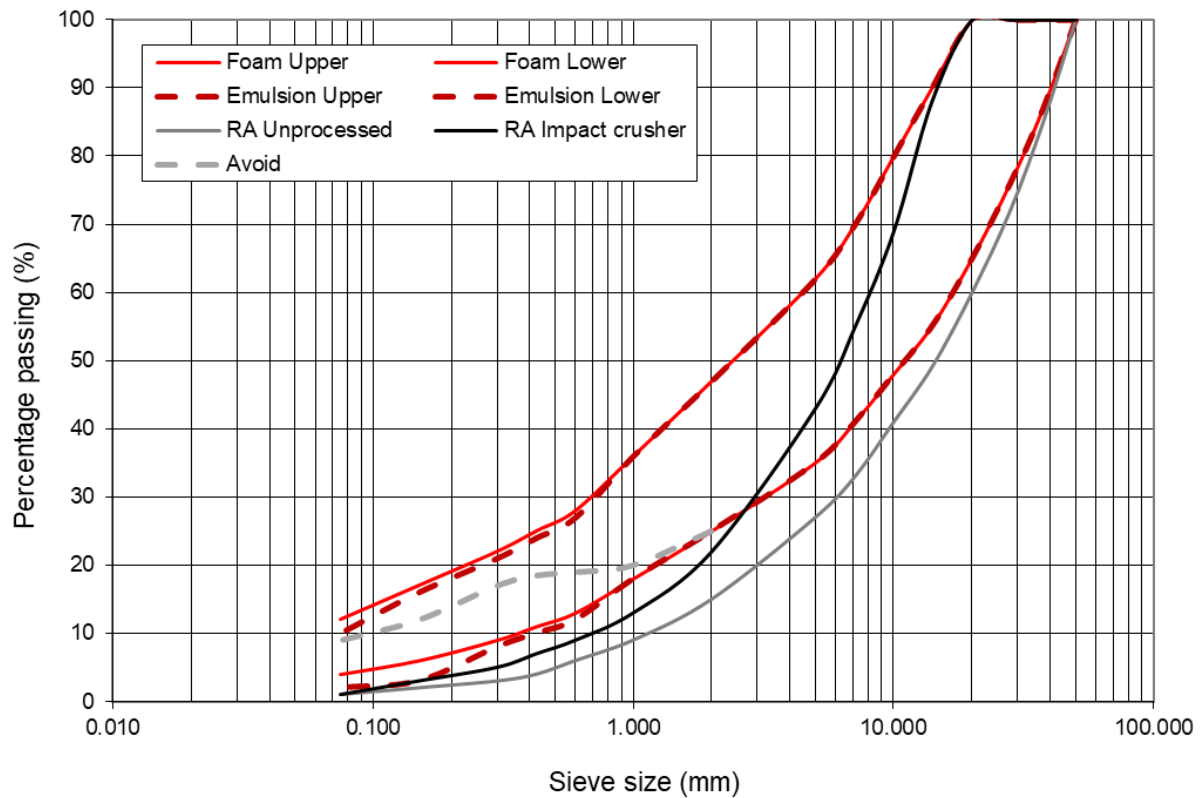

Figure 4.5 Gradings for BSM-Emulsion, BSM-Foam and RA

Table 4.7 Recommended Grading for BSM-Foam and BSM-Emulsion

Sieve size (mm)	Percentage passing each sieve size (%)			
	Target gradings BSM-Foam	Target gradings BSM-Emulsion	Grading for BSM-Foam and BSM-Emulsion, with > 50% RA	
	Upper & Lower Limits	Upper & Lower Limits	Unprocessed	Impact crushed
50	100	100 – 100	100	100
37.5	87 – 100	87 – 100	85	100
28	76 – 100	76 – 100	72	100
20	65 – 100	65 – 100	60	100
14	55 – 100	55 – 100	49	88
10	47 – 89	48 – 89	41	69
7.1	40 – 78	41 – 78	33	55
5.0	34 – 68	35 – 68	27	43
2.0	22 – 48	25 – 48	15	22
1.0	15 – 37	18 – 37	9	13
0.6	11 – 30	12 – 30	6	9
0.425	9 – 26	10 – 26	4	7
0.3	7 – 22	8 – 22	3	5
0.15	5 – 17	3 – 15	2	3
0.075	4 – 14	2 – 10	1	1

Note: Where recycled materials comprise RA content > 50%, stabilisation with emulsion should not include rejuvenators nor soft recovered binders in the RA. The penetration should be checked to ensure that the recovered binder is “not active” i.e. Recovered Pen > 10 dmm, sticky and viscous.

4.3.1.5 Representative Proportioning

To proportion materials representatively, separate the material in the prepared bulk sample into the following four fractions:

- i. Retained on the 20.0 mm sieve
- ii. Passing the 20.0 mm sieve, but retained the 14.0 mm sieve
- iii. Passing the 14.0 mm sieve, but retained on the 5.0 mm sieve
- iv. Passing the 5.0 mm sieve

Reconstitute the representative samples in accordance with the design (target) grading above (for the bulk sample) for the portion passing the 20.0 mm sieve. Substitute the portion retained on 20.0 mm sieve with material that passes the 20.0 mm sieve and is retained on the 14.0 mm sieve. The example in Table 4.8 explains this procedure.

Table 4.8 Example of Reconstituting a Representative Sample

Sieve Analysis		Quantity of Material to be Included in a 10 kg Sample		
Sieve size (mm)	Percentage Passing ¹	Passing 4.75 mm	Passing 13.2 mm and retained on 4.75 mm	Passing 19.0 mm and retained on 13.2 mm
20.0	90.5	$(53.6/100 \times 10000)$ = 5.360 g	$((72.3-53.6)/100 \times 10000)$ = 1.870 g	$((100-72.3)/100 \times 10000)$ = 2.770 g
14.0	72.3			
5.0	53.6			

Note: 1. From sieve analysis on bulk sample.

Note that the portion retained on the 20 mm sieve (9.5% in the example in Table 4.8) is replaced with the same mass of material that passes the 20 mm sieve, but is retained on the 14 mm sieve. The material retained on the 20 mm sieve may be lightly crushed to pass through the 20 mm sieve. The portion of this crushed material retained on the 14 mm sieve can be used as substitute material.

4.3.1.6 Hygroscopic Moisture Content

Two representative air-dried samples, each approximately 1 kg, are used to determine the hygroscopic (air-dried) moisture content of the material following the standard test procedure for moisture determination. Note that a larger sample size should be used for more coarsely-graded materials.

4.3.2 Mixing

BSM-Emulsion

Blender-type laboratory mixers and flat-pan mixers with a rotary mixing motion are suited to mix preparation for BSM-emulsion. Care should be taken to ensure that bitumen does not remain on the mixing drum or paddles, as this influences the final bitumen content.

The moisture content during laboratory mixing needs to be considered in 2 phases:

- Phase 1: Add water (optimum fluid content minus gross emulsion content) to the material plus active filler and mix for 30 seconds without adding emulsion.
- Phase 2: Add emulsion and mix for 45 seconds.

BSM-Foam

The mixing process for BSM-foam is a dynamic one as the foamed bitumen begins to collapse rapidly once in contact with the unheated aggregate. Different mixers can produce discrepancies of up to 25% in material strength properties. It is imperative, therefore, to utilise a laboratory foaming plant and mixer that emulates site mixing as detailed below.

Blender type laboratory mixers do not emulate this, and subsequently the quality of laboratory mixes is usually inferior to site mixes. For this reason, a twin-shaft pug-mill type mixer must be used in the laboratory. A mixing time of 30 seconds is used in the laboratory, which is longer than in situ mixing but simulates the differences in the energy of the laboratory mixer and field plant.

The moisture content during laboratory mixing needs to be considered in 3 phases:

- **Phase 1:** Add 75% of OMC (i.e. fluff point moisture) to the material plus active filler and mix for 30 seconds, before adding foamed bitumen.
- **Phase 2:** Add foamed bitumen and mix for 30 seconds.
- **Phase 3:** Add remaining 25% of OMC and mix for a further 30 seconds.

4.3.3 Compaction

The procedure for manufacturing test specimens using a vibratory hammer is explained in Appendix B, Test Method BSM3. The vibratory hammer of specified point energy, weight and frequency, simulates field compaction of these materials more closely than falling weight devices, presses or gyratory compactors.

A vibratory hammer is used to compact the BSM specimens in a split-mould to MDD target density (SANS 3001 Test Method-GR30). The moulds differ for ITS and triaxial specimens.

4.3.4 Curing

The curing procedure for BSM-foam and BSM-emulsion is identical. However, a difference in curing is required for ITS specimens and triaxial specimens, owing to the geometric differences, i.e. both specimens are 150 mm diameter but the ITS is 95 mm high versus the 300 mm high triaxial specimens.

ITS specimen curing

Six specimens of 152 mm in diameter and 95 mm high are manufactured for each mix composition in the mix design. The variables of each mix include:

- Bitumen type (foam versus emulsion)
- Active filler type (cement or lime or none)
- Bitumen application rates (four percentages)

The procedure for curing specimens is summarised below. The detailed procedure is described in Appendix B, Test Method BSM4.

- Once the specimens have been extracted from their respective moulds and marked, they are placed in a forced draft oven at a temperature of 40 °C (± 1 °C) and a minimum period of 72 hours (3 days). The curing of ITS specimens yields the “Dry” condition for testing. This differs from triaxial specimens.
- After 72 hours, remove the specimens from the oven and weigh each one, recording their individual mass.
- Return all the specimens to the oven at 40 °C for a further 4 hours and repeat the weighing exercise. If the mass of any specimen reduces by more than 10 g, place all the specimens back in the oven for a further 24 hours. This procedure is repeated as many times as is necessary until the specimens achieve constant mass.
- The specimens are then left to cool to a constant temperature of 25 °C (± 2 °C). After cooling for a minimum time of 20 hours, determine the bulk density of each specimen.
- Exclude from testing any specimen with a bulk density that differs from the mean bulk density of all six specimens by more than 2.5%.
- Place half of the specimens under water in the soaking bath for 24 hours at 25 °C (± 2 °C). After soaking, remove the specimens from the water, surface dry and test immediately.

Triaxial specimen curing

Ten specimens, 150 mm in diameter and 300 mm high are manufactured for each test following the procedure for manufacturing test specimens using vibratory hammer compaction at OMC_{MDD} , as described in Appendix B, Test Method BSM3.

- Leave all ten specimens overnight in their respective moulds covered with a moist hessian cloth.
- The following morning, remove the specimens from their respective moulds, mark each one with an appropriate identity number and determine the bulk density of each specimen.
- Calculate the mean and standard deviation of the bulk density for all ten specimens and determine if any of the specimens are outliers that must be excluded from further testing. If more than two specimens are excluded then the test must be abandoned, as detailed in the test method.
- Place the specimens in a forced draft oven at a temperature of $40\text{ }^{\circ}\text{C} (\pm 1\text{ }^{\circ}\text{C})$ for a period of 8 hours. After 8 hours, remove all specimens from the oven, place each in a loose-fitting plastic bag, seal the bags and return the specimens to the oven at $40\text{ }^{\circ}\text{C} (\pm 1\text{ }^{\circ}\text{C})$ for a further 48 hours. This curing of the triaxial specimens yields an “Equilibrium” condition for testing.
- Take the specimens out of the oven after 48 hours. Remove two of the specimens from their plastic bags and place under water in a soaking bath for 24 hours. Ensure that the specimens are submerged with at least 25 mm of water covering the top faces.
- Place the remaining specimens in fresh (dry) plastic bags, seal and leave to cool to $25\text{ }^{\circ}\text{C} (\pm 2\text{ }^{\circ}\text{C})$ for a minimum cooling period of 12 hours. The specimens are only removed from their plastic bags and weighed immediately before testing.
- Remove the soaked specimen(s) from the water after soaking for 24 hours, surface dry and weigh before testing.

The recommended minimum sample sizes for each of the mix design tests are provided in Table 4.9.

Table 4.9 Sample Size Requirements for Mix Design Tests

Test	Mass of Sample Required (kg)
Moisture / density relationship (modified AASHTO T180)	40
Standard soil tests (gradings, Atterberg Limits, moisture content, etc.)	20
Determination of active filler requirement (18 specimens, 152 mm ϕ x 95 mm)	75
Optimum bitumen addition determination (24 specimens, 152 mm ϕ x 95mm)	75
Determination of the shear properties (10 specimens, 150 mm ϕ x 300 mm)	125

4.3.5 Compliance Testing

In addition to the grading analysis, Atterberg Limits and MDD a series of bitumen tests are required to determine the basic characteristics for classification purposes:

- Bitumen emulsion: the charge (anionic or cationic) and the stability
- Foamed bitumen: the penetration grade and foaming characteristics

The aggregate and bitumen test results are used to evaluate compliance for bitumen stabilisation. A summary of the BSM components’ minimum requirements is provided in Table 4.10.

Table 4.10 BSM Component Requirements for Classification

BSM Class	BSM 1		BSM 2	
	Foam	Emulsion	Foam	Emulsion
Binder type	Foam	Emulsion	Foam	Emulsion
Class (untreated)	G4 (A or B)		G5 (A or B) and G6*	
Grading for BSM	See Table 4.7			
P0.075 (%) [Granular > 50%]	> 4%	> 2%	> 4%	> 2%
P0.075 (%) [RA > 50%]	> 1%	> 1%	> 1%	> 1%
P0.075 (%) [Maximum for all]	< 10%			
Durability DMI	See Table 4.2			
Plasticity Index PI (%)	< 6%		< 8%	
Aggregate Mixing Temperature (°C)	> 15	> 10	> 15	> 10
Target Density (kg/m ³)	100% MDD		98% MDD	
Bitumen requirements	Expansion Ratio > 8		Half-life > 6 secs	
Active filler requirements	Cem II (32.5) or hydrated lime			

Note: Durability requirements: G6 or DE-G6 can be considered for BSM2 if it meets the natural material requirements as well as DMI requirements, see Table 4.2. DMI testing is mandatory for material classes of G5 (B) and poorer or a breakdown coefficient greater than 20%, see Table 4.1

4.3.6 Active Filler Selection

The evaluation of stabilising agents (active filler and bitumen) is determined through ITS testing. The specification values for the two classes of BSM are given in Figure 4.6. As noted in the flow chart, the first part includes evaluation of the effect of active filler.

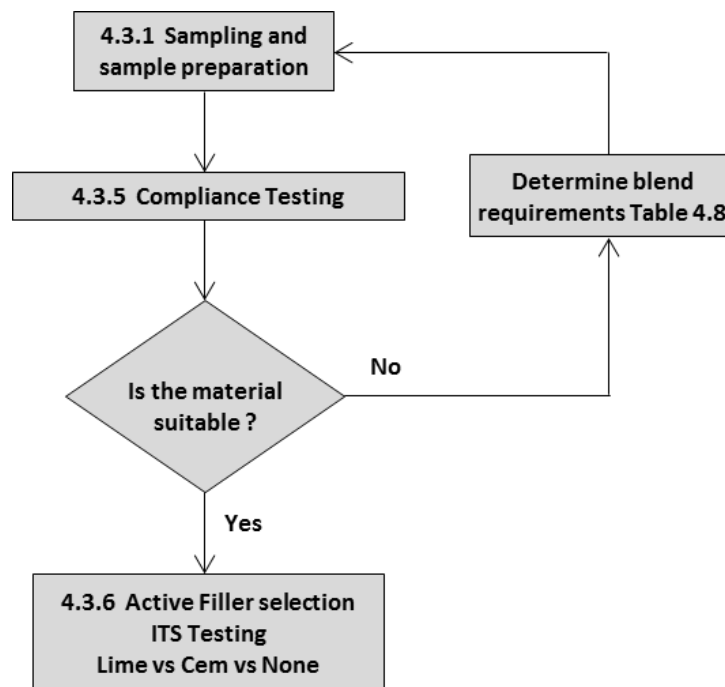

Figure 4.6 Selection of Active Filler

The recommended limits for its test results are provided in Table 4.11. The selection of active filler type is generally biased towards compliance of the ITS_{WET} value; however, all test results should be taken into consideration.

Table 4.11 Indirect Tensile Strength Limits for Classification

Class	ITS Limits	
	ITS _{DRY} (kPa)	ITS _{WET} (kPa)
BSM1	> 225	> 125
BSM2	> 175	> 100

The need for an active filler and the type of active filler (cement or hydrated lime) that is appropriate for the material is determined through ITS testing of three different mixes made from the same sample. The amount of bitumen added to each of the three mixes is the same for each. The fractions passing the 4.75 mm and 0.075 mm sieves are used as a guideline:

Three samples with the target grading, of approximately 15 kg each, are prepared at the correct moisture content. The samples are used to produce three mixes, each with the same (nominal) application rate of bitumen stabilising agent, as determined from Table 4.12, but with active filler as a variable. Mix 1 has no active filler, Mix 2 includes 1% cement and Mix 3 has 1% hydrated lime. Mixing equipment compliant with the guideline specifications in this chapter is used to produce the BSM-foam and BSM-emulsion mixtures.

Table 4.12 Guidelines for Estimating Nominal Bitumen Addition

Fraction Passing 0.075 mm Sieve (%)	Bitumen Addition (% by mass of dry aggregate)		Typical Material Types
	Fraction Passing 4.75 mm Sieve		
	< 50%	>50%	
< 4	2.0	2.0	Recycled asphalt (RA)
4 – 7	2.2	2.4	Recycled asphalt Graded crushed stone
7 – 10	2.4	2.8	Natural gravel Blends
> 10	2.6	3.0	Gravels Sands

Six 150 mm diameter x 95 mm high specimens are manufactured for each of the three mixes using vibratory hammer compaction.

After manufacture, the specimens are cured and tested in accordance with the test procedure for determining the indirect tensile strength (ITS) of BSMS. The ITS_{DRY} and ITS_{WET} values thus determined for each mix are used as the primary indicators for whether an active filler is required, and which active filler should be used (cement or lime).

The active filler that produces the highest ITS_{WET} value, i.e., either cement or hydrated lime, indicates greater compatibility to the mix components and is used in the subsequent mixes that follow. If the ITS_{WET} values for both active fillers are of the same order (difference < 5%), then either type of active filler may be selected.

Note: In order to determine the sensitivity of the mix to active filler content, additional ITS tests may be undertaken using the preferred active filler at a lower application rate (e.g. 0.5% and 0.75%). However, to avoid compromising the flexibility of the mix, the maximum allowable application rate for active filler is 1.0%. This is not applicable to hydrated lime that is used for pretreatment of plastic material, in which case the lime is considered as a separate a modifier.

The example in Table 4.13 shows:

- Hydrated lime is the preferred active filler (see ITS_{WET} values)
- Active filler does not have a significant influence on dry strength (see ITS_{DRY} values)

Table 4.13 Example of Active Filler Type Determination

Additives/Tests	Unit	Quantities		
Bitumen Addition	%	2.2	2.2	2.2
Type/amount of active Filler	%	1% Lime	None	1% Cement
Moulding Moisture Content	%	8.5	8.4	8.5
Test Result				
ITS _{DRY}	kPa	267	243	259
Moisture content at break	%	2.5	2.4	2.5
Dry density	kg/m ³	2 248	2 257	2 248
Temperature at break	°C	24.9	25.1	24.9
Displacement	mm	2.3	2.1	1.7
ITS _{WET}	kPa	150	127	76
Moisture content at break	%	6.1	6.3	6.1
Dry density	kg/m ³	2 247	2 254	2 247
Temperature at break	°C	25.0	24.9	25.0
Displacement	mm	3.1	2.8	2.3

4.3.7 Optimisation of Bitumen Application

Once the selection of active filler has been made the required amount of bitumen to meet the classification requirement is determined, see Figure 4.7. ITS testing of mixes with different bitumen contents i.e., a sensitivity analysis, is carried out. Three samples of approximately 15 kg each are then prepared at the correct moisture content, each with 1% of the preferred active filler. A different application rate of bitumen stabilising agent is then added to each mix, relative to the same nominal rate used in the first stage:

- Nominal bitumen application rate minus 0.4%
- Nominal bitumen application rate minus 0.2%
- Nominal bitumen application rate plus 0.2%

The same procedure described in Section 4.3.3 is then followed, with six specimens prepared for each mix, to determine the ITS_{DRY} and ITS_{WET} based on 3 repeat tests for each. The amount of added bitumen that meets both the ITS_{DRY} and ITS_{WET} classification requirement is selected as the optimum bitumen application rate. That bitumen content provides both adequate strength and the maximum reduction in moisture susceptibility.

The respective results of the ITS_{DRY} and ITS_{WET} tests are plotted against added bitumen content together, as part of the evaluation process. The individual ITS test results (3 repeats per mix and condition), give insight into variability and “goodness of fit”. This is demonstrated in Figure 4.8.

The plot of ITS results against added bitumen content provides the trend of ITS_{DRY} and ITS_{WET}. The inclusion of individual data points, i.e., three repeats for each condition and mix, gives insight into the variability of the results. At the same time, the specification limits are plotted on the graph, in this case for a BSM1 class material. The interpretation is a logical process:

- Taking account of variability, the ITS_{DRY} results indicate that 2.05% added bitumen will suffice.
- Taking account of variability, the ITS_{WET} results show that 2.18% added bitumen is required.

In conclusion, allowing for practically achievable tolerances, an application rate of 2.2% bitumen is selected.

Additional sensitivity tests

Additional ITS tests using the procedure described above should be considered for materials that respond effectively to lower application rates of active filler i.e. < 1%. This includes determining the effect of reducing the application rate of active filler, typically to 0.5% and 0.75%. Note that the tolerance of in-plant recycling equipment can support application rates below 1.0% active filler. It is also, however, unrealistic to expect in situ recyclers to achieve a uniform mix of active filler that is applied below 1.0% for bulk spreaders and 0.7% for purpose-built spreaders with cellular wheels controlled by on-board micro-processors

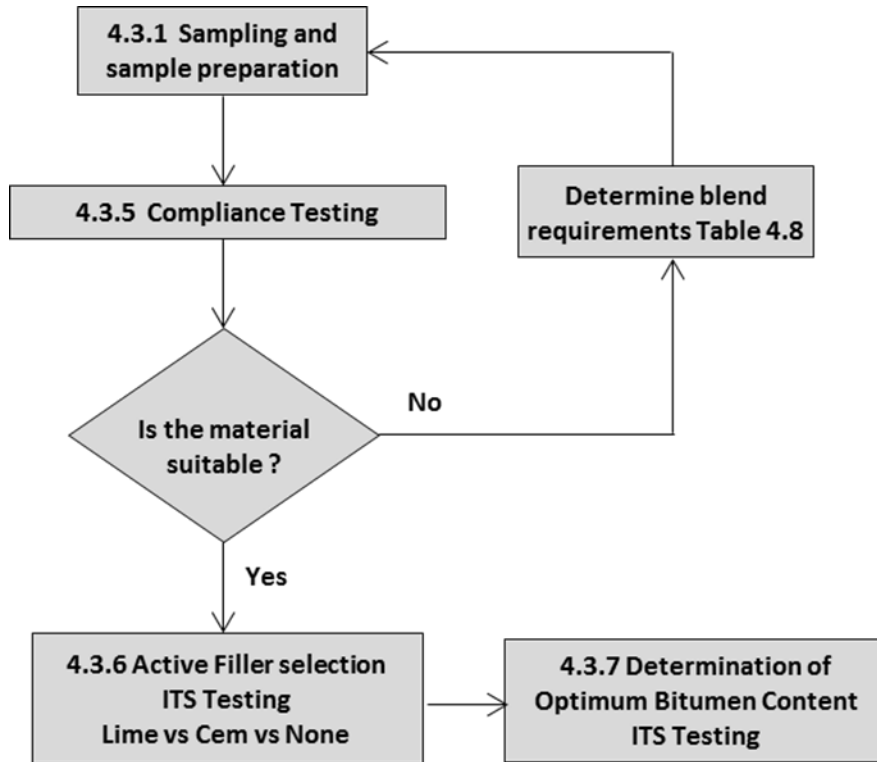

Figure 4.7 Optimisation of Bitumen Content

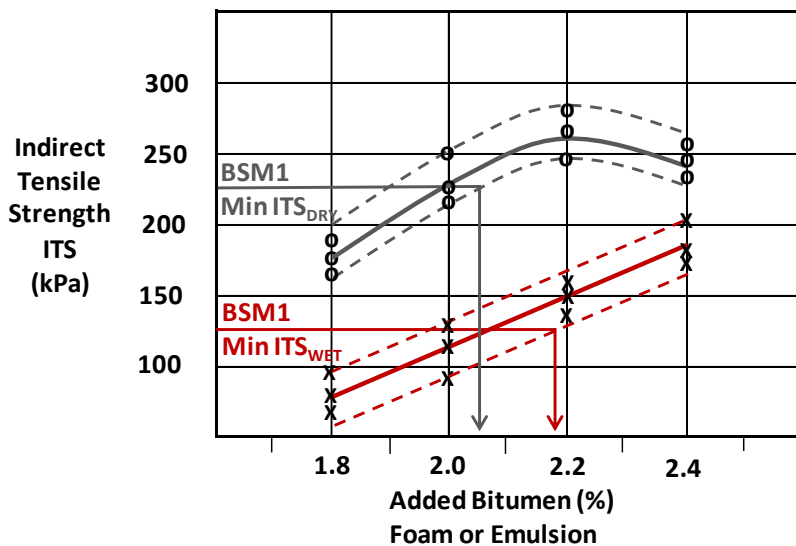

Figure 4.8 Selection of Bitumen Content from ITS_{DRY} and ITS_{WET}

4.3.8 Determination of the Shear Properties

The shear parameters, cohesion and internal friction angle, of the BSM provide critical performance properties and need to be evaluated for a reliable mix design. Five 30 kg samples are mixed, all at the optimum bitumen application rate and with 1% of the preferred active filler. These are then combined in a large container, thoroughly mixed together and sealed to retain moisture.

Sensitivity Tests

i Additional ITS tests using the procedure described above should be considered for materials that respond effectively to lower application rates of active filler.

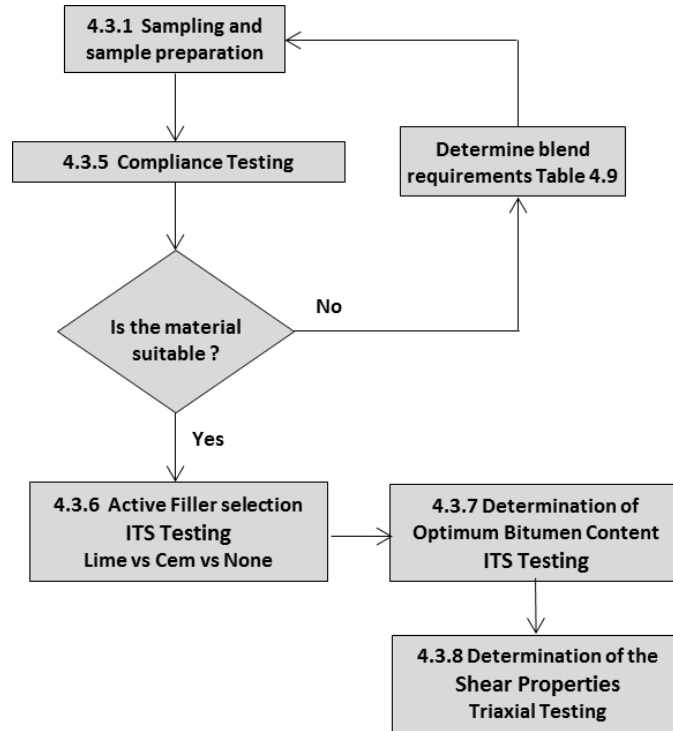

Figure 4.9 Triaxial Testing to Complete overall BSM Mix Design Procedure

Ten large triaxial specimens are manufactured in 5 layers of equal height in split moulds, using vibrating hammer compaction, see Appendix B. To ensure continuity across the joint between layers, the surface of the lower compacted layer is roughened using an inter-layer roughening device. Once complete, the specimens are cured following the procedure described in Section 4.3.1.8. Two specimens are soaked and eight left unsoaked.

The eight unsoaked specimens are then removed from their bags and subjected to triaxial testing, two specimens at each of four confining pressures: $\sigma_3 = 0$ kPa, 50 kPa, 100 kPa and 200 kPa. The maximum applied stress is determined for each confining pressure and used to plot the Mohr-Coulomb circles from which the shear properties of Cohesion (C) and the Internal Angle of Friction (ϕ) are determined, as shown in Figure 4.10.

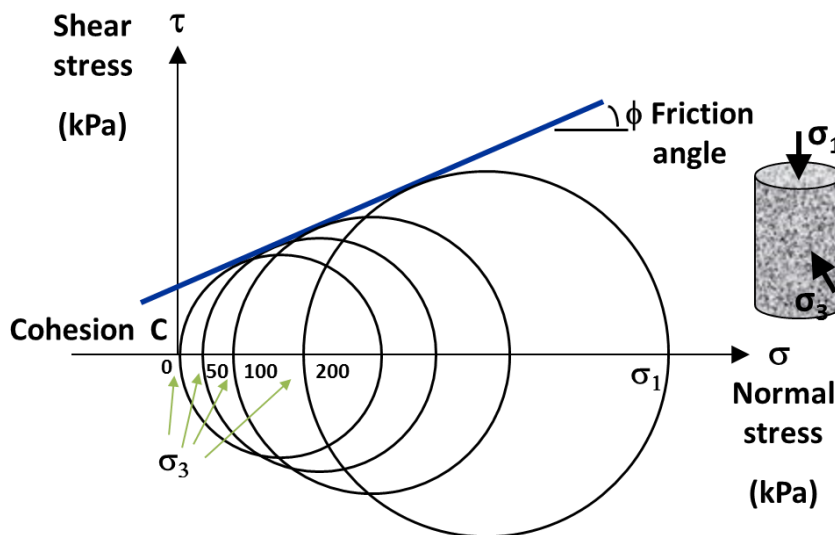

Figure 4.10 Mohr-Coulomb Plot of Monotonic Triaxial Results

The two soaked (or wet) specimens are then tested at a confining pressure of 100 kPa. The resulting applied stress ($\sigma_{1,f,s}$) compared with that for the unsoaked specimen (at equilibrium moisture content) at the same confining pressure $\sigma_{1,f,u/s}$ to determine the Retained Cohesion (RetC) as shown in Figure 4.8. This process is used to determine the moisture resistance of the BSM.

The Retained Cohesion is defined by the percentage of residual cohesion of the BSM after moisture exposure, as defined by the equation below:

$$\text{Retained Cohesion (RetC)} = \frac{\text{Cohesion}_{WET}}{\text{Cohesion}_{EQUIL}} = \frac{\sigma_{1,f,100,WET} - 100}{\sigma_{1,f,100,EQUIL} - 100} \cdot 100$$

Where:

$\sigma_{1,100,WET}$ = $\sigma_{1,f}$ for soaked specimen, submerged under water for 24 hour @ 25 °C and tested with $\sigma_3 = 100$ kPa confinement (kPa)

$\sigma_{1,100,EQUIL}$ = $\sigma_{1,f}$ for unsoaked specimen and tested with $\sigma_3 = 100$ kPa confinement (kPa)

Details pertaining to the test procedures for the determination of shear parameters as well as retained cohesion are included in Appendix B.

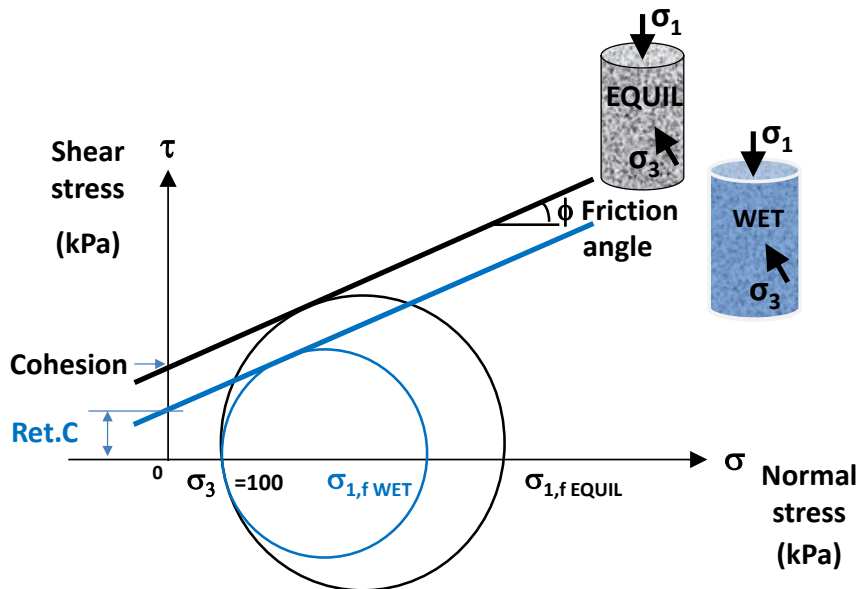

Figure 4.11 Evaluation of Retained Cohesion from Triaxial Tests

4.3.9 BSM Classification

In summary, the specification requirements are provided in Table 4.14.

Table 4.14 BSM Classification Limits

Class	RA (%)	ITS (kPa) ¹		Triaxial		
		ITS _{DRY}	ITS _{WET}	Cohesion (kPa)	Friction Angle (°)	Retained Cohesion (%)
BSM 1	< 50%	225	125	250	40	75
	50 – 100%	225	125	265	38	75
BSM 2	< 50%	175	100	200 ²	38	65
	50 – 100%	175	100	225	35	75

Note:

- 152 mm diameter specimen geometry used for ITS tests and 150 mm diameter for Triaxial tests
- The red Cohesion value of 200 kPa for BSM 2 with < 50% RAP was erroneously first published as 265 kPa. 200 kPa is correct.

CHAPTER 5: STRUCTURAL DESIGN

The purpose of the structural pavement design chapter is to identify layer materials that can provide a balanced pavement system with a reliable structural capacity to meet the traffic demand over the design period. In essence, pavement balance requires that there should be a gradual decrease in strength and stiffness from the top to the bottom pavement layers. The exception to this is the use of inverted pavement structures in South Africa. The structural design of pavements with BSM layers should follow these general principles and cognisance should be paid to general pavement design and rehabilitation guidelines, such as TRH4 (1996), TRH12 (1997) and SAPEM (2014).

This chapter presents the structural design methods recommended for BSMs. Two methods are recommended, the Pavement Number (PN) and Mechanistic-Empirical (ME) methods. The PN is discussed in Section 5.1 and the ME method in Section 5.2. This chapter also discusses Appropriate Surfacing (Section 5.3) and Economic Analyses and Maintenance Requirements (Section 5.4).

The structural design of BSMs does not differentiate between BSM-emulsion and BSM-foam.

BSM-emulsion **BSM-foam**

i The structural design of BSMs does not differentiate between BSM-emulsion and BSM-foam.

5.1 PAVEMENT NUMBER STRUCTURAL DESIGN METHOD

One method for the structural design of pavements incorporating BSMs is a knowledge based approach, termed the Pavement Number (PN).

The PN was first developed and published in the 2009 TG2 (2nd Edition). The method was initially based on the Structural Number concept, as used in the original AASHTO method. Some of the shortcomings of the Structural Number were overcome in the PN method. The 2009 version of the PN method was well received and is now widely used in South Africa. In the version of the PN method included in this manual, some of the shortcomings of the 2009 version have been addressed, and the method recalibrated with a larger database. The complete details of the revised method are included in Appendix C.

PN Method

i Complete details of the PN method are given in **Appendix C**.

Advantages of the PN method include:

- Data from in-service pavements were used to develop and calibrate the method, both for the 2009 version and the revision detailed in this guideline. The type and detail of the data suggest the use of a relatively simple method and precludes the use of a Mechanistic-Empirical design method.
- The method gives a good fit to the available field data.
- The method is robust and cannot easily be manipulated to produce inappropriate designs.

The PN method is applicable to all pavement materials commonly used in southern Africa. The method is applicable to Category A and B roads where the design traffic is less than 40 million equivalent standard axles (MESA). The method is designed to be used in conjunction with the DEMAC material classification system described in Chapter 3 and Appendix A.

This method relies on basic rules-of-thumb, which reflect well-established principles of pavement behaviour and performance, and which ensure an appropriate pavement design solution in most situations. The concepts in the rules-of-thumb are quantified into specific rules with constants or functions associated with each rule. The rules-of-thumb are briefly described in the following sections.

5.1.1 Applicability of Pavement Number Method

Before the Pavement Number method is used, the designer must check that the following situations do not apply:

- **Design traffic greater than 40 MESA.** The method was calibrated using a knowledge base which was limited to pavements that had accommodated less than 40 MESA. Thus, in such a design situation, the design should be checked using more in-depth analysis.
- **Presence of thin, weak lenses.** If thin, weak lenses of material exist below the surfacing, or between stabilised layers, then zones of high slip and shear will develop, and the PN calculations will not apply. In such instances, the structural capacity assessment of the PN method is not appropriate, and special treatment of the affected weak lens must be undertaken. The PN design method cannot be applied to situations where such lenses still exist within the pavement structure, especially where such lenses are located within the upper 400 mm. This limitation applies to most standard pavement design methods.
- **Subgrade CBR less than 3%.** The knowledge base on which the PN method was calibrated did not include any pavements that had a subgrade CBR less than 3%. The PN method should therefore not be used in cases where the subgrade CBR is less than 3% at a depth of 600 mm below the surface.
- **Thickness limits.** The PN has been calibrated for thicknesses within certain limits. Details are given in Appendix C.

This section presents a discussion of the basic rules-of-thumb underlying the method for calculating the PN. These rules reflect well-established principles of pavement behaviour and performance. The following rules-of-thumb, with particular reference to BSMs were adopted:

- Rules Relating to the **Pavement System in General:**
 - The structural capacity of a pavement is a function of the combined **long term load spreading** potential of the pavement layers and the **relative quality of the subgrade** on which the pavement is constructed.
 - The **relative quality and stiffness of the subgrade** is the departure point for design, as the subgrade is a key determinant in the overall pavement deflection, and in the relative degree of bending and shear that take place in overlying pavement layers.
 - For pavements with thin surfacings, the **base layer is the most critical component**, and failure in this layer effectively constitutes pavement failure. The relative confidence in different material types to serve as base layers under heavy traffic were determined by experience.
- Rules Relating to Specific Pavement Layers:
 - The **load spreading potential** of an individual layer is a product of its thickness and its effective long term stiffness under loading.
 - The **Effective Long Term Stiffness (ELTS)** of a layer depends on the material type and class, and on its placement in the pavement system.
 - Fine-grained subgrade materials act in a **stress-softening manner**. For these materials, the ELTS is determined mainly by the material quality and by the climatic region. Owing to the stress softening behaviour, subgrade materials generally soften with decreased cover thickness, which is taken into account.
 - Coarse-grained, unbound layers act in a **stress-stiffening manner**. For these materials, the ELTS is determined mainly by the material quality and the relative stiffness of the supporting layer. The ELTS of these materials increases with increasing support stiffness, and is governed by the **Modular Ratio**, up to a maximum stiffness which is determined mainly by the material quality.
 - BSMs are assumed to act in a similar way to coarse granular materials but with a higher cohesive strength. The cohesive strength is subject to breakdown during loading through energy dissipation and thus some softening over time can occur. The rate of softening is mainly determined by the stiffness of the support, which determines the degree of shear in the layer. However, owing to the higher cohesive strength in bituminous stabilised materials, these layers are less sensitive to the support stiffness than unbound granular materials and can therefore **sustain higher Modular Ratio limits**.
 - If the cement content of a BSM mix exceeds 1%, then the material is assumed to behave as a cemented material.

i **Thin Surfacing**
 For pavements with thin surfacings, the **base layer is the most critical component** and failure in this layer effectively constitutes pavement failure.

The above-noted rules-of-thumb introduce several concepts such as the ELTS, Modular Ratio limit and stress-stiffening behaviour. These terms are briefly described in the following section.

5.1.1.1 The Effective Long Term Stiffness (ELTS)

The ELTS is a model parameter which serves as a relative indicator of the average long term in situ stiffness of a pavement layer. As such, the ELTS averages out the effects of changing stiffness owing to traffic related deterioration, seasonal variations in stiffness, and changes in materials. Thus, the ELTS does not represent the stiffness of a material at any specific time.

The ELTS is also not a stiffness value that can be determined by means of a laboratory or field test. It is a model parameter, which is calibrated for use in the PN design method. It may, therefore, differ from stiffness values typically associated with material classes.

i **ELTS**
This is a relative indicator of the **average long term in situ stiffness**, and does not represent the stiffness at any specific time.

5.1.1.2 Modelling of Subgrade Materials

Characterization of the support is critical to the pavement design of all pavements, including pavements with BSM layers. For new construction, the TRH4 procedure for delineation of the in situ subgrade and for importing selected subgrade material applies. The TRH4 guideline is especially relevant when the structural strength of the in situ subgrade is insufficient, i.e., CBR < 3% or problem soils are present. For rehabilitation projects, the guidelines in TRH12 and SAPEM for evaluating and designing for changing support conditions should be followed in conjunction with the PN method.

i **Subgrade ELTS**
Depends on:
Material class
Climate
Depth of cover

The first step in the calculation of the PN-value is the determination of the subgrade material class. To do this, specific guidelines are provided in Appendix C.

Once the subgrade class has been determined, the ELTS for the subgrade is calculated. This involves the following steps:

1. Assignment of a basic long term stiffness based on the materials class.
2. Adjustment of the basic long term stiffness for different climatic regions: wet, dry or moderate.
3. Adjustment of the stiffness to account for the depth of subgrade cover.

The adjustment of the subgrade stiffness to take account of the depth of cover accounts for the stress-softening tendencies of fine grained materials under load. The details on the relationship between the cover depth and the adjustment to the subgrade stiffness are given in Appendix C.

5.1.1.3 The Modular Ratio Limit and Maximum Allowed Stiffness

The Modular Ratio is defined as the ratio of a layer's stiffness relative to the stiffness of the layer below it. Thus, if the stiffness of a base layer is 300 MPa, and the stiffness of the support below it is 200 MPa, then the Modular Ratio of the base layer is 1.5.

i **Modular Ratio**
This is ratio of a **layer's stiffness** relative to the stiffness of the layer below.

The Modular Ratio accounts for the stress-sensitive stiffness of granular and, albeit to a lesser extent, BSM materials. The stress-sensitivity causes the stiffness of the material to decrease when the material is placed over a weaker, less stiff support. This decrease in stiffness occurs where the support layer is soft, causing a tendency for the overlying layers to bend into the support, thereby increasing the likelihood of developing higher shear and tensile forces in the overlying layers. This effect limits the stiffness that can be obtained in a stress-sensitive layer placed over a weaker support. By placing a limit on the Modular Ratio that can be sustained for a specific material, it is ensured that the stiffness value assumed for that layer is realistic, given the material quality and stiffness of the support. In essence, the concept of a limiting Modular Ratio for materials ensures that stress-sensitive stiffness behaviour is implicitly taken into account.

The Modular Ratio that a material can sustain varies over the life of a pavement. In the PN method, it pertains to the overall long term stiffness that a material can maintain.

5.1.1.4 Maximum Allowed Stiffness

Under the action of loading, there is a maximum stiffness that materials can achieve, which depends on the quality of the material. Less dense and angular materials will not develop very high stiffnesses under loading, regardless of the stiffness of the support.

In the PN model, the Modular Ratio limit and the maximum allowed stiffness are used extensively to determine realistic ELTS values. These parameters are used in the following way:

1. The **stiffness of the supporting layer** is first determined. Thus, the PN calculation process starts from the subgrade and proceeds upward toward the surfacing.
2. The **Modular Ratio limit** and **maximum allowed stiffness** for each layer are given based on the material type and class.
3. The **ELTS** for a layer is calculated as the support stiffness multiplied by the Modular Ratio limit, and checked against the maximum allowed stiffness. In other words, the minimum of the maximum allowed stiffness and the product of the support stiffness and Modular Ratio.

The ELTS values for BSMs are higher than that of granular materials because they can sustain a higher stiffness. In the case of base layers, the ELTS is further adjusted by means of a base confidence factor. The ELTS of stabilised layers are also adjusted for thickness by the thickness adjustment factors.

5.1.1.5 The Base Confidence Factor

The type of material in the base layer is an important determinant of the performance of the pavement because the base is the main load bearing element in the pavement system and failure of the base effectively constitutes pavement failure. Experience has shown that there is a limit on the types of base materials that can be considered for any given traffic situation. In particular, suitable design options are significantly limited as the design traffic increases.

In the PN method, the appropriateness of the base material is controlled by the Base Confidence Factor (BCF) which is used to adjust the ELTS for the layer.

5.1.1.6 Thickness Adjustment Factors

Thickness adjustment factors are used for all stabilised layers, including asphalt surfacings and bases, cement stabilised and BSM layers. This is to adjust the PN appropriately as the layer thicknesses increase. The details of the adjustment factors for the stabilised materials are given in Appendix C.

The values used for the ELTS, Modular Ratio, layer thickness limits and BCF are specific to the PN method and should not be adjusted by the designer. The relevant values for BSMs are shown in Table 5.1.



BCF

To prevent the use of inappropriate bases, a Base Confidence Factor is assigned, which depends on the type of materials.

Table 5.1 PN Method Input Values for BSMs

Material Class	BSM1	BSM2
General Material Description	High strength bitumen stabilised material, normally using crushed stone or reclaimed asphalt (RA) source material	Medium strength bitumen stabilised material, normally using natural gravel or RA source material
Modular Ratio Limit	3.0	2.5
Maximum Allowed Stiffness (MPa)	700	600
Base Confidence Factor	1.0	0.7
Thickness limit	100 mm to 300 mm	

5.1.2 Pavement Number Calculation

Appendix C contains the full details of the PN calculation along with a worked example. The main steps are summarized below. In a pavement design situation, the steps described are applied for each uniform design section. For rehabilitation design situations, it is presumed that the designer will have detailed information on the existing pavement layer properties for each uniform section.

- Step 1.** Check to ensure that the design method is applicable for the design situation.
- Step 2.** Determine the layer thicknesses, and available material properties for each layer. Determine the design equivalent material class (DEMAC) using the guidelines in Appendix A. To prevent the use of unrealistic layer thicknesses, and to limit the pavement thicknesses to those for which the method has been calibrated, maximum and minimum limits are given. BSM layers can only have a thickness between 100 mm and 300 mm.
- Step 3.** Combine layers with similar properties to obtain a five layer pavement system, including the subgrade (four layers plus the subgrade). Appendix C gives specific guidelines for combining layers. Check that the layer thicknesses are within the limits for design purposes.
- Step 4.** Determine the basic stiffness of the subgrade by means of the given values (Appendix C). Adjust the stiffness for the climatic region and depth of subgrade cover.
- Step 5.** For each layer above the subgrade, determine the Modular Ratio limit and maximum allowed stiffness.
- Step 6.** Use the Modular Ratio limit and maximum allowed stiffness to determine the ELTS for each layer by working up from the subgrade.
- Step 7.** For the base layer, determine the Base Confidence Factor (BCF).
- Step 8.** For asphalt, cement stabilised and BSM layers, determine the thickness adjustment factors.
- Step 9.** For each layer, calculate the layer contribution using the ELTS and layer thickness, and BCF and thickness adjustment factors where applicable.
- Step 10.** Add the layer contributions for each layer to get the PN.
- Step 11.** Determine the minimum expected structural capacity in standard axles of the pavement for the applicable Road Category (A and B) from the frontier curve (Appendix C).

5.2 MECHANISTIC-EMPIRICAL DESIGN

The South African Mechanistic-Empirical Design Method has been widely used in South Africa for many years. Conventional materials pavement design such as asphalt, graded crushed stone, gravel, cemented materials and soil and their engineering properties for mechanistic-empirical (ME) design are catered for in SAPEM (2014). BSM is not, however, included, therefore a new structural design function has been developed for these purposes.

The three primary pavement input variables for each layer in a pavement's mechanistic design include Resilient Modulus, Poisson's Ratio and layer thickness. The first variable, Resilient Modulus, can be selected based on each material's classification according to standard tests. The DEMAC system described in Chapter 3 and Appendix A is very useful for classifying materials. Guidelines for how to determine the appropriate properties are listed in Steps 1 and 2.

Step 1. Material Classification from Investigation and Testing

- Granular: Shear properties, SAPEM Chapter 10, Table 31
- Cemented: Strength and flexibility, SAPEM Chapter 10, Table 34

Alternatively, guidelines are given in SAPEM, Chapter 10, for the investigation and testing of pavement layers. The DEMAC method in Appendix A is also useful for classifying materials.

Step 2. Guideline for Initial Allocation of Resilient Modulus Values

SAPEM contains guidelines for the selection of appropriate resilient modulus values for asphalt, granular, cemented and subgrade materials. Recommended Modular Ratios for granular materials are given in Table 5.2. A range of recommended resilient moduli for BSMs are given in Table 5.2, with a recommended value shown in parenthesis.

- Asphalt: SAPEM Chapter 10, Table 27
- BSMs: See Table 5.2
- Granular: SAPEM Chapter 10, Table 29
- Cemented: SAPEM Chapter 10, Table 34
- Subgrade: SAPEM Chapter 10, Table 36

Table 5.2 Recommended Resilient Moduli and Modular Ratios for BSMs

BSM Class	Modular Ratio ²	Long Term Resilient Moduli (MPa)	
		Cemented Supporting Layer	Granular or BSM Supporting Layer
BSM1	3	700 to 1200 (800)	600 to 1000 (700)
BSM2	2.5	550 to 800 (600)	450 to 750 (500)
Asphalt	4	See Guidelines in SAPEM, Chapter 10	
C3 ¹	4		
C4 ¹	3		
G1	2		
G2	2		
G3	1.9		
G4 / EG4	1.9		
G5 / EG5	1.8		
G6 / EG6	1.8		
G7	1.7		
G8	1.6		
G9	1.4		
G10	1.2		

Notes:

1. A cemented subbase must still have active cement and a resilient modulus indicative of stabilisation to use the rehabilitation design values in the table. If not, the equivalent granular option should be selected.
2. The Modular Ratios recommended for ME Design may differ from those recommended for the Pavement Number Method.

Step 3. Balancing the Pavement

The selection of layer moduli for ME analysis should take cognisance of the Modular Ratio (MR) which is the relative stiffness between two adjacent layers. The following steps are undertaken:

- Allocate a resilient modulus for the subgrade based on the material classification, climate and moisture conditions.
- Allocate a resilient modulus for the layer above the subgrade based on the material classification, Modular Ratio, and SAPEM Guidelines.
- Working up through the pavement, allocate the resilient modulus for the layers below the BSM base, following the same guidelines. For rehabilitation designs, existing cemented subbase layers should be allocated resilient modulus values based on the Equivalent Granular classification of the layer from investigation results.
- Recommended Modular Ratios for pavement layers evaluated using ME Design are outlined in Table 5.2.

Step 4. Sub-layering

BSM materials response to loading is similar to that of granular materials, i.e., both materials are stress dependent. For this reason, it is possible to sub-layer BSM layers thicker than 200 mm, using resilient moduli that adhere to the Modular Ratio guidelines. This can provide a more realistic stiffness gradient for pavement structures with thick layers. This practice should be restricted to experienced pavement designers.

Sub-layers should be of equal thicknesses, regardless of how the pavement is actually constructed. In addition, individual sub-layers must exceed 100 mm in thickness to avoid unrealistic outcomes from Modular Ratios and layer analyses. Layers that exceed 250 mm should be analysed as both a single layer and two equal sub-layers.

For sub-layers, initially allocate the resilient modulus for each sub-layer using the Modular Ratio rule and considering the maximum resilient modulus or using evidence from the rehabilitation analyses and associated pavement and material tests.

Step 5. Analysis Positions

The BSM analysis position is at the top quarter position of the layer, i.e., at a depth of one-quarter of the thickness from the top of the layer.

The granular, cemented and asphalt layer analysis positions should follow the standard positions detailed in SAPEM (2014).

Step 6. Inputs to the Stellenbosch BSM Design Function

The manner in which the three variables that form part of the BSM structural design function are implemented, is discussed in this section. The three inputs are:

- Deviator stress ratio
- Compaction density
- Retained cohesion

i. Deviator Stress Ratio

The Deviator Stress Ratio is defined as the ratio of the actual (applied) deviator stress to the maximum (failure) deviator stress, and expressed as a percentage. The Deviator Stress Ratio is a critical performance parameter in defining the rate of permanent deformation of a granular or BSM material. It is calculated using these equations:

$$\text{Deviator Stress Ratio (DSR)} = \frac{\sigma_d}{\sigma_{d,f}} = \frac{\sigma_1 - \sigma_3}{\sigma_{1,f} - \sigma_3}$$

$$\sigma_{1,f} = \frac{(1 + \sin\emptyset) \cdot \sigma_3 + 2 \cdot C \cdot \cos\emptyset}{(1 - \sin\emptyset)}$$

where

<i>DSR</i>	=	<i>Deviator Stress Ratio expressed as a fraction</i>
σ_1	=	<i>Major principle stress in the layer (kPa)</i>
σ_3	=	<i>Minor principle stress in the layer (kPa)</i>
$\sigma_{1,f}$	=	<i>Major principle stress at failure from a triaxial test (kPa)</i>
<i>C</i>	=	<i>Cohesion value of BSM from project mix design (kPa)</i>
\emptyset	=	<i>Friction Angle of BSM from project mix design</i>

For preliminary structural designs, where the full mix design has not yet been carried out, the shear parameters can be estimated from the ITS values. For example, if the ITS values comply with BSM classification, e.g., BSM1 with $ITS_{\text{DRY}} > 225$ kPa and $ITS_{\text{WET}} > 125$ kPa, then default input values of Cohesion (*C*) and Friction Angle (\emptyset) can be used for deviator stress ratio input based on Table 5.3. The actual test results must be verified later.

Table 5.3 Default Values for the BSM Shear Parameters in Preliminary ME Design

Material Class	Percent of Reclaimed Asphalt	ITS (kPa)		Triaxial		
		ITS _{DRY}	ITS _{WET}	Cohesion (kPa)	Friction Angle (°)	Retained Cohesion (%)
BSM 1	< 50%	225	125	250 – 300 (250)	40 – 50 (40)	70-85 (75)
	50 – 100%	225	125	265 – 350 (265)	38 – 45 (38)	75-90 (75)
BSM 2	< 50%	175	100	200 – 250 (225)	38 – 40 (39)	65-75 (70)
	50 – 100%	175	100	225 – 250 (238)	35 – 40 (37)	70-85 (75)

Note: Ranges of input values are provided, with recommended default values in parentheses.

Mechanistic software analysis is used to establish the major and minor principal stresses in the BSM layer at a depth of a quarter of the layer thickness. Using the Cohesion and Friction Angle from a triaxial test or default values, the deviator stress ratio (DSR) is calculated using the equation above. The Stellenbosch BSM transfer function has been developed to relate the DSR to 10 mm of rutting in the layer.

ii. Compaction Density

The compaction density input variable, termed P_{MDD}, refers to the specified density of the BSM as a percentage of the Maximum Dry Density (MDD), previously known as the Modified AASHTO density. Some guidance to the selection of density is as follows:

- BSM 1 is typically compacted to at least 100% of MDD.
- BSM 2 is typically compacted to at least 98% of MDD.

Only in exceptional cases is a lower density specified. Conversely, if a higher density than the specified density is achieved, this contributes to improved performance but is not provided for in the analysis.

iii. Retained Cohesion

Retained Cohesion is evaluated as the ratio of the soaked and unsoaked major principal stress at failure from triaxial testing at a confinement value of σ₃ = 100 kPa. The “soaked” condition relates to submersion of the compacted and cured triaxial specimen under water for 24 hours and 25 °C before testing. The “unsoaked” condition refers to a standard compacted and cured triaxial specimen being conditioned to 25 °C in a climate chamber for at least 4 hours. The calculation is based on the average of 2 soaked specimens and 2 unsoaked specimens.

$$Retained\ Cohesion\ (RetC) = \frac{Cohesion_{WET}}{Cohesion_{EQUIL}} = \frac{\sigma_{1,f,100,WET} - 100}{\sigma_{1,f,100,EQUIL} - 100} \cdot 100$$

Where:

- σ_{1,100,WET} = σ_{1,f} for soaked specimen, submerged under water for 24 hour @ 25 °C and tested with σ₃ = 100 kPa confinement (kPa)
- σ_{1,100,EQUIL} = σ_{1,f} for unsoaked specimen and tested with σ₃ = 100 kPa confinement (kPa)

For preliminary structural designs, where the full mix design has not yet been completed and the original material being stabilised with bitumen classifies as G4 or better and the ITS values exceed those given in Table 5.3, then a default value of RetC = 75% can be used for the Retained Cohesion input. The actual test results must be verified later.

Step 7. Using the Stellenbosch BSM Design Function

The new Stellenbosch BSM Design Function has been developed based on the latest laboratory and field performance correlations, as presented at CAPSA (2019):

Stellenbosch BSM Function

$$\log N = A - 57.286(DSR)^3 + 0.0009159(P_{MDD} \cdot RetC)$$

where:

N = Number of axle repetitions to reach a set rut depth

A = Reliability Coefficient linked to Road Category

<u>Reliability</u>	<u>Road Category</u>	<u>A</u>	<u>Rut Limit (mm)</u>
95%	A	1.71113	10
90%	B	1.79873	15
80%	C	1.88733	20
50%	D	2.00443	25

DSR = Deviator Stress Ratio, as a fraction

P_{MDD} = BSM dry density expressed as a percentage of MDD (%)

RetC = Retained Cohesion (%)

As is the case with typical Mechanistic Empirical Design approaches, each layer and individual material requires separate assessment to determine its life. The life of the overall pavement structure is determined by the layer with the shortest life, termed the critical layer.

A worked example of a structural design for a pavement with a BSM base is included in Appendix C. The PN Design method as well as the Mechanistic Empirical Design method are compared.

5.3 APPROPRIATE SURFACINGS

The selection of a surfacing type to overlay a BSM base should be based on sound structural design and economic considerations as well as the functional requirements of the road. Based on observations from in-service pavements, roads carrying in excess of 1 MESA but less than 3 MESA either have an asphalt surfacing or a seal. Based on these observations, recommendations for the minimum surfacing thickness are shown in Figure 5.1. For traffic less than 3 MESA, a surfacing seal should be adequate. For traffic between 3 and 15 MESA, the formula shown in Figure 5.1 should be used, with the thickness rounded to the nearest 5 mm. For traffic exceeding 20 MESA, an asphalt thickness of at least 50 mm is recommended.

5.4 ECONOMIC ANALYSES AND MAINTENANCE REQUIREMENTS

The purpose of structural pavement design is to identify pavements with the same structural capacity that meet the traffic demand. The present worth of the construction and life-cycle cost of the alternative designs are then compared to select the most cost effective design. The alternatives should be compared in terms of total project cost. The reader is referred to TRH4 (Table 24) and to Table 5.4 below for an indication of the estimated typical future maintenance requirements for life cycle cost analysis. The estimates in Table 5.4 assume a 20 year structural design life.

The discount present worth of cost approach described in TRH4 is recommended for the project level analysis of pavements containing BSM layers. The cost comparison should not attempt to justify the economic benefits of a labour-intensively constructed pavement by comparison with that of a machine-constructed pavement. The decision to use labour-intensive construction should be taken at a policy level, not at the project level.

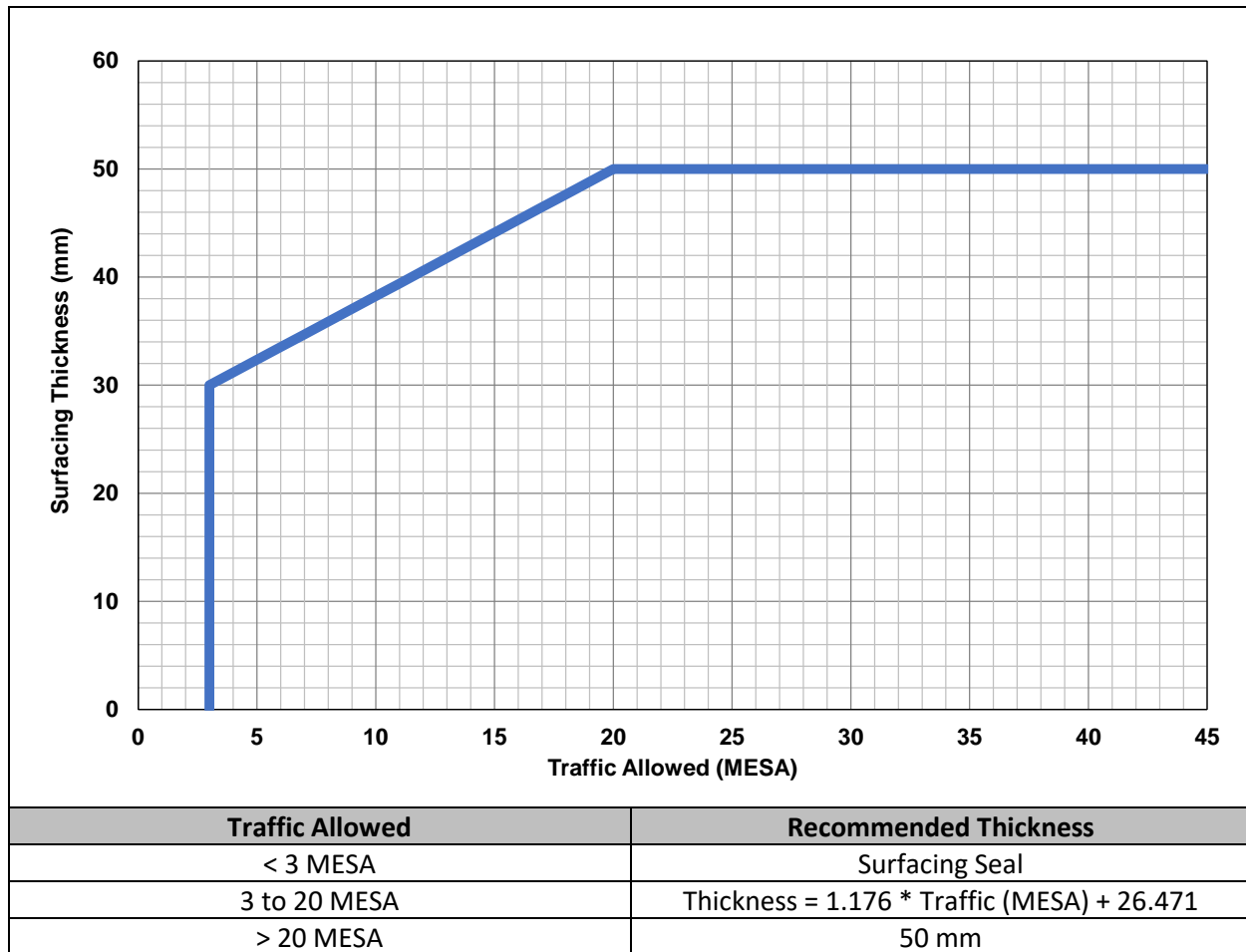

Figure 5.1 Minimum Surfacing Thickness for BSM Pavements

Table 5.4 Typical Future Maintenance Measures for BSM Base Pavements

Measures to Improve the Surfacing Condition		Structural Maintenance	
Original surfacing		Moderate distress	Severe distress
Surface treatment	Asphalt		
S1 (9 years) ¹ S1 (14 years) S1 (19 years)	S1 (12 years) S1 (17 years) ²	30 to 40 mm A ³	> 100 mm BTB ⁴ BSM Overlay ⁵

Notes:

1. S1 (9 years) represents a single surface treatment after nine years.
2. For low trafficked roads this seal may be replaced with a 50 mm overlay to increase the structural capacity.
3. A is an asphalt surfacing.
4. BTB is bitumen treated base.
5. BSM overlay should be plant mixed.

CHAPTER 6. CONSTRUCTION

This chapter provides guidelines for constructing pavement layers using BSMs. An explanation of the general construction approach to BSMs is provided. This is followed by specific construction requirements for working with BSMs when either bitumen emulsion or foamed bitumen is applied as the stabilising agent. Aspects specific to either BSM-emulsion or BSM-foam are clearly highlighted.

From a construction perspective, once bitumen emulsion or foamed bitumen has been mixed into a material, the resulting BSM behaves in a similar way to an untreated granular material. The various construction operations required to place the material, cut levels, compact to achieve the required density and finish off the new layer are practically the same as those for an untreated material. The behavioural characteristics that influence the workability of the material before it is finally compacted and finished off are similar to that of untreated materials. It is the performance properties of the layer of treated material that are different from those of the untreated material.

Contrary to some misconceptions, treating a granular material with foamed bitumen does not create a cold-mix asphalt, regardless of the application rate. Similarly, treating a granular material with a relatively small amount of bitumen emulsion ($\pm 2.0\%$ residual bitumen by mass) does also not create a cold-mix asphalt. The treated material remains granular in nature and must be processed in the same way as untreated material for layer construction.

Early trafficking is one of the primary benefits of treating with foamed bitumen. The instant increase in cohesion when the treated material is compacted allows the new layer to be trafficked immediately after construction. When treating with bitumen emulsion, the increase in cohesion is a relatively slow process, dictated by the rate at which the bitumen breaks out of suspension.

Early Trafficking

i Early trafficking is one of the primary benefits of treating with foamed bitumen.

The type of project that is undertaken is the primary factor influencing the approach to construction. Figure 6.1 illustrates the options available for BSMs.

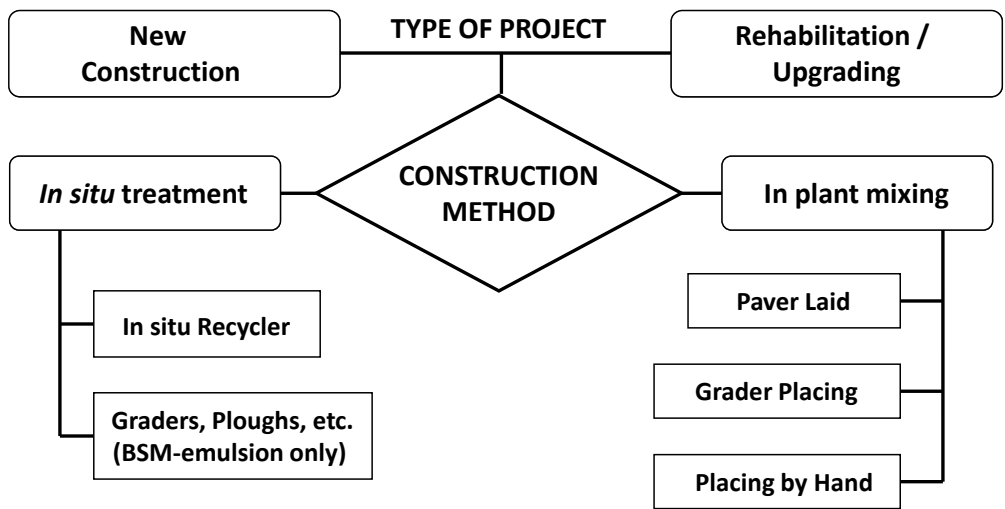

Figure 6.1 BSM Construction Options

The type of project and the specific requirements for constructing a new layer using BSM falls under one of two primary categories: new construction or pavement rehabilitation/upgrading. The method selected for treating the material with bitumen (in situ or in plant) determines the options available for processing the material to construct the new layer.

In situ treatment requires a different construction approach to material that is treated in plant and these are explained in two separate sections. In situ treatment is covered in Sections 6.1 to 6.3 and in plant treatment in Section 6.4. Each of these sections describes the complete construction procedure, including material preparation, mixing, placing, achieving the required final surface levels, compaction and finishing off. This is followed by sections that are common to all BSM construction projects: curing requirements for the finished layer, trafficking, applying the surfacing and the construction of trial sections. Controls that are essential for ensuring the quality of the work produced are explained in detail in Appendix D.

6.1 IN SITU TREATMENT

Although purpose-built recycling machines have generally replaced conventional construction equipment, such as graders, ploughs, rotavators, etc., for in situ treatment, conventional equipment remains an option for BSM-emulsion on projects where the cost of establishing a large recycler may not be justified. Due to the short time available for mixing, foamed bitumen cannot be used with conventional construction equipment. Construction with recyclers is discussed in Section 6.2. This is followed by Section 6.3 that covers the use of conventional construction equipment to apply bitumen emulsion.



6.2 IN SITU TREATMENT USING RECYCLERS

This section describes the operations involved when a recycler is used to bitumen stabilise material recovered from the existing road. This is applicable to pavement rehabilitation as well as new construction where the material to be treated is first placed on the road before being treated in situ. In addition to the recycling operation that incorporates material recovery and mixing, this section explains the requirements for placing and compacting the treated material, as well as finishing off the new layer, all focused on the factors that are important when using a recycler to construct a new BSM layer.

6.2.1 Factors Influencing the Work

No two projects are the same. Where material is to be treated in situ, there are numerous factors that need careful consideration and planning before the work can begin. The daily production of a recycling train can be as much as 5000 m², or more. When foamed bitumen is applied, there is usually the demand to open the completed work to traffic at the end of the day's work. Meticulous planning and diligent execution is required to ensure that such output potential is realised without compromising quality. The factors that need to be considered when planning recycling projects are described in the following sections.

6.2.1.1 Project Specific Details

The following are primary factors influencing an in situ recycling job:

- **Project location.** A project in an urban environment demands a totally different approach to one in a remote undeveloped region. The availability of plant, skilled labour and materials, as well as access to the site are important factors.
- **Size of project.** Large highway rehabilitation projects that span lengthy periods of time require significantly more management input than a small one-week long job.
- **Type of project.** Where in situ recycling is the primary construction activity, for example, where the existing pavement is recycled to form a new base layer with only the surfacing to follow, a different approach is required from that where the in situ recycling work is a small component, confined to treating only a portion of the total work.
- **Complexity.** The planning required to recycle a two-lane road in a rural region is very different from the complexity of recycling a multi-lane highway in an urban environment.

- **Climate.** Temperature and rain are primary determinants for when and how bitumen stabilisation can be successfully carried out.

6.2.1.2 Material in the Recycling Horizon

Information obtained from investigations concerning the type and condition of the material to be recycled is vital since it dictates whether the material can simply be recycled in situ, the type of recycling machine required to do the work and/or if some preliminary work is needed before recycling can commence, e.g. pre-pulverising or importing new material. If such information is not available, it must be acquired. This is normally undertaken by opening small inspection holes at regular intervals and sampling the material from the recycling horizon.

Recycling machines pulverise the existing pavement layer(s) to the required depth, breaking down the upper portion of a layered pavement structure to produce material that is essentially granular in nature. The recycler's drum is designed to break down previously bound material, such as asphalt and cement treated bases. Due to the upward rotating direction of the drum, the reclaimed material is lifted and tends to "fall apart", rather than crushed into smaller particles. Very little aggregate crushing occurs and the underlying pavement remains in an undisturbed state. The degree of pulverisation that is achieved depends on the strength and condition of the in situ material. Lightly cemented material generally breaks down to resemble the grading of the aggregate that was used in the original construction.

The grading of reclaimed asphalt (RA) is more difficult to control since it is influenced by several variables. These include:

- Degree of age-hardening of the bitumen binder in the RA. For example, recently applied asphalt patches containing fresh binder will break down differently from the aged asphalt.
- Total thickness of asphalt. Thin layers tend to produce more "chunks" than thick layers.
- Original asphalt mix, particularly the quality and grading of the aggregate.
- Extent and geometry of crocodile cracks in the upper asphalt layers.
- Effectiveness of the bond between various asphalt overlays.
- Peripheral speed of the cutting tools on the drum, machine advance speed and the position of the "breaker bar" mounted at the front of the milling chamber.
- Temperature of the asphalt during the recycling process.

One of the main reasons for conducting a Trial Section (see Section 6.7) is to determine how the material in the existing pavement will break down when recycled. Such Trial Sections should, therefore, be carefully selected to be truly representative of the pavement to be recycled.

Where the existing asphalt cannot be broken down by the recycler to produce a reasonably uniform grading, for example, where the recycled material is dominated by large chunks of asphalt, the material will have to be pretreated prior to being recycled. Such pretreatment is described in the Section 6.2.1.3 iv. Alternatively, consideration should be given to changing the operation from in situ recycling to in plant treatment by milling off all the asphalt, passing it through an impact crusher (to break down the chunks) and then treating in plant.

6.2.1.3 Preliminary Work Requirements

Any work that needs to be carried out on the existing road prior to recycling must be carefully scheduled in order to avoid delays. Such preliminary work generally falls under one of the following headings:

i. Survey Control

Most pavement rehabilitation projects call for the existing road to be recycled in situ. This implies that existing surface levels and shape are retained, thereby eliminating the need for extensive survey and design input. The survey controls required are best carried out by staking the existing road and transferring relevant surface

elevations to a series of level-control poles placed at regular intervals outside both shoulder edges. This system is used on most construction projects.

In situ recycling is not an appropriate rehabilitation strategy where the geometrics of the existing road require significant changes, for example, adjusting the road alignment. Minor level corrections ($\pm 100\text{mm}$) can be accommodated provided they do not lower the recycling horizon to include a different type of material. Raising the final surface elevations can be accommodated by importing and spreading new material before recycling, provided the thickness of new material is less than the recycling depth.

ii. Removal of Obstacles

Manholes and other such obstructions are often encountered when recycling, especially in urban areas. Such obstacles cause a discontinuity in the recycling work and are, therefore, best dealt with by removing them before starting to recycle. Such removal normally involves excavating down to a depth of 200 mm below the recycling horizon, extracting the concrete manhole rings and/or any other service device, installing a thick metal plate and backfilling with material similar to that in the recycling horizon. The backfill material must be thoroughly compacted to prevent a shortfall when recycling.

Prior to their removal, the precise location of each manhole must be diligently recorded so that they can be re-established after the roadworks are complete. In addition, to prevent damaging the recycler's drum, a metal detector should be used to locate manhole covers and other such obstacles that may be buried beneath an asphalt overlay.

iii. Cleaning the Road Surface

To prevent contamination, all foreign matter (including standing water) must be removed from the road surface before starting to recycle. The source of any foreign matter should also be investigated and addressed, such as eroded material from an unsurfaced access road.

iv. Dealing with Layers of Severely Distressed Asphalt

Where asphalt in the recycling horizon is severely shattered with multiple crocodile cracks, it may not be broken down sufficiently when recycled in situ, producing a material that is dominated by large chunks of asphalt. Being heavier, such large particles (chunks) will be thrown to the bottom of the layer as a consequence of centrifugal forces generated by the rotating action of the drum. The finer material remains on the surface, masking the problem. Such a scenario is normally dealt with in one of two ways:

- Use a milling machine to pulverise the material, leaving the pulverised material on the road to be spread, shaped and compacted before recycling. Such a milling operation is different from normal milling where the asphalt is removed as fast as possible. Where the objective is to break down the asphalt, the milling machine must be set up with the breaker bar lowered to achieve maximum fragmentation and the speed of advance reduced to optimise such fragmentation. In addition, the depth of cut should be maintained $\pm 5\text{mm}$ above the bottom of the asphalt layer.
- Remove all the asphalt to temporary stockpile as a normal milling operation. The stockpiled material is then passed through an impact crusher with the gap set at $\pm 20\text{ mm}$. The objective is to break down the chunks of asphalt, not to crush the aggregate in the asphalt. The material can then be returned to the road and treated in the same way as other imported material (described in Section 6.2.2.1 iv).

v. Correcting Poor Surface Shape (cross-section profile)

As explained in Chapters 2 and 3, recyclers run on top of the existing road surface with the drum lowered into the pavement. The depth of cut is pre-set relative to the chassis of the recycler and is held constant while the machine advances. Where the cross-slope of the road changes, for example, on curves, the chassis and cutting depth follow the change in slope.

If the road is out of shape, such as lacking camber, the machine will follow the existing (incorrect) road shape, as will the cut horizon. This results in variations in the thickness of the recycled layer when final levels are cut to achieve the required camber. Where centre-line elevations are retained in order to accommodate traffic when constructing in half-widths, such practice compromises the structural adequacy of the rehabilitated pavement because treated material is bladed off the outer wheel path (see Figure 3.5). Similarly, if centre-line levels are raised to achieve the required camber, material is bladed up from the outer extremities, thereby reducing the layer thickness in the outer wheel paths.

It must also be appreciated that the application of water and bitumen stabilising agent is constant across the width of the respective spraybar with each nozzle effectively injecting the same quantity in terms of flow rate. As shown in Figure 6.2, undulations in the surface will cause the volume of recovered material to change, resulting in a variation in the application rate. Such variations can be significant when the depth of cut is small (≤ 150 mm).

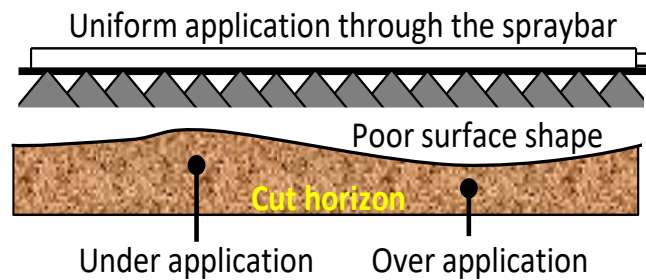

Figure 6.2 Consequence of Poor Surface Shape

Roads that are badly out of shape should, therefore, be corrected before starting to recycle. Pre-shaping essentially establishes the required final surface shape, both in cross-section and long-section before recycling. This allows the required thickness to be achieved across the full cut width together with a uniform application of water and stabilising agents applied through the spraybars.

There are three options for obtaining the required shape on an existing road:

- Use a milling machine to achieve the required surface shape by removing material.
- Use a recycler to pre-pulverise the material in the recycling horizon and then pre-shape and pre-compact the pre-pulverised material.
- Import, spread and compact new material to the required line and level on the existing road surface.

The specific requirements for each option are described separately in Section 6.2.2.1.

6.2.1.4 Equipment Selection

The recycling machine, bulk supply tankers and large primary roller are items of plant that are not generally used for normal road construction. In addition, equipment used to spread the low application rate of active filler usually specified for BSM needs careful consideration. Sufficient equipment must be available to ensure that a good quality BSM can be produced within the specified time limitations. The following paragraphs explain the basic requirements for the recycler, bulk tankers, spreaders for active filler and rollers for compaction.

i. Recycler

Bitumen stabilising agents are applied through a spraybar fitted to the recycler's mixing chamber. Tankers supplying the bitumen stabilising agent and water are coupled to the recycler to form the "recycling train" with the recycler acting as the locomotive. Recycling machines come in several different shapes and sizes, ranging from simple stabilisers to purpose-built recyclers with computer controlled application systems. Although the decision as to which machine is best suited to a specific project is primarily influenced by the work the recycler has to do, it is a critical decision since the outcome of the project will be dictated by the ability of the machine to

do the job. Recyclers used to treat the material with a bitumen stabilising agent must meet the following minimum requirements:

- Sufficient power to cut/mill into the pavement to the required depth whilst simultaneously pushing the recycling train.
- Sufficient volume in the mixing chamber to accommodate and mix the recovered material.
- Two independent micro-processor controlled application systems with separate spray bars, one for applying the bitumen stabilising agent, the other for applying water to increase the moisture content of the recycled material.
- A positive control system for maintaining the set-up of the recycler (depth of cut and relative inclination).

The number of recycling machines that are deployed on a project obviously has a significant impact on the production achieved. More than one pass is always required to cover the width to be treated in one shift, such as half-width of road or a single traffic lane. Production time is, therefore, lost when the recycler reverses to make the second (or third) pass. Such wasted time can be eliminated by deploying two (or more) recyclers, each working on a separate cut, one behind the other, thereby covering the required recycling width without having to reverse. The efficiency of such an operation is further increased by allowing the processing team (grader and secondary rollers) to start their work earlier.

ii. Bitumen Application System

The micro-processor controlled pumping system mounted on the recycler must be able to monitor and adjust the application rate of bitumen stabilising agent in accordance with the volume of material recovered as the recycler advances. This demands a sophisticated system that incorporates a flow meter. Systems required for applying bitumen emulsion are different from those required for applying foamed bitumen.

Bitumen Emulsion

The pump for drawing the bitumen emulsion from the tanker and pressurising it through to the spraybar, together with the injection nozzles fitted on the spraybar, need to be “bitumen emulsion friendly” to prevent the emulsion from breaking prematurely. Gear-type pumps and ultra-high pressure nozzles can cause an instant break (a so-called “flash break”). In addition to stopping production, such a scenario can cause irreparable damage to the application system.

Foamed Bitumen

Hot bitumen is drawn from the supply tanker and foamed in a series of expansion chambers fitted to the spraybar mounted on the mixing chamber. The ability of the system to produce a uniform and consistent supply of foamed bitumen from each of these expansion chambers is one of the primary determinants of the quality of mix produced. Poor or inconsistent foaming will produce a mix with many stringers (concentrations of fines and bitumen) and, in the worst extreme, blobs of sticky-shiny bitumen. Such a mix will not meet performance expectations.

Before a recycler fitted with a foamed bitumen system is accepted on a project, it should be checked to ensure that it has a proven track record of successful applications. Homemade and other systems, such as those that create foam by squirting water at a spray of hot bitumen (so-called “external foaming systems”) should never be used. Such systems produce inconsistent foam, resulting in a poor mix.

The system must have the capability to demonstrate that it is free from blockages, both prior to work commencing and at any stage during the operation. In addition, the system must be equipped with a “test nozzle” that operates under the same temperature and pressure conditions as the spraybar with the ability to produce a representative sample of foamed bitumen at any stage of the operation.

iii. Bulk Tankers

Tankers supplying hot bitumen, bitumen emulsion and water to the recycler should be sized in accordance with the scope of the work and geometry of the road. In general, single-chassis tanker units (capacity of ± 15 000 litres) are preferred on small projects and/or where the road alignment has low geometric standards. Large semi-trailer bulk tankers are usually used on large projects where the terrain is relatively flat.

All tankers should be inspected for leaks prior to coupling into the recycling train. A dripping leak of bitumen or water causes little harm while the train is moving but can give rise to wet or spongy spots when the train is stationary, for example, when checking the cutting tools.

iv. Spreaders for Applying Active Filler

Where active filler is spread on the road surface using a mechanical spreader, the low spread rate required when applying ≤ 1% by mass calls for a special type of spreader. Bulk tankers that are normally used to transport cement are often equipped with a pneumatic system to spread cement for stabilisation. Such systems may be acceptable for higher application rates, such as 3% or more, but cannot accurately spread the small quantities required for bitumen stabilisation. Special units that utilise a cellular wheel for metering the powder can accurately apply rates as low as 0.7% and are, therefore, ideal for spreading active filler on bitumen stabilisation projects.

v. Compaction Equipment

The material characteristics and thickness of layer being compacted dictates the type and number of rollers required for compaction. Three rollers are usually used to compact the recycled material:

- **Primary roller.** This is a single-drum vibrating roller that follows the recycler in order to compact the material before it loses moisture. This is the most important of the three rollers because it is responsible for ensuring that the layer, especially the lower portion, achieves the required density. The static mass of this roller is critical, dictated by the thickness of the layer, as shown in Table 6.1.

Table 6.1 Recommended Static Mass of the Primary Roller

Layer thickness (mm)	Static mass (ton)
< 150	12
150 – 200	15
200 – 300	20
300 – 350	25

A padfoot drum is normally fitted to the primary roller when compacting thick layers (> 150 mm). The indentations caused by the pads prevent the upper horizon of the layer from reaching a high density which then stops further applied energy from penetrating through to the material in the lower part of the layer. This is the “bridging out” phenomenon that can occur when a smooth drum roller is used, or when a roller with insufficient static mass is applied.

The relative coarseness of the material is also an important consideration when selecting the type and size of primary roller. Achieving the required level of density when compacting layers of fine- or coarse-grained materials can be difficult, often solved by trial and error with different combinations of rollers, for example, a padfoot with a PTR for fine material and a padfoot with a smooth drum for coarse material. Smooth drum vibrating rollers tend to introduce shear cracks in layers where the material is relatively fine and should, therefore, be avoided.

- **Secondary roller.** After the grader has worked the upper portion of the layer to produce the required shape and levels, a single (or tandem) smooth drum roller is used to compact the material in the upper horizon that was disturbed by the grader. Rollers with a static mass of between 10 and 12 tons are usually adequate for this work.

- **Finishing roller.** Once the grader work is complete and levels cut, a pneumatic-tyred roller (PTR) with a static mass of ± 20 tons is applied to achieve a tightly-knit surface finish.

6.2.1.5 Site Personnel

In situ recycling projects need people who know what they are doing. Although competent site management is essential, it is the Train Supervisor who is the key to a successful job. In addition, the operator of the recycler must be well trained and understand how to correctly set up the various systems and to recognise when things are not functioning correctly, especially when working with foamed bitumen. Furthermore, roller operators need special training, as does the final-level grader operator, who must understand that their respective tasks are different from those applicable to normal road construction.

In light of the cost of the stabilising agents, it makes no sense to tackle an in situ recycling job without the necessary qualified and experienced personnel, regardless of whether bitumen emulsion or foamed bitumen is used. The cost of training is insignificant compared to the cost of one wasted tanker-load of bitumen.

6.2.1.6 Cut Plan / Longitudinal Joints

The cut width of most recyclers is between 2.0 m and 2.5 m (the most common is 2.4 m). This means that more than one cut has to be made in order to recycle a single lane or half-width of road. Multiple cuts result in a series of longitudinal joints between each cut, requiring overlaps along the full length of each joint to achieve continuity.

Recyclers are large machines and maintaining a precise line of travel is practically impossible. It is, therefore, important to allocate a minimum overlap width of 150 mm between two cuts to make allowance for “wandering”.

The number of cuts required to cover the full width to be recycled is dictated by:

- Width of road to be recycled and cross-section details. Cambered roads should always be recycled in half-widths to retain the location of the crown and to maintain a uniform depth of recycling.
- Width of the drum fitted to the recycler.

A cut plan showing these details needs to be drawn up for each different width of road to be recycled on a specific project. The cut width of the recycler’s drum dictates the number of cuts required to recycle each different road width. For example, if an 8 m wide road is to be recycled in two 4 m half widths using a recycler with a cut width of 2.4 m, each half-width will require $4 \text{ m} / 2.4 \text{ m} = 1.667$ cuts. This means that the recycler will have to make 2 cuts that will overlap each other by some 800 mm in order to cover each 4 m half-width.

This example, drawn out in Figure 6.3, highlights the relevant details that need consideration.

In the example in Figure 6.3, the left half-width is to be recycled first. Two cuts are required to cover the 4 m half-width. However, the cut that falls on the centre-line should extend 150 mm over the centre-line for two reasons:

- The minimum width of overlap between two cuts is 150 mm.
- Crossing over the centre-line on the first half-width allows the cut line for the second half-width to follow the centre-line (incorporating the 150 mm overlap). In this manner, the crown on a cambered section is simply reinstated without the grader having to work across the centre-line.

The 150 mm overlap across the centre-line increases the recycled width to 4.15 m for the left half of the road and, as shown, the overlap between the two cuts reduces to 650 mm.

The second half-width (the right half) also requires 2 cuts but, since the total recycled width is 4.0 m, the overlap between the cuts is 800 mm.

The position of the trafficked wheel paths is also shown on the cut plan to check their location relative to the overlaps. Where possible, overlaps should be located outside the trafficked wheel paths. Trafficked wheel paths are nominally 750 mm wide with the centre located 750 mm from the edge of the lane.

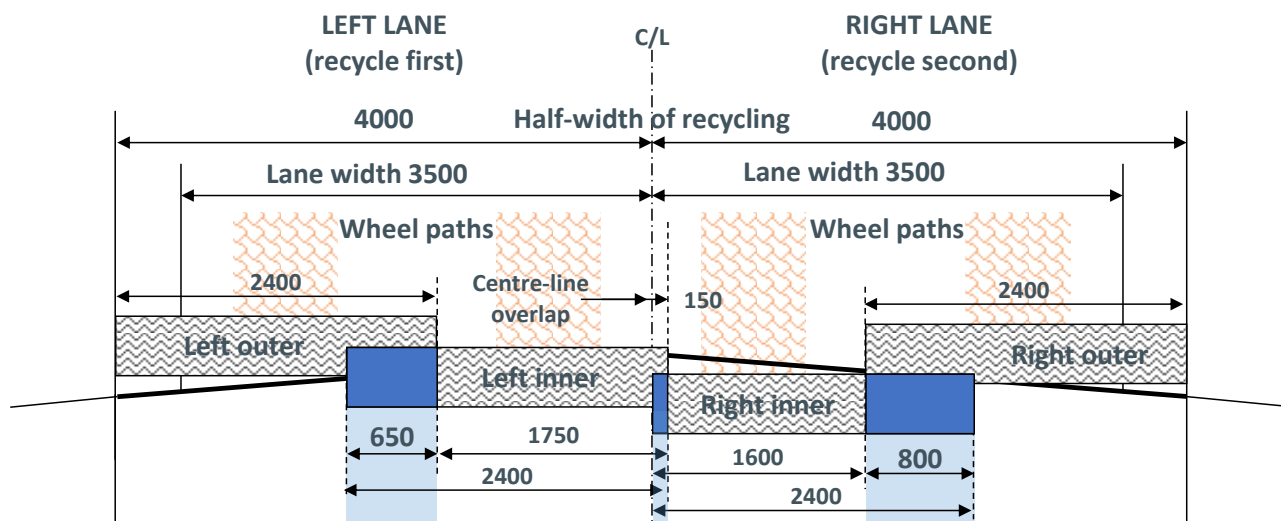

Figure 6.3 Example of a Cut Plan for Recycling a 2-Lane Road in Half-Widths

Once the cut plan has been drawn up, the overlaps dictate the respective application widths of water and bitumen stabilising agent for each cut. In the example above, the 2.4 m outer cuts for both half-widths are treated full-width, thereby ensuring continuous treatment across the trafficked outer wheel path. The outer wheel path is the “hot spot” for pavements and every effort must be made to avoid locating a construction joint in this area. The required application width for stabilising agents (and water) for the inner cuts reduces to 1750 mm for the left half and 1600 mm for the right half, as shown in Figure 6.3. However, to allow for machine wander, an additional 150 mm is treated on all overlaps. This increases the treatment width to 1900 mm for the left half and 1750 mm for the right half, as shown as shown in Figure 6.4. The spraybar settings for adding water and bitumen stabilising agent to achieve such application widths must be made accordingly.

The required application width is achieved by closing off some of the nozzles on the spraybar. The method used to close off nozzles is different for each machine manufacturer. This means that the operating instructions and application guidelines from the manufacturer of the machine used on the project must be understood and followed meticulously to achieve uniformity and continuity of application.

The example in Figure 6.4 shows the spraybar settings for a Wirtgen WR240 recycler. Eight switches in the operator’s cab control the 16 nozzles on the spraybars, paired alternatively: Switch # 1 controls Nozzles # 1 and 3, Switch # 2 controls Nozzles # 2 and 4, etc., an arrangement designed to ensure treatment across cut overlaps.

It is of paramount importance that a cut plan with spraybar settings shown in Figures 6.3 and 6.4 is compiled for each and every different width of road that is to be recycled on a project. **Such information must be drawn out and retained in the operator’s cab for easy reference.**

It is also important to recognise that the effective treatment width is not 8.0 m in the example shown in Figure 6.3. The 150 mm increase in treatment as “wander allowance” on each and every overlap increases the total width of treatment to an effective 8.45 m, an increase in consumption of stabilising agents of 5.6%.

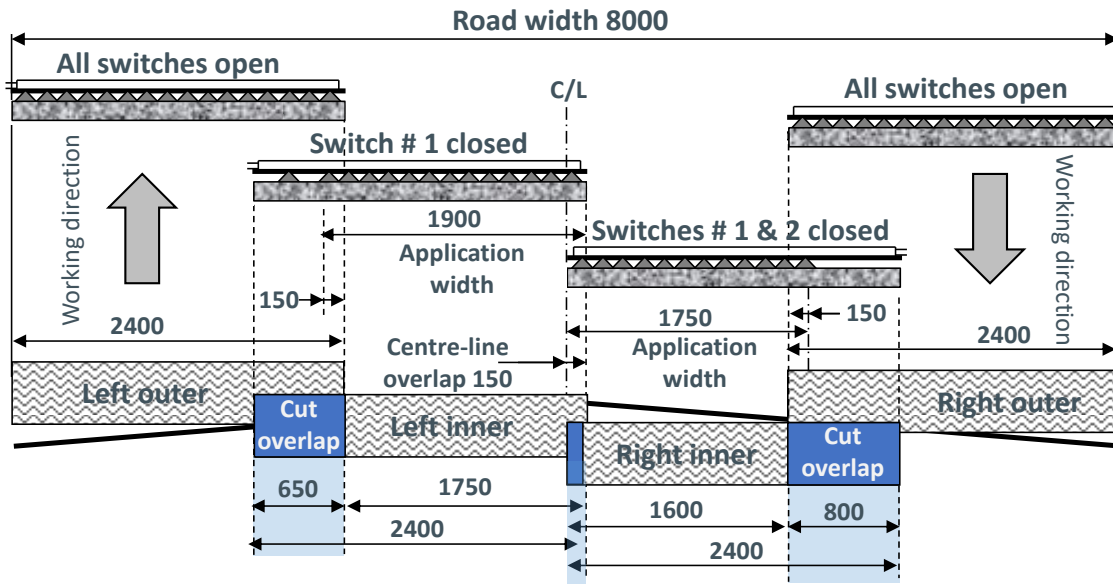

Figure 6.4 Example of the Spraybar Settings for a Wirtgen WR240

6.2.1.7 Traffic Accommodation

Provisions always need to be made for the safe accommodation of public traffic. Recycling work is usually carried out in half-widths, or by closing off only a portion of the existing road. Correct signage, delineators and traffic control measures all need to be in place before any work can start.

Where foamed bitumen is applied and the full road width opened to traffic when the work is complete, only the section of road that is recycled needs to be closed off whilst work is in progress. When bitumen emulsion is applied, the half width must remain closed until the emulsion has broken before opening to traffic. This normally takes at least 48 hours, dictated by weather conditions and the type of emulsion applied.

6.2.1.8 Logistics

The logistical requirements for feeding a recycling operation with bitumen, active filler and water must receive due attention. An average daily production rate of 5 000 m² (about 1.4 km of 3.7 m wide lane) can be expected from a modern recycler, regardless of the depth of cut. Assuming a cut depth of 250 mm, an average density of 2 100 kg/m³ and application rates of 2.2% residual bitumen and 1% active filler (by mass) translates to the daily material consumption requirements shown in Table 6.2.

Table 6.2 Example of the Daily Demand for Bitumen and Active Filler

Stabilising Agent	Bitumen Emulsion	Foamed Bitumen
Bitumen	96 ton (60% residual)	58 ton
Active filler	25 ton (500 x 50 kg pockets of cement, or 1 000 x 25 kg bags of hydrated lime)	

Where the site is distant from the source of supply, temporary storage facilities need to be established to ensure a consistent supply, thereby reducing the potential for delays caused by material shortages.

6.2.2 Executing the Work

Weather conditions dictate when recycling with a bitumen stabilising agent can proceed. Temperatures (especially the temperature of material to be recycled), wind velocity and anticipated rain are the important factors that need to be considered.

The work involved in recycling to create a new pavement layer can be divided into three separate processes:

- Preliminary work required to prepare the road for recycling.
- Recycling operation, including material recovery, mixing, placing and primary compaction. This is normally accomplished in a single pass with a recycler that recovers the material from the existing road, mixes it with additives (water, active filler and bitumen stabilising agent) and places it back into the cut from where it originated. The primary roller follows immediately behind the recycler compacting the material.
- Processing the pre-compacted material. After recycling / compacting all the cuts required to recycle the designated width of treatment (lane width or half road width), a grader is used to achieve the required line, level and surface shape. This is followed by further compaction and finishing.

6.2.2.1 Preliminary Work

All work that precedes the recycling operation must be completed before the recycler starts working. Such preliminary work falls under one of the following headings:

i. Cleaning the surface of the existing road

In addition to removing all debris and foreign matter, any standing water must be broomed off the road surface before any recycling work is undertaken.

ii. Pre-milling

Where required, pre-milling of asphalt must be undertaken using a milling machine, not a recycler. In addition to pre-shaping the surface of the existing road, a portion of the asphalt material is sometimes removed to ensure that final surface elevations (i.e. after recycling and applying the new surfacing) match existing elevation constraints, such as kerbs, intersection tie-ins, etc.

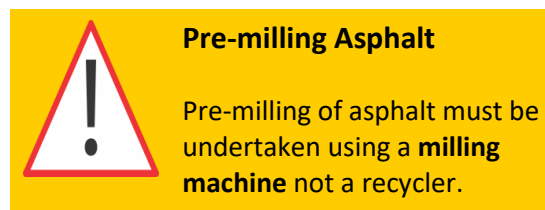

As described in Section 6.2.1.3 iv, partial-depth pre-milling without removing the RAP is sometimes necessary to break down severely distressed asphalt. The purpose of such pre-milling is to eliminate oversized particles such as asphalt chunks. Note that to achieve the required material breakdown (fragmentation), the depth of pre-milling must be less than the thickness of asphalt.

iii. Pre-pulverising the material in the recycling horizon

Pre-pulverising an existing pavement should only be considered when the following conditions are encountered:

- Surface irregularities are significant relative to the depth of recycling or the surface is so badly out of shape that the recycler will be unable to achieve a consistent depth of cut.
- The recycling depth includes pavement layers that require more power than the recycler can deliver to break down the material whilst simultaneously achieving sufficient advance speed. Sufficient advance speed is important as this dictates the flow rate through the spraybars which, in turn, determines the operating pressures. Such tough milling conditions are usually associated with thick layers of aged asphalt and, sometimes, previously cemented layers.
- When material in the recycling horizon needs to be cross-blended to achieve uniformity. This situation is normally only encountered where the road was previously widened using different materials from those used in the original pavement, and is discussed further below.

- When the material needs to be chemically modified prior to stabilising with bitumen. This is normally confined to modifying plastic material (PI > 10).

Where pre-pulverising is deemed necessary, the depth of cut must be carefully controlled to ensure that a thin layer (normally 50 mm) of the existing pavement remains, which is recovered when the layer is stabilised. In addition, a water cart should always be coupled to the recycler and water added whilst pre-pulverising so that the loosened material can be compacted and levels cut to provide the recycler with the correct surface shape for the second stabilising pass. The density requirement for compacted pre-pulverised material is normally 95% of the Maximum Dry Density (MDD).

Density of pre-pulverised material

i The density requirement for compaction of the pre-pulverised material is normally 95% of the MDD.

It must be appreciated that recycled material always bulks (increases in volume). This means that material recovered by recycling can never be compacted back into the cut to achieve the original surface level; it will always be higher. Such bulking is primarily due to the increase in volume of the asphalt component that changes from a fully-bound material (typical density in excess of 2400 kg/m³) to a granular type of material (compacted density in the order of 2000 kg/m³). Layers of granular material in old pavements also bulk when recycled since years of trafficking have resulted in an increase in density, causing permanent deformation. Such bulking is beneficial because it provides a working windrow for the grader.

The consequence of bulking is that, after the pre-pulverised material has been shaped by grader and compacted, the surface levels will always be higher than the original road levels. Such an increase in elevation must be recognised when the recycler makes the second stabilising pass; the depth of cut must be increased to achieve the correct horizon. In addition, the application rate for the bitumen stabilising agent must be adjusted to reflect the required (unbulked) layer thickness. These requirements introduce a level of complexity that is often ignored by site personnel and it is for this reason that **pre-pulverising should only be undertaken when absolutely necessary**.

iv. Importing material

Some projects require material to be imported and spread on the existing road surface prior to recycling. Such material is normally hauled to site and dumped prior to adding water, mixing and placing by grader to the required surface shape. The material is then compacted to a nominal 95% of MDD. Alternatively, where the imported material is a crushed stone product (graded crushed stone or crusher dust), the material can be pretreated with water in an off-site mixing plant, hauled to site, paved on the existing road surface and compacted prior to being recycled together with material from the underlying (existing) pavement.

Where the existing road is so badly out of shape that the thickness of the imported layer varies excessively, the existing pavement should be pre-pulverised and the material generated spread, shaped and compacted prior to importing and placing the new material (as described in Chapter 3 and shown in Figure 3.11).

Material import and preparation is normally undertaken immediately before recycling. When working in half-widths, such additional material often results in a vertical step on the centre-line. Where this presents a safety hazard, consideration should be given to recycling both half-widths during the same shift. However, this is only possible when applying foamed bitumen that allows the first half-width to be trafficked immediately after completion.

The surface level / cut horizon implications described in the above paragraph for pre-pulverising are equally relevant when working with imported material.

v. Spreading active filler

Active filler must be accurately spread on the road surface immediately prior to commencing work with the recycler. To prevent losses due to wind-blow or other disturbances, such as reversing the train over previously spread powder, spreading is normally confined to one cut width at a time rather than spreading over the entire width that will be recycled that day.

The application rate for active filler (cement or hydrated lime) is always low, $\leq 1\%$ by mass. Recyclers do not move or mix material in the horizontal plane. The maximum particle movement in the horizontal plane is 200 mm transverse and 500 mm longitudinal. Therefore, accurate spreading is very important. Spreaders equipped with a small cellular wheel are ideal for achieving the degree of accuracy required. However, where such equipment is not available, hand-spreading of pockets is an option, but only under close supervision. The area to be covered by each pocket of cement or lime must first be marked accurately on the road surface. The pockets are then opened and the contents of each pocket carefully spread as a layer of uniform thickness within the confines of the respective grid. Cement slurry injection using a specialised mixer incorporated into the recycling train is another option but the cost of such equipment limits its use to those sites demanding a dust-free application.

vi. Positioning the guideline

A highly-visible guideline must be positioned to assist the operator of the recycler to maintain the required line of cut. A brightly-coloured fish line is normally used, positioned by measuring a constant offset from the level control poles. Such a guideline is required for each and every cut.

6.2.2.2 The Recycling Operation: Material Recovery, Mixing, Placing and Primary Compaction

i. Prestart checks

Before starting work, the recycler and other machines must be checked. In addition to normal mechanical checks that are carried out as routine, for example, lubrication levels, tyre pressure, etc., the application systems on the recycler must be checked before work starts every day.

The procedure to be followed for checking the application systems is specific to the recycler being used; each machine manufacturer has a different system. The instructions / guidelines from the manufacturer for maintenance and checking must be followed before the machine starts working. Such checks must be diligently carried out by a suitably authorised individual (normally the Train Supervisor), properly recorded, signed off and filed as part of the Daily Production Report. These records are invaluable should there be any problem related to defective work.

ii. Assembling the recycling train

An appropriate recycling train is first assembled with tankers connected to the recycler. A typical recycling train for treating with bitumen is shown in Figure 6.5.



Figure 6.5 Typical Recycling Train for Bitumen Stabilisation

Regardless of whether bitumen emulsion or foamed bitumen is applied, the bitumen feed pipe should have a minimum internal diameter of 100 mm and the length minimised by locating the bitumen tanker immediately in front of the recycler.

The water tanker can be coupled ahead of the bitumen tanker and be pushed, requiring the bitumen tanker to be fitted with a front push-block, or be pulled behind. Either location requires a long flexible pipe to feed the water to the inlet coupling that is located at the front of the recycler. To prevent dragging on the ground, this pipe must be securely attached to the side of the bitumen tanker (when the water tanker is pushed) or the recycler (when the water tanker is pulled). Fitting a valve at both ends of this long feed pipe prevents large volumes of water escaping when changing water tankers.

All feed pipes operate under suction and must, therefore, be capable of withstanding negative pressure which precludes the use of “lay-flat” hoses. In addition, for the reasons explained in Section 6.2.1.4 iii, the tankers, feed pipes and connections must be free of leaks.

Once both tankers have been coupled into the train and feed pipes attached, the water and bitumen systems must be primed. This requires all air to be bled from each system, from the outlet valve on the tanker to the injection nozzles on the spraybar. Failure to do so results in starvation when recycling begins and several metres of road will receive no additives when the recycling operation starts.

iii. Preparing to start recycling

Once all the pre-start checks have been carried out and the train positioned to start recycling, the on-board computer and application settings must be checked to ensure that the correct data has been entered and that the spraybar nozzles for the required application width have been selected. Such checks must be carried out by the Train Supervisor in accordance with the requirements stipulated by the manufacturer of the recycler.

iv. Operating the recycler

Requirements for the correct method of operating a recycler is both machine and manufacturer specific. The following sections, therefore, address the overall requirements rather than focus on the details that must be obtained from the machine manufacturer.

Line of travel. The operator of the recycler must adhere to the required line of travel by diligently following the guideline. Any departure by more than 150 mm from the required line of travel is extremely difficult to rectify since it involves treating a thin strip of material, which cannot be done using a large machine.

Advance speed. The speed at which the recycler advances is critical. The advance speed is one of the primary determinants of the grading of the material recovered from the existing pavement, as well as the mix quality. The effect of the advance speed are given in Table 6.3.

Table 6.3 Effect of Advance Speed on Grading and Mix Quality

Speed of advance (m/min)	Grading of recovered material	Quality of the mixed material
< 6	Finer	Poor ¹
6 – 10	Acceptable	Good
> 10	Coarser	Poor ²

Notes:

1. Poor mix quality due to insufficient injection pressure through the spraybars (dictated by the flow rate)
2. Poor mix quality due to insufficient time of retention in the recycler’s mixing chamber

When starting to recycle, the machine must accelerate as quickly as possible to the optimal speed of advance (8 m/min) to minimise the distance covered whilst accelerating and the pressure in the spraybars is below the

minimum required. Similarly, when the material encountered in the existing pavement becomes increasingly tough to recycle, the speed of advance will reduce along with the mix quality. Such a scenario demands that the material is first pre-pulverised before it can be effectively stabilised (see Section 6.2.2.1 iii).

Note that some recyclers have built-in systems that prevent the application system from operating when the pressure drops below a certain threshold. Site personnel must, therefore, be familiar with the operating procedures published by the relevant machine manufacturer and, where necessary, should seek advice.

Cut depth. The location of the cut horizon relative to the final surface horizon must be checked at the start of each new cut and, thereafter, at regular intervals (± 50 m) as the recycler advances. Excavating a small hole against the edge of cut to measure the cut depth is not recommended for two reasons:

- The surface on which the recycler runs is unlikely to be the same as that produced by the grader when cutting final levels.
- The one side of the recycler runs on bulked material when making the second and subsequent cuts.

The required cut depth is best achieved by pushing a T-bar into the loose material behind the recycler, on both sides of cut, and measuring down (dipping) from a stringline pulled between the relevant marks on the level control poles used to cut final levels. This simple procedure is shown in Figure 6.6.



Figure 6.6 Checking the Cut Depth by Dipping

v. Applying bitumen emulsion

Recycling with bitumen emulsion is often described as being easier than foamed bitumen. This is because a tanker containing the emulsion is brought to site, connected to the recycler and used without the inconvenience of heating and having to conduct a long list of checks. These claims are largely true if the following concerns are addressed:

- Bitumen emulsion is manufactured in a specialised factory environment and brought to site in a bulk tanker and either used immediately by connecting the tanker to the recycler or pumped into a stationary tank for temporary storage. All haulage units and storage tanks must be dedicated to the sole use of one type of emulsion. If previously used for a different type of emulsion (or other bituminous product) the tank must first be thoroughly cleaned before being used. Combining two types of emulsion, even in small concentrations, can cause the emulsion to break prematurely.
- Extreme care must be exercised to ensure that the correct emulsion is brought to site. Each tanker must have a delivery note issued at the point of loading on which is stated the details of the product and the loading conditions. It is recommended that a small sample is taken from each tanker load and retained for testing should such tests be required.
- Recommendations from the manufacturer concerning storage and usage conditions / limitations must be meticulously followed to prevent product deterioration or premature breaking.

- To reduce viscosity and facilitate pumping, bitumen emulsion is normally applied through the recycler at 60 °C. This means that the emulsion often needs to be heated on site. Such heating must be undertaken under strict controls, following the manufacturer's guidelines. As a minimum, the emulsion needs to be circulated in the tank whilst being heated. Failure to follow these guidelines will inevitably result in a premature break and loss of product.

vi. Applying foamed bitumen

Foamed bitumen is "manufactured" in a series of expansion chambers positioned equidistant on a spraybar fitted to the mixing chamber. Provided no anti-foaming agents are present, all but the hardest bitumen can be foamed and the foaming characteristics (expansion ratio and half-life) are specific to a particular bitumen. These foaming characteristics are influenced by several factors, all of which can be regulated to a varying extent on site.

Although these factors are explained in Chapter 4: Mix Design, they are summarised below with particular emphasis on practical site considerations:

- Temperature of the bitumen. In general, the higher the temperature, the better the foaming characteristics due to the reduction in viscosity of the bitumen. However, bitumen should never be heated above 195 °C. In addition to hardening the bitumen, such high temperatures can damage the more sensitive components of the application system.
- Temperature of the water used for foaming. Warm water requires less energy than cold water to effect the change in state from liquid to vapour as the bitumen foams.
- Operating pressure in both the bitumen and water supply systems. Operating pressure is a function of flow and these two systems must be interlinked and micro-processor controlled by the speed of advance of the recycler. The higher the pressure, the more uniform the foam due to better "atomising" of both liquids as they enter the expansion chamber through their respective jets. Conversely, the lower the pressure, the less uniform the foam.
- Amount of water injected into the bitumen to create the foam. The "optimal" addition of water is initially determined in a laboratory. However, site conditions differ from those in the laboratory and water addition often requires adjusting to achieve the best foam on site, normally a reduction of 0.5%.

The foam produced in the expansion chambers on a recycler is always an improvement on that produced in a laboratory. The main reason for this phenomenon is the higher operating pressure on a recycler (5 to 10 bars), compared to a laboratory unit (± 3 bars). In addition, the temperature of the water used for foaming on site is usually warmer than tap water in an air conditioned laboratory. As a result, it is often possible to achieve a workable foam at bitumen temperatures lower than the optimum determined in the laboratory, but never less than 160 °C.

It is important to always check the foaming quality of each load of bitumen using the test nozzle. Initial checks are normally made whilst the test nozzle is used to bleed air from the system. Provided an acceptable foam is observed, the tanker can be accepted and work commence. The foam quality always improves after the system has been in operation for a few minutes and a consistent operating temperature and pressure has been reached.

Note: The flow rate and operating pressures on a recycler are significantly higher than those on a laboratory unit. Foaming characteristics can, therefore, not be measured using the test nozzle on a recycler, they can only be estimated.

vii. Applying water (increasing the moisture content)

The water spraybar is used to add sufficient water to the material in the mixing chamber to achieve the required moisture content, one of the most important variables that influences the end-product. The effectiveness of bitumen dispersion, the compaction effort required to achieve the target density and the potential for surface cracking are all significantly influenced by the moisture content of the material, as well as the uniformity of the moisture content in the recycled material.

Varying moisture conditions in the in situ pavement must be expected. Research undertaken by the CSIR during the 1980's showed that material beneath a bituminous surface will always be moist and that the "equilibrium moisture content" (EMC) relative to the OMC of the material is predictable. Hence, the EMC can be expected to be reasonably consistent where the material is similar. However, variations must be anticipated when the following conditions are encountered:

- Cracks in the surfacing allow rainwater to penetrate into the underlying pavement layers, concentrating in the vicinity of the crack.
- Where the road has unsurfaced shoulders, an increase in moisture content at the high side of super elevated curves should be expected after rain has fallen.
- The pavement material at the bottom of sag vertical curves is always more moist than elsewhere in the pavement.

In addition, pavements with natural or crushed stone bases with numerous deep asphalt patches may be prone to saturation when recycled. Mixing RAP from patches and pavement layers with a granular base material produces a blend that has a lower OMC value than the original base material. However, this is normally only encountered where the EMC in the base is close to the OMC, a condition most likely to be encountered during wet seasons and where the surfacing is badly cracked.

It is, therefore, impractical to accurately predict variations in the moisture content of the material in the recycling horizon of an existing pavement, regardless of how many tests are taken. As is standard practice for all layerwork construction, the required moisture content of the recycled material is approximated by varying the addition of water whilst recycling and constantly assessing the material "by feel". This requires the operator to vary the amount of water added when instructed by the Train Supervisor who has sufficient experience to be able to gauge moisture content. Equipping the Train Supervisor and operator with walkie-talkie radios allows instant communication.

Where the in situ moisture content of the material to be recycled is above the OMC, the material must first be dried back before it can be treated. This is normally achieved by pre-pulverising on a warm day and leaving the loose material open to dry. When the moisture content has reduced sufficiently, the pulverised material must be shaped and pre-compacted before being stabilised.

viii. Visual Observations

The visual appearance of the material immediately behind the recycler usually indicates whether the machine is set up and operating properly. A gradual change in colour across the cut width normally indicates that one end of the drum is lower than the other (as can be seen in Figure 6.7). A lighter appearance (right side of picture) indicates an under-application of water and bitumen stabilising agent, caused by the drum penetrating too deep into the pavement. A darker colour (left side) indicates an over-application due to the drum not penetrating deep enough.

Bitumen stabilised materials are not sticky and should, therefore, not adhere to the rear wheels of the recycler. Figure 6.7 illustrates what the rear tyres should look like when applying either foamed bitumen or bitumen emulsion. Material sticking to the rear wheels when applying foamed bitumen indicates that the mix is poor and the cause must immediately be determined and rectified. Such poorly mixed material also sticks to the drum of the roller, causing material build-up and further problems.

ix. Placing the material behind the recycler

As the mixed material exits the mixing chamber it is struck off by the rear door. Sufficient pressure is applied to the rear door to ensure that the material is levelled off with no valleys or ridges. The rear tyres of all wheel-mounted recyclers run on the outer edges of the recycled material as the machine advances, compacting the two strips of material under the tyres, but leaving the material between these strips in a loose state, as shown in Figure 6.7.



Figure 6.7 Mixed Material Exiting behind the Recycler

x. Construction Joints

A construction joint is formed across the width of cut every time the recycler stops. Similar to construction joints in all other pavement materials, for example, asphalt, attention to detail is required to ensure continuity of treatment across the joint, ensuring similar material properties on both sides of the joint.

As previously explained, recyclers are not all the same. Machines from different manufacturers function differently at start-up, especially with regards to the application systems for water and bitumen stabilising agents. For this reason it is essential that the manufacturer's guidelines are understood and followed meticulously to avoid a "dry joint" that inevitably results in a premature failure.

6.2.2.3 Primary Compaction

It is imperative that the material between the recycler's wheel tracks is compacted to at least the same density as that in the wheel tracks before the grader is allowed to start work. Failure to follow this simple requirement results in a permanent density difference between the material in the recycler's wheel tracks and that between the wheel tracks. This is because the drum width of standard rollers is ± 2.1 m which is always greater than the width of the uncompacted material between the wheel tracks. If this loose material is cut to the same elevation as the compacted material in the wheel tracks, subsequent rolling always bridges-out across the denser material in the wheel tracks. The material in the recycler's wheel tracks will, therefore, always be at a higher level of density than the material between the wheel tracks.

Since the middle of the recycled cut is normally aligned with the trafficked wheel paths, such a scenario is a recipe for a premature failure.

The primary roller must, therefore, follow behind the recycler compacting the material, normally in sequential sections of ± 50 m in length. To prevent bridging from unrecycled material, the roller must travel exclusively within the confines of the recycler's cut, or, stated differently, the roller's drum must not wander beyond the edge of cut. Several forward / backward passes are made with the roller operating in high amplitude vibration mode. To promote deep penetrating compaction, the operating speed of the roller should be restricted to a maximum of 3 km/hr (50 m/min). To prevent the material from drying out, primary rolling must follow closely behind the recycler.

The number of passes the roller needs to make in order to compact the material is dictated by several parameters:

- Mass of the roller and the compaction energy applied by means of vibration.
- Roller operation, especially speed of travel and rolling pattern.
- Support provided by the underlying pavement (stiffness).

i **Wheel Tracks**
The material between the recycler's wheel tracks must be compacted to at least the same density as that in the wheel tracks before the grader is allowed to start work.

- Nature of the material, especially the grading.
- Moisture content and uniformity of moisture distribution in the material.
- Thickness of the layer being compacted.
- Target density, for example, 100% of MDD.

The number of roller passes required is usually determined when constructing a Trial Section. The density of the material is physically measured at the same location after every two passes made by the roller (a forward and a reverse pass). Such Trial Sections indicate the number of roller passes required to achieve the target density on that particular section of road using a specific roller. If the conditions change, for example, if the material is coarser, then more or less roller passes may be required.

When using a padfoot roller, the depth to which the pads penetrate into the material reduces as the density of the material increases. This “walking out” phenomenon is normally visible and is sometimes used as an indicator of sufficient roller passes having been made and the required density achieved.

An alternative, and strongly recommended, method for determining the number of roller passes required for compaction is to install an “Intelligent Compaction” system on the primary roller. These systems are becoming more popular on recycling projects because they indicate when the maximum density has been achieved, regardless of the conditions. Details of these systems may be obtained from the various roller manufacturers.

6.2.2.4 Processing the Pre-Compacted Material

The grader only starts working when the primary compaction is complete for all cuts required to recycle the required width, such as a single lane, half-width, etc.

The first task for the grader is to rework the uppermost 50 to 75 mm of the layer in order to eliminate steps and other deformations remaining after primary compaction. This work is always initiated by a water cart spraying sufficient water on the exposed surface to achieve a moist state. When stabilising with bitumen emulsion, such moistening must be achieved by spraying with diluted emulsion, not neat water (see Sections 6.3.1 iii and 6.3.2). Blading moist material onto a dry surface results in a plane of discontinuity, encouraging the upper layer to delaminate from the underlying material.

Furthermore, whilst the grader is performing the tasks described below, rollers must be kept off freshly-cut surfaces. To eliminate the risk of creating a smooth surface that can lead to a delamination, secondary compaction must be delayed until the grader has finished placing the material.

The required grader work, compaction and finishing is described in the following seven steps:

- Step 1.** Use the level control poles to determine the depth to which the grader must cut in order to remove all steps and/or indentations in the surface.
- Step 2.** Use the water cart to spray the surface over the full recycled width. Where necessary, make 2 (or more) passes to thoroughly wet the material.
- Step 3.** The grader cuts material from the higher side of the recycled width to the lower, leaving the material in windrow on the shoulder (or adjacent lane). The inclination of the cut must conform to the required cross-fall (final surface levels) and the depth of cut controlled by dipping. The cut surface is then checked for any lines of loose material. If detected, the grader must make a second pass, cutting to the underside of the loose material, adding the bladed material to that in the windrow.
- Step 4.** The surface is then given a generous spray of water (or diluted bitumen emulsion when the material is a BSM-emulsion) immediately before the grader blades the windrowed material back over the cut surface, spreading it as a layer of uniform thickness. The operator needs to exercise extreme care to ensure that a thin lens of treated material remains on the shoulder, thereby avoiding any contamination.
- Step 5.** The spread material is then compacted using a smooth drum vibrating roller, often working together with a pneumatic-tyred roller. Since the thickness of this layer is relatively thin, the roller that is normally used (± 10 ton static mass) should be capable of achieving the required density by making between 5

and 7 passes. Similar to the primary compaction process described above, rolling must be confined to the recycled width to prevent bridging from unrecycled material.

Step 6. As soon as the secondary compaction is complete, the grader cuts final levels, starting on the high side and leaving the windrow of bulked material on the shoulder. The smooth drum vibrating roller follows behind the grader. Once complete, the surface is inspected for uniformity.

Where there are numerous scratch-lines (caused by the grader dragging large particles), the grader blade is set approximately 5 mm above the road surface and the windrow bladed across the recycled width and then back again onto the shoulder where it is picked up and removed from site. This exercise “drops fines” into the voids on the surface.

Step 7. The surface is then thoroughly moistened and the pneumatic-tyred roller used to finish off. The roller is operated at a speed of between 10 and 20 km/hr, rolling in parallel passes across the full recycled width. Whilst rolling, sufficient water (or diluted emulsion) is added to generate a mild slush (mud) that the tyres spread laterally, thereby creating a tightly-knit surface finish. Such a finish is required if the layer is to be subjected to early trafficking. To provide additional protection against surface degradation (ravelling) under traffic, diluted bitumen emulsion (10 to 15% residual bitumen) can be substituted for water in the slushing process when stabilising with foamed bitumen.

Care must be taken to ensure that the amount of water (or diluted emulsion) sprayed on the road surface is sufficient to generate “enough” slush. Too much can result in excessive mud generation which dries as a layer of fines on the surface and subsequently has to be removed before the surfacing is applied.

Note: The slushing process described above is purely a finishing operation and is very different to the slushing process required to achieve density when constructing a G1 base.

6.3 IN SITU TREATMENT USING CONVENTIONAL EQUIPMENT (BSM-EMULSION ONLY)

This section describes the operations involved when using conventional construction equipment to recover material from the existing pavement and stabilise it with bitumen emulsion. This method of construction cannot be used with foamed bitumen because it offers no opportunity for mixing within the short life span of bitumen in its foamed state.

The method of working described in this section was developed and refined on numerous projects undertaken in South Africa over the past forty years. Several roads that were treated with bitumen emulsion have outlived their service expectations by many years and are currently subjected to daily traffic volumes that far exceed what they were originally designed to carry. Some of those projects form part of the database that was used to develop the heuristic model for the structural design of BSMs (the Pavement Number method explained in Chapter 5).

This section focuses on the preparation and mixing activities which constitutes the main difference in construction between using recyclers and conventional equipment to reuse existing pavement material for BSM-emulsion layers. Although recyclers have generally replaced conventional equipment for in situ treatment, the use of conventional equipment remains an option and is still used on projects where the depth of treatment is 150 mm or less.

6.3.1 Equipment Selection

Sufficient watering, mixing and compaction plant in good working order must be available to ensure that the specified quantities of water, active filler and bitumen emulsion can be adequately mixed and the required degree of compaction obtained within the allowed working period. Various items of constructional plant can be provided to cater for different methods of material preparation, processing and subsequent compaction depending on the project requirements. These are described in the following sections.

i. Heavy Duty Motor Grader

A heavy duty motor grader (power > 120 kW and operating weight > 14 tons) is an essential item of plant, irrespective of the combination of any of the other items of plant used. This grader is required to pre-shape the material prior to treatment, for processing the material and, thereafter, to cut final levels once all the material processing is complete. Processing by grader includes mixing the material prior to treatment and mixing in the active filler and bitumen emulsion. Depending on the volume of material being mixed and the quantity to be treated in a single shift, more than one grader may be required.

ii. Milling Machine

On some projects a milling machine may be more effective than a grader to break up an existing asphalt wearing course and/or an existing stabilised material to produce material for subsequent treatment with bitumen emulsion. A milling machine is generally more cost effective when a previously stabilised layer has failed, but remains bound between the failure areas, with cube crushing strengths well in excess of 5 MPa, or when an asphalt layer is severely cracked and the large chunks need to be pulverised. When in situ material is to be augmented with imported material, a milling machine can also be effectively used to blend the two materials after the additional material has been levelled out on top of the in situ material and pre-shaped with a grader.

Alternatively, layers that have developed high in situ strength can be broken down using a 'woodpecker-type' breaker fitted to an excavator. The resulting chunks of pavement material can then be transported to an off-site crusher to be broken down before transporting back to the road for further processing.

iii. Water Tankers

Self-propelled water tankers with a minimum capacity of 15 000 litre are essential plant items for the successful construction of a BSM-emulsion. In addition to supplying the bitumen emulsion for mixing, water tankers are required to ensure proper finishing of the treated layer of material after the initial mixing and processing stage is complete. Sufficient water tankers must be provided to ensure that the processing of the material is a continuous procedure with no delays.

The water tankers involved with emulsion treatment of material should only ever transport emulsion in various stages of dilution as the need dictates. **At no stage in the process of material treatment should water to be added to the material on its own.** To increase the moisture content of the material, moisture can only be added in the form of a diluted bitumen emulsion with 10%, 15%, 20%, 30% or 40% residual bitumen, as described in Section 6.3.2.

Note that in hot arid regions, especially when importing material that has been standing in stockpile, or with absorptive materials, a premature break can be avoided by pre-wetting the material before applying the emulsion.

All water tankers used for emulsion treatment must be equipped with a circulating pump system whereby the diluted emulsion can be circulated after standing for an extended period and for circulating during the dilution process. Water tankers must not be fitted with a conventional spraybar but with special valves, (for example, an Audco valve), which does not easily clog. The application of the diluted emulsion is a cold process and there is always the potential for the emulsion to break and cause blockages. Tankers must be properly flushed should they need to stand empty for extended periods, including overnight.

iv. Static Storage Tanks

Static tanks should be provided to cater for storing sufficient bitumen emulsion for the needs of the project. Normally such tanks have a capacity of between 60 000 litres and 120 000 litres. The static tank must be fitted with a circulating pump system to enable the stored emulsion to be properly circulated from time to time, especially if no emulsion has been drawn or added for more than 2 days.

6.3.2 Bitumen Emulsion

At no time should a standard emulsion with 60% residual bitumen content be applied to the layer of material being treated with conventional construction equipment.

Such undiluted bitumen emulsion is inclined to break too quickly, particularly on a hot day, thereby preventing the emulsion from being thoroughly mixed throughout the full depth of the layer of material. Dispersion amongst all the granular particles within the layer will not take place when the emulsion breaks too early and a poorly treated layer results, leading to premature failure of the layer. The coating of particles with bitumen emulsion ensures the successful construction of the BSM layer. As a consequence, the in situ moisture content of the untreated layer must never be so high that it cannot accommodate an emulsion that has been diluted to a residual bitumen content between 30% and 50%.



Addition of Bitumen Emulsion
 Bitumen emulsion added without dilution with water will be inclined to break too quickly, particularly on a hot day. To prevent the emulsion from breaking whilst being diluted, water is always added to the emulsion, never emulsion to water.

To prevent the emulsion from breaking whilst being diluted, **water is always added to the emulsion**, never emulsion to water.

A 60% anionic stable grade bitumen emulsion is normally diluted by the addition of clean water to at least a 40% residual bitumen content (40% residual bitumen to 60% water) and preferably to a 20% residual bitumen content for addition into gravel materials. On rare occasions the moisture content of the in situ material will be high, necessitating the use of diluted emulsion with a residual bitumen content of 50%, but this should be the exception and not the rule. The dilution of the bitumen emulsion is detailed in Table 6.4. The product must be circulated whilst adding the water.

Table 6.4 Dilution of Bitumen Emulsion

Percentage residual bitumen content in the diluted emulsion (%)	Litres of water to be added to 10 litres of standard bitumen emulsion (60% residual bitumen content)
50	2
40	5
30	10
20	20
10	50

6.3.3 Mixing

Where the layer to be treated was previously stabilised, the rippers of the grader can be used to break up the layer, provided the in situ strength is low enough to permit such an operation.

Blade-mixing by grader is undertaken by using the mould board to move the material from side to side. This mixing process is often supplemented with the use of ploughs and/or rotavators. Where the width of treatment restricts the horizontal movement of the material, use should be made of the grader scarifiers with specially designed “shoes” welded onto the shanks. Such shoes are in the shape of a horizontal “V”, with the sharp end of the V pointing in the direction of travel. The shanks with their V-shaped shoes are lowered onto the layer being treated and the “fast forward” gear of the grader adopted to plough through the material. In this manner, the material is pushed aside, ensuring that proper mixing is achieved, even when working in confined widths.

Standard bitumen emulsion diluted to a residual bitumen content of 30% to 40% is applied in several applications onto the material after the active filler has been mixed into the material. Water tankers are used to apply the bitumen emulsion and the grader(s) must travel directly behind the water tanker, immediately covering the freshly sprayed emulsion with material, thereby preventing the emulsion from breaking. The volume of bitumen emulsion applied is determined by the residual bitumen content required, expressed as a percentage by mass of the finally treated layer. Should weather conditions be particularly hot or dry then the bitumen emulsion must

be diluted to a bitumen content that is less than 30% with proportionately more water added to all or to some of the water tankers.

Care should be taken to ensure that the diluted bitumen emulsion is applied in such a way that no rivulets are formed and that the bitumen emulsion does not run off the layer before it has been mixed in.

During mixing, attention must be paid to the fluid content of the mix. The fluid content is the total quantity of fluid in the mix, including hygroscopic moisture, the bitumen still in suspension in the emulsion and water in the bitumen emulsion. For example, if 80 litres of bitumen emulsion diluted to a residual bitumen content of 30% is introduced into one cubic metre of material, then the 24 litres of residual bitumen in suspension forms part of the fluid content. However, as it breaks and comes out of suspension, the fluid content reduces by about 1.1% (assuming the material density to be 2 100 kg/m³). The actual moisture content of the material is then 1.1% less than the fluid content.

The fluid content should not be so high as to result in deformation of the surface under final compaction. To make allowance for the type of compaction equipment being used, the optimum fluid content determined in the laboratory is generally reduced on site, based on observations.

When the material being treated is porous, it should be pretreated with water before adding and mixing the diluted bitumen emulsion. Dry material will tend to “suck” the water out of the emulsion, inviting a premature break.

Where the existing asphalt surfacing is recycled with the underlying gravel layer using conventional construction, the asphalt is often first milled and left in a windrow on top of the gravel base. Once the asphalt has been milled, the base layer can then be milled or ripped and broken up. After mixing and blending the milled material with the existing gravel base material, the active filler is mixed in immediately ahead of the introduction of the bitumen emulsion, always as a continuous operation.

6.3.4 Compaction, Cutting Levels and Finishing

The procedures described under Section 6.2 for in situ treatment using recyclers are essentially the same as those to be followed when working with conventional equipment.

It must always be borne in mind that, when processing BSMs, the material behaves similarly to an ordinary granular material, such as a G2 crushed stone or G5 gravel, depending on the type of material treated. Once mixed, the BSM should be processed in exactly the same way as an untreated material. The operations involved in placing, compacting, cutting levels and finishing required to achieve a new pavement layer are the same, with or without the addition of a bitumen emulsion.

The only differences are:

- Neat water must never be applied to the material once diluted bitumen emulsion has been added.
- Ten per cent (10%) of the bitumen emulsion should be held back for enrichment of the upper 10 to 15 mm of the layer during the finishing (slushing) process.

A problem that sometime arises is roller “pick-up” during the final finishing process caused by the emulsion breaking. Although not recommended, where the road needs to be opened to traffic, this can be overcome by blading a thin layer of fine, dry material, for example, sand, across the surface to allow the rollers to complete their work before opening the road.

6.4 IN PLANT TREATMENT

In plant mixing is normally used on projects where:

- **A consistent superior quality BSM** is required for asphalt base replacement. This is achieved by stockpiling the input materials, such as graded crushed stone and/or processed RA, prior to blending and mixing. Pre-stockpiling allows the materials to be tested prior to mixing to ensure that they meet the standards required.
- **All input aggregates are available at one location.** Mixing at source reduces the transport demand and eliminates double-handling.

- After treatment, the mixed BSM product needs to be **stockpiled for later use**. This is an important requirement on some projects, especially those using labour intensive methods for layer construction.
- The BSM needs to be **placed by paver** to meet stringent shape and level tolerances for the completed layer. This situation arises where the BSM is used as the main structural base on a Category A road with a thin surfacing.

The ability to control the quality and blend proportions of input materials increases the degree of confidence that the mixed product meets performance expectations. In addition, the application rate of bitumen stabilising agent and active filler can be minimised with confidence knowing that the material to be mixed will be similar to that used in the mix design.

6.4.1 Mixing Plant

The plant used to produce a BSM must be capable of accurately blending predetermined proportions of different input materials whilst simultaneously adding the correct amount of bitumen stabilising agent, water and active filler to consistently produce a homogenous product.

Treating with foamed bitumen. Since foamed bitumen has to be applied and mixed with the material as soon as it is produced, a sophisticated mixing plant is required. Figure 6.8 shows the layout of a typical plant used for treating selected material with foamed bitumen.

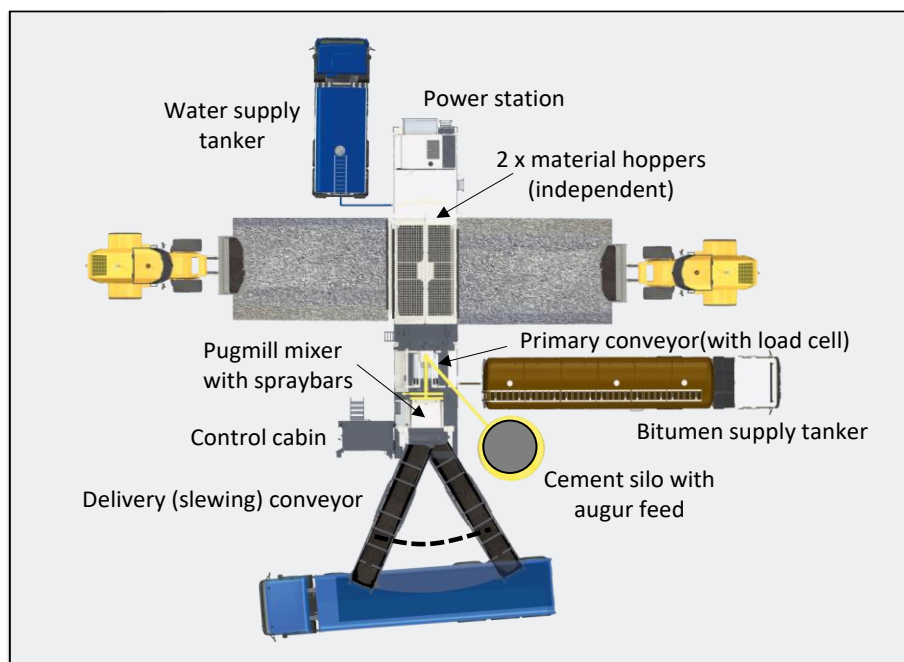

Figure 6.8 Mixing Plant for Treating Material with Foamed Bitumen

The primary features of such a plant are:

- Diesel engine to provide the power required for both hydraulic and electrical functions. This allows the plant to operate independently in remote areas.
- Separate material hoppers that allow two different materials to be accurately blended, such as graded crushed stone and processed RA.
- An integrated water tank with sufficient capacity to allow the plant to continue to operate whilst changing supply tankers.
- Micro-processor controlled with primary input from a heavy-duty load cell positioned beneath the primary conveyor.

- Large twin-shaft pugmill mixer with sufficient power to mix the material at a throughput that allows economic production (± 200 tons per hour).
- Method for the precise metering of active filler (cement or hydrated lime) at a low application rate $\leq 1\%$ by mass.
- Foamed bitumen application system that meets the same basic requirements as those listed in Section 6.2.1.4 ii for systems mounted on recyclers. In addition, the system must be capable of maintaining adequate bitumen feed pressure to the expansion chambers, regardless of the production rate.
- Separate water application system that allows the application rate to be instantly adjusted independent of the other application systems.
- A delivery conveyor for loading trucks directly from the belt. The conveyor should be capable of slewing sufficiently to allow a reasonable quantity of material to be temporarily stockpiled beneath the belt for at least one hour's production.

Treating with bitumen emulsion. A relatively unsophisticated mixer can be used for producing a satisfactory BSM-emulsion. On smaller projects, a concrete mixer is often used with volume batching. Provided the constituent materials are correctly proportioned in the mixer and the retention time is sufficient, an acceptable product will normally be obtained.

6.4.2 Input Materials

i. Material to be treated (aggregates)

Materials for mixing are stockpiled adjacent to the plant on properly prepared bases. Stockpiles of different material must be sufficiently far apart to prevent the material from one stockpile contaminating the material in a neighbouring stockpile. It must be appreciated that materials lying in stockpiles are susceptible to changing weather conditions, more so than in situ material protected within a pavement. In plant mixing, therefore, requires additional care to monitor the condition of all stockpiled material.

The temperature limitations prescribed in Chapter 4 for producing BSMs must be strictly followed. Wind chill often plays a significant role in reducing the temperature of moist material exposed to the elements. When working with moist material in windy conditions at an ambient temperature approaching the lower limit, it is advisable to check the temperature of the material as it enters the mixer. If the measured temperature falls below the prescribed limit, mixing must stop.

Where two different materials are to be blended in the mix, each is loaded separately into one of the two hoppers on the plant. The exit gates feeding the material onto the primary conveyor are then adjusted in accordance with the required proportioning. Such settings are critical and the relevant instructions / guidelines from the manufacturer of the plant must be carefully followed.

Where three or more different materials are blended in the mix, a separate series of bins must be established with a conveyor feeding the required blend to the hoppers on the plant. Cold-feed bins normally used to feed hot mix asphalt plants are ideal.

ii. Bitumen stabilising agent

When a specific mixing site is to be occupied for an extended period, static storage tanks for the bitumen stabilising agent are normally established next to the plant, thereby separating the logistics of supply from production. Such tanks must have a heating facility and be fitted with a pump to circulate the contents. In addition, each tank must have a calibrated dipstick to allow the contents to be accurately measured.

Alternatively, when the quantity to be mixed is limited and the plant will move after a short stay, bulk haulage tankers are used to supply the plant directly. Such an arrangement is not ideal. In addition to demurrage charges, the contents of the tanker may not be entirely consumed in a single shift.

This introduces two additional concerns:

- Heating the bitumen or bitumen emulsion to the required temperature before production can resume. This can be a problem if the level of bitumen (or emulsion) in the tanker falls below the heating flues.
- Reconciling the application rate for the mix produced during the shift as this is normally a payment item. The tanker must then be weighed to determine the tonnage remaining. Alternatively a calibrated dipstick can be used, provided the tanker is correctly positioned so that reliable dipstick reading can be taken.

Since the cost of the bitumen stabilising agent component dominates the unit cost of producing a BSM, it is essential that a reliable system is established to monitor and control consumption.

iii. Active filler

The quantity of active filler applied is relatively small, $\leq 1\%$ by mass, requiring some 2 tons of cement or lime per hour to be added when the plant throughput is 200 tons per hour. This translates to 40 x 50 kg pockets of cement or 80 x 25 kg bags of lime. Such low quantities are normally fed into the active filler receiving hopper by hand. Alternatively, when the plant is to remain in one location for an extended period, a silo can be erected over the receiving hopper.

iv. Water

The water required for increasing the moisture content of the material is normally supplied from a tanker connected to the plant. Where foamed bitumen is applied, the on-board water tank is used exclusively for storing and supplying potable water to the expansion chambers.

6.4.3 Mixing

The mixing plant must be set up and operated in strict accordance with the manufacturer's guidelines. Particular attention must be paid to ensuring that the main chassis of the machine is both secure and level since this affects the operation of the load cell.

Material for mixing is fed into the hoppers on the plant using a front-end loader. Where two materials are to be blended, each is loaded into a separate hopper and the feed gates set to provide the required blend on the primary conveyor.

The application requirements are entered into the plant's computer, for example, 1% active filler, 2.1% foamed bitumen and 1% water. When the plant is started, material is drawn from the hoppers by the primary conveyor that passes over the load cell en route to the mixer. The load cell provides the computer with the information required for controlling the application systems. Flow meters are used to verify the quantities pumped to the spray bars at the mouth of the mixer whilst a separate load cell measures the mass of active filler being applied.

The input materials all combine at the mouth of the twin-shaft pugmill mixer where they are blended by the rotating mixing blades. The pre-set angle of the mixing blades moves the material towards the opposite end where it falls onto the delivery belt through a door in the bottom of the mixer.

The moisture content of the material in the mixer is of primary importance and must, therefore, be continuously monitored. As explained in Section 6.2.2.2 vii, material that is too wet (over OMC) or too dry ($< 50\%$ of OMC) will not produce a satisfactory product. When working during periods of unstable or wet weather, covering the stockpiles of input material will assist in maintaining a constant moisture content.

The mixed material is normally trucked directly to site and used immediately to construct a new pavement layer. Alternatively, the treated material can be stored in a stockpile at a strategic location for later use.

6.4.4 Stockpiling the Mixed Material

In addition to the stockpiling requirements described above for input materials, the normal requirements concerning material placed in stockpiles must be addressed. These requirements include the avoidance of contamination by preparing a competent platform beneath the stockpile and preventing material segregation.

BSM-Emulsion

Stockpiling material treated with bitumen emulsion is generally not recommended due to the potential for the emulsion to gravitate (drain) from the aggregate.

BSM-Foam

These materials may be held in stockpile for several days, provided:

- The stockpile is built with no compaction applied to the material.
- The moisture content is maintained at approximately the OMC of the material.
- The entire stockpile is covered (sealed) with an impervious blanket (tarpaulin) to shield the material from sunlight.
- Hydrated lime is used as the active filler, not cement.

6.4.5 Transporting BSM

Material segregation is a primary concern, especially where the material is relatively coarse. Where such segregation cannot be adequately controlled when loading trucks directly from the delivery conveyor on the plant, the material should be transferred to a temporary stockpile. Normal loading procedures should then be followed when extracting material from such a temporary stockpile. Note that the temporary stockpile must contain sufficient material to allow such loading procedures to be followed.

Where BSMs are transported over long distances, moisture loss must be minimised by covering the treated material with an impervious heavy duty sheet (tarpaulin).

6.4.6 Layer Construction Using a Paver / Finisher

The type of paver and screed, the condition of the equipment and the expertise of those operating the equipment are critical factors that dictate the quality of product achievable when paving a layer of BSM. Unlike asphalt, a BSM is not a cohesive material and it is paved at ambient temperatures. Paver set up and operating procedures are, therefore, different.

6.4.6.1 Paver and Screed

The thickness of the layer constructed and the paving width dictate the volume of BSM that the paver must handle. A 150 mm thick layer paved over a 5 m half-width requires 0.75 m³ (about 1.6 tons) of compacted BSM per linear metre. To achieve a consistent mat, a heavy-duty tracked paver is normally required to handle such a material volume and simultaneously push the delivery truck.

Provided the paver is capable of managing the amount of material, it is the screed attached to the paver that largely determines the quality of the paved mat and the final product. A thick layer of relatively low-cohesion material requires a screed that is sufficiently light to “float” on the spread material whilst simultaneously imparting sufficient pre-compaction energy to achieve a uniform level of density across the paved width. Utilising the correct screed is, therefore, critical.

Screeds with hydraulically-adjustable width capabilities are generally heavy and, because they are in three separate sections, are difficult to set up to eliminate steps forming between the sections. To achieve a float with such a screed normally requires the use of a “screed assist” function which, in turn, requires a relatively high level of expertise to pave a BSM. Single unit screeds with bolt-on extension boxes for obtaining the required paving width are, therefore, preferred. To mould the material and minimise lateral movement, both ends of the screed should be fitted with 45° bevelled end plates.

In addition to placing the material to the required line and level, the screed must uniformly pre-compact the material to the highest achievable level of density. The higher the density obtained by the screed, the less the rolling required to achieve the target density and the lower the risk of rolling the mat out of shape. Screeds equipped with high-amplitude tamper bars have been shown to be the most successful for paving BSMs.

6.4.6.2 Compaction Equipment

Unlike in situ treated BSMs where layer thicknesses in excess of 200 mm are the norm, paved layers of BSM seldom exceed 150 mm in thickness. Such a layer thickness can be compacted using a vibrating roller with a static mass of between 10 and 12 tons. Tandem smooth-drum vibrating rollers are normally used on paved material since the material encountered behind the paving screen is denser than the loose material that is typical behind in situ recyclers. In addition, tandem rollers do not disturb the surface of the mat as do the rear wheels of single drum rollers.

6.4.6.3 Limitations of Paving Thick Layers

It is always preferable to construct a pavement layer as a single monolithic unit. Separating the layer into two thinner sub-layers introduces a horizontal construction joint that can become a weak horizon.

Although it is possible to pave a thick (> 200 mm) layer of BSM, the consequence is invariably a loss of shape when using rollers to apply the high amplitude vibrating energy required to achieve density in such a thick layer. Since the amount of compaction energy exerted by the screed is constant, increasing the thickness of material paved reduces the density that can be achieved by the screed.

Paving a thick (> 200 mm) layer as two thinner layers is not recommended. In theory, it should be possible to achieve an integral bond between the two layers but the realities of a construction site make it all but impossible to guarantee that such a bond is achieved over the full length and width of the road.

Should a situation arise where two layers must be constructed on top of one another, only BSM-foam can be considered. This is because bonding between the two layers is possible if the surface of the first layer is kept continuously wet until the second layer is paved. Such practice precludes BSM-emulsion from being paved in two sub-layers because constant wetting with water washes the bitumen emulsion out of the material. Substituting dilute emulsion for water is not an option because of the risk of creating a film of bitumen on the surface that exacerbates the risk of delamination.

Paving as two thinner layers has been successfully achieved with BSM-foam using the following method:

- Determine the thickness of each of the two layers, keeping in mind that the thickness of each layer must be more than 3 times the maximum particle size. For example, where the maximum particle is 37.5 mm, the layer thickness must be greater than 113 mm. It is advisable to pave a thicker first layer with the second layer kept as thin as is practical, but never less than 100 mm. For example, where a 250 mm thick layer is required and the maximum particle size is 25 mm, the first layer should be paved 150 mm thick and the second layer 100 mm.
- Pave the lower layer on the first half-width for a maximum distance of 200 m. Compact using only a smooth drum roller operating in high amplitude vibration. A PTR must not be used. Prevent the surface from drying out by frequent watering sprayed sideways from a water tanker travelling on the adjacent half-width.
- Reverse the paver over the completed first layer and immediately pave the second lift to achieve the required layer thickness. Compact with the smooth drum roller and finish off with a PTR.
- In addition to keeping the surface of the first paved layer constantly wet, the immediate surrounds must be kept dust free. This requires the surface of the adjacent half-width to be kept moist whilst paving the first half-width. It also implies that no work should be undertaken when there is a risk of wind-blown dust contaminating the wetted surface of the first layer.

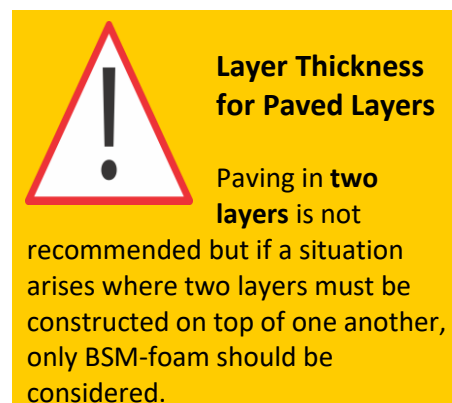

As discussed below, the paved edge that coincides with the centre-line joint requires constant protection. Trucks must not be allowed to run over this edge when delivering material to the paver for the second layer. Special entry / exit ramps may need to be constructed (and removed afterwards) to facilitate such material import.

Paving two layers to achieve one thick layer is time consuming and requires constant attention to detail by the construction team. There is always a risk that the two layers will not bond properly and premature failures may arise due to delamination and shearing. When faced with having to construct a thick layer of BSM, serious consideration should be given to placing by grader as a single layer (as described in Section 6.4.7).

6.4.6.4 Construction Requirements

The following aspects are critical when placing BSMs by paver:

i. Paver Set Up

Setting up the paver and screed are fundamental requirements on any paving job. However, setting up the paver to work with BSMs requires an understanding of material behaviour, especially how the particular BSM will flow and bulk. These material characteristics are influenced primarily by the grading and angularity of the aggregate in the mix, as well as the moisture content. They dictate what adjustments need to be made to the screed so that it achieves the consistent “float” that is imperative to obtain a smooth mat. Where the screed is not set up properly, it tends to sink into the mat and create undulations.

Trial sections for paved BSMs should be constructed off site where the consequences of varying the screed settings will not affect the permanent work. The construction of Trial Sections is discussed in Section 6.7 below.

ii. Paving the Layer

The same fundamental procedures for paving hot mixed asphalt are applicable to paving a BSM:

- **Continuity of paving.** Sufficient trucks should be provided to ensure a continuous supply of material to the paver. Irregularities (bumps) in the mat are normally created by the screed settling in to the paved material when the paver stops. The biggest steps in the mat, however, are caused by delivery trucks reversing into the paver, forcing the screed backwards into the paved material. Trucks should always stop immediately ahead of the paver, allowing the paver to advance and gently engage.
- **In rolling terrain,** the paver should always advance uphill pushing the delivery truck. Such practice facilitates material feed from the truck to the augers feeding the screed and maintains pressure on the screed. Paving downhill runs the risk of material starvation as the paver tends to pull away from the material under the screed.

Similar to paving a G2 type of graded crushed stone material, material segregation is always a concern when paving a BSM, especially where the material is relatively coarse. Segregation can be minimised by:

- Maintaining the moisture content of the material above 50% of OMC. Material that has been allowed to dry out (normally due to standing for prolonged periods un-sheeted in the truck) segregates far more than moist material. Such material should be rejected.
- Sacrificing the material in the wings of the paver’s receiving hopper. The receiving hopper should be filled with material from the first truck-load of the day and never tilted until the end of the working shift when it is discarded.

i Segregation

To avoid segregation while paving:

- The moisture should be > **50% of OMC.**
- The material in the **wings of the receiving hopper** must be discarded.

The surface of the layer on which the new layer of BSM will be paved must be clean and free of all loose material and foreign matter. Immediately prior to paving, the surface must be thoroughly moistened by spraying with water. Any water ponding must be removed by brooming before the BSM is paved. Additional watering is required if the surface dries out.

Paving is normally undertaken in half-widths. A good joint on the centre-line is best achieved by constructing both halves during the same working shift. This means that the initial half-width is first paved over the full length of road to be paved, compacted and finished off, usually with a fog spray and light application of crusher dust to facilitate early trafficking. The second half-width is then paved and finished off before the end of the shift.

iii. Construction joints

Longitudinal joints are inevitable since few roads are paved full-width in one operation. As described in Section 6.2, these joints are zones of potential weakness and should, therefore, be located away from the trafficked wheel paths. On a typical rural road with two lanes, the longitudinal joint will normally be located on the centre-line.

Longitudinal joints generally receive the following treatment when a BSM is paved:

- Once the first half-width is paved, the 500 mm wide section closest to the centre-line receives only one pass with the roller without vibration, leaving it in a relatively uncompacted state, as can be seen in Figure 6.9. All public traffic and construction vehicles must be prevented from running over the step of material thus formed on the centre-line.



Figure 6.9 Uncompacted Strip of Material on the Centre-Line

- Immediately before paving the second half-width, the exposed edge on the centre-line together with the partially compacted strip is thoroughly moistened. This is normally undertaken by a separate team equipped with hand sprayers walking ahead of the paver.
- Prior to paving the second half-width, the bevelled end plate is removed from the centre-line end of the screed. This allows the screed to butt up against the exposed step of the first half-width, as illustrated in Figure 6.10.



Figure 6.10 Paving the Second Half-Width

The partially compacted strip of material remaining on the first half-width then receives the full compaction and finishing treatment together with the second half-width.

Lateral joints occur at every location where paving stops and a ramp must be constructed to accommodate the traffic. The following day, or when paving restarts, the material in the ramp must be removed and the previously paved BSM material cut back to achieve a 45° slope and a consistent level profile. The material lying on the slope is then thoroughly moistened before paving continues.

iv. Compacting the Paved BSM

The primary concern when using the heavy vibrating rollers required to compact a paved layer of BSM is loss of shape. The rolling pattern established whilst constructing a Trial Section (see Section 6.7) must be strictly followed, especially when making the initial pass that creates the outside edge restraint.

As described above, tandem smooth drum rollers are always used to compact the BSM behind the paver. Equipped with two vibrating (and/or oscillating) drums, these rollers normally achieve the required density with relatively few passes. However, operators need training to prevent over-rolling and shape loss since the technique required to compact a BSM is very different from compacting hot mixed asphalt.

Once the required density has been achieved, the layer is finished off using a PTR. The procedure is the same as described in Section 6.2 for in situ treated layers of BSM.

6.4.7 Layer Construction Using Conventional Construction Equipment

Conventional equipment is normally used in preference to paving where in plant mixed material is used to construct layers of BSM that are more than 200 mm thick. However, there are two limitations:

- Thick layers demand more material than can be managed when working in half-widths. For this reason, placing a BSM with conventional equipment is normally only applicable to new construction where the full road width is available.
- Working with graders always results in moisture loss since the material has to be spread out over a relatively large area for extended periods of time. This moisture loss needs to be replaced by adding water that makes this method inappropriate for BSM-emulsion.

Essentially, the procedure followed is the same as that described in Section 6.2 for placing in situ treated material with the following differences:

- The surface of the layer on which the new layer of BSM is to be constructed must be cleaned and thoroughly moistened before the treated material is imported and tipped out.
- To limit moisture loss, the grader should start placing as soon as material has been imported over a sufficient length of the road (normally 100 m). The addition of water or diluted bitumen emulsion and the in situ mixing necessary to achieve a uniform moisture content is always required to compensate for the inevitable loss of moisture due to evaporation.

The procedure followed for finishing off the new layer is the same as described in Section 6.2 for in situ treated layers.

6.4.8 Layer Construction Using Labour Intensive Methods

BSMs are popular for road upgrading projects that use labour intensive construction. Most of the labour is used for spreading and placing the BSM prior to compacting with relatively light vibrating rollers. This normally limits the layer thickness to 125 mm.

The process starts by preparing the surface on which the new layer is to be constructed. A grader and heavy vibrating roller is often used for this work since the longevity of the pavement is largely determined by the competence



Labour Intensive Construction

BSMs are appropriate for labour intensive construction, but the thickness of the layers is normally limited to 125 mm.

of the underlying support. Alternatively, where the support is competent, the existing road surface can be trimmed by hand and swept clean.

Once a firm surface has been achieved, side forms are erected to contain the imported BSM. Since these side forms dictate the line and level of the new BSM layer, they need to be made out of heavy duty material with a truly straight top edge. Steel shutters that are commonly used for structural work are often employed. Such side forms are positioned with the top edge set at the correct elevation by placing or excavating material beneath the bottom edge. Side forms need to be firmly anchored in place using a series of suitable steel stakes.

BSM-Emulsion

Mixing is usually undertaken on site using a concrete mixer. Input materials are volume batched and the mixed product taken straight to the road in wheelbarrows. Two mixers are often used to increase the production rate and maintain a consistent flow of treated material.

BSM-Foam

Due primarily to its ability to be held in stockpile for extended periods, BSM-foam is ideal for constructing a new pavement layer using labour. Stockpiles should be kept covered until the material is required and then thoroughly wetted before extracting the material. The mixing plant for this type of work is normally located at a central location and the material trucked to site, stockpiled and covered for later use.

BSM is imported by wheelbarrow and tipped between the side forms. This material is then raked into place and struck off flush with the top of the side forms. It is important that a reasonably uniform density is achieved in the material that is loosely spread between the side forms. Material lying in the mound created by tipping from a barrow is partially compacted by the tipping action, whereas material spread by hand is completely loose. Care must, therefore, be taken to rake all the material away from the location where it was tipped. Failure to follow this simple requirement inevitably results in a poor surface shape after the material has been compacted.

As soon as the material has been spread and struck off, the surface is thoroughly moistened (using water with BSM-foam and diluted bitumen emulsion with BSM-emulsion) before the roller starts work. The surface must be kept moist during the entire compaction process. Walk-behind “pedestrian” rollers with a static mass of between 1 and 2 tons (commonly used for trench backfilling) are normally employed. To assist the operator to achieve the same compaction effort over the entire area, stakes are often positioned across the road at the same interval as the width of the drum to act as a guide. The same number of roller passes is then undertaken on each strip, with the drum overlapping the previous strip by 50%.

The strip of material immediately against the side forms normally receives an additional two roller passes with care being taken not to disturb the shutter. Once a section has been compacted, the side forms can be removed and a small plate compactor employed to compact the exposed edge.

Finishing is usually carried out using a second pedestrian roller together with additional moisture to achieve a mild slush.

Although labour intensive construction may be deemed to be beneficial for socio-political reasons, the physical limitations of the process dictate where it can be used. Layer thicknesses in excess of 125 mm cannot be properly compacted using the type of rollers that are used. This is a major limiting factor. Moisture loss due to the slow rate of progress is also a concern. Other limitations include the production rate achievable, the space required for working with side forms and the conflict of labour and traffic where construction in half-widths is contemplated. For these reasons, this method of construction is normally restricted to projects concerned with upgrading low-volume roads.

6.5 CURING AND TRAFFICKING

One of the main benefits of using BSMs on rehabilitation projects is the ability of these materials to withstand traffic loading soon after the layer has been completed. This feature eliminates the need for extensive traffic

Spreading the mix

A reasonably uniform density must be achieved in the material that is loosely spread between the side forms. This requires raking of areas that are partially compacted by the wheel barrow and tipping action.

diversions or detours. Rehabilitation work is normally undertaken by recycling the road in half-widths with unidirectional traffic accommodated by means of stop/go controls on the adjacent half. Outside construction hours the full road width is open to traffic.

BSM-Emulsion

On compaction, the increase in density is not sufficient to ensure resistance to traffic damage. An increase in cohesion is required for resistance to traffic damage, which is dictated by the time required for the bitumen emulsion to break out of suspension. This normally takes a few hours at the surface where evaporation triggers the break, but can take several days for the bitumen emulsion deeper in the layer

BSM-Foam

On compaction, the instant increase in cohesion makes layers of BSM-foam resistant to traffic damage. However, they remain “tender” until the moisture content reduces.

The resistance to traffic damage can be monitored by parking a heavily loaded vehicle, for example, a full water cart, on the new layer. After a relatively short period (< 1 hour), the wheels will settle into the material, leaving localised indentations that can be as deep as 10 mm. As the material dries back, this propensity to deform reduces until, after a day or two of warm weather, it ceases altogether. This phenomenon needs to be taken into account when planning road closures. Stop/go controls should be positioned such that the daily traffic is only allowed to stand where the layer of BSM was completed at least 24 hours previously.

Allowing traffic to travel on BSM layers has the benefit of showing up construction defects. Sections with an under-application of bitumen tend to ravel excessively when exposed to traffic loads, drawing attention to any area that requires remedial measures to be taken before the final surfacing is applied. However, the surface should be kept clean of loose material to prevent ravelling and it is recommended that a fog spray of diluted emulsion is applied within 24 hours of completing the new layer.

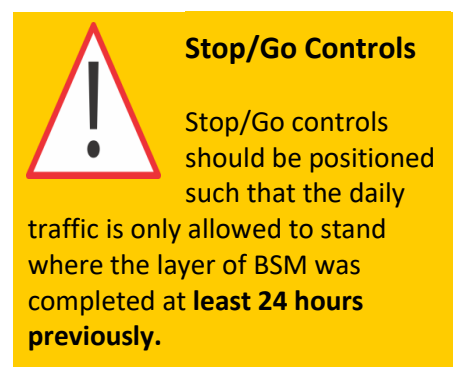

6.6 SURFACING

The dispersed nature of the bitumen is responsible for increasing the cohesion that gives BSMs sufficient early strength to withstand traffic loads. Since the particles at the surface are only held in place by small spot welds along their lower faces, dynamic forces imparted by heavy tyre loads tend to loosen and remove the coarser particles at the surface, causing roughness as a consequence of ravelling.

Whilst some remarkable successes have been achieved in protecting the surface from such damage by using a dilute bitumen emulsion in the slushing process and/or the application of a light fog spray, it is recommended that the surfacing is applied as soon as possible to provide protection against both water ingress and excessive traffic abrasion. However, the surfacing must not be placed before the moisture content in the new BSM layer has reduced sufficiently to resist chip punching (where a chip seal is applied) or resist compaction forces where an asphalt is paved.

The dilemma is to know when the moisture content has reduced sufficiently. Moisture loss is largely dictated by the climatic region and prevailing weather conditions. Where a BSM is constructed during late spring / early summer in a region with a high Weinert N value (where daytime temperatures exceed 35°C with no rainfall), the rate of moisture loss will be rapid and the delay before surfacing will be a short (3 to 5 days). However, on the east coast where the humidity is high and rainfall occurs every month of the year (corresponding to a low Weinert N value), the reduction in moisture content will take much longer, up to two weeks without rain.

Adopting the COTO specification for a G1 base (which stipulates that the moisture content must be below 50% of OMC) should not be applied to BSM base layers for two reasons:

- i. The OMC of a recycled BSM can vary by 2% or more, dictated by the properties of the recovered material. To apply this, 50% of OMC requirement necessitates determining a relevant OMC value by carrying out a moisture/density relationship test every time the moisture content is measured; and
- ii. The moisture content will often not reduce to below 50% of OMC in a BSM, especially in humid regions.

It therefore makes no sense to specify a moisture content requirement relative to the OMC.

The best indicator of the moisture content in a BSM layer is stability. The layer should be “proof rolled” with a heavy pneumatic tyred roller (or fully-loaded water tanker) to determine whether or not the layer deforms (heaves) under such a load. If no deflection is observed then the moisture content has reduced sufficiently to safely pave and compact an asphalt wearing course. If, however, movement is detected, the moisture content is still too high and the asphalt surfacing should be delayed to allow the moisture content to reduce further.

When a chip seal surface treatment is to be applied on a new BSM layer, the “hardness” of the layer is the key to when the surfacing can be applied. This is best determined by carrying out a series of ball penetration tests. The test should be repeated on a daily basis until the results are constant, indicating the amount of chip punching that will take place under traffic loads. This “embedment” value is then used in the seal design to determine an appropriate spray rate for the bitumen.

Prior to applying a surfacing layer (asphalt or chip seal), the surface needs to be thoroughly cleaned to expose the texture of the material aggregates. A prime coat should not be applied on BSM bases because the dispersed bitumen present at the surface of the cleaned layer provides adequate adhesion for a bituminous surfacing layer. Experience has shown that where an emulsion prime is applied, it tends to form a skin on the surface. With time, this film of bitumen migrates upwards into the surfacing material, resulting in fattiness or bleeding.

Note: A cutback prime should never be applied to a BSM base because the lighter fractions in the cutback (the volatiles) will attack and dissolve the dispersed bitumen bonds in the upper part of the layer where applied stresses are the highest.

6.7 CONSTRUCTING TRIAL SECTIONS

A Trial Section should always be undertaken at the start of a new project (or when warranted by changes on site) to determine the correct settings for the equipment and subsequent treatment of the material. Prior to commencing the Trial Section, the contractor must prepare a detailed proposal describing the various procedures that will be undertaken in order to produce the required end product.

6.7.1 Trial Sections for In Situ Treatment

As a minimum, the following details should be included in the Trial Section proposal:

- **A schedule of the plant and equipment** that will be used for the work. This schedule must include all items that will be used for the permanent work.
- **A detailed cut plan** showing the width to be recycled together with all overlap details.
- **The maximum dry density (MDD)** that governs the application rates for the bitumen stabilising agent and active filler, together with laboratory tests to verify this data.
- **Roller details** (static mass and drum type), the anticipated number of passes to be made by each roller, the rolling pattern and method to be employed to determine when sufficient compaction effort has been applied.
- **Sampling** frequency and tests to be conducted.

Trial Sections must always be located so as to be truly representative of the recycling work, and, where possible, representative of the underlying pavement support characteristics.

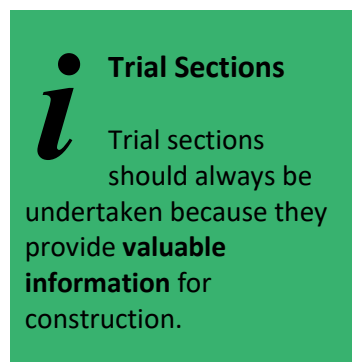

While the Trial Section is being executed, the following details need to be monitored:

- **Grading of the recycled material.** The forward speed of the recycler, the rate of rotation of the milling drum and positioning of the breaker-bar should be varied to determine which combination produces the best result in terms of pulverisation and smoothness of the resulting grading curve.
- **Moisture addition.** Determination of the optimum mixing moisture content (the “fluff point”) and the amount of water that needs to be added through the dedicated water spraybar to achieve the required moisture content.
- **Mixing quality.** Experience has shown that advance speeds in excess of 10 m/min are detrimental to mixing quality. In addition, the pressure exerted on the rear door of the mixing chamber can be varied, thereby changing the degree of “choking” (the amount of material retained in the mixing chamber). As well as improving the quality of the mix, these settings affect the grading of the product, particularly the coarser fraction. To check the quality of the mix, small inspection holes should be opened through the full thickness of recycled material at regular intervals immediately behind the recycler. Differences between the top and bottom horizons of the recycled material should be noted, especially any significant differences in grading. Numerous large chunks of asphalt at the bottom of the layer indicates the need for pretreatment (see Section 6.2.1.3. iv.). However, if the material being recycled is very coarse or gap-graded, the lower horizon will be dominated by the larger fractions (the “bones”) whereas the upper portion will appear normal. This indicates the need for blending with a relatively fine material (e.g. crusher dust) that can be spread on the road surface before recycling (see Section 6.2.2.1. iv.).
- **Bulking.** Bulking of the recycled material, the size of the working windrow and the amount of material to be removed after completion.
- **Compaction requirements.** Adequacy of the roller for achieving density and the number of passes required is normally monitored by the rate of densification. If the primary roller is not equipped with an intelligent compaction system, a nuclear gauge can be used to determine the density of the layer and the change in density with each pass can be recorded.
- **Detailed records.** A record of the precise sequence of events and the relevant timings should be taken for future scheduling purposes.

Invaluable information is obtained from Trial Sections. They should always be properly planned and monitored. The area to be recycled as a Trial Section should be determined by one tanker-load of the bitumen stabilising agent. A full working day should be set aside to conduct the necessary surveys and tests without production pressures.

6.7.2 Trial Sections for In Plant Treatment

Where the BSM is paver laid, the location selected for constructing the Trial Section should be a side road away from the permanent work. Paver set up is a process of trial and error, invariably resulting in the initial work being out of shape with many undulations. It is recommended that assistance is sought from a specialist with experience in paving of BSMs in order to achieve the desired riding quality.

Trial Sections also provide an opportunity to determine an appropriate rolling pattern as well as the number of roller-passes required to achieve the target density.

Trial Sections for paving applications are seldom finite in length. The objective is to fine-tune the paver and screed until the correct settings for the particular BSM have been established. The requirements for compaction are equally important since a perfectly paved BSM layer can be rolled out of shape by applying an inappropriate rolling pattern. The length of section paved is, therefore, dependent on how long it takes to find the settings that work.

Representative Trial Sections

Trial sections should be representative of the recycling work and the pavement support.

APPENDIX A: DESIGN EQUIVALENT MATERIAL CLASSIFICATION SYSTEM

A.1	INTRODUCTION	104
A.2	CONCEPT	104
A.3	MATERIAL CLASSIFICATION SYSTEM	108
A.4	TESTS AND INTERPRETATION OF RESULTS.....	112
A.5	CONFIDENCE ASSOCIATED WITH ASSESSMENT AND RECOMMENDED APPLICATION	123
A.6	WORKED EXAMPLE	123
A.7	REFERENCES	127

A.1 INTRODUCTION

The derivation of the material classes for each pavement layer is a critical aspect of the design process, since this process effectively determines the structural design inputs. When appropriately done, the classification process also provides a link between the mix design and structural design processes. In this Appendix, the recommended method for classifying materials is presented. The object of the method is to provide a reliable, rational and consistent indication of the appropriate material class. The method is based on the use of all available information and uses fuzzy logic and certainty theory to assess the certainty that materials belong to a particular class. The material class is known as the Design Equivalent Material Class (DEMAC) and, therefore, the method is termed the DEMAC Material Classification System.

The sections below describe the method in more detail and provide all relevant details for the implementation of the method. The details presented in this Appendix are a revised version, termed DEMAC 2020 and replaces the version published in TG2 (2009). The original version is detailed in Jooste et al (2007). The approach can be used in any pavement design context with all common material types and is especially relevant for rehabilitation design.

A.2 CONCEPT

During a routine pavement rehabilitation investigation, an engineer is typically faced with a wide array of test parameters and condition indicators. These parameters can be quantitative or qualitative, subjectively or objectively determined, and the sample sizes for different indicator types may vary significantly. For example, for a specific pavement layer within a uniform design section, an engineer may typically be faced with the following information:

- Seven Dynamic Cone Penetrometer (DCP) tests.
- Fifty Falling Weight Deflectometer (FWD) deflections.
- Two sets of material descriptions and samples from test pits, together with standard materials test results, including Plasticity Index (PI), grading, California Bearing Ratio (CBR), moisture content and density.
- One subjective visual assessment with a description of observed distresses.
- Fifty semi-subjectively determined backcalculated stiffnesses from FWD tests.
- General description of the material type from historical records.
- General description of the history and past performance of the pavement.

From such information, the engineer has to derive the key assumptions needed for the rehabilitation design. The synthesis of the information to arrive at design assumptions is one of the most important, but difficult parts of the rehabilitation design process. Apart from basic analytical skill, it also requires considerable experience and knowledge of the main drivers of material behaviour. When incorrectly done, inconsistent conclusions can be drawn and the design assumptions will not be consistently supported by available evidence.

The concept behind the material classification method is, therefore, to guide engineers in the interpretation of available pavement condition data, and to synthesize available information so that key design assumptions can be derived in a consistent and rational manner. The objective of the materials classification method is, therefore, to provide a method for the consistent assessment of pavement materials using routine tests and indicators.

Many material classification methods are specification type approaches that rely on pass or fail type criteria. For these types of approaches, if any one test fails the criteria for the material class then the material cannot be classified as that class. For example, if the CBR value is below the specification for a G6 material, then the material cannot be classified as a G6 even if all other available test results meet the G6 criteria.

The DEMAC approach is a more rational, albeit less exact method, which can handle vagueness in the data. Rather than giving a yes or no answer, the method indicates the conformance to a material class in less restrictive terms. The approach assesses the certainty that the material can be considered as the particular material class and uses Fuzzy Logic to provide this type of assessment.

The evaluation of pavement materials as part of rehabilitation investigations poses several unique challenges. These challenges are related to the realities of pavement investigations and pavement design, which include the following aspects:

- **Many Sources of Uncertainty:** Pavement engineering deals with large quantities. i.e., long distances, of natural and thus highly variable materials, which are subject to highly variable loads.
- **Risk is Poorly Defined:** The risk associated with pavement failure is poorly defined. For example, what is the consequence of 5% more crocodile cracking over a twelve year period, and is it cost-effective to spend an extra R10 million now to prevent it? Several assumptions are needed to answer this question, and many of these – although they can be estimated – are beyond control, e.g., rainfall, overloading, future budgets, etc. Because of this situation, subjective assessment using experience plays a considerable role in pavement design.
- **Small Sample Sizes:** Reliance on small samples is part of the reality of pavement investigations. It is not unusual for a rehabilitation design over 20 km of road, over varying terrain and geological areas to be based on ten or less trial pits.
- **All Tests are Indicators:** In pavement design situations, the assessment of materials always aims to assess stability and (for some materials) flexibility. It does so either directly (as in a stability test) or indirectly (as in a grading assessment, which impacts on stability). Because the actual load situation varies, no pavement material test is able to completely quantify long term stability or flexibility. Even a highly sophisticated test, like the repeated load triaxial test, must be performed at a fixed moisture content and stress state, which will never correspond completely to the real pavement situation that it aims to assess. Thus, all tests provide only a relative indication of the two key properties to be assessed, and some tests do so very poorly.
- **Interpretation is Vague:** In pavement rehabilitation investigations, an engineer needs to decide what information is available, and what can be done with it. A yes or no interpretation is not always appropriate, and a relative interpretation is needed. This complicates the interpretation of data considerably, especially when conflicting information is involved. It also introduces more subjectivity into the process.

The material classification system deals with these realities. Specifically, the approach incorporates the following elements:

- Clear and rational formulation of the objective.
- Ability to handle vagueness and uncertainty of interpretation.
- Ability to work with small sample sizes.

A.2.1 Assumed Material Behaviour

To provide a sound basis for the materials classification method, a generalised model of pavement material behaviour was adopted. The assumed model is shown in Figure A.1, and represents the material as a conglomerate of coarse particles, fine particles, bitumen and air voids. In the context of BSM, this model applies to composite materials consisting primarily of a combination of loose aggregate and bitumen.

Generally, the model applies to almost all pavement engineering materials except clay, silt and manufactured materials such as geotextiles. The important distinction is that the composition of the mastic differs significantly for different materials.

The behaviour of the material can be described using the well-known Mohr-Coulomb failure criteria where fundamental material properties dictate material strength. The material model shown in Figure A.1 can be used to explain the components that determine the strength and stiffness of the material.

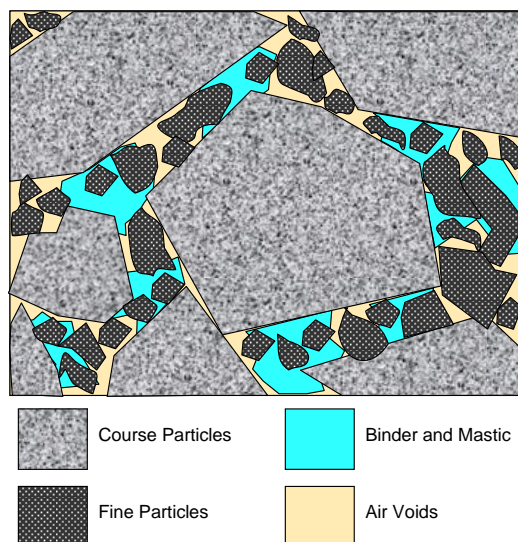

Figure A.1 Generalised Material Model

There are two components that determine the material’s shear strength:

- The cohesive strength, which is determined mainly by the mastic, consisting of the mixed bitumen and fine material.
- The strength provided by inter-particle friction, which is mobilized when compressive stresses force the fine and coarse particles together.

The cohesive and frictional strength components determine not only the shear strength or stability, but also the stiffness and tensile strength. When the material is in compression, the stiffness and shear strength are primarily determined by a combination of the cohesive and frictional elements. When the material works in tension, particles are not pushed together and the stiffness and tensile strength are determined mainly by the cohesive element, i.e., the mastic. Stability and flexibility provide an indication of the resistance to the two main sources of pavement deterioration: deformation (either due to volume change or shear) and cracking (due to fatigue in tension).

The materials that are most resistant to shear and tensile failure are those in which there is a good balance between the strength provided by the cohesive and frictional elements. However, some materials tend to be dominated either by the frictional or cohesive element, as illustrated in Figure A.2.

The relative role that the frictional or cohesive component plays in determining the strength and stiffness depends almost entirely on the state of the mastic. In the case of asphalt, for example, the mastic consists of the bitumen and filler combination. At high temperatures, the viscoelastic bitumen softens. When the material is loaded in this condition, load is transferred directly to the coarse aggregate matrix, and shear strength is almost completely from the frictional component. A similar effect is observed in crushed stone and natural gravels, where excess water destroys the suction forces that bind the fine particles together in a mastic, thereby significantly reducing the cohesive strength or stiffness component.

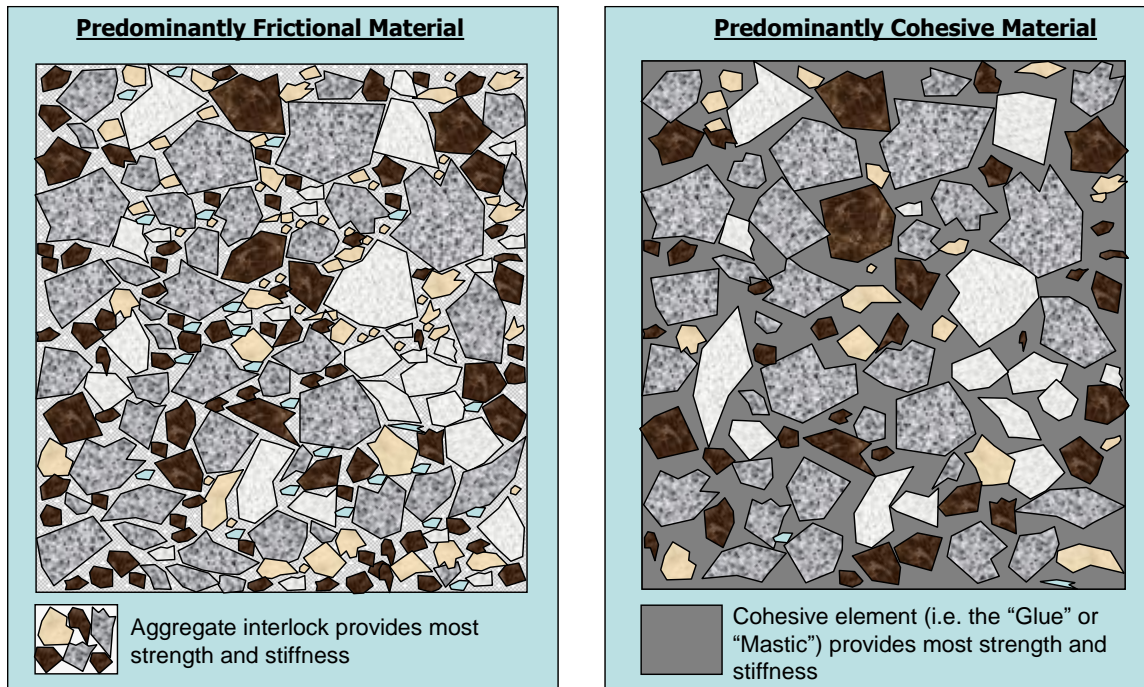

Figure A.2 Material Composition, Showing Dominance of Friction and Cohesion

A clear understanding of the role of cohesion and friction in determining the strength and stiffness of pavement materials is important, as most test indicators provide an assessment of one or both of these elements. Intuitively, a grading analysis and derived parameters strongly relate to the frictional strength component. Some tests like the Plasticity Index (PI), Linear Shrinkage (LS) and the fraction passing the 0.075 mm sieve, relate to the cohesive element under dry conditions and to the friction element under wet conditions. Research also suggests that LS is a better indicator of shear strength than PI (Theyse, 2007). A fundamental understanding of what is measured by a specific test can provide the key to a rational and useful interpretation of the test’s results.

The above definition and discussion of the Mohr-Coulomb model, and the cohesive and frictional components that drive this model, are used in Section A.4 to classify the various materials tests, and to guide their interpretation.

A.2.2 Design Equivalent Material Class

The material classes for granular and cement stabilised materials adopted for this material classification method are aligned with the South African classification systems: G1 to G10, C3 and C4 (TRH14, 1985; COTO Draft Standard, 2019, or the TRH classifications in general). The TRH classification system is regarded as being highly suitable for new construction and rehabilitation design, as the behaviour and performance patterns of each material class is known with some certainty. However, with the material classification method, the obtained material class is regarded as the design equivalent materials class (DEMAC) and will not necessarily fall within the limits for that material class as given in TRH14 or COTO that are based on a traditional one-fail-all-fail system. However, since materials to which design equivalent classes are assigned have been in service for some time, the raw material would conform to (or exceed) the specifications for the class, as defined in TRH or COTO, in almost all situation. Section A.5 considers the potential application of the DEMAC for the classification of new granular materials.

When a design equivalent material class (DEMAC) is assigned to a material, it implies that the material exhibits in situ shear strength, stiffness and flexibility properties similar to those of a newly constructed material of the same class. For example, a layer in an existing pavement structure classified as a G2 design equivalent would indicate that the material is considered to be equivalent to a G2 for design purposes, based on the available test evidence. For brevity, a DEMAC is denoted DE-G2, for example.

The materials classification system described in the next section provides a consistent method to evaluate and document the necessary evidence to support the material classification.

A.3 MATERIAL CLASSIFICATION SYSTEM

A.3.1 Theory of Holistic Approach

The material classification system provides a framework for the rational synthesis of several routine test indicators. The outcome of the assessment becomes more reliable as more test indicators are added to the assessment. This is because each test typically explains only a small part of the cohesive or frictional elements of material behaviour. More complex tests, like triaxial tests, may evaluate these two elements together. However, these tests are also performed at a specific moisture content and are normally not performed as part of routine investigations where each pavement layer is often sampled and tested at a number of locations along the road. Since each test provides only a partial explanation of the material’s behaviour, the reliability of the assessment can be greatly increased by increasing the sample size, and by adding more indicators, i.e., test types, to the assessment. The system is therefore a holistic assessment, which works best when a comprehensive range of test indicators are used.

The theory underlying the method is based on Fuzzy Logic and Certainty Theory. Development of the original method is described in detail by Jooste et al (2007). A summary of the theoretical process to classify a material is as follows:

1. If H is the hypothesis to be tested, then the certainty that the hypothesis is true is designated as C(H), which has a value of 1.0 if H is known to be true, 0.0 if H is unknown and -1.0 if H is known to be false. In the context of the present study, H could, for example, be the hypothesis that the base layer is a DE-G1.
2. The value of C(H) is determined by applying rules which are based on experience or domain knowledge. Each rule has a certainty factor (CF) associated with it, to reflect the level of certainty in the available evidence, or in the knowledge on which the rule is based. A typical rule may be:

If [PI < 4] then [Material is a DE-G1] With Certainty CF

3. The certainty factor of a rule, CF, is modified to reflect the level of certainty in the evidence. This gives the modified certainty factor CF', calculated simply as:

$$CF' = CF \times C(E) \dots\dots\dots(A.1)$$

Where C(E) is a number between 0 and 1, indicating that the evidence in support of the hypothesis is either completely absent (C(E) = 0.0), or known to be present with absolute certainty (C(E) = 1.0).

4. To get C(H|E), which is the updated certainty that the hypothesis H is true, given the evidence E, the following composite function is applied:

If C(H) ≥ 0 and CF' ≥ 0 then: C(H|E) = C(H) + [CF' x (1-C(H))].....(A.2.1)

If C(H) ≤ 0 and CF' ≤ 0 then: C(H|E) = C(H) + [CF' x (1+C(H))](A.2.2)

If C(H) and CF' have opposite signs, then:

$$C(H|E) = \frac{C(H) + CF'}{1 - \min(|C(H)|, |CF'|)} \dots\dots\dots(A.2.3)$$

In the application of the above methodology for material classification, the certainty factor CF associated with a specific test is assigned based on domain knowledge and experience. If the test is known to be a good overall indicator of cohesion, frictional resistance or both, then CF will tend to be higher. The CF is also adjusted based

on the sample size and range of sampled values. For small sample sizes, CF is lowered to reflect decreased confidence in the available evidence.

The steps and equations outlined above provide a general method for consistently evaluating the certainty that a hypothesis is true, given uncertain and vague rules and evidence. A generalized and simplified example of the method's application for materials classification is outlined below:

1. We want to test the hypothesis H that the material for which we have information is a graded natural gravel, DE-G4. To do this, we formulate the following rules:

If [Material is Natural Gravel] and [PI < 4] then [Material is a DE-G4] with CF = 0.3

If [Grading conforms to G4 Envelope] then [Material is a DE-G4] with CF = 0.45

2. We now obtain samples and measure material properties such as the PI and grading. The certainty factors are adjusted based on the sample size.
3. We start with the first available evidence, e.g., PI test. At this stage $C(H) = 0$. Since $CF = 0.3$ for the first rule concerning PI, we use Equation A.2.1 to calculate the updated certainty ($C(H|E)$) for the hypothesis that the material is a DE-G4.
4. The updated certainty $C(H|E)$ becomes the new starting certainty $C(H)$ for the second rule which interprets the grading. We again apply Equation A.2.1 to calculate the new value for $C(H|E)$.

This process can be applied for each material class using all available data to obtain a relative indication of how much the available test data point to each class. The following sections give more details on the process, and a worked example is included in Section A.6.

A.3.2 Step by Step Material Classification

The Certainty Theory approach involves an assessment of how well the available evidence suits a given hypothesis. In the present context, the evidence would be available test data, and the hypothesis to evaluate would be that the material conforms to a specific material class.

The method involves the following steps:

- Step 1.** Decide on the basic materials system to use, i.e. granular or cemented. For the granular system, use the material grading analysis results and visual descriptions to determine the type of material, namely crushed stone (CS), natural gravel (NG), gravel soil (GS) or sand-silt-clay (SSC) type materials. Details related to this step are provided in Section A.3.3.
- Step 2.** For each of the available material tests, determine and report the 90th percentile, median and 10th percentile values from the available observations. For those tests for which a rating system is provided, use the ratings at each observation to determine the required statistics. Where there is only one observation available, simply report the observation as the median value.
- Step 3.** Determine the certainty factor associated with each of the available tests, i.e., CF as defined in Section A.4. This certainty reflects the confidence that we have in each test to provide an accurate indication of the in situ shear strength and stiffness of the material. Details related to this step are provided in Section A.3.4.
- Step 4.** Adjust the relative certainty determined in Step 3 to take account of sample size. This adjustment decreases the confidence for smaller sample sizes. Details related to this step are provided in Section A.3.5.
- Step 5.** Select a likely material class, e.g., DE-G4, for the layer in question.
- Step 6.** For each of the available tests or observations, determine the expected range of values for each DEMAC for the selected material from Tables A.5 and Table A.6 for granular materials or Table A.10 for cemented materials. For example, if the material in question is a DE-G4, and the test is the soaked CBR at 100% of

Maximum Dry Density (Mod. AASHTO), we will use Table A.5 to obtain the expected range of CBR values for a G4 (i.e., 80 to 99%). For tests that involve a rating system, such as grading and consistency, the rating values corresponding to different material classes are shown in the relevant tables in Section A.4.

Some tests or indicators have expected ranges for the material classes for different material types or compaction levels. For example, in Table A.5, the Plasticity Index has different values for crushed stone, natural gravel, gravel soil and sand-silt-clay type materials. In these cases, only one material type or density level may be selected per test or indicator.

- Step 7.** For each test, determine how much the 10th percentile to 90th percentile range overlaps with the expected range of values for the material. This provides the relative certainty that the test data points to the material class in question, i.e., factor C(E) as defined in Section A.3.1. Details of how to perform this calculation are provided in Section A.3.6.
- Step 8.** For each test, use the certainty factor CF from steps 3 and 4 and the certainty of evidence C(E) from Step 7, to update the certainty that the material tested conforms to the class selected in Step 5. This calculation then provides the relative certainty that the material belongs to the selected DEMAC, given the available evidence, i.e., C(H|E) as defined in Section A.3.1. Details on these calculations are provided in Section A.3.7.
- Step 9.** Repeat Steps 5 to 8 for each likely material class. For example, for a granular base assessment, the certainty associated with classes DE-G1 to DE-G5 may be evaluated.
- Step 10** Select the material with the highest certainty given the available evidence. This material class is assigned to the layer in question. Properly document the evidence and calculations.

A.3.3 Material Type

One aspect of the granular rule-based system is the initial and relatively broad assignment of a material type, especially granular materials defined as crushed stone (CS), natural gravel (NG), gravel soil (GS) and sand-silt-clay types (SSC). Although the system makes provision for overlap of classes between material types, this part of the process essentially sorts the material to ensure that “outlier” properties encountered for some material types do not result in unrealistic overall classification of the material. These rules therefore further enhance the experience or knowledge needed for interpretation of the results and help to control variability. Recommended material type selection rules are given in Table A.1, based on the fractions in the gradings. In a uniform section, the material type for the same layer and may vary across test pits – the most representative material type should be selected or a sensitivity analysis considered if the layer exhibits high variability.

Table A.1 Material Type Selection Rules

Fraction Type	Fraction Definition
% Coarse Gravel (CG)	> 20 mm
% Gravel (G)	P20 – 2.00 mm
% Sand (S)	P2.00 – 0.075 mm
% Silt and/or Clay (SC)	< 0.075 mm
Fraction-based Material Type Rule	Outcome
CG+G+S ≥ G+S+SC AND visual/profile confirms crushed stone	Crushed Stone (CS)
CG+G+S ≥ G+S+SC	Natural Gravel (NG)
G+S+SC > CG+G+S AND S+SC < 65%	Gravel Soil (GS)
S+SC ≥ 65%	Sand-Silt-Clay (SSC)

A.3.4 Certainty Factors for Different Tests and Indicators

Because most pavement materials tests provide only a partial indication of the shear strength and stiffness of a material, a certainty factor is assigned to each test indicator. This certainty factor (CF) is introduced in Section A.3.1. From Certainty Theory used in this context, the CF essentially represents the “subjective

confidence” in the ability of a test to serve as an accurate indicator for material strength and stiffness. The value of CF ranges from 0 to 1, with a value of 1 indicating absolute confidence in a test or indicator, a highly unlikely assignment.

Suggested certainty factors for the tests and indicators used in the classification system are provided in Table A.5 and Table A.6 (Granular) and Table A.10 (Cemented). The ratings shown in these tables are based on an assessment of the completeness and appropriateness of each test or indicator. Engineers can adjust these values to take account of experience or specific project situations, but the assumed values should be reported to clients. If the assumed values deviate substantially from those suggested in the tables, the assumed values must be motivated in the assessment report. In this edition, performance datasets comprising routine material test results and triaxial test results done at different moisture levels were used to validate and update the proposed certainty factors (Theyse, 2007 and NCHRP, 2001). This was facilitated using a Bayesian approach to correlation analysis to quantify the amount of evidence in the data.

A.3.5 Adjustment for Sample Size

Small sample sizes, i.e., one or two observations, are not uncommon in pavement condition assessments. However, this affects the certainty with which a material class is assessed. To take account of this, the Certainty Factor (CF) associated with each test is adjusted based on the sample size. Table A.2 shows the recommended adjustment factors based on sample size. These factors are applied by multiplying the factor from Table A.2 with the CF factor for the test from Tables A.5, A.6 and A.10.

Table A.2 Recommended Adjustment of CF Based on Sample Size

Sample Size (number of observations)	Adjustment Factor
1	0.2
2	0.3
3	0.6
4 to 6	0.7
6 or greater	1.0

A.3.6 Assessing the Relative Certainty of Evidence

The material classification method assesses the certainty that a material can be classified as a particular material class. This assessment is vague and uncertain because of the incompleteness of most tests and because a sampling estimate is used. The incompleteness is taken into account with the Certainty Factor (Section A.3.4.), but the variation in the tests results needs to be considered.

The method for accounting for the variability is illustrated in Figure A.3. The figure shows the CBR limits associated with material classes DE-G5, DE-G6 and DE-G7. Also shown is a triangle which is determined as follows: left bottom corner is the 10th percentile value, the apex is the median value and right bottom corner is the 90th percentile value.

The triangle represents the available evidence in a relative manner. The height of the triangle is given a fixed value of 1.0. The total area of the triangle and the portion of the triangle that falls within each DE-class is calculated. The relative area that overlaps with the DE-G6 class gives us a relative indication of how strongly the CBR evidence points to a DE-G6 class. In the context of the certainty theory methodology, it is assumed that the relative area that overlaps with the material class in question, is the factor C(E) as defined in Section A.3.1.

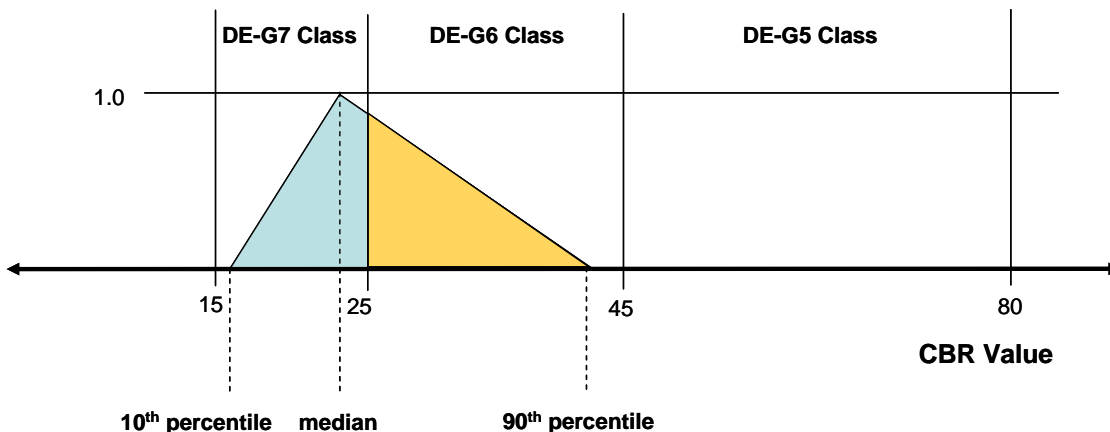

Figure A.3 Determining Relative Conformance of Evidence to Material Class Limits

A.3.7 Updating Material Classification for Available Evidence

The objective of the assessment is to determine the certainty associated with the hypothesis that a material conforms to a selected DEMAC. For example, if the material selected for evaluation is a DE-G6, the relative certainty that the material is indeed a DE-G6 can be calculated. As defined in Section A.3.1, the certainty for this hypothesis is C(H), which is initially zero, but increases tests for which the results conform partly to the range expected for a DE-G6 material are considered.

The certainty factors for the different tests, combined with the adjustment for sample size, provide the certainty factor CF associated with each test (Section A.3.4). The comparison of the test results with the expected limits for the DEMAC in question, (as shown in Figure A.3 and discussed in Section A.3.6), provides the certainty that evidence is present, C(E). These are all the factors needed to calculate an updated certainty for the hypothesis that the material tested conforms to the selected DEMAC, i.e. C(H|E) as defined by Equations A.1 and A.2 (Section A.3.1).

Usually, the calculation of C(H|E) mostly involves repeated application of Equation A.2. Initially, C(H) is zero. Then, CF' is calculated using Equation A.1, and then C(H|E) using Equation A.2. Then, the next test type is evaluated, which has a new CF and C(E) associated with it. The CF' is then recalculated. For the new test type, the certainty C(H) is set equal to C(H|E) determined from the previous test type. The C(H) and CF' in Equation A.1 are used to calculate the new C(H|E). This process is repeated for each test type to obtain an overall certainty that the material conforms to the selected DEMAC.

Once the overall certainty that the material conforms to the selected DEMAC is assessed, the next likely class is selected, and the process repeated using the same set of information. In some situations, this evaluation may require that the conformance to five or more classes is evaluated. Although this seems cumbersome, the calculations are simple, and the process can easily be automated using a spreadsheet macro or computer program.

A.4 TESTS AND INTERPRETATION OF RESULTS

This section details the tests that are used for the material classification, the interpretation of the test results and the certainty factors. Classification systems for two materials are covered subsequently: Granular materials and cement stabilised materials.

The previous edition (TG2, 2009) included a separate system for the classification of BSMs to assess the suitability of a material for treatment with bitumen emulsion or foamed bitumen. Materials were assessed essentially using the same tests and indicators as for granular materials, with the addition of BSM mix test results from the mix design process. In this edition, the required BSM Class is determined using the mix design process outlined in Chapter 4. Whilst the BSM mix design process inherently accommodates evaluation of the suitability of the material for bitumen stabilisation, the material classification system complements this process by assessing the

parent material class based on a larger sample size thereby addressing risks associated with in situ material variability.

Existing, old, BSM layers can be classified using the granular system. Standardisation of BSMs to the maximum addition of 1% active filler results in behaviour similar to granular materials, compared to that of cemented materials. Therefore, based on the principles described in Section A.2.2, the old BSM therefore exhibits in situ shear strength, stiffness and flexibility properties similar to a new granular material represented by the assigned DEMAC.

Good confidence and experience with the system were gained during the previous validation (Johns, 2009) and implementation since its release. In the review for this 2020 edition, the system values shown in the tables to follow were validated and updated with datasets available from the Pavement Performance Information System (PPIS) (Hefer and Jooste, 2008) and supplemental project data.

A.4.1 Granular Materials

The classification of granular materials originally based on TRH14 (1985) is updated in this edition and aligned with the COTO Draft Standards (2019). The indicators and tests for the classification of granular materials are detailed in Table A.4, and the relevance of the test or indicator is explained. Interpretation ranges for materials statistics are given in Table A.5 (Laboratory Indicators and Tests) and Table A.6 (In Situ and Field Indicators and Tests).

The interpretation of grading, consistency, visible moisture and historical performance requires the determination of a rating. Ratings are assigned using Tables A.5 and A.6 with statistics calculated in the same way as for other data sets. Additional details on the assignment of ratings are provided in Table A.7 (Historical Performance), Table A.8 (Consistency) and Figures A.4 and A.5 (Grading).

When appropriate, the use of historical performance data can be valuable and add sensitivity to the classification process. Guidelines for when these data can be used are given in the notes in Table A.7. These inputs can conveniently be determined from data available at the condition assessment stage, including typical failure mechanisms observed during the visual assessment and rut measurements performed using a standard 2-meter straight edge. Laser profilometer rutting data are normally available from pavement management systems or collected as part of the investigation. Rutting data should be interpreted based on appropriate percentile levels, i.e., design reliability, according to industry guidelines. The primary input to the rating assessment is the appropriate rut statistic and sample size used this calculation over the section length. Visual data are secondary and allude to the appropriate and typical mechanism of distress under consideration.

This edition includes improved interpretation of gradings for crushed stone materials based on the 2019 COTO Draft Standards incorporated in Figure A.4. The interpretation of natural gravel and gravel soil gradings remain unchanged as shown in Figure A.5. The following standard envelopes form the basis of primary zones shown in Figures A.4 and A.5.

Table A.3 Standard Grading Envelopes that Constitute Figures A.4 and A.5

Material	Rating Zone	Grading Envelope Reference
Crushed Stone (Figure A.4)	≤1	COTO DS (2019): G1 (37.5 mm max. size)
	≤2	COTO DS (2019): G2/G3 (37.5 mm max. size)
	≤3	COTO DS (2019): G3 (28 mm max. size)
	≤4	COTO DS (2019): G4A/G5A (50 mm max. size)
Natural Gravel/Gravel Soil (Figure A.5)	≤1	TRH14 (1985): G4 or COTO DS (2019): G4A/G5A

Table A.4 Indicators and Tests for Classification of Unbound Granular Materials

Test or Indicator	Relevance for Material Classification	Interpretation or Rating	Comments
Grading Assessment Rating	Rating quantifies the conformance of the material grading to applicable specifications. Good conformance to grading indicates increased frictional resistance.	Table A.5 Figure A.4 Figure A.5	Rating requires that the relative conformance to the appropriate grading is quantified. This value is then used to obtain an overall rating for the grading based on material type. COTO Draft Standard (2019).
Grading Modulus	Quantifies the relative amount of fines in the material. As such, it influences the ability of the material to develop interlock between coarse particles.	Table A.5	Based on TRH14 and on COTO Draft Standard (2019) specifications.
Percent Passing 0.075 mm Sieve (Fines)	Impacts the density that can be achieved, and on the bearing strength of the material. As such, relates mainly to the frictional component of shear strength.	Table A.5	Ideal range is 6 to 10%. At less than 4% fines, density is difficult to achieve. Shear strength reduces when fines exceed roughly 13% (Hefer and Scullion, 2002; Gray, 1962).
Fractured Faces (Crushed stone)	Indicator of shape, angularity and surface texture and relates to the frictional strength. Inclusion of this simple parameter adds sensitivity to the system for classification of high quality crushed stone.	Table A.5	Based on COTO Draft Standard (2019). Material retained on the 5 mm sieve and above. G1: 100% fractured faces; G2 to G5: 50% (by mass of material) has at least 1 fractured face.
Plasticity Index (P0.425 and P0.075)	Determines the influence of water on shear strength. For a fixed maximum aggregate size, shear strength is greatly reduced with an increase in PI. The PI of the P0.075 applies to crushed stone, check for presence of secondary minerals, and provides improved sensitivity.	Table A.5	Based on TRH14 and COTO Draft Standard (2019). Test relevance and main effects related to shear strength are reported in Theyse (2007), Hefer and Scullion (2002), and in Gray (1962).
Linear Shrinkage	Determines the influence of water on shear strength. This parameter is a good indicator of performance and relates to friction angle at high moisture levels. Research suggests that LS carries more weight compared to PI in its ability to control performance.	Table A.5	Based on TRH14 and COTO Draft Standard (2019). Test relevance and main effects related to shear strength are reported in Theyse (2007).
Soaked CBR	When soaked, tests mainly the frictional strength component of shear strength.	Table A.5	Test relevance and interpretation is based on TRH14 and COTO Draft Standard (2019).
Consistency Rating	Provides a rough indication of material density and stiffness.	Table A.6 Table A.8	Rating based on material consistency evaluation from test pits.
Relative Density	Relates to the density of packing of particles, and hence to the potential to develop frictional resistance.	Table A.6	Test relevance and interpretation is based on TRH14 and COTO Draft Standard (2019).
Visible and Measured Moisture Content	The relative moisture content is the measured moisture content, relative to the optimum moisture content for the material. It provides an indication of the degree of saturation and the relative cohesive strength.	Table A.6	Rating and limits are based on experience, and on specifications reported by Hefer and Scullion (2002). These include the specifications of New South Wales (1997), and Queensland (1999).
DCP Penetration	Indicator for overall shear strength. Sensitive to density, moisture content, particle strength, grading and plasticity.	Table A.6	Test relevance and interpretation is based on experience and ranges published by Kleyn (1984).
FWD Backcalculated Stiffness	Provides a direct but relative indication of the stiffness under dynamic loading for most materials. Likely to be highly correlated to shear strength at small strains.	Table A.6	Test relevance and interpretation ranges based on experience in southern Africa. Deflection-derived stiffnesses are dependent on the pavement system, device and analysis method. Results can be highly variable and anomalous.
Historical Performance	The historical performance for the base and subgrade can be isolated with some confidence using past traffic and observed condition.	Table A.6 Table A.7	Based on experience and existing guidelines. e.g., TRH12, 1998.

Table A.5 Interpretation of Laboratory Indicators and Tests for Classification of Granular Materials

Test or Indicator	Material	Design Equivalent Material Class										CF
		DE-G1	DE-G2	DE-G3	DE-G4	DE-G5	DE-G6	DE-G7	DE-G8	DE-G9	DE-G10	
Grading* (Figures A.4, A.5)	CS	< 1.5	1.5 to 2.5	2.5 to 3.5	3.5 to 4.5	3.5 to 4.5	> 4.5					0.45
	NG				< 1.5	1.5 to 2.5	2.5 to 3.5	> 3.5				
	GS					< 1.5	1.5 to 2.5	2.5 to 3.5	3.5 to 4.5	3.5 to 4.5		
Grading Modulus	CS	2.3 to 2.6	2.2 to 2.6	2.1 to 2.6	2.0 to 2.6	2.0 to 2.6	1.2 to 2.6					0.2
	NG				1.5 to 2.4	1.5 to 2.4	1.2 to 2.6	0.75 to 1.5				
	GS/SSC						1.2 to 2.6	0.75 to 2.7	0.75 to 2.7	0.75 to 2.7	< 0.75	
Fractured Faces	CS	100	50 to 99	50 to 99	50 to 99	50 to 99	0 to 50					0.3
P0.075 (%)	CS	4 to 10	4 to 12	4 to 12	5 to 15	5 to 15	15 to 25					0.3
	NG				< 15	13 to 20	15 to 25	25 to 30	30 to 40	40 to 50	> 50	
	GS					5 to 15	13 to 20	15 to 25	25 to 30	30 to 40	> 40	
	SSC						0 to 10	10 to 15	15 to 20	20 to 30	> 30	
Plasticity Index	CS	< 4	2 to 6	2 to 6	2 to 6	6 to 10	10 to 15					0.3
	NG			< 6	2 to 6	4 to 10	8 to 12	> 12				
	GS						< 12	4 to 14	6 to 16	8 to 18	>16	
	SSC						< 12	6 to 15	12 to 20	> 20		
PI of P0.075	CS	< 8	4 to 12	4 to 12	8 to 16							0.3
Linear Shrinkage	CS	< 2	1 to 3	1 to 3	1 to 3	3 to 5	5 to 7					0.35
	NG			< 3	1 to 3	2 to 5	2 to 7	> 7				
	GS						< 7	< 8	4 to 9	6 to 16	>8	
	SSC						< 8	< 8	4 to 12	8 to 16	> 8	
Soaked CBR (%)	CS (100%)	> 100	80 to 99			45 to 79	25 to 44	15 to 24	10 to 14	7 to 9	< 7	0.25
	NG (95%)					> 45	25 to 44	15 to 24	10 to 14	7 to 9	< 7	
	GS (93%)						> 25	15 to 24	10 to 14	7 to 9	< 7	
	SSC (93%)							> 15	10 to 14	7 to 9	< 7	

Abbreviations: CS = crushed stone, NG = natural gravel, GS = gravel soil, SSC = sand-silt-clay types; 100%, 95%, 93% are % MDD (Mod AASHTO)

Note: * "2.5 to 3.5" denotes interpretation range of grading rating statistic from 2.5 to 3.5

Table A.6 Interpretation of In Situ or Field Indicators and Tests for Classification of Granular Materials

Test or Indicator	Material	Design Equivalent Material Class										CF
		DE-G1	DE-G2	DE-G3	DE-G4	DE-G5	DE-G6	DE-G7	DE-G8	DE-G9	DE-G10	
Consistency rating* (Table A.8)	CS	1 - V Dense < 1.5	2 - Dense 1.5 to 2.5	3 - M Dense 2.5 to 3.5	4 - Loose 3.5 to 4.5	5 - V Loose > 4.5						0.2
	NG			3 - V Dense < 3.5	4 - Dense 3.5 to 4.5	5 - M Dense 4.5 to 5.5	6 - Loose 5.5 to 6.5	7 - V Loose > 6.5				
	GS					5 - V Dense < 5.5	6 - Dense 5.5 to 6.5	7 - M Dense 6.5 to 7.5	8 - Loose 7.5 to 8.5	9 - V Loose > 8.5		
	SSC						6 - V Stiff < 6.5	7 - Stiff 6.5 to 7.5	8 - Firm 7.5 to 8.5	9 - Soft 8.5 to 9.5	10 - V Soft > 9.5	
Relative density (%)	All	> 102	100 to 102	98 to 100		95 to 98	93 to 95		< 93			0.3
Visible moisture rating*	CS	1 - Dry < 1.5	2 - S Moist 1.5 to 2.5	3 - Moist 2.5 to 3.5	4 - V Moist 3.5 to 4.5	5 - Wet 4.5 to 5.5						0.2
	NG		2 - Dry < 2.5	3 - S Moist 2.5 to 3.5	4 - Moist 3.5 to 4.5	5 - V Moist 4.5 to 5.5	6 - Wet < 5.5					
	GS					5 - Dry < 5.5	6 - S Moist 5.5 to 6.5	7 - Moist 6.5 to 7.5	8 - V Moist 7.5 to 8.5	9 - Wet > 8.5		
	SSC						6 - Dry < 6.5	7 - S Moist 6.5 to 7.5	8 - Moist 7.5 to 8.5	9 - V Moist 8.5 to 9.5	10 - Wet > 9.5	
Relative moisture (%)	CS	< 60	60 to 65	65 to 80	80 to 90	90 to 100	> 100					0.4
	NG			< 65	65 to 70	70 to 80	80 to 100	> 100				
	GS						< 80	80 to 90	90 to 100	> 100		
	SSC							< 90	90 to 100	100 to 120	> 120	
DCP Pen (mm/blow)	All	< 1.40	1.40 to 1.79	1.80 to 1.99	2.00 to 3.69	3.70 to 5.69	5.7 to 9.09	9.1 to 13.99	14 to 18.99	19.0 to 25.0	> 25	0.4
FWD-derived Stiffness (MPa)	All	> 600	500 to 600	400 to 499	300 to 399	200 to 299	150 to 199	100 to 149	70 to 99	50 to 69	0 to 49	0.3
Historical Performance	All	< 1.5	1.5 to 2.5	2.5 to 3.5	3.5 to 4.5	4.5 to 5.5	5.5 to 6.5	6.5 to 7.5	7.5 to 8.5	8.5 to 9.5	> 9.5	0.2
Abbreviations: CS = crushed stone, NG = natural gravel, GS = gravel soil, SSC = sand-silt-clay types; V = Very; M = Medium; DCP = Dynamic Cone Penetrometer; FWD = Falling Weight Deflectometer							Note: * "2-Dense" 1.5 to 2.5 denotes an assignment of rating of 2 for individual qualitative description and interpretation range for rating statistic of 1.5 to 2.5					

Table A.7 Rating of Historical Performance

Layer	Condition Description	Traffic Accommodated to Date (Million Equivalent Standard Axles)				
		< 0.5	0.5 to 1	1 to 3	3 to 10	> 10
Base ¹	No visible rutting, deformation, pumping or potholes, surfacing mostly intact. Minor patching only.	Difficult to assess		2	1	1
	Less than 8 mm narrow rutting in wheelpath, minor pumping and traffic-related cracking. Minor patching.	Difficult to assess	4	3	2	1
	8 to 12 mm narrow rutting in wheelpath, some deformation, shoving and/or pumping. Frequent patching noted.	7	5	4	3	Difficult to assess
	More than 12 mm narrow rutting in wheelpath, severe and frequent shoving, pumping and/or deformation. Frequent patching.	9	7	5	Difficult to assess	
Subgrade ²	No wide, subgrade relative rutting visible.	Difficult to assess		7	6	5
	Suspect some subgrade deformation occurred, as shown by wide, subgrade related rutting (<10 mm depth), and slight undulation and/or subgrade related failures.	Difficult to assess		8	7	6
	Strong evidence of subgrade related rutting (>10 mm depth) and/or definite signs of subgrade related failures.	10	9	8	Difficult to assess	

Note: Assessment is only valid if there are no surfacing related problems, e.g., stripping, brittleness, rutting, which may have caused a rapid deterioration in the base layer. Also, assessment is not valid if overlay or surface seal was recently placed. Assessment is only valid if an overlay or surface seal was not recently placed.

Table A.8 Guidelines for Consistency

Material	Consistency	Description of Layer Condition
Coarse Granular Materials	Very Loose	Very easily excavated with spade. Crumbles very easily when scraped with geological pick.
	Loose	Small resistance to penetration by sharp end of geological pick.
	Medium Dense	Considerable resistance to penetration by sharp end of geological pick.
	Dense	Very high resistance to penetration of sharp end; and requires blows of geological pick for excavation.
	Very Dense	Very high resistance to repeated blows of geological pick; and requires power tools for excavation.
Cohesive Soils	Very Soft	Geological pick head can easily be pushed in, up to the shaft of handle; easily moulded by fingers.
	Soft	Easily penetrated by thumb; sharp end of geological pick can be pushed in 30 to 40 mm; moulded with some pressure.
	Firm	Indented by thumb with effort; sharp end of geological pick can be pushed in up to 10 mm; very difficult to mould with fingers; can just be penetrated with an ordinary hand spade.
	Stiff	Penetrated by thumb nail; slight indentation produced by pushing geological pick point into soil; cannot be moulded by fingers; requires hand pick for excavation.
	Very Stiff	Indented by thumb nail with difficulty; slight indentation produced by blow of geological pick point; requires power tools for excavation.

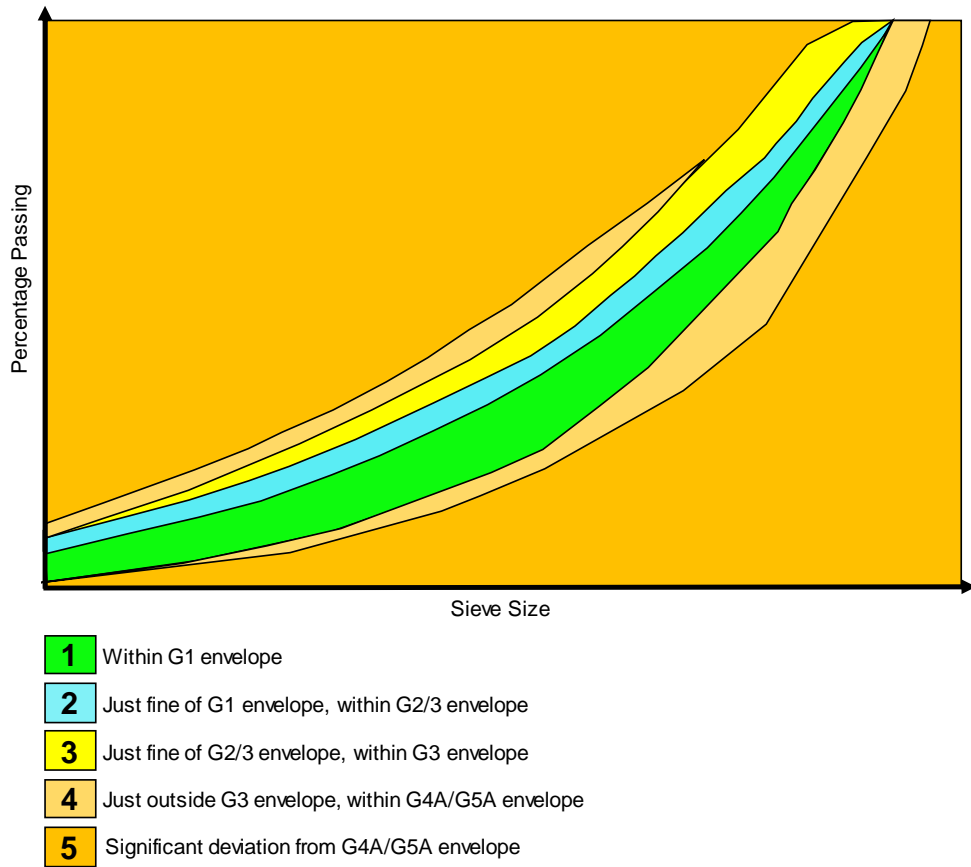

Figure A.4 Grading Rating to Quantify Relative Conformance to Crushed Stone Reference Envelopes

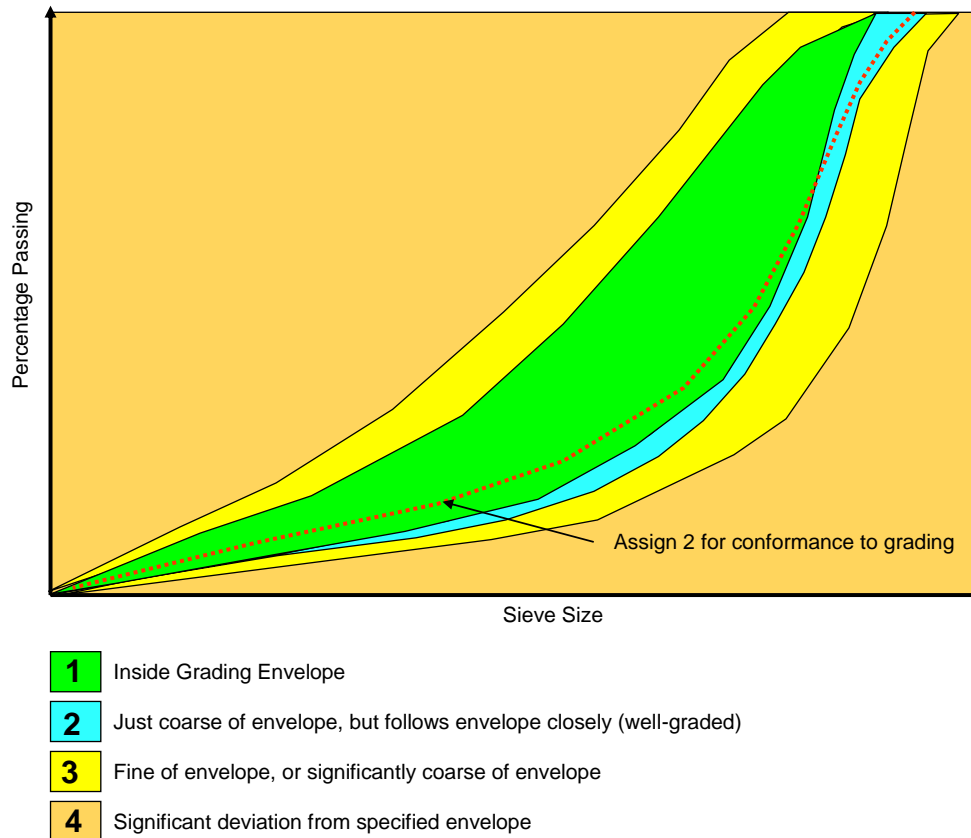

Figure A.5 Grading Rating to Quantify Conformance to Reference Envelope for Natural Gravel & Gravel Soil

A.4.2 Cement Stabilised Materials

The classification of cement stabilised materials focuses on the in situ layer quality, but also incorporates the laboratory tests to assess the quality of the broken-up material. The system for cemented materials is similar to the granular system and includes actual test or indicator results, as well as ratings. The traditional cemented material classes are supplemented with so-called equivalent granular (EG) classes that represent the condition of old cracked layers with stiffness values equivalent to good quality granular layers. This behaviour of cemented layers and the definition of EG classes have been adopted in South African pavement design methods (SAPEM, 2014).

The system for the classification of cemented layers assumes that the designer has knowledge that the layer under consideration is, or was, originally stabilised. This information may be available at an early stage from pavement management databases, or simply from data that becomes available during the investigation. For example, a visual inspection may reveal block cracking, an exposed base at the road edge or in a pothole may give sufficient evidence, or from inspection of test pits.

In this 2020 edition, the system uses four cemented classes:

- DE-C3: Indicates condition similar to recently constructed strongly cemented C3 or stronger material. Good quality strongly cemented crushed stone materials, C1 and C2, are seldom used in South Africa nowadays.
- DE-C4: Indicates condition similar to recently constructed C4 material.
- DE-EG4: Indicates a good quality cemented material deteriorated into small blocks, i.e., EG4 quality. Examples of strongly cemented base layers deteriorated to an equivalent granular state are shown in Figure A.6.
- DE-EG5: Indicates a lower quality cemented material deteriorated to an equivalent granular state EG5/6, or the material is ineffectively stabilised.



Figure A.6 Examples of Cemented Base Layers in an EG4 Stage of Deterioration

The indicators and tests for the classification of cemented materials are detailed in Table A.9, and the relevance of the test or indicator is explained. Interpretations of the test results are given in Table A.10.

TECHNICAL GUIDELINE: BITUMEN STABILISED MATERIALS
APPENDIX A: DESIGN EQUIVALENT MATERIAL CLASSIFICATION SYSTEM

Table A.9 Indicators and Tests for Classification of Cement Stabilised Materials

Test or Indicator	Relevance for Material Classification	Rating	Comments/ Relevance/ Reference
Consistency Rating	Provides a rough indication of the degree of cementation of the material.	Table A.10	Rating based on material consistency evaluation from test pits and on the SANRAL M1 Manual (SANRAL, 2004)
Evidence of Active Cement	Quantifies the confidence that material is acting as a cohesive, cement stabilised layer.	Table A.10	None
DCP Penetration	Indicator for overall shear strength. Sensitive to density, moisture content, particle strength, grading and plasticity.	Table A.10	Test relevance and interpretation is based on experience and ranges published Kleyn (1984).
FWD Maximum Deflection	Provides indirect indication of total pavement stiffness under dynamic loading. Good indicator of deterioration stage of cemented layers.	Table A.10	Test relevance and interpretation ranges based on experience in southern Africa.
FWD Backcalculated Stiffness	Provides a direct but relative indication of the stiffness under dynamic loading. Likely to be highly correlated to shear strength at small strains for most materials.	Table A.10	Test relevance and interpretation ranges based on experience in southern Africa.
Visual Condition	Direct evidence of cement stabilised base condition (and inferred condition of stabilised subbase where applicable). Good indicator of inherent shear strength (rut levels) and deterioration stage of cemented layer (degree and extent of transverse, longitudinal and block and even crocodile cracking)	Table A.10	Test relevance and interpretation ranges based on experience in southern Africa. Only applicable to assessment of cemented base layers and cemented subbase supporting a cemented base layer.
Grading Rating	Provides indication of parent material quality and potential performance of cemented material.	Table A.10 Figure A.5	TRH14 (1985) G4 envelope or COTO DS (2019) G4A and G4B grading envelope.
Plasticity Index	Provides indication of the effectiveness of stabilisation, parent material quality and potential performance of cemented material.	Table A.10	COTO DS (2019)
Soaked CBR	Provides indication of parent material quality and potential performance of cemented material.	Table A.10	COTO DS (2019)

Table A.10 Interpretation of Indicators and Tests for Classification of Cemented Materials

Test or Indicator	DE- C3	DE-C4	DE-EG4	DE-EG5	CF
Consistency*	1 - Hand-held specimen can be broken with hammer head with single firm blow or firm blows of sharp geological pick Similar appearance to concrete. < 1.5	2 - Cannot be crumbled between strong fingers. Some material can be crumbled by strong pressure between thumb and hard surface. Disintegrates under light blows of a hammer head to a friable state. Grains can be dislodged with some difficulty under a knife blade. 1.5 to 2.5		3 - Some material can be crumbled by strong pressure between fingers and thumb. Disintegrates under a knife blade to a friable state. > 2.5	0.2
Evidence of Active Cement*	1 - Clearly visible in material colour and consistency. Clear indication of active cement, based on chemical tests, typically Phph + HCl reaction < 1.5	2 - Some cementation visible, variable to slight indication of active cement, based on chemical tests, typically HCl reaction only. 1.5 to 2.5		3 - No indication of active cement, either in material colour and consistency or from chemical tests. > 2.5	0.3
DCP Penetration (mm/blow)	< 1.50	≤ 3.0		> 3.0	0.3
FWD-derived Stiffness (MPa)	> 1 200	500 to 1 200	250 to 800	< 250	0.3
FWD Maximum Deflection	< 350	350 to 450	450 to 800	> 600	0.35
Visual Condition	< 1.5 - Rutting < 5 mm. Transverse, longitudinal and/or block cracking present.	1.5 to 2.5 - Rutting < 8 mm. Transverse, longitudinal and/or block cracking present.	2.5 to 3.5 - Rutting > 8 mm. Moderate to high degree block cracking.	>3.5 - Rutting > 15 mm. High degree block to crocodile cracking.	0.35
Grading Rating (Fig A.5)	< 1.5	1.5 to 3.5		> 3.5	0.2
Plasticity Index	≤ 6			> 6	0.2
CBR (95%)	> 45	25 to 45	30 to 80	< 30	0.2

Abbreviations: Phph = Phenolphthalein; HCl = Hydrochloric acid; CBR (95%) = California Bearing Ratio at 95% of MDD (Mod AASHTO)

Note: * "2 - Some..." Denotes an assignment of rating of 2 for qualitative description and interpretation range or rating statistic of 1.5 to 2.5.

A.5 CONFIDENCE ASSOCIATED WITH ASSESSMENT AND RECOMMENDED APPLICATION

The confidence in the certainty associated with the material classes depends on the number of tests or indicators used and the certainty factors associated with the tests and indicators. The strength of confidence in the assessment is thus quantified by the certainty of the assessment, which is an indirect indicator of the reliability of any design based on this assessment. Table A.11 provides some guidelines to assess the confidence associated with the material classification, and guidelines for its use in rehabilitation design applications.

Table A.11 Relative Confidence of Materials Classification

Final Certainty (Final Value of C(H E))	Confidence in Classification and General Considerations	Recommended Application Service Level Considerations
< 0.3	Very low confidence. It is strongly recommended that more data is gathered to enable a more confident assessment.	Inadequate
0.3 to 0.5	Low confidence. Suitable only for situations where the existing pavement condition and age is such that structural rehabilitation is not considered or is very unlikely.	Category D Roads
0.5 to 0.7	Medium. Suitable for situations where the existing pavement condition and age is such that structural rehabilitation is unlikely, or for which the condition and/or other factors predetermines the treatment type.	Category C Roads 0.5 to 0.6
		Category B Roads 0.6 to 0.7
> 0.7	High. This is the minimum recommended certainty for situations where structural rehabilitation is likely, and for which the rehabilitation design will rely completely on the quality and state of existing pavement layers.	Category A Roads

Although the Material Classification System was originally developed for use in rehabilitation design applications, evaluations done as part of the revision for this edition demonstrated its potential use for the assessment of materials in greenfields applications. A database of materials that conform to the material class limits specified in the COTO Design Standard (2019) was compiled. Simplified distributions for each of the parameters outlined in Table A.5 were set up with the specification limits representing the limits of the triangular distribution and the midpoint representing the median. This assessment, excluding any in situ parameters, indicates that materials can generally be classified with a certainty above 0.8. Authorities may therefore consider specifying a minimum certainty of 0.8 for materials used in new construction (*Johns and Hefer, 2020*).

A.6 WORKED EXAMPLE

The following paragraphs illustrate the application of the DEMAC method described in Section A.3. The example involves an assessment of an upper subbase layer for the eastbound lane of a planned 18 km long rehabilitation project.

Based on the condition of the road, the construction history and the deflection patterns, the full 18 km section was designated as a single uniform design section. All available results are therefore assessed together. The available information consists of the following:

- **Materials test data from nine test pits.** Available test data include: material description, relative density, moisture content, DCP penetration, grading analyses, CBR and PI.

- **173 FWD deflections** with backcalculated stiffnesses for all layers. Table A.12 summarises some of the test indicators. The grading analyses are summarised in Figure A.7. In the test pits, the material was described as a dense weathered dolerite natural gravel in all instances confirmed by an analysis of fractions, i.e. for the majority of gradings, the sum of coarse gravel, gravel and sand fractions exceeds the sum of gravel, sand and silt/clay fractions (see definitions in Table A.1).

Table A.12 Example Materials Test Data

Station (km)	Relative Density	CBR (%)	% Passing 0.075 mm Sieve	Moisture as % of Optimum	GM	PI	Consistency Rating ¹	Grading Rating ²	DCP Pen (mm/blow) ³
1.5	1.03	70	11	70	2.34	9	4	1	1.8
2.7	0.87	24	4	108	2.70	10	4	3	4.8
4.3	0.94	64	5	91	2.67	9	4	2	-1
4.9	1	66	6	96	2.65	7	4	2	-1
7.9	1	70	13	67	2.17	8	4	1	-1
9.2	1	100	3	75	2.68	8	4	2	-1
12.5	1	90	12	63	2.24	5	4	1	2.4
14.3	0.98	80	6	72	2.59	8	4	1	1.4
17.5	0.94	N/R	10	48	2.24	6	4	2	-1
10 th Percentile	0.93	52	3.8	60	2.2	6	4	1	-1.0
Median	1.00	70	6.0	72	2.6	8	4	2	-1.0
90 th Percentile	1.01	93	12.2	98	2.7	9	4	2	2.9
Observations	9	8	9	9	9	9	9	9	9

Note:

1. Consistency rating determined from Table A.8 and Table A.6.
2. Grading rating determined from Figure A.5 and Table A.5.
3. For DCP penetration, a value of -1 indicates refusal.

The backcalculated stiffnesses for the subbase were as follows:

- 10th Percentile = 189 MPa
- Median = 466 MPa
- 90th Percentile = 581 MPa

For most of the available tests, the results can be directly evaluated by means of the interpretation guidelines provided in Section A.4, Tables A.5 and A.6. However, consistency and grading data need to be converted to appropriate ratings first using Table A.6 with Table A.8 and Figure A.5, respectively, before numerical evaluation proceeds.

Once all the tests have been quantified, the statistics of the available test data and CFs are summarised. The CFs are given in Table A.5 and Table A.6. Since the sample size exceeds six for all tests, the adjustment factor for sample size (from Table A.2) is 1.0 for all tests. For this example, the available test data and certainty factors are summarised in Table A.13.

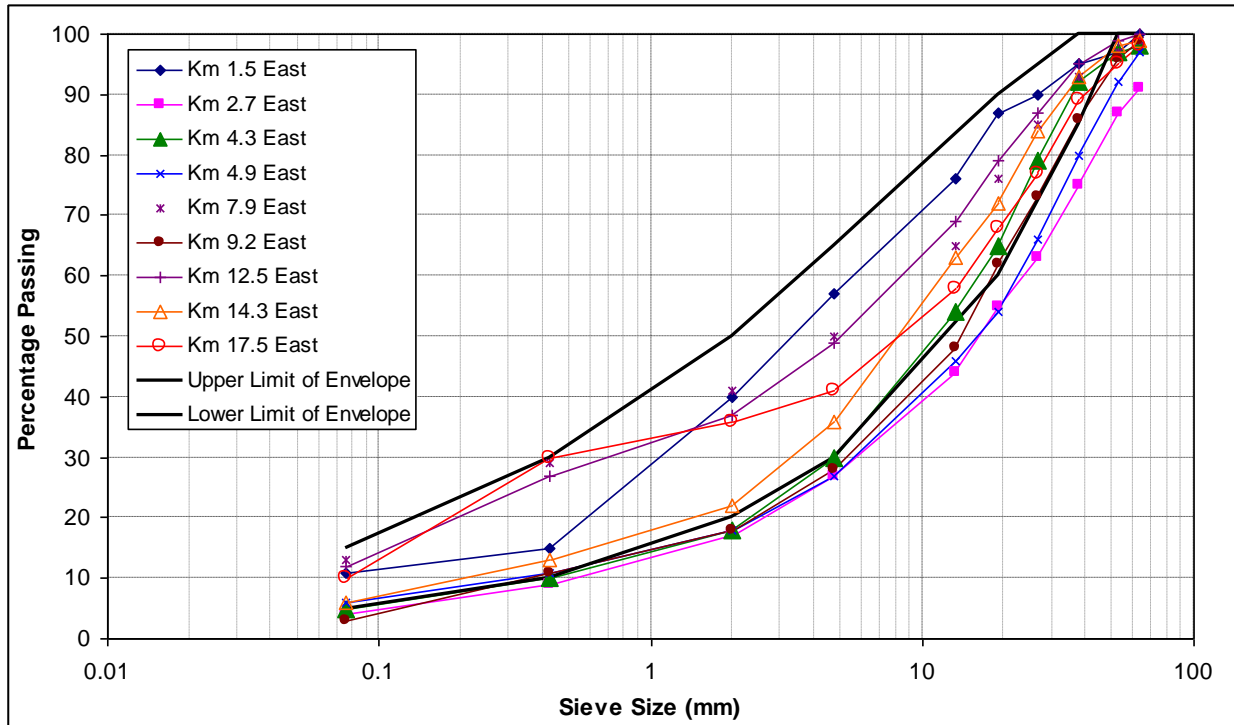

Figure A.7 Grading Analyses for Worked Example

Table A.13 Worked Example, Summary of Test Data and Certainty Factors

Test	CF ₁	CF ₂	10 th %	Median	90 th %	C(E) DE-G4	C(E) DE-G5	C(E) DE-G6
Grading Rating (NG)	0.45	0.45	4	5	5	0.25	0.75	0.00
GM (NG)	0.20	0.20	2.2	2.6	2.7	0.20	0.20	0.80
P0.075 (NG)	0.30	0.30	3.8	6.0	12.2	0.92	0.00	0.00
PI (NG)	0.30	0.30	6	8	9	0.00	1.00	0.33
CBR (95%)	0.25	0.25	52	70	93	0.00	1.00	0.00
Consistency Rating	0.20	0.20	4	4	4	1.00	0.00	0.00
Relative Density	0.30	0.30	0.93	1.00	1.01	0.43	0.38	0.07
Rel. Moisture (NG)	0.30	0.30	60	72	98	0.21	0.44	0.29
DCP Penetration	0.30	0.30	-1.0	-1.0	2.9	0.05	0.00	0.00
FWD Stiffnesses	0.30	0.30	189	466	581	0.30	0.11	0.00
Column	1	2	3	4	5	6	7	8

In Table A.13, CF₁ is the certainty factor related to the test type, and CF₂ is simply CF₁ adjusted to take account of sample size. In this case, CF₂ is equal to CF₁ because the sample size is greater than 6 in all cases. Columns 6, 7 and 8 represent the relative certainty that the test evidence points to a DE-G4, DE-G5 or DE-G6 design equivalent material class.

The factors C(E) are determined using the method described in Section A.3.1. Figure A.8 shows an example of the detailed calculation of C(E) for FWD Back-calculated Stiffness. This calculation relies on the FWD stiffness limits recommended in Table A.6 and on the sample statistics shown highlighted for FWD stiffness in Table A.13.

TECHNICAL GUIDELINE: BITUMEN STABILISED MATERIALS
APPENDIX A: DESIGN EQUIVALENT MATERIAL CLASSIFICATION SYSTEM

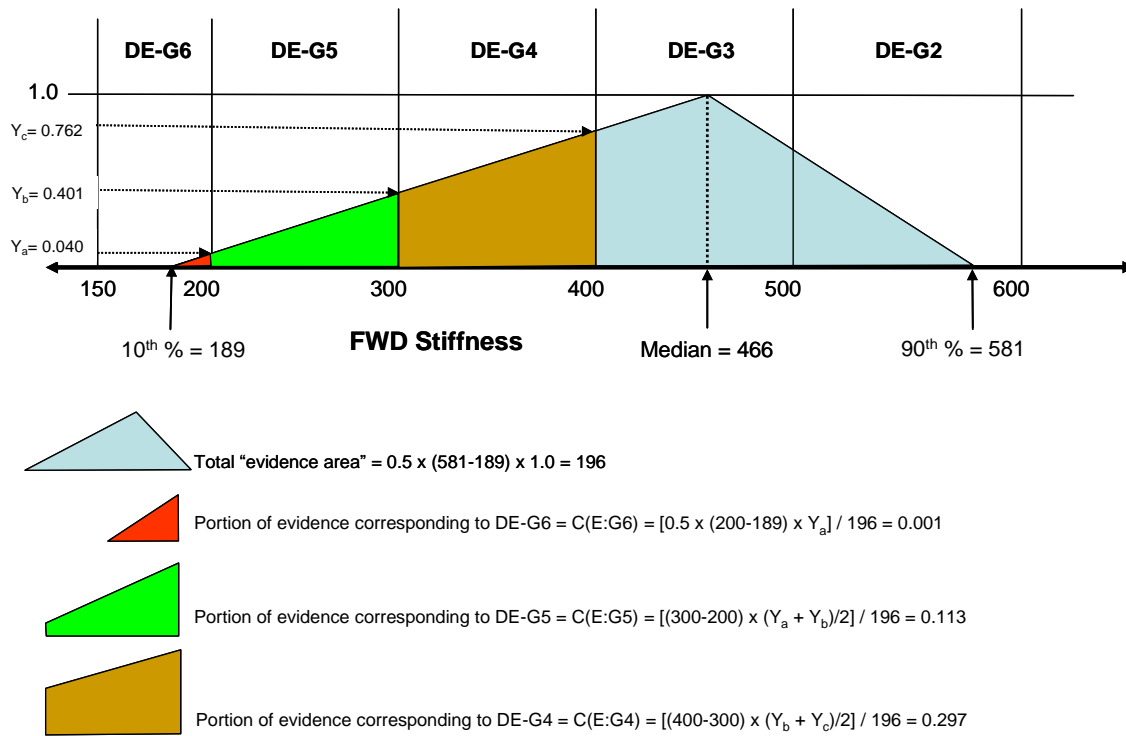

Table A.14 shows the final adjusted certainty factors (CF'), determined using Equation A.2.1., for a DE-G4, DE-G5 and DE-G6 material, and also the cumulative certainty that the material is a DE-G4, DE-G5 or DE-G6 (i.e., C(H|E)). The final cumulative certainty for these three material classes is shown in the bottom row. The classification method shows that most of the evidence points to the material being a DE-G5, and some evidence also points to a DE-G4. In comparison to a DE-G4 and DE-G5, there is comparatively little information to suggest that the material is a DE-G6.

Table A.14 Worked Example, Summary of Certainty associated with DE-G4, DE-G5 and CE-G6

Test	CF'			C(H-DEGX E)		
	DE-G4	DE-G5	DE-G6	DE-G4	DE-G5	DE-G6
Grading Rating	0.11	0.34	0.00	0.00	0.34	0.00
GM	0.04	0.04	0.16	0.15	0.36	0.16
P0.075	0.28	0.00	0.00	0.38	0.36	0.16
PI	0.00	0.30	0.10	0.38	0.55	0.24
CBR	0.00	0.25	0.00	0.38	0.67	0.24
Consistency Rating	0.20	0.00	0.00	0.51	0.67	0.24
Relative Density	0.13	0.11	0.02	0.57	0.70	0.26
Measured Moisture	0.08	0.18	0.12	0.61	0.76	0.35
DCP Penetration	0.02	0.00	0.00	0.61	0.76	0.35
FWD Stiffnesses	0.09	0.03	0.00	0.65	0.76	0.35
Final Assessment of Relative Certainty for				DE-G4 = 0.65	DE-G5 = 0.76	DE-G6 = 0.35
Most likely Materials Class is a G5 Design Equivalent Class						
Relative Certainty associated with this outcome = 0.76						
Confidence associated with this outcome is High .						
Assessment is suitable for situations where structural rehabilitation is required, or for which the rehabilitation design will rely completely on the state of existing layers.						

Note: CF' calculated with Equation A.1
C(H-G4/G5/G6|E) calculated with Equation A.2.1

A.7 REFERENCES

- ASPHALT Academy. 2009. **Technical Guideline 2: Bitumen Stabilised Materials – A Guideline for the Design and Construction of Bitumen Emulsion and Foamed Bitumen Stabilised Materials (TG2)**. Second Edition. ISBN 978-0-7988-5582-2. Asphalt Academy, CSIR Built Environment, Pretoria.
- COLTO. 1998. **Standard Specifications for Road and Bridge Works for State Authorities**. Committee of Land Transport Officials, Halfway House, South Africa.
- COTO Draft Standard (DS). 2019. **Standard Specifications for Road and Bridge Works**. Committee of Transport Officials. The South African Roads Agency (SOC) Limited, Pretoria, South Africa.
- GRAY, J.E. 1962, Characteristics of Graded Base Course Aggregates Determined by Triaxial Tests. **National Crushed Stone Association, Engineering Bulletin No. 12**, National Crushed Stone Association, Washington, D.C.
- HEFER, A and Scullion, T. 2002. Materials, Specifications, and Construction Techniques for Heavy Duty Flexible Bases: Literature Review and Status Report on Experimental Sections. Texas Transportation Institute, The Texas A&M University System, College Station, Texas (Report 0-4358-1), October 2002 (Resubmitted: July 2005).
- HEFER, A.W. and Jooste, F.J. 2008. **Development of a Pavement Performance Information System (PPIS)**. Revision of the South African Pavement Design Method, Project PB/2006/PBIS. The South African National Roads Agency Ltd., Pretoria.
- JOHNS, F.M. and Hefer, A.H. 2020. **Revision of the Pavement Number Pavement Design Method and the DEMAC Material Classification System**. Rubicon Solutions. Johannesburg. South Africa.
- JOOSTE, F.J., F.M. Long, and A.W. Hefer. 2007. **A Method for Consistent Classification of Materials for Pavement Rehabilitation and Design**. Technical Memorandum. Modelling and Analysis Systems, Cullinan, South Africa. SABITA/Gauteng Department of Public Transport, Roads and Works, Pretoria, 2007. (GDPTRW report number: CSIR/BE/IE/ER/2007/0005/B).
- KLEYN, E.G. 1984. **Aspects of Pavement Evaluation and Design as Determined with the Aid of the Dynamic Cone Penetrometer**. (In Afrikaans). Pretoria: Transvaal Roads Department, Materials Branch, May 1984 (Report L6/84).
- LONG, F.M. 2009. **Validation Report**. Technical Memorandum. Modelling and Analysis Systems, Cullinan, South Africa. SABITA/Gauteng Department of Public Transport, Roads and Works, Pretoria, 2008. (GDPTRW report number: CSIR/BE/IE/ER/2007/0006/B).
- NCHRP. 2001. **Performance-Related Tests of Aggregates for Use in Unbound Pavement Layers**. National Cooperative Highway Research Program, Report 453. Transportation Research Board – National Research Council, National Academy Press, Washington D.C.
- ROADS and Traffic Authority of New South Wales. 2001. **RTA Conditions of Contract and Quality Assurance Specifications, Rev 2001**. Roads and Traffic Authority of New South Wales (web reference: <http://www.rta.nsw.gov.au>).
- SANRAL. 2004. **Geotechnical and Materials Investigations, Design and Documentation**. South African National Roads Agency Limited. Pretoria, South Africa (M1 Materials Manual).
- SAPEM. 2014. **The South African Engineering Manual, Chapter 10: Pavement Design**. Second Edition. ISBN 978-1-920611-10-1. The South African National Roads Agency SOC Limited. Pretoria
- STANDARD Specifications Roads, 3rd Edition, Queensland, Department Main Roads. Web reference <http://www.mainroads.qld.gov.au>.
- THEYSE, H.L., De Beer, M. and Rust, F.C. 1996. **Overview of the South African Mechanistic Pavement Design Analysis Method**. Paper Number 961294 Presented at the 75th Annual Transportation Research Board Meeting, January 7 to 11, 1996, Washington, D.C.

THEYSE, H.L. 2007. **A Mechanistic-Empirical Design Model for Unbound Granular Pavement Layers**. Doctoral Thesis. University of Johannesburg, March 2007, Johannesburg.

TRH12. 1998. **Flexible Pavement Rehabilitation Investigation and Design**. Committee of State Road Authorities. Pretoria, South Africa. (Technical Recommendations for Highways Series, TRH 12).

TRH14. 1985. **Guidelines for Road Construction Materials**. Committee of State Road Authorities. Pretoria, South Africa. (Technical Recommendations for Highways Series, TRH 14).

APPENDIX B: LABORATORY TESTS

BSM1:	DETERMINING THE FOAMING CHARACTERISTICS OF BITUMEN.....	130
BSM2:	LABORATORY MIX DESIGN OF BITUMEN STABILISED MATERIAL	137
BSM3:	VIBRATORY HAMMER COMPACTION OF TEST SPECIMENS OF BITUMEN STABILISED MATERIAL.....	149
BSM4:	DETERMINATION OF THE INDIRECT TENSILE STRENGTH OF BITUMEN STABILISED MATERIAL	157
BSM5:	DETERMINATION OF THE SHEAR PROPERTIES OF BITUMEN STABILISED MATERIAL (TRIAxIAL TEST) .	165

BSM1: DETERMINING THE FOAMING CHARACTERISTICS OF BITUMEN

1. SCOPE

This test method concerns the determination of the foaming characteristics of bitumen.

2. REFERENCES

The following referenced documents are indispensable for the application of this test method. For dated references, only the edition cited applies. For undated references, the latest edition of the referenced document (including any amendments) applies. Information on currently valid national and international standards can be obtained from the SABS Standards Division.

- ASTM D140. Standard Practice for Sampling Bituminous Materials.
- SANS 1649. Non-automatic self-indicating, semi-self-indicating and non-self-indicating weighing instruments with denominated verification scale intervals.
- TG2, Test Method BSM2. Laboratory mix design of bitumen stabilised material.
- TG2, Test Method BSM3. Vibratory hammer compaction for test specimens of bitumen stabilised material.
- TG2, Test Method BSM4. Determination of the indirect tensile strength of bitumen stabilised material.
- TG2, Test Method BSM5. Determination of the shear properties of bitumen stabilised material (Triaxial test).
- TG2, Bitumen Stabilised Materials guideline for the Design and Construction of Bitumen Emulsion and Foamed Bitumen Stabilised Materials.
- TMH 5, Sampling methods for road construction materials. Pretoria.

3. DEFINITIONS

3.1 Binder

Bitumen and bituminous materials. Avoid using the term “binder” with bitumen stabilised materials (BSMs). This is important as it disassociates BSMs from asphalt.

3.2 Binder content

This is another term that is associated with asphalt. It is preferable to talk about “added bitumen” for BSMs, mainly because, unlike asphalt, you cannot determine the “binder content” after the event.

3.3 Bitumen stabilised material (BSM)

Granular, previously cement treated or reclaimed asphalt material blends, stabilised either using bitumen emulsion or foamed bitumen.

3.4 Constant mass

Less than 0.1% change in mass after two successive (more than 4 hours) periods of oven-drying.

3.5 Expansion ratio

A measure of the viscosity of the foamed bitumen, calculated as the ratio of the maximum volume of the foam relative to the original volume of bitumen.

3.6 Half-Life

A measure of the stability of the foamed bitumen, calculated as the time taken in seconds for the foam to collapse to half its maximum volume.

4. APPARATUS

4.1 Electronic balance

Fine measurement type that complies with SANS 1649, with a capacity of 10 kg and reading to 0.1 g.

4.2 Foamed bitumen laboratory unit

Capable of producing foamed bitumen at a rate of between 50 g and 200 g per second. The method of producing the foamed bitumen shall closely simulate that used in full-scale production. The laboratory unit shall be equipped with a thermostatically controlled kettle, capable of holding a mass of 10 kg of bitumen at a constant temperature within the range of 160 and 190 ± 5 °C. The unit is to be equipped with a water injection system, where the mass of water injected into the hot bitumen can be variable from 0 to $5 \pm 0.25\%$, by mass of the bitumen. To assist in achieving a uniform foam, the water is injected together with compressed air. The unit shall be capable of producing a predetermined mass of foamed bitumen directly into the container or laboratory mixer.

Note: A Wirtgen WLB10S is an example of a suitable foamed bitumen laboratory unit available commercially. This information is given for the convenience of users of this standard and does not constitute an endorsement of this product.

4.3 Cylindrical metal container

With a diameter of 275 ± 5 mm and a capacity of 20 litres.

4.4 Calibrated dipstick

Metal, with prongs. The spacing between each of the 5 prongs indicates the expansion of a mass of 500 g of bitumen when foamed in the container.

4.5 Stopwatch

Reading to 1 second.

4.6 Safety equipment

Including:

- a) safety glasses or face shield
- b) protective gloves, well insulated and capable of withstanding 200 °C
- c) long sleeved jacket

4.7 Sealable steel containers

Capacity approximately 5 litres.

4.8 Drying ovens

Capable of maintaining a temperature range of 105 °C to 180 °C with continuous draft or by convection, for preheating the bitumen prior to testing. A second oven to preheat the cylindrical metal container to 75 °C.

4.9 Plastic beaker

Capacity 0.5 litres.

4.10 Glass measuring cylinder

Capacity 50 millilitres.

4.11 Suitable waste receptacle

Capacity 10 litres, for bitumen and foamed bitumen.

5. HAZARDS

Warning: *The temperature of the bitumen in the kettle is high, while the foamed bitumen will also cause injury. Pouring hot bitumen into the unit's kettle is also hazardous. Therefore, exercise caution at all times when preparing the unit and carrying out the testing as failure to do so could result in serious injury or severe burns.*

It is important to follow the foamed bitumen unit's manufacturer's instruction manual carefully and take all necessary precautions.

6. PRINCIPLES

The objective is to determine the percentage of water required to produce the best foaming characteristics of a particular source of bitumen at three (3) different bitumen temperatures. The aim is to produce foamed bitumen with the largest expansion ratio and with the longest possible half-life.

7. PREPARATION

7.1 Preparation of the bitumen

- 7.1.1 Obtain the sample of bitumen in accordance with TMH 5, sealing it in the containers. Sample a minimum of 10 litres for determining the bitumen's foam characteristics.
- 7.1.2 Heat the bitumen in the oven to a temperature of 100 °C.

7.2 Preparation of the laboratory unit

- 7.2.1 Connect the unit to the electrical power supply and switch on.
- 7.2.2 Set the temperature control on the foamed bitumen laboratory unit to heat the kettle to the predetermined temperature (usually between 160 °C and 180 °C).

Note: The temperature set to produce the foamed bitumen depends upon the grade of bitumen, as well as for an investigation of the effect of bitumen temperature on foaming characteristics.
- 7.2.3 Remove the containers with the bitumen from the oven and pour 10 litres into the kettle.
- 7.2.4 Once the temperature of the bitumen in the kettle is above 140 °C, start the bitumen pump to circulate it through the system and continue circulating whilst heating to achieve the required temperature.
- 7.2.5 Fill the unit's water reservoir with potable water.
- 7.2.6 Weigh the 20 litre cylindrical metal container on the balance (M_1) and place it under the foamed bitumen outlet.
- 7.2.7 Set the bitumen discharge rate using the manufacturer's instructions, typically 100 g per second for 5 seconds.
- 7.2.8 Discharge bitumen for the pre-set time period into the container and weigh it again (M_2). Determine that the mass of bitumen discharged is $500 \text{ g} \pm 10 \text{ g}$. Empty the container into the waste receptacle. If the mass of discharged bitumen in the container falls outside this range, repeat the procedure, adjusting the timer until the discharge rate complies.
- 7.2.9 Set the injection rate with the water flow meter using the manufacturer's instructions. Discharge water for the pre-set period into the beaker. Transfer the water into the measuring cylinder and read the volume of water discharged. Determine that the volume of water is within 5% of the prescribed volume. If the volume of water falls outside this range, repeat the procedure, adjusting the water flow meter until the discharge rate complies.
- 7.2.10 Ensure that the dip stick is clean and the 20 litre cylindrical metal container is empty. Pre-heat the container in the oven for at least 5 minutes at 75 °C.

8. PROCEDURE

- 8.1 Circulate the bitumen in the kettle through the system at 160 °C for at least 5 minutes prior to testing.
- 8.2 Check that the correct settings have been made for the timer for the foamed bitumen discharge as well as the flow meter for the water injection.

Note: The water flow meter is normally set to inject 2% of water by mass of bitumen for the first testing cycle.

- 8.3 Discharge foamed bitumen into the pre-heated container for the time required to spray 500 g of bitumen.
- 8.4 Start the stopwatch immediately the foamed bitumen discharge starts.
- 8.5 Use the dipstick to estimate (to the nearest whole number) the maximum height that the foamed bitumen reaches in the container and record it as the maximum Expansion Ratio (ER = h_1).
- 8.6 Continue to measure the time that the foam takes to dissipate to half of its maximum volume in the container. When this point is reached, stop the stopwatch. Record the lapsed time to the nearest second as the foamed bitumen's half-life ($\tau_{\frac{1}{2}}$). Decant the foamed bitumen into the waste receptacle.
- 8.7 Repeat 8.3 to 8.6 at least three times until similar results are obtained ($h_2, \tau_{\frac{1}{2}2}; h_3, \tau_{\frac{1}{2}3}$).
- 8.8 Calculate and record the average values for the three most similar pairs of results for expansion ratio and half-life.
- 8.9 Determine the expansion ratio and half-life at other percentages of water, following steps 8.3 to 8.7. Typically, these values are determined by injecting 1%, 2%, 3%, and 4% of water by mass of bitumen.
- 8.10 Repeat 8.1 to 8.9 with the bitumen at two higher temperatures.

Notes:

- i. Typically, the two higher temperatures used for testing are 170 and 180 °C.
- ii. Under no circumstance should the bitumen be heated above 190 °C.

9. CALCULATIONS

- 9.1 Calculate the mass of bitumen discharged in 5 seconds. See Paragraph 7.2.7.

$$M_{bit} = (M_2 - M_1)$$

where:

M_{bit} mass of bitumen discharged in 5 seconds

M_1 mass of empty cylindrical metal container, expressed in grams (g)

M_2 mass of container and bitumen, expressed in grams (g)

- 9.2 Prepare a chart to plot the expansion ratio and half-life at the different percentages of water injected into the bitumen, in the following way:

Horizontal axis: Rate of injected water

Unit: Percentage (%)

Scale: 20 mm = 0.5%

Vertical axis:

Left Ordinate: Expansion Ratio

Unit: Times expansion

Scale: 5 mm = 1 time

Right Ordinate: Half-life

Unit: seconds

Scale: 5 mm = 2 seconds

- 9.3 Plot the Expansion Ratio obtained at each rate of injected water and join the points together.
- 9.4 Repeat 9.3 for Half-life.

9.5 Select the Optimum Water Injection Rate as the average of the two water contents required to meet the minimum requirements for Expansion Ratio and Half-life, respectively (see Chapter 4). An example of the chart is shown in Figure B1.

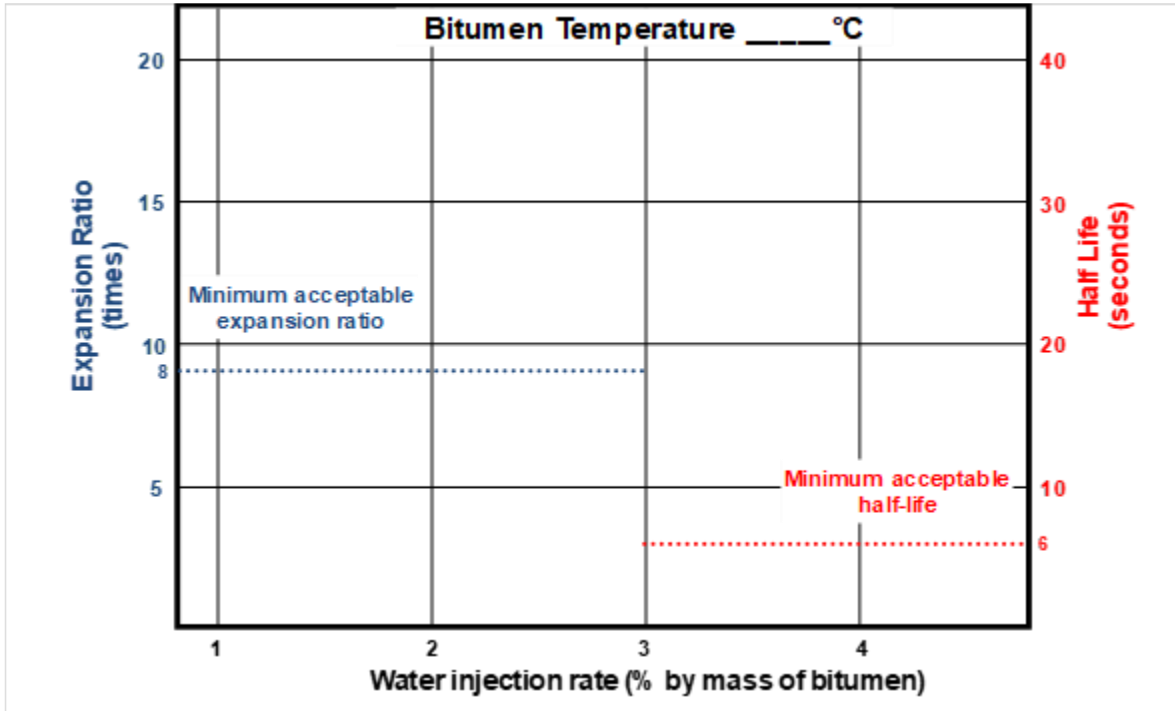

Figure B.1 Chart to Determine Optimum Water Injection Rate

10. TEST REPORT

Report the Optimum Water Injection Rate and the measured foam characteristics on a suitable form, including details of the bitumen being foamed. An example of such a form is shown below.

Influence of Water Injection Rate on the Expansion Ratio and Half-life									
Date					Bitumen type				
Tested by					Injection time		(sec)		
		Bitumen		Water		Air			
Temperature (°C)									
Pressure (bar)									
Water Injection		1 st measurement		2 nd measurement		3 rd measurement		Average	
Injection (%)	Flow (l/hr)	ER	$\tau_{1/2}$	ER	$\tau_{1/2}$	ER	$\tau_{1/2}$	ER	$\tau_{1/2}$
Flow rate		(g/sec)			As shown below		On / Off		

ANNEXURE A: Calculation Procedures

A.1 Calculate the Mass of Bitumen Discharged in 5 seconds (see Paragraph 9.1)

Use the information below to calculate the mass of bitumen discharged:

$$M_{bit} = (M_2 - M_1) = (696 - 194) = 502 \text{ g}$$

Where:

M_{bit} = mass of the bitumen discharged in 5 seconds

M_1 = mass of the 20 litre container (194 g)

M_2 = mass of the container and bitumen (696 g)

A.2 Determination of the Optimum Water Injection Rate

The following example explains how the graph is compiled from measurements of the foaming characteristics. Appropriate minimum acceptable values for the Expansion Ratio and Half-life are employed (explained in Chapter 4) to determine the Optimum Water Injection Rate for a specific bitumen temperature.

Assume that foamed bitumen is to be used as a stabilising agent on a project in a warm climatic region and the bitumen to be foamed is a standard 70/100 Pen Grade. Chapter 4 provides the minimum acceptable Expansion Ratio and Half-life values of 8 time and 6 seconds respectively.

The figures in the table below are typical measurements taken in the laboratory for three water injection rates with the bitumen at a temperature of 170 °C.

Table B.1 Influence of Water Injection Rate on the Expansion Ratio and Half-Life

Date	28/02/2019		Bitumen type		70 / 100 Pen grade				
Tested by	PvW		Injection time		5 (sec)				
	Bitumen		Water		Air				
Temperature (°C)	170		23		24				
Pressure (bar)	3		4		4				
Flow rate	100 (g/sec)		As shown below		On / Off				
Water Injection		1 st measurement		2 nd measurement		3 rd measurement		Average	
Injection (%)	Flow (l/hr)	ER	$\tau_{\frac{1}{2}}$	ER	$\tau_{\frac{1}{2}}$	ER	$\tau_{\frac{1}{2}}$	ER	$\tau_{\frac{1}{2}}$
2	7.2	12	26	10	22	8	25	10	24.5
3	10.5	12	11	15	12	16	15	14.5	12.5
4	14.4	18	3	16	5	17	4	17	4

The average values for Expansion Ratio and Half-life for each of the three water injection rates are then plotted on the graph, together with the minimum acceptable foaming characteristics.

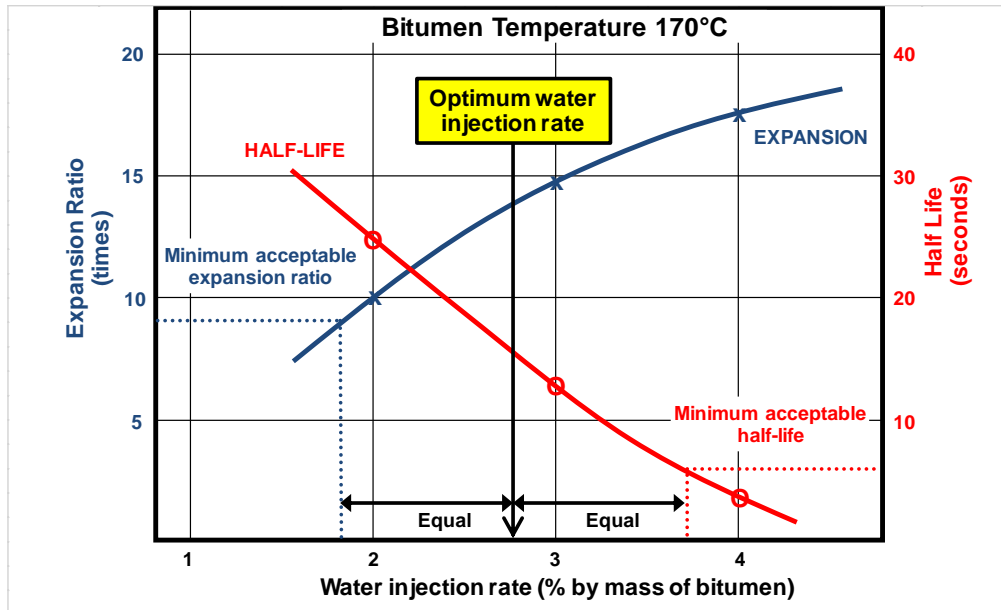

The Optimum Water Injection Rate is determined as follows:

- i. Determine the water injection rate for where the minimum acceptable Expansion Ratio and Half-life lines intersect the relevant curve:

- a) Water injection for minimum acceptable expansion: 1.9%
- b) Water injection for minimum acceptable half-life: 3.7%

- ii. The Optimum Water Injection Rate is the water injection rate that falls mid-way between the above two values:

The difference between the two minimum water injections rates:

$$3.7 - 1.9 = 1.8\%$$

Divide the difference in two:

$$1.8 \div 2 = 0.9\%$$

The Optimum Water Injection rate is:

$$1.9 + 0.9 = 2.8\%$$

RESULT: The Optimum Water Injection Rate for bitumen at 170 °C is 2.8% (by mass of the bitumen)

BSM2: LABORATORY MIX DESIGN OF BITUMEN STABILISED MATERIAL

1. SCOPE

This test method describes a mix design procedure for laboratory preparation, mixing, compacting, curing and testing of bitumen stabilised material using either foamed bitumen or bitumen emulsion.

2. REFERENCES

The following referenced documents are indispensable for the application of this method. All normative documents are subject to revision and, since any reference to a normative document is deemed to be a reference to the latest edition of that document. Parties to agreements based on this document are encouraged to take steps to ensure the use of the most recent editions of the normative documents indicated below. Information on currently valid national and international standards can be obtained from Standards South Africa.

- SANS 1649, Non-automatic self-indicating, semi-self-indicating and non-self-indicating weighing instruments with denominated verification scale intervals.
- SANS 3001-GR1, Civil engineering test methods Part GR1: Wet preparation and particle size analysis.
- SANS 3001-GR10, Civil engineering test methods Part GR2: Determination of the one-point liquid limit, plastic limit, plasticity index and linear shrinkage.
- SANS 3001-GR20, Civil engineering test methods Part GR20: Determination of the moisture content by oven-drying.
- SANS 3001-GR30, Civil engineering test methods Part GR30: Determination of the maximum dry density and optimum moisture content.
- TG2, Test Method BSM1, Determination of the foaming characteristics of bitumen.
- TG2, Test Method BSM3, Vibratory hammer compaction for test specimens of bitumen stabilised material.
- TG2, Test Method BSM4, Determination of the indirect tensile strength of bitumen stabilised material.
- TG2, Test Method BSM5, Determination of the shear properties of bitumen stabilised material (Triaxial test)
- TMH 5, Sampling methods for road construction materials.

3. DEFINITIONS

3.1 Bitumen stabilised material (BSM)

Granular, previously cement treated or reclaimed asphalt material blends, stabilised either using bitumen emulsion or foamed bitumen.

3.2 Foamed bitumen

Vaporizing cold water in hot bitumen to create foam.

3.3 Optimum fluid content (OFC)

The percentage (by mass) of the combination of bitumen emulsion and water required to achieve the maximum dry density (MDD) of material treated with bitumen emulsion.

3.4 Raw

Untreated material (gravel, crushed stone or reclaimed asphalt).

4. APPARATUS

4.1 Foamed bitumen laboratory unit

Capable of producing foamed bitumen at a consistent rate of between 50 g/sec and 200 g/sec, equipped with a thermostatically controlled kettle of capacity 10 kg of bitumen, operating at a constant temperature

± 5 °C within a range of 160 °C and 190 °C. The unit is to be equipped with an expansion chamber (similar to that used in full-scale production) into which water and hot bitumen is injected under pressure to create the foamed bitumen. The unit is to be capable of injecting compressed air and a set amount of water into the hot bitumen to produce a uniform foam. The amount of water added by mass is to be up to 5% of the mass of the bitumen and added at a controlled amount $\pm 0.25\%$. The unit shall be capable of producing a mass of foamed bitumen within 5 g of the prescribed amount, directly into a container or laboratory mixer. The unit is coupled directly to the pug mill mixer and is to inject the foamed bitumen directly into the running mixer uniformly across the full length of the mixer (between the two paddle shafts) by means of a fan jet fitted to the discharge end of the expansion chamber.

4.2 Pug mill mixer

Capacity 30 kg, with twin shafts and variable rotation speed control, graduated from a minimum to a maximum rotation speed of 150 rpm.

Note: Wirtgen WLB10S and WLM30 are examples of suitable foamed bitumen and pug mill units available commercially. This information is given for the convenience of users of this standard and does not constitute an endorsement of this product.

4.3 Steel tamper or small laboratory crusher

A small, laboratory-scale jaw crusher that is capable of resizing aggregates to minus 20 mm is recommended

4.4 Electronic balances

Fine measurement type complying with SANS 1649. One with a capacity of 15 kg reading to 5 g and one with a capacity of 2 kg reading to 0.1 g.

4.5 Suitable basin

About 500 mm diameter for mixing.

4.6 Containers

Mixing basin (or bath) 200 litres capacity.

Airtight containers of capacity:

- a) 20 litres for stabilised material.
- b) 1 litre for moisture content determination.

4.7 Sieves

Comply with SANS 3310-2, that comprise a 450 mm diameter sieve set with pan, which consists of sieves with nominal aperture sizes: 20 mm, 14 mm and 5 mm.

4.8 Litmus paper

5. PRINCIPLES

The mix design procedure requires step-wise and iterative ITS testing to select the most effective active filler and the optimum amount of bitumen stabilising agent, followed by triaxial testing to determine the shear properties of the treated material. At various stages the mix designer has to make selections based on the outcome of ITS tests, so that the next step can be carried out. The procedure is outlined in Table B.2.

Table B.2. Mix Design Procedure

Stage	Step	Action by	Description of Action Required
Preliminary	1	Laboratory	Carry out preliminary tests to determine the moisture content, grading and plasticity of the field sample.
	2	Designer Input	Approve material or specify material and blending proportions to adjust grading and plasticity.
	3	Designer Input	Select type of bitumen stabilising agent – foamed bitumen or bitumen emulsion.
	4	Laboratory	Proportion the material and reduce to minus 20 mm maximum size.
	5	Laboratory	Test the blended material to determine the MDD and OMC.
	6	Laboratory	Test the bitumen stabilising agent to determine its properties. Evaluate foamed bitumen characteristics or obtain bitumen emulsion certification.
Effect of active filler	7	Laboratory	Mix 3 samples with the same amount of bitumen; one with 1% lime, one with 1% cement and one with no active filler.
	8	Laboratory	Compact specimens, cure and ITS test to determine the wet and dry values.
	9	Designer Input	Select the type of active filler.
Optimum bitumen application rate	10	Laboratory	Mix 3 further samples with the active filler (step 8) and at 3 different bitumen application rates in 0.2% intervals either side of previous mix (step 6) i.e. 2 mixes lower + 1 higher
	11	Laboratory	Compact specimens, cure and ITS test to determine the wet and dry values.
	12	Designer Input	Select optimum bitumen application rate.
Triaxial test	13	Laboratory	Mix samples with the active filler (selected in step 8) and bitumen at the optimum application rate (selected in step 11).
	14	Laboratory	Compact specimens, cure and perform Triaxial testing to determine the shear properties.
Outcome	15	Laboratory	Report ITS and Triaxial results for the mix design.

6. PREPARATION OF SAMPLES AND PRELIMINARY TESTING

6.1 General

During the preparation procedure, input from the BSM mix designer is required to specify approval or modification of the raw material (by blending) and the type of bitumen stabilising agent to be used. The preparation procedure is dependent on whether bitumen emulsion or foamed bitumen is to be used as the bituminous stabilising agent. The paragraphs dealing with the other stabilising agent should be ignored and the specified design inputs should be clearly indicated on the test report.

Sample the field material to be stabilised in accordance with TMH5. A large sample of at least 500 kg for each mix design is recommended. This quantity enables preliminary testing to be carried out and for fractions of material to be discarded during the preparation stage.

6.2 Test sample sizes

The size of the test samples will depend on the extent of the testing programme envisaged. Table B.3 provides a guideline for the quantity of air-dried material that will be required to manufacture test specimens for a normal BSM design.

Table B.3 Guideline for Sample Size Requirements for BSM Mix Design

Testing Phase	Specimen size (mm)	Number of specimens	Maximum mass of each specimen (kg)	Number of mixes (kg /mix)	Total mass required (kg)
Preliminary tests	-	-	-	-	100
Effect of active filler	150 ϕ x 95	6 x 3 = 18	4.5	3 (26) *	60
Optimum bitumen application rate	150 ϕ x 95	6 x 3 = 18	4.5	3 (26) *	60
Shear properties	150 ϕ x 300	10	15	5 (30)	150
Allowance for repeat testing	-	-	-	-	80
				<u>Total</u>	<u>450</u>

Note: * 20 kg is the minimum mass for effective mixing in a pug mill mixer

6.3 Preliminary tests

- 6.3.1 Mix the field sample and take out a representative sample for preliminary testing.
- 6.3.2 Carry out the moisture content, grading analysis and Atterberg Limits tests as listed in Table B.4, on representative specimens taken from the preliminary testing sample.

Table B.4 List of Preliminary Tests

Test	Standard
Determination of the moisture content (W_M)	SANS 3001-GR20
Grading analysis (Wet preparation and particle size analysis)	SANS 3001-GR1
Atterberg Limits (Determination of the one-point liquid limit, plastic limit, plasticity index and linear shrinkage)	SANS 3001-GR10
Determination of maximum dry density and optimum moisture (or fluid) content *	SANS 3001-GR30 or Annexure A *

Note: * depending on the type of stabilising agent used (foamed bitumen or bitumen emulsion)

- 6.3.3 Report the results of the tests carried out in 6.3.2 to the mix designer and obtain instructions as to the type of bitumen stabilising agent to be used (foamed bitumen or bitumen emulsion), whether the raw material is suitable or requires blending and, if so, the type of material to be added and the proportions.
- 6.3.4 Depending on the instructions in 6.3.3, carry out the material blending specified or use the raw material as is, and test the material for maximum dry density and optimum moisture or fluid content (see Table B.4). When the raw material has been modified by blending additional material, carry out a further grading analysis as described in Table B.5.
- 6.3.5 Depending on the type of bitumen stabilising agent to be used (see 6.3.3) either determine the foaming characteristics of the bitumen as described in Test Method BSM1 or test the emulsion as described in 6.3.6.
Note: Bitumen of minimum 70 Pen is required to ensure that the bitumen is suitable for foaming.
- 6.3.6 When bitumen emulsion is specified, check the manufacturer's certificate for type, bitumen content and date of manufacture of the emulsion. Only stable grade emulsion is suitable for bitumen stabilisation. Where such certification is not available, carry out the following tests:
 - 6.3.6.1 Check the charge on the bitumen emulsion using a strip of litmus paper. When the paper turns red the emulsion is cationic (with a pH < 7). When the paper turns blue the emulsion is anionic (with a pH > 7).
 - 6.3.6.2 Check the stability of the emulsion by adding approximately 83 g of emulsion to a cement paste (i.e. 50 g of ordinary Portland cement + 17 g water premixed with a spatula) and mix in a tin by stirring vigorously with a spatula. The outcomes are evaluated as follows:

- If the mix remains smooth after 60 seconds of mixing, then you have a Slow Set (Stable Grade) emulsion
 - If the mix breaks and coagulates quickly (<20 secs of mixing) you have a Rapid Set (Spray Grade) emulsion
 - Intermediate break time and some coagulation would most likely indicate a Medium Set (Premix Grade) emulsion
- 6.3.6.3 Check the compatibility of the emulsion with the proposed mixing water by adding 50 millilitres of water to 50 millilitres of emulsion and gently turning the cylinder upside-down several times whilst sealing the top by hand. Allow the fluid mixture to stand for 30 minutes. If any bitumen separation or coarsening of the fluid is observed there is a compatibility problem and another source of water should be used.

6.4 Sample Proportioning

6.4.1 From the grading analysis determined in Paragraphs 6.3.2 or 6.3.4, calculate the proportions retained, expressed as a percentage of the total sample, as follows:

A = percentage retained on the 20 mm sieve

B = percentage retained on the 14 mm sieve

C = percentage retained on the 5 mm sieve

D = percentage passing the 5 mm sieve

6.4.2 Air-dry the field sample sufficiently so that the material can be sieved into separate fractions.

6.4.3 Sieve the sample through the 20 mm, 14 mm and 5 mm sieves, in order of decreasing size, into a pan.

6.4.4 Crush lightly the material retained on the 20 mm sieve so that it just passes the 20 mm sieve. Sieve the crushed material through the 14 mm sieve and add the material retained to the minus 20 mm plus 14 mm fraction. Discard the fraction passing the 14 mm sieve that was generated by crushing.

6.4.5 Using the proportions given in Table B.5 reconstitute the fractions (see 6.4.4) to provide samples for ITS and Triaxial tests, and store in sealed containers. An example of the procedure is given in Annexure B.

Note: This procedure allows for different sizes of samples to be produced with a similar grading

Table B.5 Representative Proportions by Mass to be used for Test Sample Preparation

Fraction	Percentage of Total Mass
< 20 mm to ≥ 14 mm	A + B
< 14 mm to ≥ 5 mm	C
< 5 mm	D

7. MIX DESIGN

7.1 General

The following paragraphs describe the iterative mix design procedure to determine the active filler type and the optimum bitumen application rate.

Note: The residual bitumen content for emulsion is assumed to be 60% in the following sections.

Table B.6 Guidelines for Estimating Optimum Bitumen Addition

Fraction < 0.075mm (%)	Bitumen addition (% m/m dry aggregate)		Typical Material
	Fraction < 4.75mm		
	< 50%	> 50%	
< 4	1.8	2.0	Recycled asphalt (RA)
4 – 7	2.1	2.3	RA Graded Crushed Stone Natural Gravel Blends
7 – 10	2.4	2.6	
> 10	2.6	2.9	Gravels Sands

7.2 Active filler selection

- 7.2.1 Mix the bulk sample prepared in Paragraph 6.4.5 and riffle out sufficient material for 3 batches of ITS tests (about 78 kg, see Table B.3).
- 7.2.2 Use Table B.6 to select an estimated optimum (residual) bitumen content for either foamed bitumen or emulsion. For example, the grading yields 55% < 4.75 mm and 6% < 0.075 mm, so 2.3% of bitumen addition is required. Mix each batch of material: one without active filler, one with 1% cement and one with 1% lime.
- 7.2.3 Because pug mill mixers require a minimum mass for effective mixing, mix each of the three batches using the minimum mass of material recommended by the manufacturer of the pug mill (26 kg for the Wirtgen WLM 30).
 - 7.2.3.1 Measure out 26 kg from the bulk sample material, place in the pug mill mixer and spread uniformly along the length of the mixer.
 - 7.2.3.2 Measure out the required amount of active filler as calculated in Paragraph 9.1.2. Sprinkle the active filler uniformly on top of the spread sample material. Close the lid of the mixer and mix for 30 seconds with the pug mill set at the medium rotation speed. Stop the mixer and leave it to stand for at least 2 minutes to allow the dust to settle.
 - 7.2.3.3 Following the procedure described in Paragraphs 8.2 (bitumen emulsion) or 8.3 (foamed bitumen), add and mix the required amount of water and bitumen stabilising agent to the material in the mixer.
 - 7.2.3.4 Measure the temperature of the material to the nearest 1 °C.
- 7.2.4 Compact, cure and ITS test the specimens (3 dry and 3 soaked per batch) as described in Test Methods BSM3 and BSM4.
- 7.2.5 Report the ITS values to the mix designer and obtain instructions regarding the type of active filler to be used. In special circumstances, the mix designer may require an active filler content other than 1%.

7.3 Optimum bitumen application rate

- 7.3.1 As described in 7.2.1, prepare sufficient material for 3 batches of ITS tests (about 78 kg, see Table B.3).
- 7.3.2 As described in 7.2.3, mix the required amount and type of active filler specified by the mix designer (see 7.2.5) to the sample.
- 7.3.3 As described in 8.2 or 8.3, prepare and mix each of the three batches with the bitumen application rate recommended in Table B.6. With experience, and depending on the ITS values obtained in 7.2, other ranges of bitumen application rates may be used. However, small increments i.e. less than 0.2%, are not recommended.

Note: The intention of Table B.6 is to bracket the optimum bitumen application rate. In the case where the raw material is of high quality, such as reclaimed asphalt and crushed stone base, the application rates may all be reduced to below the 2.3% used to determine the effect of active filler (Paragraph 7.2).

Table B.7 Selection of Bitumen Application Rates

Bitumen Stabilising Agent type	Bitumen Application Rate per Batch			
	Batch 1	Batch 2	Already tested	Batch 3
Emulsion	3.2% (1.9% RBC)	3.5% (2.1% RBC)	3.8% (2.3% RBC)	4.2% (2.5% RBC)
Foam	1.9% BC	2.1%	2.3%	2.5%
BC = Bitumen content. RBC = Residual bitumen content. Active Filler for all batches determined in Section 7.2.				

- 7.3.4 Compact, cure and ITS test the specimens manufactured from each batch (3 dry and 3 soaked) as described in Test Methods BSM3 and BSM4.
- 7.3.5 Plot and report the ITS_{DRY} and ITS_{WET} values against the respective bitumen application rate (including the values obtained in 7.2.6 for determining the effect of active filler) to the mix designer and obtain instructions regarding the optimum bitumen application rate to be used.

7.4 Triaxial test specimens

- 7.4.1 Mix the bulk sample prepared in 6.4.5 and riffle out sufficient material for 5 batches required for triaxial testing (about 150 kg, see Table B.3).
- 7.4.2 Mix the required bitumen application rate and type of active filler specified by the mix designer (see 7.2.5) into each of the batches.
- 7.4.3 Transfer the mixed material from each batch into a suitable container and cover with a moist hessian cloth to prevent moisture loss.
- 7.4.4 Thoroughly mix the material in the container before compacting, curing and testing the specimens, as described in Test Methods BSM3 and BSM5.

8. MIXING

8.1 General

Because pug mill mixers require sufficient material to be placed in the mixer for effective mixing, it is recommended that not less than 20 kg is used for any one mix or batch. The mixing procedure described assumes that the mixing operation will be followed directly by compaction, curing and testing of each set of specimens. Depending on the capabilities of the laboratory carrying out the testing this approach may be varied, providing that during any pauses permitted in the procedure, the material is stored in clearly marked air-tight containers. The type of bitumen stabilising agent is specified by the **mix designer** in Paragraph 6.3.3. Ignore references to the other bitumen stabilising agent in the following paragraphs.

8.2 Bitumen emulsion stabilisation

- 8.2.1 Spread out the material in the pug mill mixer uniformly along the length of the mixer.
Note: The raw material was measured out and the active filler mixed in as described in Section 7.2.3, 7.3.2 and 7.4.2.
- 8.2.2 Ensure that the temperature of the mixing water is $25\text{ }^{\circ}\text{C} \pm 1.5\text{ }^{\circ}\text{C}$. Measure out the amount of water that needs to be added (V_w) to achieve the required OFC (see 9.1.4 for calculations and Annexure A for OFC determination).
- 8.2.3 Add the water to the material by sprinkling uniformly over the surface of the material in the mixer. Mix for 30 seconds at the maximum speed of rotation.
- 8.2.4 Ensure that the temperature of the bitumen emulsion is $60\text{ }^{\circ}\text{C} \pm 2.0\text{ }^{\circ}\text{C}$. Where no heating mechanism is available discretion may be exercised to mix at $25\text{ }^{\circ}\text{C}$ (minimum). Measure out the required amount of bitumen emulsion that needs to be added (see 9.1.2 for calculation). Care should be taken to clearly differentiate between the amount of emulsion and the amount of bitumen in the emulsion. Emulsion of the same type and bitumen content must be used throughout the procedure. To avoid confusion, check that calculations show correctly the amounts of water and emulsion.
Note: For example, 2% SS60 emulsion contains 1.2 % residual bitumen.

- 8.2.5 Remove the cover of the mixer and add the bitumen emulsion to the material by sprinkling uniformly over the surface of the material in the mixer. Mix for 30 seconds at the maximum speed of rotation i.e. 144 rpm.
- 8.2.6 Remove the sample from the mixer, measure the temperature of the mixed material to the nearest 1 °C and place in a marked sealed container.
Note: The aggregate temperature should be measured before and after mixing.
- 8.2.7 Manufacture the test specimens within 30 minutes of mixing, as described in Test Method BSM3.

8.3 Foamed bitumen stabilisation

- 8.3.1 Spread out the material in the pug mill mixer uniformly along the length of the mixer.
Note: The raw material was measured out and the active filler mixed in as described in Paragraphs 7.2.3, 7.3.2 and 7.4.2.
- 8.3.2 Ensure that the temperature of the mixing water is 25 ± 1.5 °C. Measure out the amount of water that needs to be added to achieve 60% to 75% of OMC, where coarser materials require a lower percentage of OMC (see Paragraph 9.1.4 for calculation).
- 8.3.3 Add the water to the material in the pug mill mixer by sprinkling uniformly over the surface of the material in the mixer. Mix for 30 seconds at the maximum speed of rotation.
- 8.3.4 Couple the foamed bitumen laboratory unit to the mixer. Set the foamed bitumen laboratory unit to add air, bitumen and water at the prescribed rates to manufacture the foam. Add the required quantity of foamed bitumen (see 9.1.2) whilst the mixer is running. Continue to mix for a further 30 seconds at the maximum speed of rotation.
- 8.3.5 Remove the cover of the mixer and add additional water to bring the moisture content to 100% of OMC. Sprinkle the water uniformly over the surface of the material in the mixer. Mix for 30 seconds at the maximum speed of rotation.
- 8.3.6 Remove the sample material from the mixer, measure the temperature of the mixed material to the nearest 1 °C and place in a marked sealed container.
- 8.3.7 Manufacture the test specimens within 30 minutes of mixing, as described in Test Method BSM3.

9. CALCULATIONS

Note: An example of the calculation procedure is given in Annexure C.

9.1 Calculations required in the procedure

- 9.1.1 Calculate the air-dried mass of material to the nearest gram, used in the mix using the following equation.

$$M_D = \frac{M_{AD}}{1 + \frac{W_M}{100}}$$

Where:

M_D oven-dried mass of material to be mixed, in grams (g)

M_{AD} air-dried mass of material to be mixed, in grams (g)

W_M moisture content of the air-dried material, as determined in SANS 3001-GR20, as a percentage of the oven-dried mass

- 9.1.2 Calculate the quantity of required active filler or bitumen stabilising agent to be added to the nearest gram, using the following equation.

$$M_{Ai} = P_A \times \frac{M_D}{100}$$

Where:

M_{Ai} mass of active filler or bitumen stabilising agent to be added, in grams (g)

P_{Ai} specified percentage of active filler or bitumen stabilising agent to be added (%)

M_D mass of oven-dry material to be mixed, in grams (g)

i either F for filler or S for bitumen stabilising agent

- 9.1.3 Calculate the quantity of water to the nearest millilitre, to be added to achieve the OFC when stabilising with bitumen emulsion using the following equations:

$$M_W = \frac{\text{OFC} \times (M_D + M_{AF})}{100} - (M_{AD} - M_D) - M_{AS}$$

Where:

- M_W mass of water to be added, expressed in millilitres (ml)
 OFC optimum fluid content, expressed as a percentage (%)
 M_{AF} mass of active filler to be added, expressed in grams (g)
 M_{AS} mass of bitumen stabilising agent to be added, expressed in grams (g)
 M_{AD} mass of air-dried material to be mixed, expressed in grams (g)
 $M_W \approx V_W$ based on the assumption that the density of water is approximately 1 kg/l
 V_W volume of water to be added, expressed in millilitres (ml)

- 9.1.4 Calculate the quantity of water to the nearest millilitre, to be added to achieve the OMC when stabilising with foamed bitumen, using the following equation.

$$M_W = \frac{\text{OMC} \times (M_D + M_{AE})}{100} - (M_{AD} - M_D)$$

Where:

- OMC optimum moisture content of the material to be stabilised, as a percentage (%) (See Paragraph 8.3.2)
 $M_W \approx V_W$ based on the assumption that the density of water is approximately 1 kg/l

Note: 75% of the total moisture mass is added before foaming and mixing. The remaining 25% is added after foaming (see Paragraphs 8.3.2 and 8.3.5).

10. TEST REPORT

Report the following where appropriate on a suitable form:

- a) Type and percentage of active filler and bitumen application rate required.
- b) Initial moisture content of field sample.
- c) Preliminary test results:
 - i) Particle size analysis
 - ii) Liquid limit, plastic limit and plasticity index
 - iii) MDD and OMC (or OFC) before mixing
- d) Bitumen stabilising agent:
 - i) Bitumen emulsion: Source, type, bitumen content, stability and date of manufacture.
 - ii) Foamed bitumen: Foaming characteristics determined in Appendix B, Test Method BSM1: *Determining the Foaming Characteristics of Bitumen.*
- e) For each batch mixed:
 - iii) Date and time of mixing
 - iv) Mass of material mixed
 - v) Moisture content after air-drying
 - vi) Material temperature immediately before and after mixing
 - vii) Percentage active filler and bitumen application rate

ANNEXURE A: Determination of the Maximum Dry Density (MDD) and Optimum Fluid Content (OFC) of a Material Treated with Bitumen Emulsion

A.1 Scope

The Optimum Fluid Content (OFC) of a bitumen emulsion stabilised material is the percentage (by mass) of the combination of bitumen emulsion and water required to achieve the maximum dry density (MDD) of the treated material. The MDD and OFC are determined following the same procedure for determining the MDD and optimum moisture content (OMC) of a material, substituting diluted bitumen emulsion for water to achieve the different moisture (fluid) contents.

A.2 Apparatus

This procedure uses the same apparatus as that used to determine the MDD and OMC of the material as described in SANS 3001-GR30. In addition, a 1 000 millilitre measuring cylinder is required.

A.3 Procedure

Follow the same procedure for determining the MDD and OMC as described in SANS 3001-GR30. In the place of water, a fluid consisting of a 50:50 blend of bitumen emulsion and water is used. Add and mix in the prescribed type and amount of active filler to the material to be tested.

To prepare the fluid pour 500 ml of the bitumen emulsion into a 1 000 ml measuring cylinder. Ensure that the bitumen emulsion is the same as that to be used for the bitumen stabilisation mix design. Slowly add 100 ml of clean water. Mix the bitumen emulsion with the water by gently turning the cylinder upside-down several times whilst sealing the top by hand. Continue diluting the bitumen emulsion in this manner by adding further units of 100 ml water until a 1 000 ml of blended fluid is achieved.

Using this diluted bitumen emulsion fluid, measure out the amount required for each specimen sample required in the SANS 3001-GR30 procedure.

ANNEXURE B: Sample Proportioning Procedure (see Paragraph 6.4)

B.1 Grading

The grading of the sample is shown in the table below.

Table B.8 Grading

Sieve Size (mm)	Passing (%)	Retained	
		Percent (%)	Portion
20	85	15	A
14	60	25	B
5	12	48	C
Pan	-	12	D

B.2 Crushing and proportioning

A 450 kg sample is sieved through a 20 mm, 14 mm and 5 mm sieve into a pan. The material retained on the 20 mm sieve is lightly crushed to just pass the 20 mm sieve and then added to the minus 20 mm plus 14 mm fraction. The table below gives an example of the proportioning of the sample to obtain a total mass of 80 kg (enough material for three sets of ITS tests).

Table B.9. Sample Proportioning

1	2	3	4	5	6	7
Sample		Fraction mass after crushing (kg)	Amended fractions		80 kg sample	
Fraction (mm)	Portion		Amended portions as per Table B.8	Percentage of whole sample ² %	Proportioning calculation	Masses required kg
> 20	A ¹	-	-	-	-	-
< 20 to ≥ 14	B	177,5	A + B	15 + 25 = 40	$80 \times \frac{40}{100}$	32
< 14 to ≥ 5	C	218	C	48	$80 \times \frac{48}{100}$	38,4
< 5	D	54,5	D	12	$80 \times \frac{12}{100}$	9,6
TOTAL		450				80

1 Material lightly crushed to just pass 20 mm sieve.

2 From Table B.8, Column 3 (Percent Retained).

ANNEXURE C: Calculation Procedures

C.1 General

Use the following information to calculate C.2 to C.3:

$$M_{AD} = 29\,561 \text{ g}$$

$$W_M = 2.2\%$$

$$P_{AF} = 1.0\%$$

$$P_{AS} = 3.5\% \text{ emulsion}$$

$$OMC = 6.3\%$$

C.2 Calculate the air-dried mass of material used in the mix (see paragraph 9.1.1)

$$M_D = \frac{M_{AD}}{1 + \frac{W_M}{100}} = \frac{29\,561}{1 + \frac{2.2}{100}} = 28\,925 \text{ g}$$

C.3 Calculate the quantity of required active filler and bitumen stabilising agent to be added (paragraph 9.1.2)

$$M_{AF} = P_{AF} \times \frac{M_D}{100} = 1.0 \times \frac{28\,925}{100} = 289 \text{ g}$$

and

$$M_{AS} = P_{AS} \times \frac{M_D}{100} = 3.5 \times \frac{28\,925}{100} = 1\,012 \text{ g}$$

C.4 Calculate the quantity of water to be added to achieve the OFC (paragraph 9.1.3)

$$M_W = \frac{OFC \times (M_D + M_{AF})}{100} - (M_{AD} - M_D) - M_{AS}$$

$$M_W = \frac{6.3 \times (28\,925 + 289)}{100} - (29\,561 - 28\,925) - 1\,012$$

$$M_W = 1840.428 - 636 - 1012 = 192 \text{ g} \approx 192 \text{ ml}$$

Note: OFC is determined through a sensitivity analysis of MDD versus moisture content at typical binder content. OFC is no longer automatically equated with OMC.

BSM3: VIBRATORY HAMMER COMPACTION OF TEST SPECIMENS OF BITUMEN STABILISED MATERIAL

1. SCOPE

This test method describes the preparation and compaction of test specimens of bitumen stabilised material (BSM) using a vibratory hammer.

2. REFERENCES

The following referenced documents are indispensable for the application of this document. For dated references, only the edition cited applies. For undated references, the latest edition of the referenced document (including any amendments) applies. Information on currently valid national and international standards can be obtained from the SABS Standards Division.

- SANS 1649, Non-automatic self-indicating, semi-self-indicating and non-self-indicating weighing instruments with denominated verification scale intervals.
- SANS 3001-GR10, Civil engineering test methods Part GR2: Determination of the one-point liquid limit, plastic limit, plasticity index and linear shrinkage.
- SANS 3001-GR20, Civil engineering test methods Part GR20: Determination of the moisture content by oven-drying.
- SANS 3001-GR30, Civil engineering test methods Part GR30: Determination of the maximum dry density and optimum moisture content.
- TG2, Test Method BSM1, Determination of the foaming characteristics of bitumen.
- TG2, Test Method BSM2, Laboratory Mix Design of Bitumen Stabilised Materials.
- TG2, Test Method BSM4, Determination of the indirect tensile strength of bitumen stabilised material.
- TG2, Test Method BSM5, Determination of the shear properties of bitumen stabilised material (Triaxial test)
- TMH 5, Sampling methods for road construction materials. Pretoria.

3. DEFINITIONS

For the purpose of this document, the following definitions apply:

3.1 Bitumen Stabilised Material (BSM)

Granular, previously cement treated or reclaimed asphalt material blends, stabilised either using bitumen emulsion or foamed bitumen.

3.2 Indirect Tensile Strength (ITS)

The stress at failure generated by the load required to split a cylindrical specimen of bitumen stabilised material.

3.3 Maximum dry density (MDD)

The maximum dry density of the material determined from the peak of the dry density versus moisture content curve obtained as described in SANS 3001-GR30.

3.4 Optimum moisture content (OMC)

The moisture content at which the maximum dry density is achieved.

4. APPARATUS

4.1 Vibratory demolition hammer

Of mass 11.5 ± 0.1 kg with rated power input of 1700 W, an impact rate of 900 to 1 700 beats per minute and impact energy of $23 \text{ J} \pm 1 \text{ J}$ per stroke.

Warning: Prolonged exposure to the noise emitted by a demolition hammer can lead to impaired hearing. The operator should always wear ear plugs and, to protect others in the vicinity, the vibratory hammer compaction unit should be housed in a soundproof cabinet. Working beneath the suspended hammer assembly has the potential of causing bodily harm in the event of the locking device malfunctioning. Such locking device requires regular inspection and maintenance to ensure its functionality. In addition, exercise care when lowering the tamping foot into the mould to prevent damaging fingers or hands.

Note: A Bosch Demolition Hammer, GSH 11VC Professional, is an example of a suitable product available commercially. This information is given for the convenience of the users of this standard and does not constitute an endorsement of this product.

4.2 Compaction shank

With corrosion resistant steel, with a tamping foot of diameter 145 ± 1 mm, of combined mass 3.0 ± 0.1 kg (see Figure B.2). The shank is machined with an SDS Max fitting to enable it to be fitted into the demolition hammer.

4.3 Compaction block

Concrete with a strength of approximately 25 MPa, that is at least 1 m x 1 m and 300 mm thick, reinforced with 2 layers of steel mesh (Ref 395), one placed 50 mm from the top of the block, the other 50 mm from the bottom. The surface of the block is cast level. The block has attachments such that the mould base plate can be securely and uniformly fixed to the block.

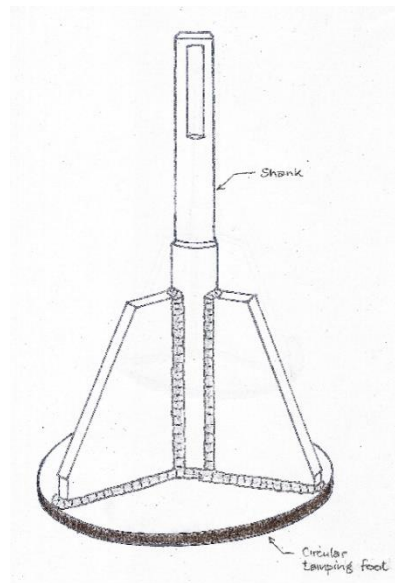

Figure B.2 Compaction Shank

4.4 Frame

With vertical slides, complete with mounting head for the vibratory hammer, that allows the vibratory hammer to be suspended above the mould with the tamping foot centred on the mould. The slides are to ensure free downward movement of the hammer as it compacts the material in the mould. The frame is fitted with a system (connected to the top of the frame) for lifting and lowering the vibratory hammer. The base of the frame is bolted to the compaction block.

- 4.5 Surcharge weight
Metal, attached to the vibratory hammer mount to achieve a total suspended mass of 33 ± 0.5 kg (including the compaction shank and foot).
Note: A Wirtgen WLV1 frame, is an example of a suitable product available commercially. This information is given for the convenience of the users of this standard and does not constitute an endorsement of this product.
- 4.6 Split cylindrical moulds
Corrosion-resistant steel, with two segments:
a) With inside diameter 152 ± 0.5 mm and height of at least 120 mm; and base plate, for ITS test specimens
b) With inside diameter 150 ± 0.5 mm and height of at least 320 mm; and base plate, for triaxial test specimens.
Note: The base plate that fits the 152 mm diameter mould may be used for the 150 mm diameter mould.
- 4.7 Interlayer roughening device (IRD)
Diameter 145 ± 1.0 mm, fitted with protruding teeth of length 12 ± 2.0 mm for roughening the upper surface of each compacted layer.
- 4.8 Carrier plates
Plywood of thickness approximately 15 mm and diameter approximately 160 mm, one for each compacted specimen.
- 4.9 Electronic balances
Fine measurement type that comply with SANS 1649:
a) With a capacity of at least 30 kg, and that reads to 1 g.
b) With a capacity of at least 10 kg, and that reads to 0.1 g.
- 4.10 Drying oven
Capable of maintaining a temperature range of 105 °C to 110 °C with continuous draft.
- 4.11 Containers
With lids that retain moisture, of capacity of at least
a) 2.5 litres for moisture content samples.
b) 20 litres for the mixed treated material.
- 4.12 Suitable basins
One of diameter approximately 300 mm, one of diameter at least 500 mm and one with a capacity of 200 litres.
- 4.13 Scoop
Of capacity approximately 500 millilitres.
- 4.14 Trowel, garden type
- 4.15 Timer
Capable of reading up to 5 minutes and reading to 1 second.
- 4.16 Vernier callipers
Measuring to 350 ± 1 mm.
- 4.17 Spatula
With steel blade, of length approximately 350 mm.

- 4.18 Marking materials consisting of
- a) Marker pen
 - b) Oil based white paint for marking compacted specimens
 - c) Thin artist's brush

5. PREPARATION OF THE TEST SPECIMENS

5.1 Sample preparation

5.1.1 Preparation of BSM samples mixed in the laboratory as described in TG2 Test Method BSM2.

Note: The procedure in TG2 Test Method BSM2 requires the mix designer to specify the percentages by mass of active filler and stabilizing agent to be added; and the type of bituminous stabilizing agent.

5.1.2 Preparation of samples from field mixed BSM.

5.1.2.1 Sample the BSM in the field as described in TMH 5.

5.1.2.2 Obtain the maximum dry density (MDD) and optimum moisture content (OMC) from routine field control testing.

5.2 Determination of sample size

Use the data from Table B.10 and the formula in 7.1.2 to determine the amount of BSM required to prepare the test specimens.

Table B.10. Specimen Requirements

Requirements	ITS test	Triaxial test
Number of specimens per set	6	10
Mass of BSM required per set (kg)	26	150
Specimen height (mm)	95	300
Number of layers	2 ¹	5 ²
Layer thickness (mm)	47,5	60

Notes:

1. *May be increased to 3 layers in exceptional circumstances where de-bonding between layers occurs.*
2. *If the required density cannot be achieved in any layer after compacting for 120 seconds with the vibratory hammer, stop compaction and increase the number of thinner layers to achieve the same overall height (e.g. increase the number of layers to 6, each 50mm thick).*

6. PROCEDURE

6.1 Equipment preparation

Ensure that the vibratory hammer frame is securely attached to the concrete support block and is installed vertically. Install the vibratory hammer and surcharge weight into the mounting frame and insert the tamping foot. Using the lifting system, raise and lower the hammer to ensure that there is no resistance to sliding.

Clean the mould and base plate. Lubricate the inside of the mould with a light application of lubricating grease or non-stick spray. Fix the mould and base plate to the concrete block. Check the alignment of the mould and vibratory hammer by lowering the tamping foot into the mould. Check that the lifting system provides sufficient slack for the tamping foot to rest on the base plate.

6.2 Compaction

6.2.1 Lower the vibratory hammer so that the tamping footrests on the base plate. Using a marking pen, mark the location of the slide on the frame. Raise the vibratory hammer using the lifting system and secure it at least 500 mm above the mould. Using a steel ruler, measure upwards from the mark on the frame and accurately mark the distance to the top of the first compacted layer (47.5 mm for ITS specimens and 60 mm for triaxial specimens); and subsequent layers (95 mm for ITS specimens; 120 mm, 180 mm, 240 mm, 300 mm for triaxial specimens).

When the vibratory hammer frame is fitted with an electronic system for controlling the compacted thickness of the layers, carefully follow the set up and operating procedures specified by the manufacturer.

6.2.2 Determine the mass of BSM required for each layer using the formula in 7.1.3.

6.2.3 From the sample prepared in the laboratory (see 5.1.1) or from the field mixed sample (see 5.1.2) measure out the mass of the BSM required for the first layer (accurate to ± 1 g) and carefully pour it into the mould without any spillage. Use the spatula to spread the material evenly in the mould avoiding segregation. Then use the Interlayer Roughening Device (IRD) to level the material inside the mould. Failure to level the material can cause the tamping foot to break due to eccentric loading. Retain the remainder of the sample in the sealed container to prevent moisture loss.

6.2.4 Lower the vibratory hammer until the tamping foot rests on the material. Ensure that the lifting system is slack, allowing the hammer to slide downwards as the material compacts. Turn on the vibratory hammer and start the timer. Allow the hammer to run until the mark on the sliding frame for the first layer is reached. Immediately turn the hammer off and stop the timer. Record the time taken to compact the layer. Raise the hammer using the lifting system and secure it at least 500 mm above the mould.

When the compaction time for any layer exceeds 120 seconds, terminate the manufacturing procedure, increase the number of layers and start the procedure again from Paragraph 6.2.1. In the unlikely event of the problem persisting with an increased number of layers, terminate the manufacturing procedure and seal all the material in airtight containers. Repeat the moisture / density relationship test on a new sample of the untreated material to determine the correct values for the MDD and OMC (see 5.1.1 or 5.1.2). Then start the procedure again using the revised MDD as the target density.

6.2.5 Prepare the surface of the compacted layer inside the mould using the interlayer roughening device (IRD). Place the IRD on top of the compacted material and apply sufficient pressure so that the teeth fully penetrate into the material. Maintaining the applied pressure, turn the IRD through 90° and then back again at least four times to loosen the material at the top of the layer. Lift the IRD out of the mould and inspect the roughened surface. If the material is not visibly loose, repeat the procedure described above as many times as necessary. When the surface has been sufficiently roughened, proceed immediately with the next layer.

6.2.6 Compact the second and any subsequent layers as described in 6.2.1 to 6.2.5. All layers are to be compacted in a continuous operation.

6.2.7 After the treated material has been placed in the mould for the second layer, transfer 500g to 1,000g of the remaining material in a suitable container for moisture content determination as described in SANS 3001-GR20.

6.2.8 After compaction is complete, remove the mould from the base plate, carefully place the mould and specimen on the carrying plate and following the handling and curing instructions in TG2 Test Method BSM4 (for ITS specimens) or TG2 Test Method BSM5 (triaxial specimens).

7. CALCULATIONS

Note: An example of the calculation procedure is given in Annexure A.

7.1 Calculations required in the procedure

7.1.1 Determine the mass of each BSM specimen at OMC to the nearest gram, using the following equation:

$$M_S = \frac{(\pi \times d^2)}{4 \times 10^6} \times h \times \left(MDD \times \left(1 + \frac{OMC}{100} \right) \right)$$

Where:

M_S mass of BSM specimen at OMC, expressed in grams (g)

d diameter of the specimen, in millimetres (mm)

h height of the specimen, in millimetres (mm)

MDD MDD, in kilograms per cubic metre (kg/m³)

OMC OMC, as a percentage (%)

7.1.2 Determine the total mass of BSM required for manufacturing a batch of specimens to the first decimal place, using the following equation:

$$M_B = \frac{(N_S \times M_S)}{1000} + 4$$

Where:

M_B mass of BSM required to manufacture a batch of specimens, in kilograms (kg)

M_S number of specimens to be manufactured (see Table B.10)

7.1.3 Determine the mass of material required per compaction layer (of equal thickness) to the nearest gram, using the following equation:

$$M_L = \frac{M_S}{n}$$

Where:

M_L is the mass of material in each layer, in grams (g)

n is the number of layers (of equal thickness) to be compacted (see Table B.10)

8. TEST REPORT

Report the MDD to the nearest kg/m³ and the OMC and moulding moisture content to the nearest 0.1%.

The test report shall include the following general information:

- a) Mould diameter
- b) Details of aggregate and binder used in the mix including mix proportions
- c) Date of manufacture

And for each specimen:

- a) Identification marking
- b) Number of layers and compaction time for each layer to the nearest 1 second

ANNEXURE A: Calculation Procedure

A.1 Use the following information given in Table B.11 to calculate A.2, A.3, and A.4.

Table B.11 Data for Example Calculations

1	2	3
Property	ITS test	Triaxial test
d (mm)	152	150
h (mm)	95	300
MDD (kg/m ³)	2 145	
OMC (%)	5,6	
NS	6	10
N	2	5

A.2 Calculate the mass of each specimen at the OMC (see paragraph 7.1.1).

A.2.1 ITS test

$$M_S = \frac{(\pi \times d^2)}{4 \times 10^6} \times h \times \left(\text{MDD} \times \left(1 + \frac{\text{OMC}}{100} \right) \right)$$

$$M_S = \frac{(\pi \times 152^2)}{4 \times 10^6} \times 95 \times \left(2\,145 \times \left(1 + \frac{5,6}{100} \right) \right) = 3\,905 \text{ g}$$

A.2.2 Triaxial test

$$M_S = \frac{(\pi \times d^2)}{4 \times 10^6} \times h \times \left(\text{MDD} \times \left(1 + \frac{\text{OMC}}{100} \right) \right)$$

$$M_S = \frac{(\pi \times 150^2)}{4 \times 10^6} \times 300 \times \left(2\,145 \times \left(1 + \frac{5,6}{100} \right) \right) = 12\,008 \text{ g}$$

A.2 Calculate the mass of material required to manufacture a batch of specimens (see paragraph 7.1.2).

A.3.1 ITS test

$$M_B = \frac{(N_S \times M_S)}{1000} + 4 = \frac{(6 \times 3\,905)}{1000} + 4 = 27,4 \text{ kg}$$

A.3.2 Triaxial test

$$M_B = \frac{(N_S \times M_S)}{1000} + 4 = \frac{(6 \times 12\,008)}{1000} + 4 = 124,1 \text{ kg}$$

A.3 Calculate the mass of material required per layer (see 7.1.3).

A.4.1 ITS test

$$M_L = \frac{M_S}{n} = \frac{3\,905}{2} = 1\,953 \text{ g}$$

A.4.2 Triaxial test

$$M_L = \frac{M_S}{n} = \frac{12\,008}{5} = 2\,401 \text{ g}$$

BSM4: DETERMINATION OF THE INDIRECT TENSILE STRENGTH OF BITUMEN STABILISED MATERIAL

1. SCOPE

This test method concerns the determination of the indirect tensile strength of bitumen stabilised material (BSM) in the dry and soaked condition.

2. REFERENCES

The following referenced documents are indispensable for the application of this document. For dated references, only the edition cited applies. For undated references, the latest edition of the referenced document (including any amendments) applies. Information on currently valid national and international standards can be obtained from the SABS Standards Division.

- SANS 1649, Non-automatic self-indicating, semi-self-indicating and non-self-indicating weighing instruments with denominated verification scale intervals.
- SANS 3001-GR20, Civil engineering test methods Part GR20: Determination of the moisture content by oven-drying.
- SANS 3001-GR30, Civil engineering test methods Part GR30: Determination of the maximum dry density and optimum moisture content.
- TG2, Test Method BSM1, Determination of the foaming characteristics of bitumen.
- TG2, Test Method BSM2, Laboratory Mix Design of Bitumen Stabilised Materials.
- TG2, Test Method BSM3, Vibratory hammer compaction for test specimens of bitumen stabilised material.
- TG2, Test Method BSM5, Determination of the shear properties of bitumen stabilised material (Triaxial test).

3. DEFINITIONS

For the purpose of this document, the following definitions apply:

- 3.1 Bitumen stabilised material (BSM)
Granular, previously cement treated or reclaimed asphalt material blends, stabilised either using bitumen emulsion or foamed bitumen.
- 3.2 Indirect tensile strength (ITS)
The stress at failure generated by the load required to split a cylindrical specimen of bitumen stabilised material.
- 3.3 Maximum dry density (MDD)
The maximum dry density of the material determined from the peak of the dry density versus moisture content curve obtained as described in SANS 3001-GR30.
- 3.4 Optimum moisture content (OMC)
The moisture content at which the maximum dry density is achieved.

4. APPARATUS

- 4.1 Compression testing machine
Of capacity at least 30 kN total load, reading to the nearest 50 N and capable of penetrating at a constant rate of 50 ± 5 mm/min, equipped with a force indicating device.

Warning: Compression testing machines that are used to break specimens can apply a force in excess of 20 kN on the sample. Samples of BSM tend to deform in a plastic manner under the applied force. However, it is possible for particles to be expelled from the specimen during the test and it is recommended that the operator of the testing machine wears safety glasses for the duration of the test.

4.2 Force indicating device

Capable of measuring a force of at least 30 kN reading to the nearest 0.05 kN and measuring displacement to the nearest 0.1 mm.

4.3 Indirect tensile strength (ITS) load frame

Consisting of two load platens, of hardened steel, 19 mm × 20 mm × 220 mm, with the 19 ± 0.1 mm face ground concave to a radius of 76 ± 1 mm, together with vertical frame guides, 10 mm × 10 mm × 175 mm, of mild steel attached to a base plate, of mild steel of suitable design to align the loading platens on the test specimen. The upper load platen shall be contained by the guides but shall slide freely between them and shall have a vertical centre-mark on each end face. The lower platen shall be fixed to the base plate. Other frame designs, which incorporate a load transfer plate, load cell and automatic data logger, may be used provided that the load platens comply with the dimensions given.

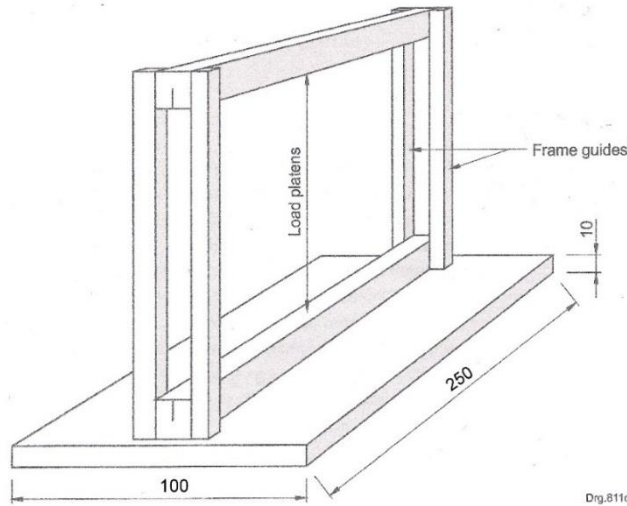

Description	Dimensions (mm)
Loading platen	19 x 20 x 220
Concave face of load platens	76 ± 1

Figure B3 Typical ITS Load Frame

4.4 Load transfer plate

Steel, round or square, or 19 mm diameter steel ball, to transfer the load from the compression testing machine to the top loading platen without any deformation. Its dimensions should be such that it is slightly longer than the specimen to be tested. The ball bearing is not to be used between the load bearing plate and the piston.

4.5 Drying oven

Capable of maintaining a temperature range of 39 °C to 41 °C with continuous forced-draft and of minimum capacity 240 litres.

4.6 Water bath

At least 150 mm deep to ensure that the specimens are covered by at least 25 mm of water, thermostatically controlled with a circulation mechanism to maintain a temperature of 25 °C ± 1 °C, with a perforated false bottom 25 mm high.

4.7 Electronic balance

Fine measurement type complying with SANS 1649 with a capacity of 5 kg and reading to 0.1 g.

4.8 Digital thermometer

Capable of measuring from 0 °C to 100 °C reading to ± 0.1 °C.

4.9 Carrier plates

Plywood with a thickness of approximately 15 mm and diameter approximately 160 mm, one for each compacted specimen.

4.10 Callipers

Steel to measure the height and diameter of the test specimen reading to 0.1 mm.

5. SPECIMEN PREPARATION**5.1 Manufacture**

Prepare and compact six ITS specimens as described in TG2, Test Methods BSM2 and BSM3. Specimens are manufactured at Optimum Moisture Content (OMC) for treatment with foamed bitumen and at Optimum Fluid Content (OFC) for treatment with bitumen emulsion.

Leave the specimens to stand for a minimum of 4 hours before removing them from their respective moulds and carefully placing each on a carrying plate.

5.2 Curing

5.2.1 Before curing, lift one of the specimens off its carrying plate and weigh. Record the mass (MW) to the nearest gram. Place the specimen back on its carrying plate.

5.2.2 Place the six specimens on their carrying plates in the oven at a temperature of 40 ± 1 °C for a period of at least 72 hours. Ensure that there is a minimum air space of 25 mm between specimens.

5.2.3 Remove one specimen per batch from the oven, weigh each one and record the mass to the nearest 1 g.

5.2.4 Return all the specimens to the oven for a further 4 hours.

5.2.5 Remove one specimen per batch from the oven, weigh each one and record the mass to the nearest 1 g.

5.2.6 Compare the masses obtained in the last two weighing cycles. When any specimen loses more than 10 g repeat 5.2.3 to 5.2.4 until no specimen loses more than 10 g.

5.2.7 Leave the specimens to cool to a temperature of 25 °C.

5.3 Measurements

5.3.1 Weigh each specimen and record the mass (MC) to the nearest 0.1 g.

5.3.2 Measure the height at three evenly spaced points around the circumference (h_1 , h_2 and h_3), calculate the average and record to the nearest 0.5 mm.

5.3.3 Measure the diameter at mid-height, at three evenly spaced points (d_1 , d_2 and d_3), calculate the average and record to the nearest 0.1 mm.

5.3.4 Calculate the bulk density of each specimen using the equation given in 7.1.1.

5.3.4.1 Calculate the mean (BD_{ave}) and standard deviation (s) of the bulk density results for the six specimens.

5.3.4.2 Check the set of bulk density results for an outlier using the mean and standard deviation values obtained in 5.3.4.1 and the equation given in 7.1.2.

5.3.4.3 When an outlier is obtained, exclude the specimen with that bulk density value and recalculate the mean and standard deviation for the remaining five values.

5.3.4.4 If a second outlier is obtained either discard all the specimens and repeat the procedure from 5.1 or abandon the test.

6. PROCEDURE

6.1 Unsoaked specimens

6.1.1 Leave the unsoaked specimens in a temperature controlled environment for at least 4 hours to achieve a temperature of 25 ± 1.5 °C.

6.2 Soaked specimens

6.2.1 Place three of the specimens in the water bath and soak for 24 hours at 25 ± 3 °C. Ensure that the specimens are covered by at least 25 mm of water.

6.2.2 Remove the specimens from the water bath, surface dry and test immediately.

6.3 ITS testing

6.3.1 Place the specimen on the bottom loading strip. Then place the top loading strip on top of the specimen, diametrically opposite the bottom strip. Ensure that the loading strips are parallel and centred on the vertical diametrical plane. Place the transfer plate (or steel ball) on the top bearing strip and position the assembly centrally under the loading ram of the compression testing device. Apply a load of 0.1 kN to the specimen to seat the loading strips. Inspect the assembly for symmetry.

6.3.2 Load the specimen at a steady rate of 50 ± 5 mm/min, until the maximum force is achieved. Record the maximum force, G_1 , to the nearest 0.1 kN and record the displacement at peak load to the nearest 0.1 mm.

6.3.3 Unload the compression tester, remove the specimen.

6.3.4 Immediately after testing break each specimen in half. Record the temperature at the centre of the broken face to the nearest 0.1 °C.

6.3.5 Separate the broken unsoaked specimens from the soaked specimens. Break the half portions into small pieces and determine the moisture content of each respective group using SANS 3001 GR20 and record.

7. CALCULATIONS

Note: An example of the calculation procedure is given in Annexure A.

7.1 Calculations required in the procedure

7.1.1 Determine the bulk density of specimens in each set, unsoaked and soaked, to the nearest kilogram per cubic metre, using the following equation:

$$BD = \frac{4 \times 10^6 \times M_C}{(\pi \times d^2) \times h}$$

Where:

- BD bulk density of the treated specimen, in kilograms per cubic metre, (kg/m^3)
- M_C mass of cured treated specimen, expressed in grams (g)
- d diameter of the specimen, expressed in millimetres (mm)
- h is the height of the specimen, expressed in millimetres (mm)

7.1.2 Determine if there is an outlier in the set of bulk density results

7.1.2.1 Sort the BD set in ascending order.

$$BD_{\text{set}} = \{BD_1; BD_2; \dots; BD_n\}$$

7.1.2.2 When $(BD_2 - BD_1) \leq (BD_n - BD_{n-1})$ is true, BD_n is the potential outlier, and when $(BD_2 - BD_1) > (BD_n - BD_{n-1})$ is true, BD_1 is the potential outlier.

7.1.2.3 Check for outlier, using the following equation:

When

$$\frac{|BD_{AVE} - BD_{Potential\ outlier}|}{s} > T_0$$

is true, the value is an outlier.

Where:

BD_{ave} mean of the bulk density set of values

s standard deviation of the bulk density set of values

Table B.12 Critical Outlier Value Versus Number of Samples

Number of specimens n	Critical outlier value T_0
5	1.672
6	1.822

Note: See SANS 3001-PR1, Annex B, Table B.6.

7.1.3 When the potential value is an outlier, discard that value and repeat 7.1.2 to 7.1.3 using the amended data set and calculating new average and standard deviation values. If a second outlier is obtained, repeat or abandon the test.

7.2 Determine the Indirect Tensile Strength of the Treated Material using the following equation:

$$ITS = \frac{2 \times G}{\pi \times d \times h} \times 10^6$$

Where:

ITS indirect tensile strength, in kiloPascals, (kPa)

G applied force, in kiloNewtons, (kN)

d specimen diameter, millimetres (mm)

h specimen height, in millimetres (mm)

7.3 Determine the dry density of each specimen using the following formulae:

$$M_D = \frac{100 \times M_W}{100 + W}$$

Where:

M_D dry mass of the specimen, in grams (g)

M_W mass of the moist specimen after compaction, in grams (g)

W moisture content of the specimen determined during compaction (see SANS 3001-BSM2), as a percentage (%)

$$D_D = \frac{4 \times 10^6 \times M_D}{(\pi \times d^2) \times h}$$

Where:

D_D dry density of the specimen, in kilograms per cubic metre (kg/m³)

8. TEST REPORT

- 8.1 Report the BD to the nearest kg/m^3 ; and the ITS soaked and dry, to the nearest kPa, for:
- a) individual specimens
 - b) mean values for the data set
- 8.2 The test report shall include the following general information:
- a) average specimen height
 - b) details of aggregate and binder used in the mix including mix proportions
 - c) dates of:
 - i) manufacture
 - ii) start and end of curing (including times)
 - iii) testing
 - d) identification of outliers
- 8.3 The test report shall include for each specimen:
- a) identification marking
 - b) moisture content when tested (soaked or unsoaked)
 - c) dry density and moisture content
 - d) specimen height and diameter
 - e) deformation at failure
 - f) maximum load applied
 - g) temperature at centre of specimen

ANNEXURE A: Calculation Procedure

A.1 Use the following information given in Table B.13 to calculate A2, A3 and A4.

Table B.13 Data for Example Calculations

Bulk density		Outlier	
Property	Value	Property	Value (kg/m ³)
M _C	3 836 g	BD ₁	2 244
d	152 mm	BD ₂	2 230
h	94,2 mm	BD ₃	2 251
		BD ₄	2 220/
		BD ₅	2 168
		BD ₆	2 224

A.2 Calculate the bulk density of a specimen (see 7.1.1)

$$BD = \frac{4 \times 10^6 \times M_C}{(\pi \times d^2) \times h} = \frac{4 \times 10^6 \times 3\,836}{(\pi \times 152^2) \times 94.2} = 2\,244 \text{ kg/m}^3$$

A.3 Calculate the mean and standard deviation of the BD data set

$$BD_{AVE} = 2\,222.8 \text{ kg/m}^3 \text{ and } s = 29.4$$

A.4 Determine if an outlier exists (see paragraph 7.1.2).

A.4.1 Sort BD data set into ascending order (see 7.1.2.1)

$$BD_{set} = \{2\,168; 2\,220; 2\,240; 2\,230; 2\,244; 2\,251\}$$

A.4.2 Determine potential outlier (see 7.1.2.2)

$$\begin{aligned} (BD_2 - BD_1) &> (BD_n - BD_{n-1}) = (2\,220 - 2\,168) > (2\,251 - 2\,244) \\ &= (52) > (7) \text{ is true and thus } BD_1 \text{ is the potential outlier} \end{aligned}$$

A.4.3 Check for outlier (see 7.1.2.3)

$$T_0 \text{ for } n = 6 \text{ is } 1.822 \text{ (see Table B.12)}$$

$$\frac{|BD_{AVE} - BD_{\text{Potential outlier}}|}{s} = \frac{|2\,222.8 - 2\,168|}{29.4} = 1.87$$

Thus,

$$\frac{|2\,222.8 - 2\,168|}{29.4} = 1.84 > T_0 = 1.822$$

And BD₁ is an outlier.

Discard BD₁ (2 168 kg/m³) and repeat calculations for the amended BD data set with n=5.

A.5 Use the following information given in Table B.14 to calculate A.6 and A.7.

Table B.14 Data for Example Calculations

1	2
Property	Value
G	5.2 kN
h	94.2 mm
d	152 mm
M _w	3 814 g
W *	5.1 %
* Obtained from SANS 3001-BSM2 compaction data.	

Calculate the ITS (see paragraph 7.2)

$$ITS = \frac{2 \times G}{\pi \times d \times h} \times 10^6 = \frac{2 \times 5.2}{\pi \times 152 \times 94,2} \times 10^6 = 231 \text{ kPa}$$

A.6 Calculate the dry density of each specimen (see paragraph 7.3)

$$M_D = \frac{100 \times M_W}{100 + W} = \frac{100 \times 3,814}{100 + 5,1} = 3,629 \text{ g}$$

$$D_D = \frac{4 \times 10^6 \times M_D}{(\pi \times d^2) \times h} = \frac{4 \times 10^6 \times 3,629}{(\pi \times 152^2) \times 94,2} = 2 \text{ 123 kg/m}^3$$

BSM5: DETERMINATION OF THE SHEAR PROPERTIES OF BITUMEN STABILISED MATERIAL (TRIAXIAL TEST)

1. SCOPE

This test method is concerned with the determination of the shear properties (cohesion (C) and angle of internal friction (ϕ)) of bitumen stabilised material (BSM) using a simple monotonic triaxial test. The specimens tested are 150 mm in diameter and 300 mm high.

2. REFERENCES

The following referenced documents are indispensable for the application of this document. For dated references, only the edition cited applies. For undated references, the latest edition of the referenced document (including any amendments) applies. Information on currently valid national and international standards can be obtained from the SABS Standards Division.

- SANS 1649, Non-automatic self-indicating, semi-self-indicating and non-self-indicating weighing instruments with denominated verification scale intervals.
- SANS 3001-GR20, Civil engineering test methods Part GR20: Determination of the moisture content by oven-drying.
- TG2, Test Method BSM1, Determination of the foaming characteristics of bitumen.
- TG2, Test Method BSM2, Laboratory Mix Design of Bitumen Stabilised Materials.
- TG2, Test Method BSM3, Vibratory hammer compaction for test specimens of bitumen stabilised material.
- TG2, Test Method BSM4, Determination of the indirect tensile strength of bitumen stabilised material.

3. DEFINITIONS

For the purpose of this document, the following definitions apply:

3.1 Bitumen stabilised material (BSM)

Granular, previously cement treated or reclaimed asphalt material, stabilised either using bitumen emulsion or foamed bitumen.

3.2 Shear properties

The values cohesion (c) and angle of internal friction (ϕ) determined from the Mohr-Coulomb circles obtained by plotting the vertical stress (σ_1) applied to the specimens in a simple monotonic triaxial test at a range of confining pressures (σ_3).

4. APPARATUS

4.1 Triaxial cell

Consisting of a confining cylinder and a base and top plate, capable of safely withstanding a confining pressure of at least 200 kPa. The internal dimensions of the cylinder are sufficient to accommodate a 150 mm diameter by 300 mm high specimen enclosed in an inflatable rubber bladder.

4.2 Rubber bladder

With an uninflated internal diameter of 160 ± 5 mm and height of 330 mm, fitted with an inflation valve.

Warning: The rubber bladder is only to be inflated after the confining cylinder has been properly assembled with a specimen of the specified diameter and height. Improper assembly of the confining cylinder and/or attempting to use a smaller specimen can result in the bladder blowing out (exploding) when inflated, especially when high inflation pressures are applied. Such a blow-out has the potential to cause serious bodily harm.

4.3 Compression testing machine

Capable of applying a force of at least 200 kN reading to the nearest 0.1 kN at a constant rate of 3 mm/min and measuring vertical displacement to the nearest 0.1 mm. The machine shall be capable of taking readings at 1 second intervals and shall have sufficient clearance to accommodate the assembled confining cylinder and top and plates. The moving actuator / loading ram is to be situated above the triaxial cell with a fixed reaction base below the cell.

4.4 Air compressor

With pressure gauge reading to 1 kPa and regulator capable of inflating the bladder and maintaining a maximum pressure of 200 ± 2.5 kPa.

4.5 Drying oven

Capable of maintaining a temperature of 40 ± 1 °C with continuous forced-draft and of minimum capacity 240 litres.

4.6 Water bath

At least 350 mm deep to ensure that the specimens are covered by at least 25 mm of water, thermostatically controlled with a circulation mechanism to maintain a temperature of 25 ± 1 °C, with a perforated false bottom 25 mm high.

4.7 Electronic balance

Fine measurement type that complies with SANS 1649 with a capacity of 20 kg and reading to ± 0.1 kg.

4.8 Digital thermometer

Capable of measuring from 0 °C to 100 °C reading to ± 0.1 °C.

4.9 Carrier plates

Plywood of thickness approximately 15 mm and diameter approximately 160 mm, one for each compacted specimen.

4.10 Plastic bags

Capacity 10 litres which can be sealed watertight.

5. SPECIMEN PREPARATION**5.1 Manufacture**

Prepare and compact ten triaxial specimens as described in the TG2, Test Methods BSM2 and BSM3. Specimens are manufactured at Optimum Moisture Content (OMC) for treatment with foamed bitumen and at Optimum Fluid Content (OFC) for treatment with bitumen emulsion.

5.2 Measuring and conditioning the specimens

5.2.1 Leave all ten specimens overnight in their respective moulds covered with a moist hessian cloth.

5.2.2 Remove the specimens from their respective moulds the following morning. Mark each one with an appropriate identity number.

5.2.3 Place the specimens in the oven at a temperature of 40 ± 1 °C for 8 hours. Ensure that there is a minimum air space of 25 mm between specimens. To avoid damage to the large specimens, exercise care when moving them. Specimens are always moved on their respective carrier plates.

5.3 Curing

- 5.3.1 After 8 hours (i.e., when 5.2.3 is complete), remove all the specimens from the oven. Place each specimen in a loose-fitting plastic bag and seal the bag.
- 5.3.2 Place the specimens (in plastic bags) into the oven at a temperature of 40 ± 1 °C for 48 hours.
- 5.3.3 Remove the specimens from the oven after 48 hours and take them out of their respective plastic bags.
- 5.3.4 Weigh each specimen and record the mass (M_{PC}) to the nearest gram.
- 5.3.5 Measure the height at three evenly spaced points around the circumference (h_1 , h_2 and h_3), calculate the average and record to the nearest 0.1 mm.
- 5.3.6 Measure the diameter at mid-height, at three evenly spaced points (d_1 , d_2 and d_3), calculate the average and record to the nearest 0.1 mm.
- 5.3.7 Place two of the specimens under water for 24 hours in a soaking bath at a temperature of 25 °C. After 24 hours, remove the specimens from the water, surface dry and weigh before testing. Ensure that the specimens are covered by at least 25 mm of water.
- 5.3.8 Place the other eight specimens in fresh (dry) loose fitting plastic bags and leave to cool to 25 ± 2 °C for a minimum period of 12 hours. Each specimen is then removed from its plastic bag and tested.

5.4 Identify outliers

- 5.4.1 Calculate the bulk density (BD) of each specimen using the equation given in 7.1.1.
- 5.4.2 Calculate the mean (BD_{ave}) and standard deviation (s) of the bulk density results for the ten specimens.
- 5.4.3 Check the set of bulk density results for an outlier using the mean and standard deviation values obtained in 5.4.2 and the equation given in 7.1.2.
- 5.4.4 When an outlier is identified, exclude that bulk density value and recalculate the mean and standard deviation for the remaining nine values.
- 5.4.5 If a second outlier is identified, exclude that bulk density value and recalculate the mean and standard deviation for the remaining eight values.
- 5.4.6 If a third outlier is identified, abandon the test.

6. PROCEDURE

6.1 Preparation of test assembly

- 6.1.1 Fit the specimen carefully into the bladder inside the confining cylinder. Position the cylinder and specimen in the middle of the base plate taking care not to damage the edges of the specimen. Fasten the cylinder to the base plate. Carefully position the top plate on the specimen.
- 6.1.2 Check that there is sufficient space between the actuator / loading ram and the fixed reaction base of the compression testing machine. Place the assembly of specimen, cylinder and plates, on the reaction base of the compression testing machine and align correctly.
- 6.1.3 Lower the loading ram until it makes contact with the depression in the centre of the top plate. Monitor the load cell reading to ensure that the specimen is not loaded during this process.
- 6.1.4 Connect the air supply to the inflation valve protruding through the confining cylinder. Adjust the pressure regulator to inflate the bladder to the required pressure.
- 6.1.5 The monotonic triaxial testing is undertaken at four different confining pressures (σ_3): 0 kPa, 50 kPa, 100 kPa and 200 kPa.
Where sufficient specimens are available, two unsoaked (dry) specimens are tested at each confining pressure. When one specimen is identified as an outlier and excluded, test only one unsoaked specimen at a confining pressure of 50 kPa. If two specimens were excluded, test one unsoaked specimen at both the 50 kPa and 100 kPa confining pressures.
The two soaked specimens are tested at a confining pressure of 100 kPa.

6.2 Triaxial test

- 6.2.1 Set the compression testing machine in displacement control mode at a rate of 3 mm/min. Ensure that the load (f_i) and displacement (Δ_i) readings are measured and recorded every second.
- 6.2.2 Apply the vertical load up to a displacement of 18 mm (6% strain), or sooner if the load starts to reduce from the maximum.
- 6.2.3 Unload the specimen by returning the actuator to its start position and release the confining pressure. Move the actuator clear of the top plate and remove the confining cylinder assembly from the loading frame. Dismantle the confining cylinder and carefully remove the specimen from the bladder. Immediately break the specimen and record the temperature in the centre and middle to the nearest 0.1 °C.
- 6.2.4 Take a sample of approximately 1 000 g of material from the middle portion of the specimen and place in a sealed container. Determine the moisture content as described in SANS 3001-GR20.
- 6.2.5 Repeat the procedure until all the specimens (unsoaked and soaked) have been tested at the confining pressures given in 6.1.5.

7. CALCULATIONS

Note: An example of the calculation procedure is given in Annexure A.

7.1 Calculations required in the procedure

- 7.1.1 Determine the bulk density of each specimen to the nearest kilogram per cubic metre, using the following equation:

$$BD = \frac{4 \times 10^6 \times M_{PC}}{(\pi \times d^2) \times h}$$

Where:

- BD bulk density of the treated specimen, in kilograms per cubic metre (kg/m^3)
- M_{PC} mass of the treated specimen, expressed in grams (g)
- d diameter of the specimen, expressed in millimetres (mm)
- h height of the specimen, expressed in millimetres (mm)

- 7.1.2 Determine if there is an outlier in the set of bulk density results

- 7.1.2.1 Sort the BD set in ascending order.

$$BD_{set} = \{BD_1; BD_2; \dots; BD_n\}$$

- 7.1.2.2 When $(BD_2 - BD_1) \leq (BD_n - BD_{n-1})$ is true, BD_n is the potential outlier, and when $(BD_2 - BD_1) > (BD_n - BD_{n-1})$ is true, BD_1 is the potential outlier.

- 7.1.2.3 Check for outlier, using the following equation:

When:

$$\frac{|BD_{AVE} - BD_{Potential\ outlier}|}{s} > T_0 \quad \text{the value is an outlier.}$$

Where:

- BD_{ave} mean of the bulk density set of values
- s standard deviation of the bulk density set of values

Table B.15. Critical Outlier Value Versus Number of Samples

Number of specimens n	Critical outlier value T_0
8	2.03
9	2.11
10	2.18

Note: See SANS 3001-PR1, Annex B, Table B.6.

7.1.3 When the potential value is an outlier, discard that value and repeat 7.1.2 using the amended data set (with only 9 values) to calculate new average and standard deviation values. If a second outlier is obtained, discard that value as well and repeat 7.1.2 using the amended data set (with only 8 values) to obtain new average and standard deviation values. If a third outlier is obtained, repeat or abandon the test.

7.2 Determine the triaxial shear properties cohesion (C) and angle of internal friction (φ)

7.2.1 Plot the applied vertical load (f_i) on the vertical axis versus displacement (Δ_i) on the horizontal axis for each specimen using the compression testing machine output. Read off and record the force at peak load or 18 mm displacement, (f_p), whichever is less, and the confining pressure (σ_3) for each specimen.

7.2.2 Calculate the total applied peak stress.

7.2.2.1 Determine the applied failure stress measured by the compression testing machine, using the following equation:

$$\sigma_{1P} = \frac{4 \times f_p \times 10^6}{(\pi \times d^2)}$$

Where:

σ_{1P} applied peak stress measured by compression testing machine, in kilopascals (kPa)

f_p applied peak load, in kilonewtons (kN)

d specimen diameter at the start of the test, in millimetres (mm)

7.2.2.2 Determine the total applied failure stress including the dead weight of the top plate and loading ram, using the following equation:

$$\sigma_{1TP} = \sigma_{1P} + \frac{4 \times M_{DW} \times 9,81}{(\pi \times d^2)}$$

Where:

σ_{1TP} total applied stress including the weight of the top plate and loading ram, in kilopascals, (kPa)

M_{DW} mass of the top plate and loading ram, in grams (g)

9,81 is the standard acceleration due to gravity, in metres per second per second (m/s²)

7.2.3 Plot the total applied stress (σ_{1TP}) on the vertical axis versus the confining stress (σ_3) on the horizontal axis; for all the unsoaked specimens.

7.2.3.1 Select the best fit straight line through the points.

7.2.3.2 Determine the slope of the best fit line (A) and the intercept with the vertical axis (B).

Note: Commercial spreadsheets are available to plot the points, provide a best fit line and calculate a linear regression equation. A graphical interpretation should provide an answer within 2% of the calculated value.

7.3 Determine the shear properties cohesion (C) to the nearest kilopascal and angle of internal friction (φ) to the nearest first decimal place of a degree, using the following equations

$$\phi = \sin^{-1} \left(\frac{A - 1}{A + 1} \right)$$

and

$$C = B \times \frac{1 - \sin \phi}{2 \times \cos \phi}$$

7.4 Determine the retained cohesion, expressed as the net applied stress after and before soaking, as a percentage, using the following equation

$$RetC = \frac{(\sigma_{1WET,F} - \sigma_3)}{(\sigma_{1EQUIL,F} - \sigma_3)} \times 100$$

Where:

- RetC* retained cohesion after soaking, expressed as a percentage;
σ₃ confining pressure in kilopascals (kPa)
σ_{1,WET,F} soaked applied peak stress at confining pressure *σ₃*, in kilopascals (kPa)
σ_{1,EQUIL,F} unsoaked applied peak stress read from the best fit line at confining pressure (*σ₃*) in kilopascals (kPa).

7.5 Determine the dry density and moisture content after curing and soaking using the following equation

$$D_T = \frac{100 \times M_{PS} \times 4 \times 10^6}{(100 + W_{PS}) \times (\pi \times h \times d^2)}$$

Where:

- D_T* dry density when tested, expressed in kilograms per cubic metre (kg/m³)
M_{PS} mass after soaking and just before testing, expressed in grams (g)
W_{PS} moisture content measured just after testing, expressed as a percentage (%)

8. TEST REPORT

8.1 Report

- The slope (A) to two decimal places and intercept of the vertical axis (B) to the nearest kPa of the best fit *σ₁* versus *σ₃* line.
- The cohesion (C) to the nearest kPa.
- The internal angle of friction (φ) to the first decimal of a degree.
- The retained cohesion (*C_{RET}*) to the nearest percentage point.

8.2 The test report shall include the following general information:

- average specimen height
- details of aggregate and binder used in the mix, including mix proportions and binder used
- the following dates of:
 - manufacture
 - start of moisture content adjustment (including time)
 - start and end of curing (including times)
 - testing
- identification of outliers

8.3 The test report shall include for each specimen:

- identification marking
- condition when tested (soaked or unsoaked)
- dry density and moisture content
- specimen height and diameter
- bulk density
- deformation at failure
- maximum load applied
- temperature at centre of specimen
- moisture content after testing, soaked and unsoaked specimens
- dry density
- confining pressure (*σ₃*)
- peak load (*f_p*)
- total applied stress (*σ_{1TP}*)

ANNEXURE A: Calculation Procedure

A.1 Use the following information given in Table B.16 calculate A2, A3 and A4.

Table B.16 Data for Example Calculations to Check for Outlier

1	2	3	4
Bulk Density		Outlier	
Property	Value	Property	Value (kg/m ³)
M _{PC}	12 926 g	BD ₁	2 407
d	150 mm	BD ₂	2 449
h	302 mm	BD ₃	2 422
		BD ₄	2 434
		BD ₅	2 404
		BD ₆	2 418
		BD ₇	2 412
		BD ₈	2 407
		BD ₉	2 403
		BD ₁₀	2 415

A.2 Calculate the bulk density of a specimen (see 7.1.1).

$$BD = \frac{4 \times 10^6 \times M_{PC}}{(\pi \times d^2) \times h} = \frac{4 \times 10^6 \times 12\,929}{(\pi \times 150^2) \times 302} = 2\,422 \text{ kg/m}^3$$

A.3 Calculate the mean and standard deviation of the BD data set.

$$BD_{ave} = 2\,417.1 \text{ kg/m}^3$$

$$s = 14.65$$

A.4 Determine if an outlier exists (see 7.1.2).

A.4.1 Sort BD data set into ascending order (see 7.1.2.1).

$$Bd_{set} = \{2\,403; 2\,407; \dots ; 2\,434; 2\,449\}$$

A.4.2 Determine potential outlier (see 7.1.2.2).

$$(BD_2 - BD_1) \leq (bd_n - bd_{n-1}) = (2\,403 - 2\,407) \leq (2\,449 - 2\,434) = 4$$

$$(4) \leq (15) \text{ is true and thus } BD_{10} \text{ is the potential outlier.}$$

A.4.3 Check for outlier (see 7.1.2.3).

$$\text{for } n = 10 \text{ samples } T_0 = 2.176 \text{ (see Table B.15)}$$

$$\frac{|BD_{AVE} - BD_{Potential\ outlier}|}{s} = \frac{|2\,417.1 - 2\,449|}{14.65} = 2.178$$

Thus,

$$\frac{|BD_{AVE} - BD_{Potential\ outlier}|}{s} = 2,178 > T_0 = 2,176$$

And, BD_{10} is an outlier.

Discard BD_{10} (2 449 kg/m³) and repeat calculations for the amended BD data set.

A.5 Use the following information given in Table B.17 to calculate A.6 and A.7

Table B.17 Data for Example Calculations for Test Values

1	2
Property	Value
M_M	12 926 g
M_{Ci}	12 496 g
OMC or OFC	5.5%
d	150 mm
f_p	49.7 kN
M_{DW}	5 100 g
M_{PS}	12 875 g
W_{PS}	3.5%

A.6 Calculate the dry density at time of testing

$$D_T = \frac{100 \times M_{PS} \times 4 \times 10^6}{(100 + W_{PS}) \times (\pi \times h \times d^2)} = \frac{100 \times 12,875 \times 4 \times 10^6}{(100 + 3,5) \times (\pi \times 302 \times 150^2)} = 2\,331 \text{ kg/m}^3$$

A.7 Calculate the total applied peak stress

$$\sigma_{1P} = \frac{4 \times f_p \times 10^6}{(\pi \times d^2)} = \frac{4 \times 49,7 \times 10^6}{(\pi \times 150^2)} = 2\,812 \text{ kPa}$$

and

$$\sigma_{1TP} = \sigma_{1P} + \frac{4 \times M_{DW} \times 9,81}{(\pi \times d^2)} = 2\,812 + \frac{4 \times 5\,100 \times 9,81}{(\pi \times 150^2)} = 2\,815 \text{ kPa}$$

A.8 Use the following information given in Table B.18 to calculate A.9 to A11:

Table B.18 Data for Example Calculations

σ_3	Measured Stresses (kPa)			
	σ_1			
	Unsoaked	Soaked		
0	1 270	1 262		
50	1 436	1 515		
100	1 821	1 772	1 381	1397
200	2 255	2 315		

A.9 Calculate the best fit line, intercept value and slope

Using the data in Table B.18 and a commercial spreadsheet, determine the best fit equation for the σ_3 versus σ_1 .

$$f(x) = 5.18457x + 1\,252.1$$

and thus,

$$A \text{ the slope of the line} = 5.18$$

$$B \text{ the intercept with the y axis} = 1\,252 \text{ kPa}$$

A.10 Calculate the shear stresses c and ϕ

$$\phi = \sin^{-1} \left(\frac{A - 1}{A + 1} \right) = \sin^{-1} \left(\frac{5.18 - 1}{5.18 + 1} \right) = 42.6$$

and

$$C = B \times \frac{1 - \sin \phi}{2 \times \cos \phi} = 1\,252 \times \frac{1 - \sin 42,6\phi}{2 \times \cos 42,6} = 275 \text{ kPa}$$

A.11 Calculate the retained cohesion

Using the data in Table B.18:

Mean soaked applied peak stress at 100 kPa confining pressure

$$= 0.5 \times (1\,381 + 1\,397) = 1\,389 \text{ kPa}$$

Mean unsoaked applied peak stress at 100 kPa confining pressure

$$= 0.5 \times (1\,821 + 1\,772) = 1\,796.5 \text{ kPa}$$

$$\text{RetC} = \frac{(\sigma_{1S,F} - \sigma_3)}{(\sigma_{1US,F} - \sigma_3)} \times 100 = \frac{(1\,389 - 100)}{(1\,796.5 - 100)} \times 100 = 76\%$$

APPENDIX C: STRUCTURAL DESIGN: PAVEMENT NUMBER GUIDELINES AND WORKED EXAMPLE WITH PAVEMENT NUMBER AND MECHANISTIC-EMPIRICAL CRITERIA

C.1	PAVEMENT NUMBER	175
C.2	APPLICABILITY AND LIMITATIONS OF THE PAVEMENT NUMBER METHOD	175
C.3	RULES OF THUMB / DEPARTURE POINTS.....	176
C.4	PAVEMENT NUMBER CALCULATION.....	180
C.5	PAVEMENT CAPACITY CALCULATION.....	188
C.6	WORKED EXAMPLE	189

This appendix covers the full guidelines for using the second version of the Pavement Number, PN (2020). At the end of the chapter, a worked example is given using both the PN and the Mechanistic-Empirical Design with the Stellenbosch BSM Design Function.

C.1 PAVEMENT NUMBER

The basic principle of pavement design is to provide structural layers to protect the pavement subgrade against the stresses imposed by traffic. The combined system, consisting of the structural layers and the subgrade, should function as a unit in a balanced system to achieve the desired design structural capacity. In essence, pavement balance requires that there should be a gradual decrease in strength from the top to the bottom pavement layers. The exception to this is the use of inverted pavement structures in South Africa.

One method for the structural design of pavements incorporating Bitumen Stabilised Materials is the Pavement Number (PN). This is a knowledge based approach based on the Structural Number concept, which was used in the original AASHTO methods (AASHTO, 1996). However, some of the shortcomings of the Structural Number have been overcome in the PN method. The original development and validation of the PN method are described in Jooste, et al (2007) and Long (2009), and the revision in Johns and Hefer (2020). The method is applicable to all pavement materials commonly used in southern Africa. The PN method was chosen for several reasons.

Data from in-service pavements were used to develop the method. The type and detail of the data suggests the use of a relatively simple method and precludes the use of a Mechanistic-Empirical design method:

- The method gives a **good fit** to the available field data.
- The method is **robust**, and cannot easily be manipulated to produce inappropriate designs.

This method relies on basic points of departure, or rules-of-thumb, which reflect well-established principles of pavement behaviour and performance, and which will ensure an appropriate pavement design solution in most situations. The concepts in the rules-of-thumb are quantified into specific rules with constants or functions associated with each rule. The rules-of-thumb are described in the next section.

The PN method was initially calibrated by calculating the PN value for several pavements extracted from the TRH4 catalogue (TRH4, 1996), and for which the structural capacities were known with some certainty from experience. Using these data, the quantified rules-of-thumb were adjusted to optimize the correlation between PN and structural capacity. The final rules were then validated using observed pavement performance data. These rules were published in the TG2 (2009) Second Edition. For the recalibration, the process was repeated using a larger database of actual pavement structures. Some of the identified shortcomings of the original PN method were corrected. The development of the rules-of-thumb and the calibration and initial validation processes are described by Jooste and Long (2007), and the recalibration described by Johns and Hefer (2020).

The PN method is designed to be used in conjunction with the DEMAC material classification system described in Appendix A. The method is applicable to both new construction and rehabilitation. For rehabilitation projects, the material class would be the design equivalent material class (DEMAC). For brevity, in this Appendix, the term material class is used for both new construction and rehabilitation.

C.2 APPLICABILITY AND LIMITATIONS OF THE PAVEMENT NUMBER METHOD

Before the Pavement Number method is used, the designer must check that the following situations **do not apply**:

- **Design traffic greater than 40 MESA.** The method was calibrated using a knowledge base which was limited to pavements that had accommodated less than 40 MESA. Thus, in such a design situation, the design should be checked using more in-depth analysis.
- **Presence of thin, weak lenses.** If thin, weak lenses of material exist below the surfacing, or between stabilised layers, then zones of high slip and shear develop, and the PN calculations do not apply. In such instances, the structural capacity assessment of the PN method is not appropriate, and special treatment of the affected weak lens must be undertaken. The PN design method cannot be applied to situations where such lenses

still exist within the pavement structure, especially where such lenses are located within the upper 400 mm of the pavement structure. This is applicable to most standard pavement design methods.

- Subgrade CBR less **than 3%**. The knowledge base on which the PN method was calibrated did not include any pavements that had a subgrade CBR less than 3%. The PN method should therefore not be used in cases where the subgrade CBR is less than 3% at a depth of 600 mm below the surface.
- **Thickness limits.** The PN has been calibrated for thicknesses within certain limits. Details are given in Table C.3.

C.3 RULES OF THUMB / DEPARTURE POINTS

This section presents a discussion of the basic rules-of-thumb underlying the method for calculating the PN. These rules-of-thumb reflect well-established principles of pavement behaviour and performance. The following rules-of-thumb were adopted as the points of departure for the calculation of the Pavement Number:

Rules Relating to the Pavement System in General:

- The structural capacity of a pavement is a function of:
 - The combined long term load spreading potential of the pavement layers.
 - The relative quality of the subgrade on which the pavement is constructed.
- The relative quality and stiffness of the subgrade is the departure point for design, as the subgrade is a key determinant in the overall pavement deflection and in the relative degree of bending and shear that will take place in overlying pavement layers.

For pavements with thin surfacings, the base layer is the most critical component, and failure in this layer effectively constitutes pavement failure. Experience can guide the relative confidence in different material types to serve as base layers under heavy traffic.

Rules Relating to Specific Pavement Layers:

- The load spreading potential of an individual layer is a product of its thickness and its effective long term stiffness under loading.
- The effective long term stiffness (ELTS) of a layer depends on the material type and on its placement in the pavement system.
- Fine-grained subgrade materials act in a stress-softening manner. For these materials, the ELTS is determined mainly by the material quality and by the climatic region. Owing to the stress softening behaviour, subgrade materials will generally soften with decreased cover thickness.
- Coarse-grained, unbound layers act in a stress-stiffening manner. For these materials, the ELTS is determined mainly by the material quality and the relative stiffness of the supporting layer. The ELTS of these materials increases with increasing support stiffness, by means of the Modular Ratio limit, up to a maximum stiffness, which is determined mainly by the material quality.
- Cement stabilised materials initially act as a stiff, glassy material, but gradually deteriorate into a material with stiffness properties more like a granular material. For a specific DEMAC, the rate of deterioration depends mainly on the thickness of the layer and on the stiffness of the support.
- Thin asphalt surfacings act as either stiff, glassy material, or as semi-stiff, rubbery material. The material state depends primarily on the temperature and bitumen content. Over time, the material is subject to deterioration owing to ageing and fatigue. Fatigue breakdown is primarily dependent on the stiffness of the supporting layer.
- Bitumen stabilised materials with low cement contents ($\leq 1\%$) are assumed to act in a similar way to coarse granular materials, but with a higher cohesive strength. The cohesive strength is subject to breakdown during loading, and thus some softening over time can occur. The rate of softening is mainly determined by the

stiffness of the support, which determines the degree of shear in the layer. However, owing to the higher cohesive strength in bituminous stabilised materials, these layers are less sensitive to the support stiffness than unbound granular materials, and thus can sustain higher Modular Ratio limits.

- For asphalt, cemented stabilised and BSM layers, as the layer thickness increases, the higher stiffness values contribute too significantly to the Pavement Number. This is a result of the empirical nature of the method. For this reason, a thickness adjustment factor is included to reduce the unreasonable contribution to the Pavement Number for these layers.

The above-noted rules-of-thumb introduce several concepts, like the ELTS, Modular Ratio limit and stress-stiffening behaviour. These aspects will be discussed in more detail in the following subsections.

C.3.1 The Effective Long Term Stiffness (ELTS)

The ELTS is a model parameter which serves as a relative indicator of the average long term in situ stiffness of a pavement layer. As such, the ELTS averages out effects of a long term decrease of stiffness owing to traffic related deterioration, seasonal variations in stiffness and changes in materials over time. Thus, the ELTS does not represent the stiffness of a material at any specific time.

The ELTS is not a stiffness value that can be determined by means of a laboratory or field test. It is a model parameter, which is calibrated for use in the PN design method and it may, therefore, differ from stiffness values typically associated with material classes, e.g. SAPEM, Chapter 10 (2014).

The ELTS concept is especially needed in the case of cement stabilised materials, where a significant change in the effective stiffness of the material can be expected during the course of a pavement’s design life (de Beer, 1990; Theyse et al, 1996; TRH4, 1996). This concept is illustrated in Figure C.1, which shows the reported breakdown of a cement stabilised material under traffic, with the ELTS representing an average effective long term stiffness.

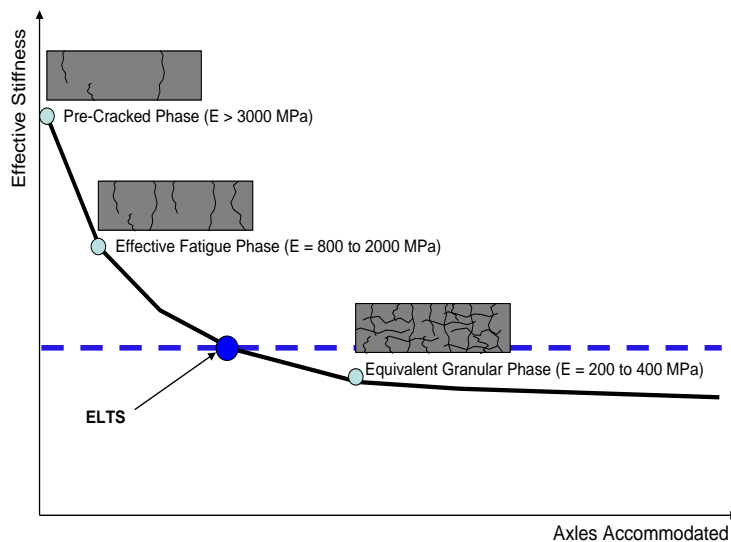

Figure C.1 Application of the ELTS Concept for Cement Stabilised Materials

C.3.2 Modelling of Subgrade Materials

Characterization of the support condition is critical to the pavement design. For new construction, the TRH4 procedure for delineation of the in situ subgrade and for importing selected subgrade material, applies to the PN method, if the structural strength of the in situ subgrade is insufficient. For rehabilitation projects, the guidelines in TRH12 (1997) or SAPEM (2014) for evaluating and designing for changing support conditions should be followed in conjunction with the PN method.

The first step in the calculation of the PN-value is the determination of the subgrade material class. Specific guidelines to determine the DEMAC material class are provided in Appendix A. Once the subgrade class has been determined, the ELTS for the subgrade is calculated. This involves the following steps:

Step 1. Assignment of a basic long term stiffness based on the materials class.

Step 2. Adjustment of the basic long term stiffness for different climatic regions: wet, dry or moderate.

Step 3. Adjustment of the stiffness determined in step 2 to take account of depth of subgrade cover.

The adjustment of the subgrade stiffness for the depth of cover takes account of the stress-softening tendencies of fine grained materials, in which these materials tend to soften under load. The relationship between the cover depth and the adjustment to the subgrade stiffness is given in Section C.4 and Figure C.3.

C.3.3 The Modular Ratio Limit and Maximum Allowed Stiffness

The Modular Ratio is defined as the ratio of a layer's stiffness relative to the stiffness of the layer below it. Thus, if the stiffness of a base layer is 300 MPa, and the stiffness of the support below it is 150 MPa, then the Modular Ratio of the base layer would be $300/150=2$.

The Modular Ratio accounts for the stress-sensitive stiffness of granular materials, which causes the stiffness of a granular material to decrease when the material is placed over a weaker (less stiff) support. This decrease in stiffness occurs because, in situations where the support layer is soft, the overlying layers tend to bend more into the support, thereby increasing the tendency to develop higher shear and tensile forces in the overlying layers. This effect limits the stiffness that can be obtained in an unbound layer placed over a weaker support. By placing a limit on the Modular Ratio that can be sustained for a specific material, it is ensured that the stiffness value assumed for that layer is realistic, given the material quality and stiffness of the support. In essence, the concept of a limiting Modular Ratio for granular materials ensures that stress-sensitive stiffness behaviour is implicitly taken into account.

The Modular Ratio that a material can sustain varies over the life of a pavement. The concept of pavement balance, as discussed by Maree (1982) and Kleyn (1984) essentially assumes that the Modular Ratio of different unbound layers in a pavement system will decrease over time, as the traffic moulds and densifies the material into a more uniform or balanced system. Thus, while it is possible for a high quality crushed stone to maintain a Modular Ratio of 4 to 5 right after construction, over time the material will be moulded and weakened by traffic into a more balanced state where a Modular Ratio of 3 or less is likely to be observed. It is thus important to note that the use of a Modular Ratio limit, as defined for the PN method, pertains to the overall long term stiffness that a material can maintain over time.

Materials have a maximum stiffness that can be achieved. This depends on the inherent quality and shear strength of the material, material properties and the effects of loading. Less dense and poorly graded materials cannot develop very high stiffnesses under loading, regardless of the stiffness of the support.

In the PN model, the Modular Ratio limit and the maximum allowed stiffness are used extensively to determine realistic ELTS values.

These parameters are used in the following way:

1. The stiffness of the supporting layer is first determined. Thus, the PN calculation process starts from the subgrade and proceeds upward toward the surfacing.
2. The Modular Ratio limit and maximum allowed stiffness are determined based on the DEMAC.
3. The ELTS for a layer is determined as the minimum of:
 - The support stiffness multiplied by the Modular Ratio limit.
 - The maximum allowed layer stiffness.

In the case of base layers, the ELTS is further adjusted by means of a base confidence factor, which is discussed in more detail in Section C.4. The Modular Ratio limit and maximum allowed stiffness are also applied to cement stabilised and hot mix asphalt materials, as explained below.

C.3.3.1 Modular Ratio Limit for Cement Stabilised Materials and Hot Mix Asphalt

Modular Ratio limits do not normally apply to cohesive materials such as cement stabilised and hot mix asphalt layers. This is because of the high cohesion inherent in such materials, which effectively removes the stress-sensitivity and ensures that these materials can maintain a relatively high stiffness under loading, even over weak support.

However, when the long term stiffness of these materials is considered, then the stiffness of the support again becomes relevant. This is because weaker support layers lead to increased fatigue and hence faster breakdown of stabilised layers. Thus, when these materials are used in a simplified model, the Modular Ratio limit mimics the long term fatigue effect that leads to quicker reduction of the stiffness when these materials are placed over softer support.

This effect is illustrated schematically in Figure C.2, which shows a case where the same cement stabilised material is placed over a stiff and soft support. Because the cement stabilised material is the same in both instances, the initial and final stiffness values are the same. However, the material on soft support experiences more rapid stiffness reduction, and thus the effective stiffness over the long term is lower than for the material on the stiff support.

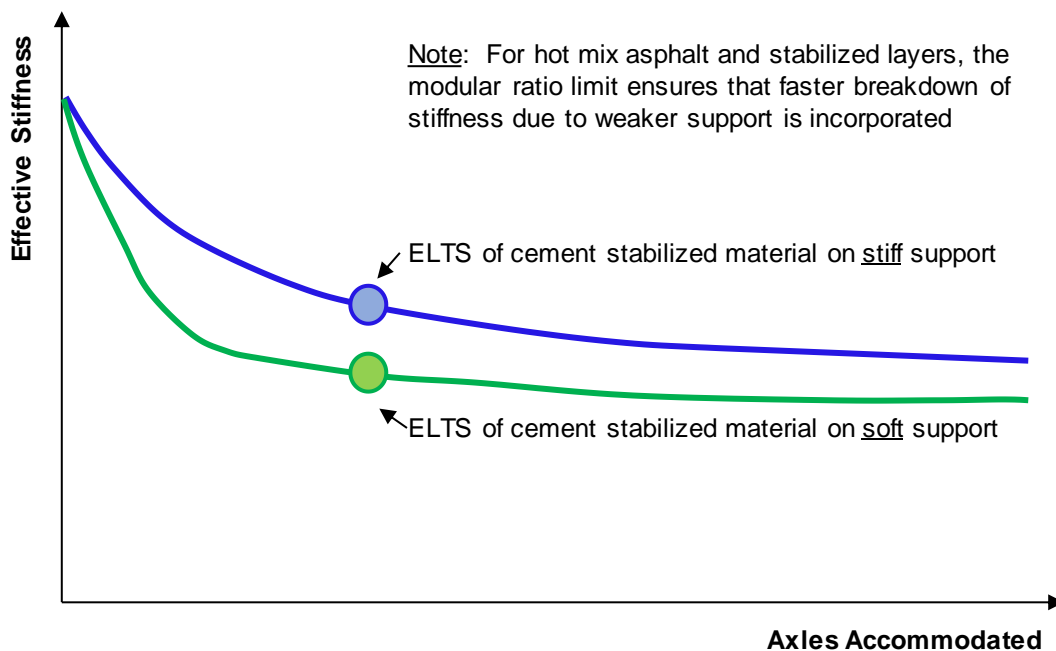

Figure C.2 Modular Ratio Limit for Cement Stabilised Materials

C.3.3.2 Modular Ratio Limit for Bitumen Stabilised Materials

The Modular Ratios of BSMs and the ELTS values are higher than that of granular materials for the reasons given in Section C.3, Rule 10.

C.3.4 The Base Confidence Factor

The type of material in the base layer is an important determinant of the performance of the pavement because the base is the main load bearing element in the pavement system, and failure of the base effectively constitutes pavement failure. Experience has shown that there is a limit on the types of base materials that can be considered for any given design traffic. In particular, suitable design options are significantly limited as the design traffic increases.

In the PN method, the appropriateness of the base material is controlled by the Base Confidence Factor (BCF). The BCF is used to adjust the ELTS value for the base layer. This is done simply by multiplying the initial ELTS for the base with the BCF.

C.3.5 Thickness Adjustment Factors

As cohesive and stabilised layers (asphalt, cement, BSM) increase in thickness, their high stiffness values result in an over contribution to the Pavement Number. This is a result of the empirical nature of the method. To mitigate this effect, a thickness adjustment factor is introduced, which is applicable for the thicker layers.

C.4 PAVEMENT NUMBER CALCULATION

In this section, the stepwise method for calculating the PN is detailed. Details relating to different steps or concepts in the method are discussed in the subsections that follow. In a pavement design situation, the steps described are applied for each uniform design section. For rehabilitation design situations, it is thus presumed that the designer will have detailed information on the existing pavement layer properties for each uniform section.

Step 1. Check to ensure that the design method is applicable for the design situation (see Section C.2 for details). If the design method is not applicable, a more detailed analysis should be performed, and the PN method should not be used.

Step 2. Determine the layer thicknesses, and available material properties for each layer. Use the material properties to obtain a DEMAC for each layer (see Appendix A). To prevent the use of unrealistic layer thickness assumptions, maximum and minimum practical design thickness are prescribed for different material types. The limits are also constrained by the data used to calibrate and validate the PN method (Johns and Hefer, 2020). The layer thickness limits are shown in Table C.3.

Step 3. Combine layers with similar properties to obtain a five layer pavement system, including the subgrade (see Section C.4.1 for details). Check that the layer thicknesses do not exceed the maximum for design purposes (see Table C.3 for details).

Step 4. Determine the basic stiffness of the subgrade by means of Table C.1. Adjust the stiffness for climatic region and depth of subgrade cover (Figure C.3) by multiplying the basic stiffness by the climate adjustment factor and adding the subgrade cover adjustment factor. The resulting stiffness is the ELTS for the subgrade.

Step 5. For each layer above the subgrade, determine the Modular Ratio limit and maximum allowed stiffness from Table C.3.

Step 6. Use the Modular Ratio limit and maximum allowed stiffness to determine the ELTS for each layer by working up from the subgrade (see Section C.4.2). Calculate the ELTS of the layer by multiplying the stiffness of the layer underneath and the Modular Ratio, and checking it does not exceed the maximum allowed stiffness.

$$ELTS = \text{minimum of } (ELTS_{\text{layer below}} * \text{Modular Ratio}) \text{ and Maximum Allowed Stiffness}$$

Step 7. For the base layer, determine the Base Confidence Factor (BCF) from Table C.3.

Step 8. For asphalt surfacing, base, BSM and cement stabilised layers, determine the thickness adjustment factors based on Figure C.4, Figure C.5, Figure C.6 and Figure C.7.

Step 9. For each layer, calculate the layer contribution by multiplying the ELTS with the layer thickness and dividing this by 10 000. For the base layer, multiply this product with the BCF. For asphalt, BSM and cement stabilised layers, multiply with the applicable thickness adjustment factor.

Step 10. Add the layer contributions for each layer to get the PN.

The constants shown in Table C.1 to C.3 and the relationships in Figure C.3 to Figure C.7 were obtained through iterative calibration processes. The values are specific to the PN method and should not be adjusted by the designer.

Table C.1 Stiffness Determination for the Subgrade

Design Equivalent Material Class for Subgrade	Stiffness Value (MPa)
G6 or better	250
G7	140
G8	100
G9	90
G10	70

Note: Subgrade stiffness value should be adjusted for climate (Table C.2) and cover depth (Figure C.3).

Table C.2 Climate Adjustment Factors

Climate	Weinert (N)	Thornthwaite (Im)	Climate Adjustment Factor
Wet	Weinert N < 2	Humid (20 – 100) Perhumid (> 100)	0.6
Moderate	Weinert N = 2 to 5	Dry sub-humid (-20 to 0) Moist sub-humid (0 to 20)	0.9
Dry	Weinert N > 5	Arid (< -40) Semi-arid (-40 to -20)	1.0

Table C.3 Modular Ratio, Maximum Allowed Stiffness and Thickness Limits for Pavement Layers

General Material Description	Material Class ¹	Thickness Limits (mm)	Modular Ratio Limit	Maximum Allowed Stiffness (E _{max})(MPa)	Base Confidence Factor (BCF)
Surface seals	S1, S2, S3, S4, S5, S6	10	2	1000	N/A
Asphalt surfacings	AG, AC, AS, AO	20 – 100	4	2000	1.0
Asphalt bases	BC, BS, BTB	20 – 200	4	1500	1.0
Bitumen Stabilised Material (BSM)	BSM1 ²	100 – 300	3	700	1.0
	BSM2 ³	100 – 300	2.5	600	0.7
Crushed stone material	G1	100 – 150	3	600	1.0
	G2	100 – 200	2	450	0.8
	G3	100 – 200	1.8	400	0.7
Natural Gravel	G4	100 – 300	1.8	375	0.2
	G5	100 – 300	1.8	350	0.1
	G6	100 – 300	1.8	250	-2.0
Gravel-soil blend	G7	100 – 350	1.7	140	-2.5
	G8	100 – 350	1.6	100	-3.0
	G9	100 – 350	1.4	90	-4.0
	G10	100 – 350	1.2	70	-5.0
Cement stabilised natural gravel	C3	100 – 350	4	500	0.6
	C4	100 – 350	3	400	0.4
Equivalent granular (previously cement stabilised)	EG4	100 – 350	2	400	0.4
	EG5	100 – 350	1.8	300	0.2

Notes:

1. Design equivalent material class (DEMAC) for rehabilitation projects.
2. BSM1 parent material is normally using crushed stone or reclaimed asphalt (RA) source material.
3. BSM2 parent material is normally using natural gravel or RA source material.

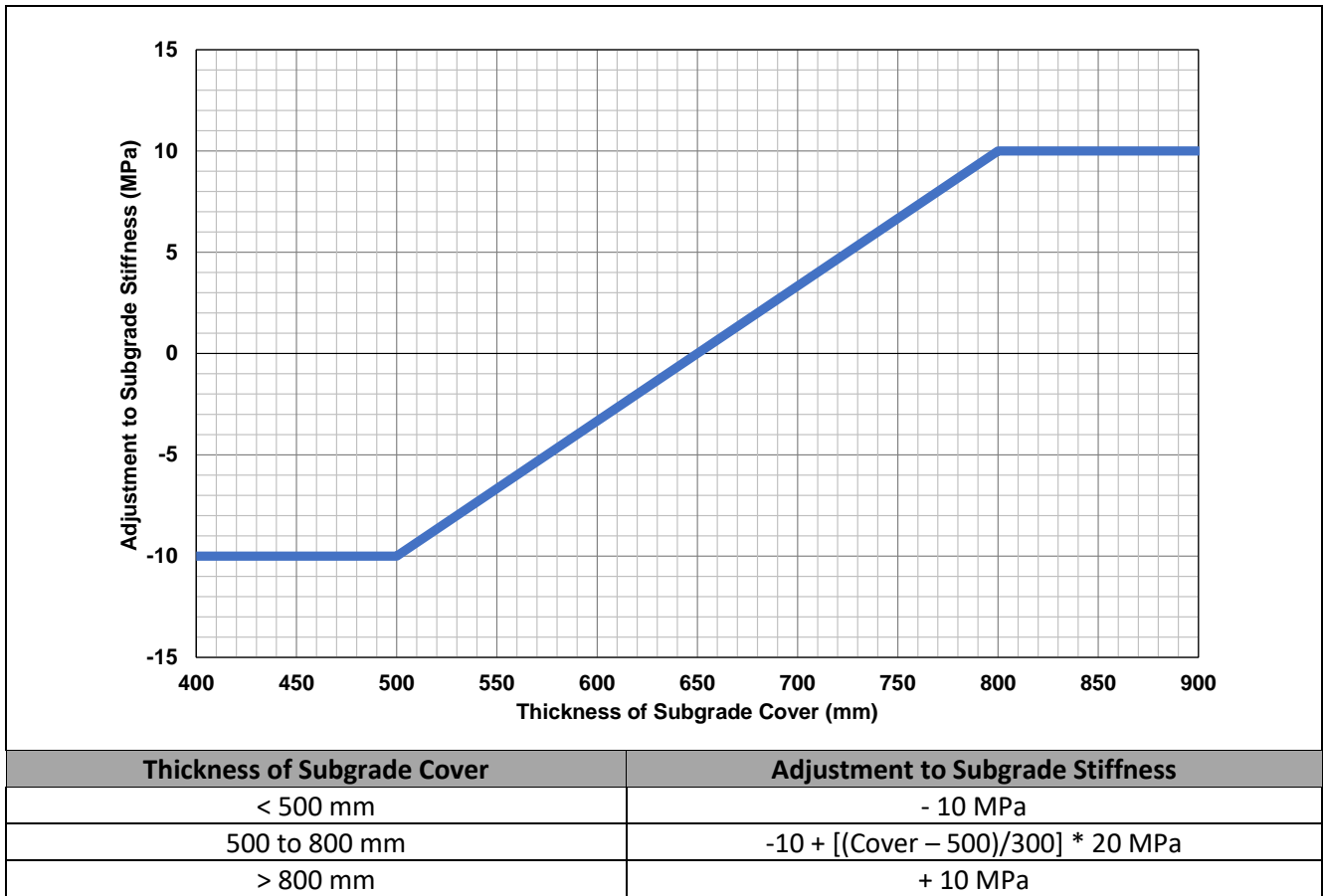

Figure C.3 Adjustment of Subgrade Stiffness Based on Cover Thickness

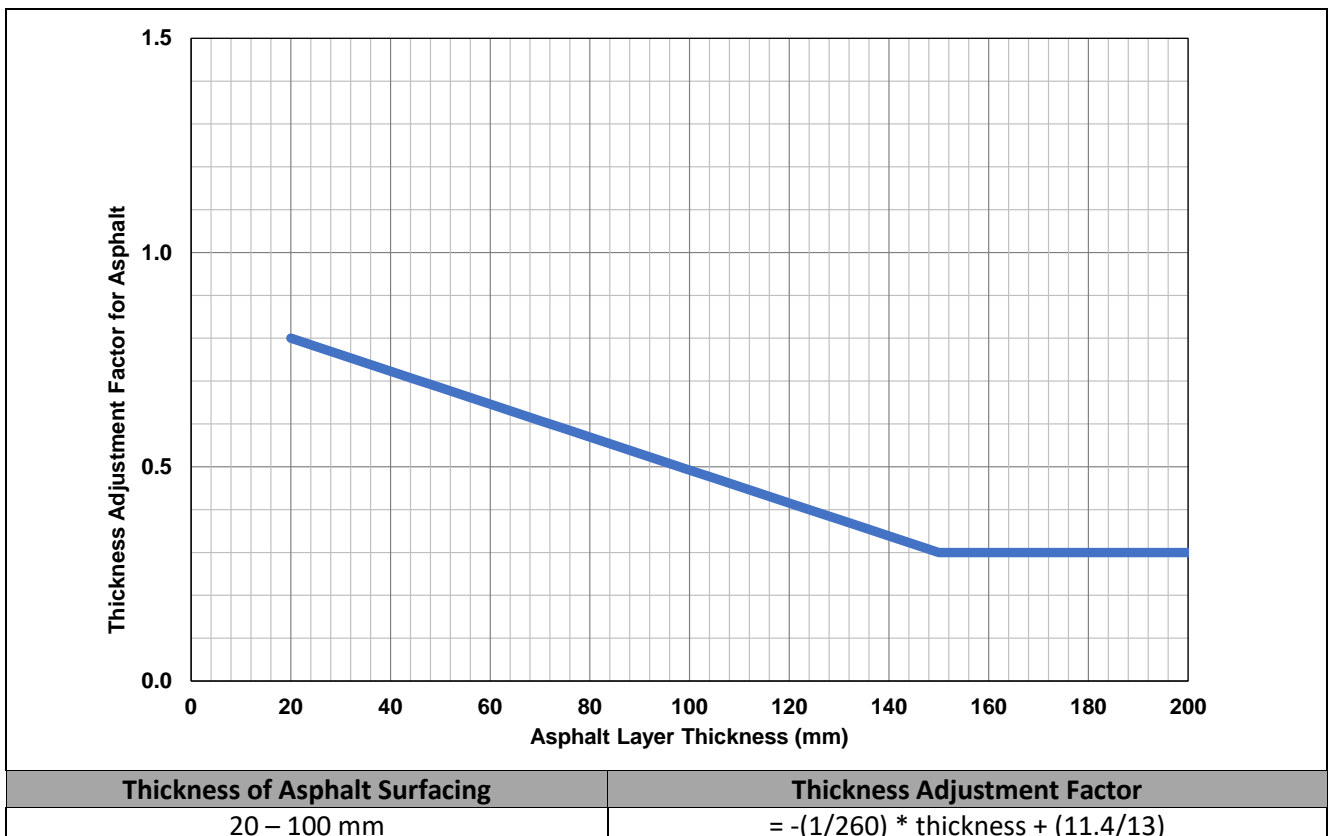

Figure C.4 Thickness Adjustment Factor for Hot-Mix Asphalt Surfacing Layers

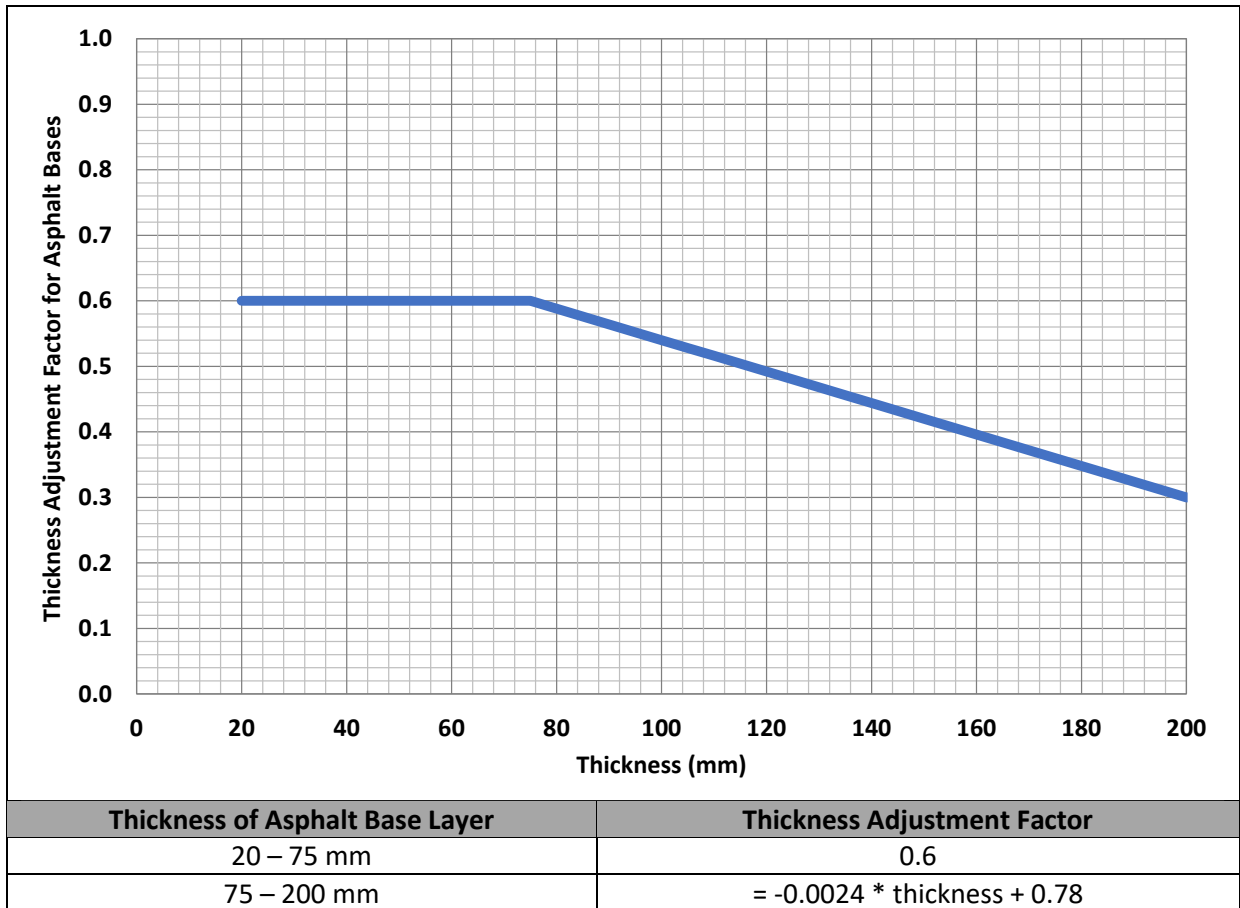

Figure C.5 Thickness Adjustment Factor for Hot Mix Asphalt Base Layers

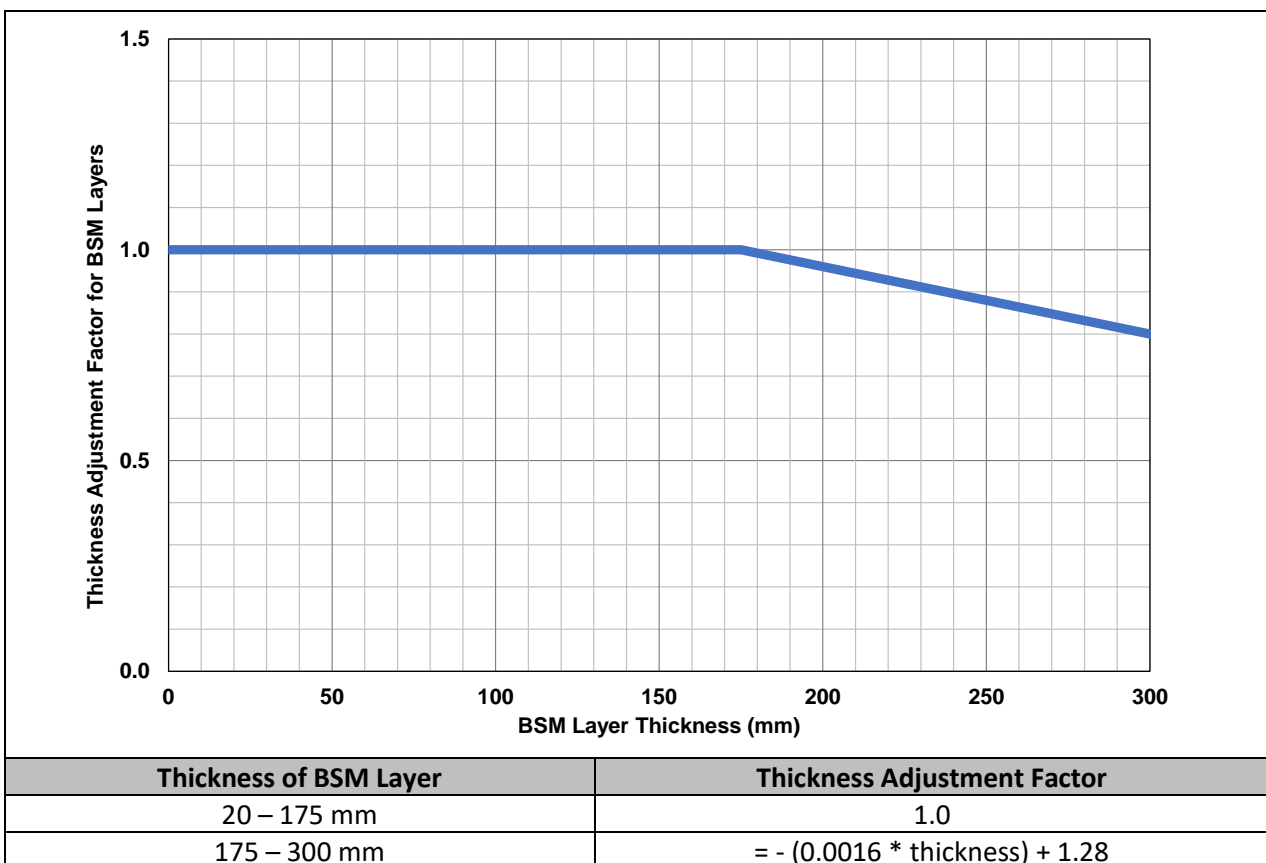

Figure C.6 Thickness Adjustment Factor for BSM Layers

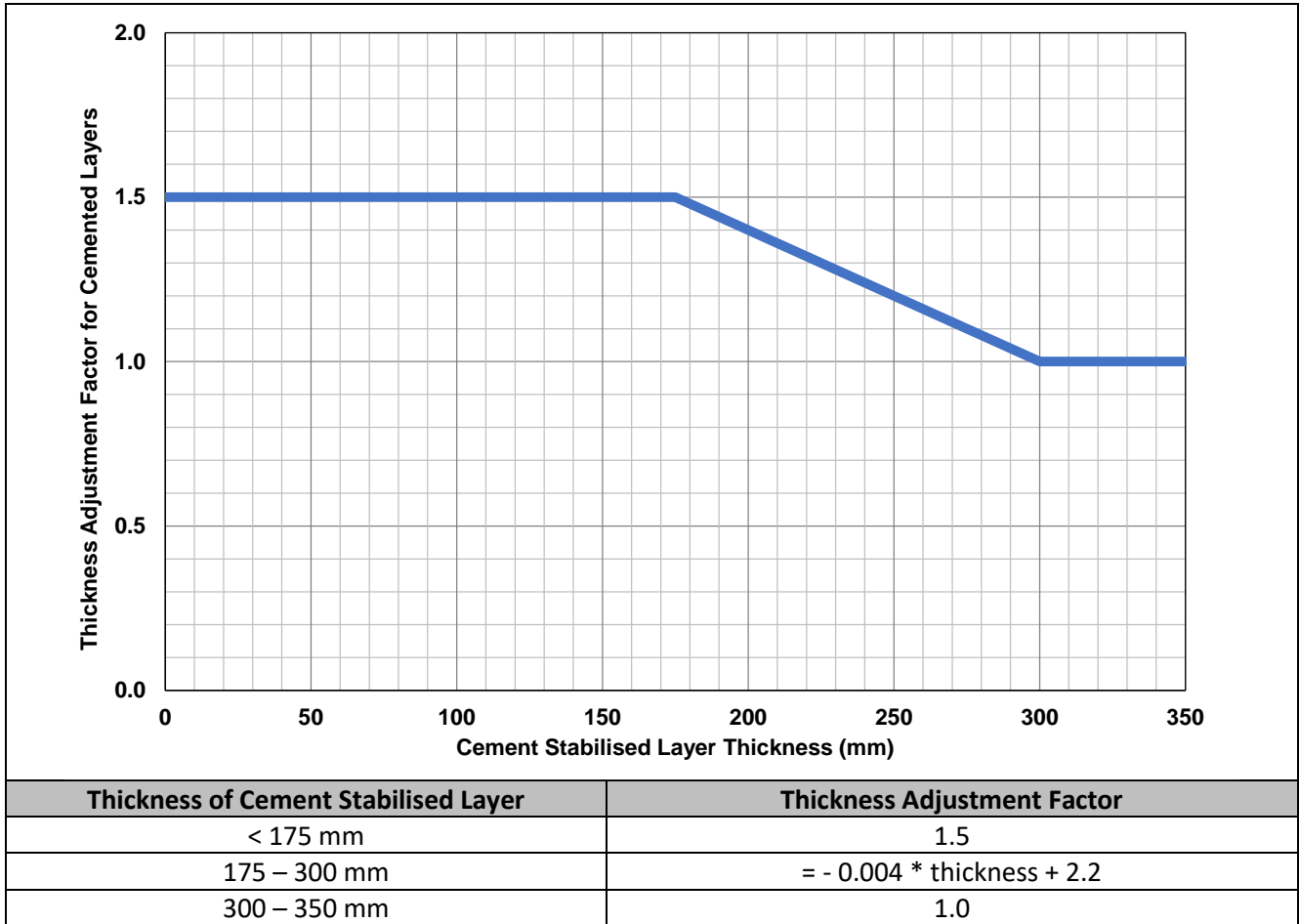

Figure C.7 Thickness Adjustment Factor for Cement Stabilised Layers

C.4.1 Combining Pavement Layers to Form a Five Layer Model

By definition, the PN consists of the sum of the load spreading contributions of four pavement layers above the subgrade. To apply this definition consistently, the pavement model used in the PN calculation must consist of four pavement layers plus the subgrade. In cases where the pavement consists of more than four layers, two or more layers will need to be combined. To do this, the following guidelines should be adhered to:

- Only combine layers that consist of the same general materials class. In this respect, the following general material classes can be used:
 - Hot mix asphalt and surfacing seals
 - Crushed stone material
 - Natural gravel material
 - Cement stabilised material
 - Bitumen stabilised material
 - Gravel-soil, silt or clay materials
- The surfacing should be modelled as a separate layer in all cases. A surface seal should be modelled as a 10 mm thick layer.
- Where there is a need to combine pavement layers, the designer should first combine sub-layers below the subbase, followed (if needed) by sub-layers in the subbase zone.
- The material class assigned to the combined layer should be the class of the thicker of the two layers. Thus, if a 150 mm G6 is combined with a 120 mm G7, then the material assigned to the 270 mm combined layer should be G6.

- Where the two layers to be combined are of equal thickness, the lower material should be assigned to the combined layer. Thus, if a 150 mm G7 is combined with a 150 mm G8, then the material class assigned to the 300 mm combined layer should be G8.
- When a pavement layer is combined with the apparent natural subgrade, the material class of the combined subgrade layer should be the class of the uppermost layer.
- The thickness of the combined layers should not exceed the limits given in Table C.3. These thickness limits are only applicable to the design calculations.

When a pavement consists of only two or three pavement layers, a four layer pavement system should be constructed by subdividing the top of the subgrade into two or more layers, each with a thickness of 150 mm. The material class assigned to these sub-layers should be that of the subgrade.

Figure C.8 shows an example in which there are several selected layers that are combined to form a five layer system. This example also shows the application of the limiting thickness to the selected layers, which also determines the amount of cover on the subgrade for modelling purposes. Even with the above guidelines taken into account, some pavement situations will allow more than one approach to the combination of layers. In such cases, the designer should experiment with different approaches and adopt the most conservative model for design purposes.

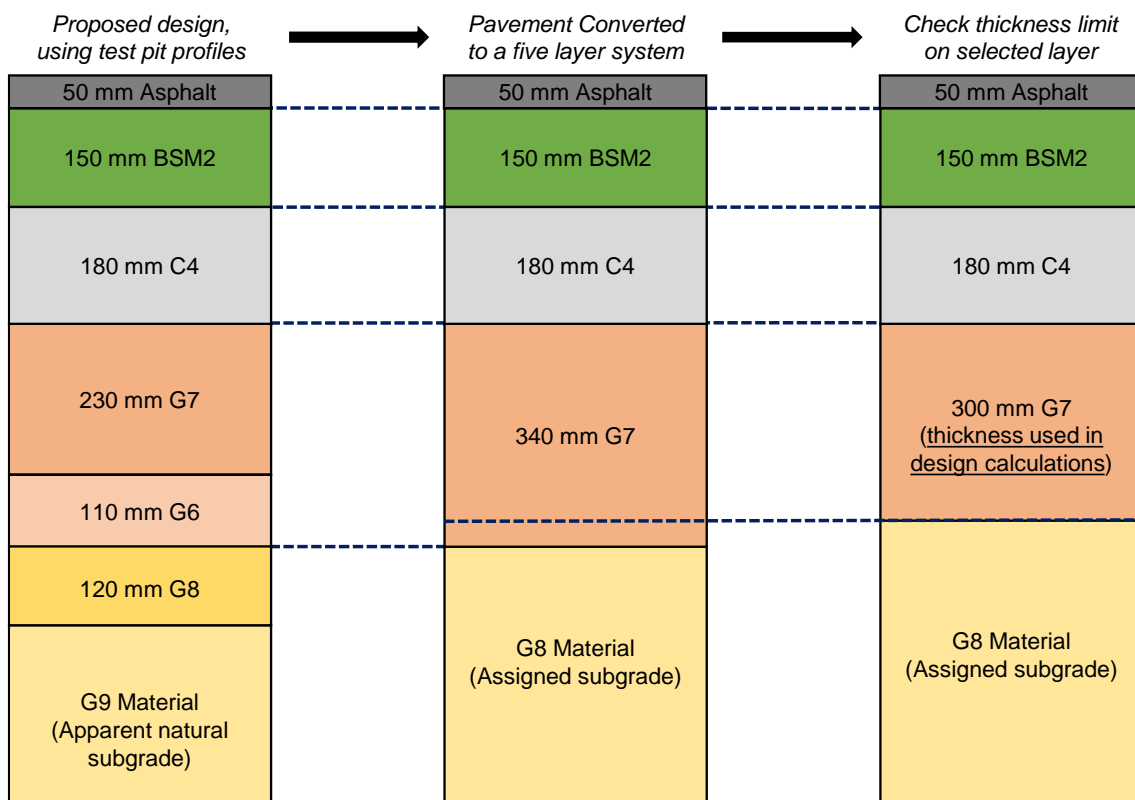

Figure C.8 Example of the Combining of Pavement Layers to Form a Five Layer Model

C.4.2 Determining Effective Long-Term Stiffness (ELTS) Values

The ELTS and Modular Ratio limit are essential to the PN-method. For the subgrade, the ELTS is first determined using the material class. This value is then adjusted for climate and for depth of subgrade cover.

The climate adjustment of the subgrade stiffness takes into account the increased frequency and risk of having a soft subgrade in wet regions. The climate adjustment factors are shown in Table C.2 are multiplied by the ELTS associated with the subgrade material class.

The adjustment for subgrade cover takes into account the behaviour of finer-grained materials which tend to soften under increased stress. A relative adjustment (decrease) of the subgrade stiffness is therefore made to simulate the effect of stress-softening for pavements with less subgrade cover (i.e., where shear stresses are greater). The adjustment of the subgrade stiffness for cover depth is shown in Figure C.3 and is added to or subtracted from the climate adjusted ELTS.

For pavement layers above the subgrade, the maximum allowed stiffness and Modular Ratio limit for each material are obtained from Table C.3 using the assigned material class. The stiffness can then be determined by working from the subgrade upwards, using the Modular Ratio limit and the maximum allowed stiffness. The assigned ELTS is determined as the minimum of the maximum allowed stiffness, and the stiffness of the support layer multiplied by the Modular Ratio limit.

An example of this procedure is shown in Figure C.9 for a structure in a wet and dry climate, respectively. A comparison of these figures shows the impact of climate on the subgrade, and the subsequent impact on the stiffness of each pavement layer. These examples show how the Modular Ratio effectively takes into account the stiffness of the support layer, thereby reducing the assigned ELTS when the support stiffness reduces, even though the material class remains unchanged.

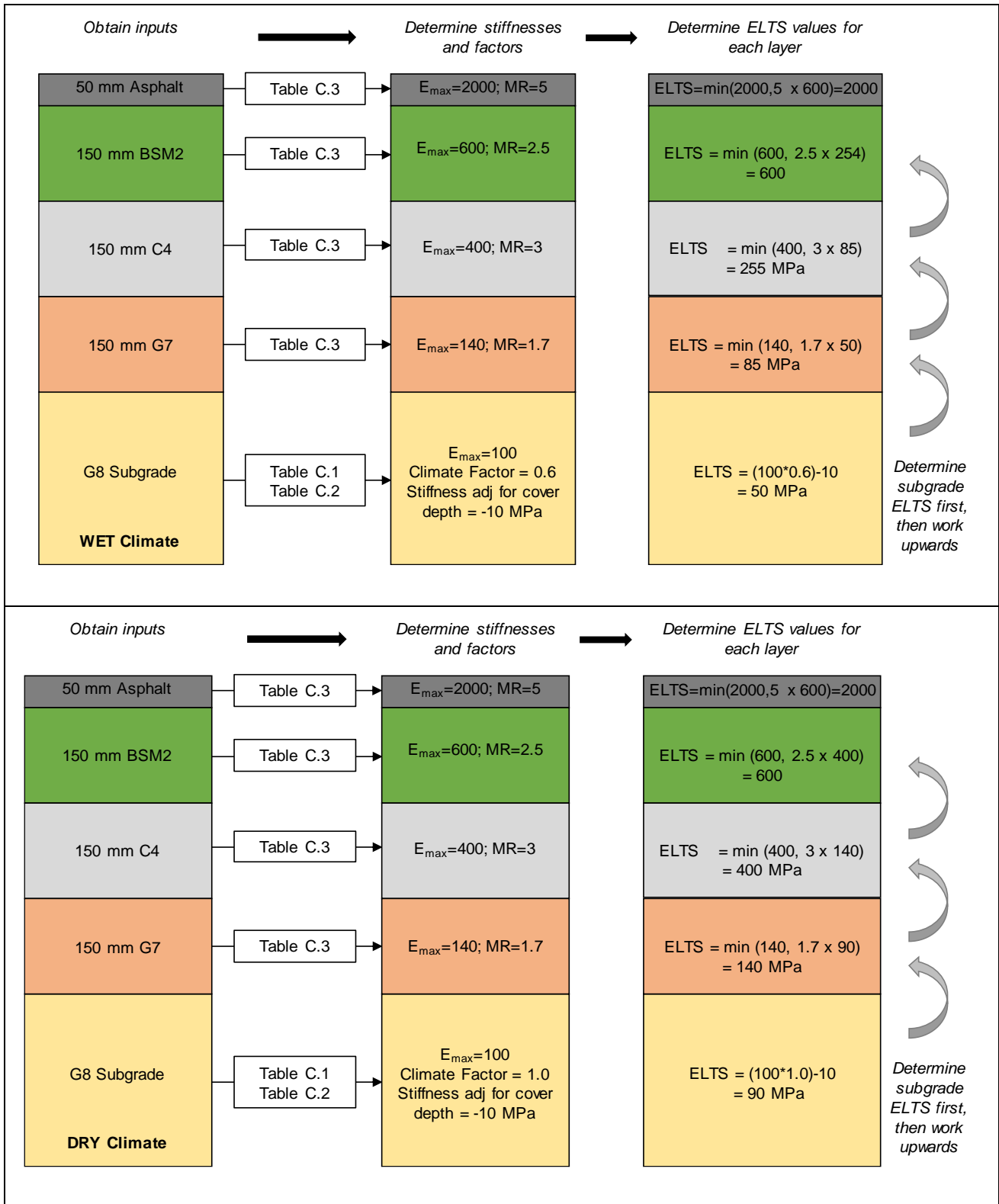

Figure C.9 Example of ELTS Determination for Dry and Wet Climates

C.5 PAVEMENT CAPACITY CALCULATION

The calculation of the pavement capacity depends on the Pavement Number and the Road Category. The relationship and constants in Table C.4 are used. The relationship between the PN and the pavement capacity does not give a pavement life prediction, but rather provides a lower limit for which the pavement should be capable of carrying the anticipated traffic.

The criteria are only applicable to Category A and B roads, and for design capacities less than 40 MESA.

Table C.4 Pavement Capacity Calculation for Pavement Number

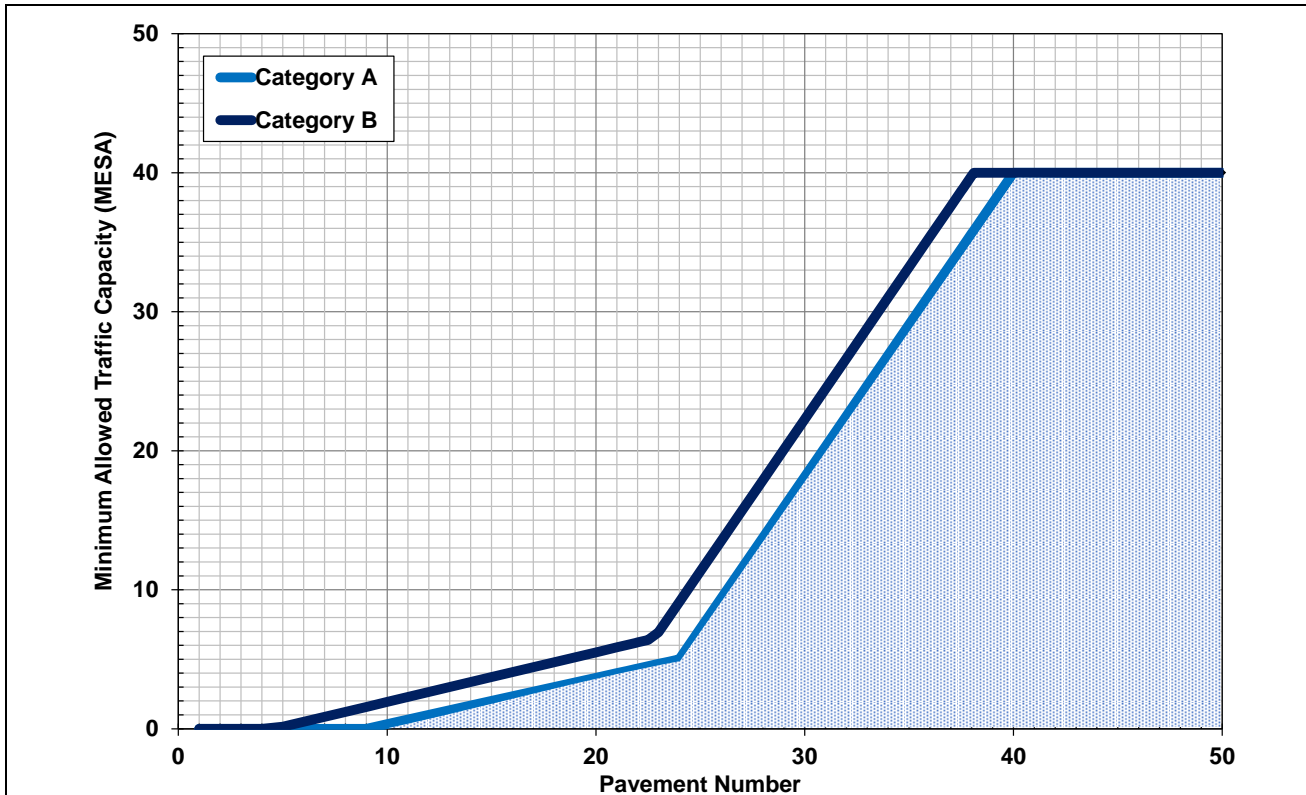

$$N_{allow} = N_1 + PN * Slope$$

Where: N_{allow} = Minimum Allowed Pavement Capacity (million equivalent standard axles, MESA)
 N_1 = Intercept for line segment, from constants below
 PN = Calculated Pavement Number
 Slope = Slope for the line segment, from constants below

	Pavement Number	N_1	Slope
Category A	< 9	Not suitable	
	9 to 24	-3.0	1/3
	24 to 40	-47.5	2.1875
	> 40	40	0
Category B	Pavement Number	N_1	Slope
	< 4.6	Not suitable	
	4.6 to 22.8	-1.6429	0.3571
	22.8 to 38.1	-43.4216	2.1895
> 38.1	40	0	

C.6 WORKED EXAMPLE

A pavement structure in a moderate climate has come to the end of its design life and requires rehabilitation. The structure includes a thick fatigued asphalt surfacing with crocodile cracking on a G2 quality base layer, on a previously stabilised cemented layer that is now in an equivalent granular state. The entire pavement profile is shown as “Existing Road” in Figure C.10. It serves as a Category A facility and thus needs to be designed for 95% reliability.

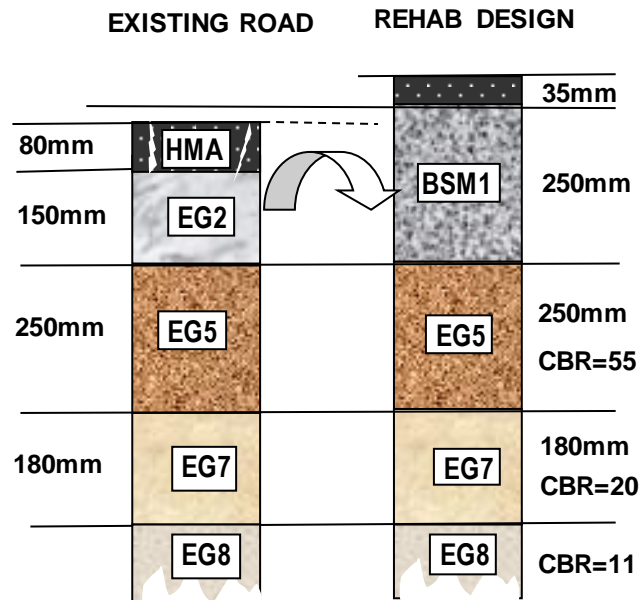

Figure C.10 Existing Pavement and Proposed Rehabilitation Design

The rehabilitation strategy includes Cold In Place Recycling of the existing cracked asphalt together with the G2 base. It includes bitumen stabilisation of the blend of reclaimed asphalt (RA) and granular materials. The existing G5 subbase and G7 selected subbase have suffered moderate permanent deformation but do not require any interventions as part of the rehabilitation process.

There are three components to the design process, namely:

- i. Structural design using the pavement number PN method
- ii. Mix design process
- iii. Final design based on mechanistic empirical analysis, using the “Stellenbosch BSM Design Function”

For the purpose of demonstrating the structural design process, a thickness of 250 mm of Bitumen Stabilised Material with foamed bitumen (BSM-foam) has been selected. In reality, a sensitivity analysis of different design thicknesses would be used to identify the BSM layer thickness that provides adequate structural capacity. In this case, it is convenient to blend two complete layers with a combined thickness of 230 mm, as well as added binder and active filler. The materials will bulk after pulverisation, and after adequate compaction (100% of MDD), the BSM base will comfortably provide a finished layer 250 mm thick.

C.6.1 Mix Design Results

A mix design for BSM technology was carried out using samples of RA and G2 retrieved using appropriate sampling techniques (Section 3.4) from the existing pavement. The blending ratios by mass are based on the dry

bulk density of each layer in combination with the respective layer thicknesses of the two materials. The calculation is as follows:

$$\begin{aligned}
 \text{RA:} & \quad 2450 \text{ kg/m}^3 \text{ BRD} \times 0.08 \text{ m thickness} \times 1 \text{ m}^2 = 196 \text{ kg} \\
 \text{G2:} & \quad 2275 \text{ kg/m}^3 \text{ MDD} \times 0.15 \text{ m thickness} \times 1 \text{ m}^2 = 341.25 \text{ kg} \\
 \text{Blending ratio:} & \quad \text{RA:G2} = 196:341.25 = 1:1.74
 \end{aligned}$$

The mix design, as outlined in Chapter 4, yielded the results shown in Table C.5.

Table C.5 BSM-Foam Mix Design Results

Test	Result	
Maximum Dry Density at 100% Modified AASHTO compaction	2275 kg/m ³	
Foamed bitumen Addition	2.2%	
Amount of active Filler (Cement)	1%	
Indirect Tensile Test (ITS)	ITS _{DRY}	235 kPa
	ITS _{WET}	145 kPa
Triaxial Testing	Friction Angle	40.0°
	Cohesion	250 kPa
	Retained Cohesion	75%
Bitumen Stabilised Material Classification	BSM 1	

C.6.2 Pavement Number Design

An example of the PN calculation is shown in Figure C.11. In the figure, the assumed values are shown in green, values obtained from tables and figures are shown in purple, and calculated values in red and brown.

For the example, the following information was assumed:

- Climate: Moderate
- Pavement Structure: 35 mm Asphalt Surfacing
 250 mm BSM1 (Bitumen stabilised crushed stone and RA blend)
 250 mm EG5 (Gravel soil blend)
 180 mm G7 Selected layer
 G8 Subgrade

Step 1. Check the number of pavement layers and thicknesses

The pavement has five layers including the subgrade, and does not need adjustment using the guidelines in Section C.4.1. The layer thicknesses are within the specified limits for each material type given in Table C.3.

Step 2. Calculate the Subgrade ELTS

This is shown in the topmost section of Figure C.11. The initial stiffness of the subgrade is first determined from Table C.1 using the material class, multiplied by the climate adjustment factor (Table C.2) and then the cover depth adjustment factor (using Figure C.3) is added. For this example, the initial stiffness is 100 MPa for a G8 and the climate adjustment factor is 0.9 for a moderate climate. The cover depth is 715 mm, which gives a cover adjustment of 4.33 (Figure C.3).

The subgrade ELTS is $100 \times 0.9 + 4.33 = 94.33$.

The subgrade ELTS is then entered into the last row of column 6 of the lower table in Figure C.11.

Step 3. Calculate the ELTS for each layer

The Modular Ratio limit and maximum allowed stiffness are determined from Table C.3 and entered into Columns 4 and 5 in Figure C.11. The ELTS is then calculated as the minimum of:

- The maximum allowed stiffness.
- The stiffness of the support layer multiplied by the Modular Ratio limit.

The calculation starts at the subgrade and then moves upward. For example, the ELTS of the G7 selected layer is the minimum of 160.4 (i.e., 94.33 * 1.7) and the maximum allowed stiffness of 140 MPa. The ELTS is, thus, 140 MPa.

Step 4. Determine the Thickness Adjustment Factors and Base Confidence Factor

The thickness adjustment factors for asphalt and BSM layers are determined from Figure C.4 (asphalt surfacing) and Figure C.6 (BSM) and entered in column 7. In this example, this factor applies only to these materials. The thickness adjustment factor for the asphalt layer is 0.742 and for the BSM layer 0.88.

Step 5. Determine the Base Confidence Factor

The base confidence factor BCF for the base layer is determined from Table C.3 and is only valid for the base layer. The BCF for the BSM1 base is 1.0.

Step 6. Calculate Layer Contribution

The layer contribution in column 9 is calculated for each layer by multiplying the thickness, the ELTS, the thickness adjustment factor and the BCF (where applicable), i.e., Columns 2, 6, 7 and 8. This product is then divided by 10 000 to scale the number to a realistic value. For example, the base layer contribution is:

$$(250 * 700 * 0.88 * 1.0) / 10\ 000 = 15.4.$$

Step 7. Calculate the Pavement Number

The layer contributions are added to obtain the PN. For this example:

$$PN = 5.2 + 15.4 + 6.3 + 2.5 = 29.4$$

Step 8. Determine the Pavement Capacity

The pavement capacity is calculated using the equations in Table C.4, using the constants given. For this example, the pavement capacity is:

$$\text{Category A: } -47.5 + 29.4 * 2.1875 = 16.8 \text{ MESA}$$

$$\text{Category B: } -43.4216 + 29.4 * 2.1895 = 21.0 \text{ MESA}$$

For this worked example, the pavement life is a minimum of 16.8 MESA for Category A and 21.0 MESA for Category B.

Subgrade Class	G8	
Initial Stiffness	100 MPa	(from Table C.1)
Climate	Moderate	
Climate Adjustment	0.9	(from Table C.2)
Cover Depth	715 mm	(sum of layer thicknesses above subgrade)
Cover Adjustment	4.33	(from Figure C.3)
Subgrade ELTS	94.33	$100 * 0.9 + 44.33 = 94.33$

Col. 1	Col. 2	Col. 3	Col. 4	Col. 5	Col. 6	Col. 7	Col. 8	Col. 9	
Layer	Thickness (mm)	Material Class	Modular Ratio (Table C.3)	Maximum Allowed Stiffness (MPa) (Table C.3)	ELTS (MPa)	Thickness Adjustment	BCF (Table C.3)	Layer Contribution	
Surfacing	35	AC	4	2000	2000	0.742 (Figure C.4)	n/a	5.2	
Base	250	BSM1	3	700	700	0.880 (Figure C.6)	1.0	15.4	
Subbase	250	EG5	1.8	300	252	n/a	n/a	6.3	
Selected	180	G7	1.7	140	140	n/a	n/a	2.5	
Subgrade		G8		100	94.33	Pavement Number =		29.4	
								Pavement Capacity =	16.8 Cat A 21.0 Cat B

Figure C.11 Example Showing Determination of the Pavement Number

C.6.3 Mechanistic-Empirical Design

The Stellenbosch BSM Design Function introduced in Chapter 5 is employed for the mechanistic empirical design for the pavement rehabilitation.

Falling Weight Deflectometer FWD data from the existing road were backcalculated to develop stiffness values for the existing pavement layers. The results in Table C.6 were achieved and adjusted according to limiting Modular Ratios.

Table C.6 Worked Example Pavement Structure and Inputs

Pavement Layer	Material Class	Thickness (mm)	Modular Ratio	Maximum Resilient Modulus (MPa)	Back-calculated Resilient Modulus (MPa)	Design Resilient Modulus ¹ (MPa)
Surfacing	Asphalt	35	5	2500		2500
Base	BSM 1	250	3	1000 ²		780
Subbase	EG5	250	1.8	300 ³	260	260
Selected Subgrade	G7	180	1.7	200	150	150
Subgrade	G8	N/A	1.6	100	95	95

Notes:

1. Design resilient modulus is guided by the typical values in SAPEM, as well as from backcalculation from FWD data (see Chapter 3) and governed by the Modular Ratio and the maximum allowed resilient modulus (see Chapter 5, Table 5.2).
2. Maximum Resilient Modulus (Max Mr) for BSM1 over granular from Chapter 5.
3. Resilient moduli values from SAPEM Chapter 10 Table 29 (2014).

Designing for a Category A road in a moderate climate with a BSM1 base provides for the following design coefficients to be applied to the Stellenbosch BSM Design Function:

- A terminal condition of 10 mm rutting in the BSM for a Category A road is built into the design function.
- Retained Cohesion: RetC = 75% (default, confirmed with mix design)
- Percentage of MDD (Modified AASHTO Density) from specification: $P_{MDD} = 100\%$
- Mechanistic analysis using layered elastic theory determines the major and minor principle stresses, σ_1 and σ_3 . These are calculated at a depth of $\frac{1}{4}$ of the BSM layer thickness. Using σ_1 and σ_3 , and the cohesion (C) and friction angle (ϕ) from the mix design (Table C.5), the deviator stress ratio (Chapter 5, Section 5.1.2.6 (i)) is calculated.

The life of the BSM layer is determined using the Stellenbosch Design Function:

$$\log N = A - 57.286(DSR)^3 + 0.0009159(P_{MDD} \cdot RetC)$$

Where:

- N = Number of axle repetitions to reach a set rut depth
- A = Reliability Coefficient linked to Road Category (see table)

Reliability	Road Category	A	Rut Limit (mm)
95%	A	1.71113	10
90%	B	1.79873	15
80%	C	1.88733	20
50%	D	2.00443	25

- DSR = Deviator Stress Ratio, as a fraction
- P_{MDD} = BSM dry density expressed as a percentage of MDD (%)
- $RetC$ = Retained Cohesion (%)

The mechanistic empirical design is carried out for an 80 kN axle evenly distributed over dual wheels. The mechanistic analysis details are provided in Figure C.12. It should be noted that some software packages show instability in the stress and strain analysis at the interface between layers.

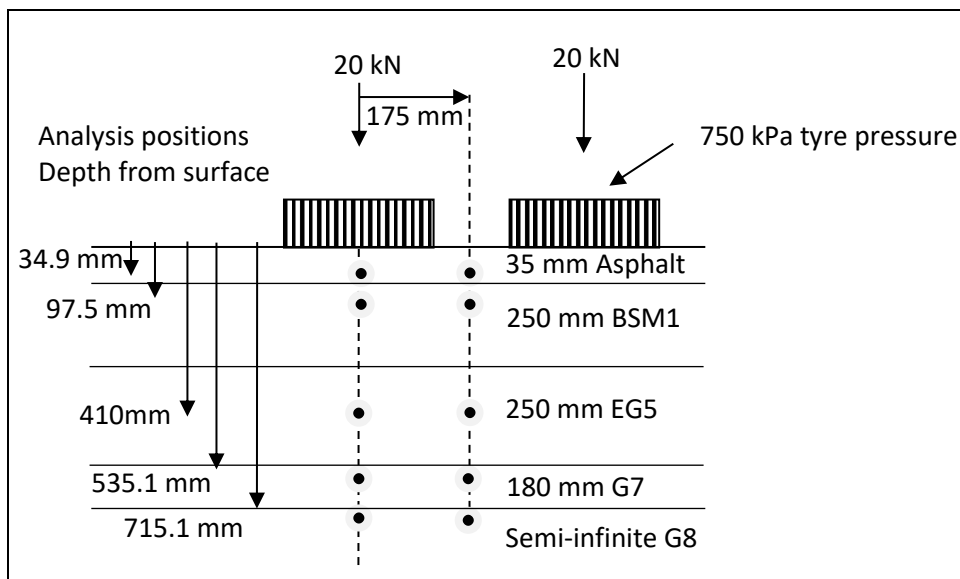

Figure C.12 Mechanistic-Empirical Design Details and Analysis Positions

The solution is to select an analysis point at a slight offset from the interface, e.g., 0.1 mm, as used in this example.

The South African Mechanistic Design Method SAMDM (SAPEM, 2014) and the Stellenbosch BSM Design Function are used for the mechanistic empirical analysis. Critical performance parameters for each layer are analysed and used as input into the relevant transfer functions to calculate the pavement layers' life in Million Equivalent Standard Axles (MESAs (80 kN). Note that the adjustment to eliminate tensile stresses specified for granular materials is not recommended for the Stellenbosch BSM Design Function.

C.6.3.1 Single BSM Layer Design Approach

Two approaches are detailed below. Firstly, the BSM layer is analysed as a single layer, and secondly as two sublayers. A Modular Ratio of 3 has been adopted in this example, resulting in a design life of **12 MESAs** based on BSM1 base deformation in the Stellenbosch BSM Design Function, as summarized in Table C.7.

Table C.7 Single BSM Layer Design Approach

Pavement Layer	Thickness (mm) and Material Class	Resilient Modulus (MPa) and Poisson's Ratio	Material Inputs	Stresses and Strains from Software ^{1,2}		Pavement Life (MESA) ³
				Under Wheel	Between Wheels ¹	
Surfacing	35 Asphalt	2500 0.4		$\epsilon_h = -103.8 \mu\epsilon$	$\epsilon_h = 10.4 \mu\epsilon$	12.1 ⁴
Base	250 BSM1	780 0.35	C=250 $\phi=40$ RetC=75 $P_{MDD}=100$	$\sigma_1=404.1$ $\sigma_3=41.2$ DSR=0.297	$\sigma_1=135$ $\sigma_3=20$	11.9
Subbase	250 EG5	260 0.35	C term=100 ϕ term=2.8	$\sigma_1=40.5$ $\sigma_3=-12.7$	$\sigma_1=41.2$ $\sigma_3=-13.6$ F=1.83	>100
Selected Subgrade	180 G7	150 0.35		$\epsilon_v=183 \mu\epsilon$	$\epsilon_v=200 \mu\epsilon$	>100
Subgrade	Semi-infinite G8	95 0.35		$\epsilon_v=1712 \mu\epsilon$	$\epsilon_v=184 \mu\epsilon$	>100

Notes:

1. The load applied was 20 kN on dual wheels with 750 kPa tyre pressure, spaced 350 mm apart.
2. Negative denotes tension. Note that no adjustment is made to remove the tensile stress as is done with granular materials (Theyse, 1996).
3. Although the asphalt surfacing is included in the analysis, the layer forms part of the life cycle strategy for maintenance within the structural design period (SDP). The asphalt layer life provides an indication of its lifespan. However, if the asphalt is the critical layer in the pavement structure, i.e., lowest N, it does not determine the pavement's capacity, provided a reasonable surfacing life is attained (typically equivalent to 8 to 12 years). The asphalt layer will merely be milled off and replaced within the SDP.
4. The following transfer functions were used to calculate the pavement life:
 - Asphalt: Continuously graded asphalt surfacing
 - BSM: Stellenbosch BSM
 - EG5: Granular materials
 - G7, G8: Subgrade materials (10 mm rutting)

The default BSM shear parameters have been applied in these calculations. If the actual mix design results yielded a cohesion value of 260 kPa instead of 250 kPa, this would extend the **BSM life** by more than 30% from **12** to **16 MESAs**.

C.6.3.2 Sub-layered BSM Design Approach

Guidelines for sub-layering a BSM layer are given in Chapter 5, Section 1.2. By comparison, a designer who sub-layers the BSM1 into to 125 mm layers, with the upper layer resilient modulus increased to 1000 MPa will evaluate an estimated design life of **16.7 MESAs**, as shown in Table C.8. Notice that the BSM layer remains the critical layer in the pavement structure.

Table C.8 Sublayer Design Approach (for BSM)

Pavement Layer	Thickness (mm) and Material Class	Resilient Modulus (mm)	Material Inputs	Stresses and Strains from Software ¹		Pavement Life (MESA)
				Under Wheel	Between Wheels	
Surfacing	35 Asphalt	2500 0.4		$\epsilon_h = -69.1 \mu\epsilon$	$\epsilon_h = +24.4 \mu\epsilon$	96.87
Base	125 BSM 1 Upper	1000 0.35	C=250 $\phi=40$ RetC=75 $P_{MDD}=100$	$\sigma_1 = 545.5$ $\sigma_3 = 116.8$ DSR = 0.287	$\sigma_1 = 167.5$ $\sigma_3 = 48.6$	16.7
	125 BSM 1 Lower	780 0.35	C=250 $\phi=40$ RetC=75 $P_{MDD}=100$	$\sigma_1 = 153$ $\sigma_3 = -36.8$ DSR = 0.202	$\sigma_1 = 88.7$ $\sigma_3 = -38.8$	
Subbase	250 EG5	260 0.35	C term=100 ϕ term=2.81	$\sigma_1 = 37.5$ $\sigma_3 = -12.6$	$\sigma_1 = 39.6$ $\sigma_3 = -13.5$ F=2.182	>100
Selected Subgrade	180 G7	150 0.35		$\epsilon_v = 178 \mu\epsilon$	$\epsilon_v = 194 \mu\epsilon$	>100
Subgrade	G8	95 0.35		$\epsilon_v = 167 \mu\epsilon$	$\epsilon_v = 179 \mu\epsilon$	>100

Note:

1. Negative denotes tension

C.6.3.3 Lessons Learnt from BSM Mechanistic-Empirical Design

Several lessons can be learned from this BSM ME design exercise:

- Design approaches based on material characteristics, such as Modular Ratio, are useful and can provide a reality check of layer stiffness limits. However, the technique should not be blindly applied. Be cognisant of material quality and in-service pavement conditions.
- The stiffness of the base layer contributes significantly to the life of the asphalt surfacing. In this case the design shows parity in BSM life by sub-layering and increasing the upper BSM base stiffness. This can change with different supporting layers in the structure.
- The inclusion of a cemented subbase would be conducive to improved performance of the BSM base, by providing a platform for improved compaction, resulting in a higher density and consequently a higher resilient modulus value.
- Structural design is not deterministic, it is stochastic and deals with variability. At best, the design life should be considered to fall within a range. In this case the integrity of the EG5 subbase should be confirmed, as the BSM 1 base stiffness is critically dependent on the supporting layers (using Modular Ratios).
- PN Design is recommended for the first attempt at pavement design, as it assists with the mix design process for BSMs, particularly with identifying layer thicknesses and the need for blending (see Chapter 3). The designer can use both the PN method and ME design method. This assists in the refinement of the final design. As the worked example shows, the two design methods will invariably yield at least slightly different design lives, which provides the designer with some sensitivity insights before final decision making.

REFERENCES

- JENKINS K.J., Collings D.C., Johns F.M., Hefer A.W and Greyling A.H. 2019. **TG2 (2019) Removes Barriers and Elevates the Performance of Bitumen Stabilised Materials (BSMs)**. 12th Conference on Asphalt Pavements for southern Africa (CAPSA). Sun City. 2019.
- JOHNS, F.M, and Hefer, A.W 2019. **Revision of the Pavement Number Pavement Design Method and the DEMAC Material Classification System**. Technical Report. Rubicon Solutions, Johannesburg, South Africa.
- JOOSTE, F.J, Long, F.M. and Hefer, A.W. 2007. **A Method for Consistent Classification of Materials for Pavement Rehabilitation Design**. Technical Memorandum. Modelling and Analysis Systems, Cullinan, South Africa (study funded by Sabita and Gauteng Department of Public Transport, Roads and Works). (Gautrans report: CSIR/BE/IE/ER/2007/0005/B).
- JOOSTE, F.J., F.M. Long and A.W. Hefer. 2007. **A Knowledge Based Structural Design Method for Pavements Incorporating Bitumen Stabilised Materials**. Technical Memorandum. Modelling and Analysis Systems, Cullinan, South Africa. SABITA/Gauteng Department of Public Transport, Roads and Works, Pretoria, 2007. (GDPTW report number: CSIR/BE/IE/ER/2007/0004/B).
- LONG, F.M. and F.J. Jooste. 2007. **Summary of LTP Bitumen Emulsion and Foamed Bitumen Treated Sections**. Technical Memorandum. Modelling and Analysis Systems, Cullinan, South Africa. SABITA/Gauteng Department of Public Transport, Roads and Works, Pretoria, 2007. (GDPTW report number: CSIR/BE/IE/ER/2007/0006/B).
- SAPEM. 2014. **South African Pavement Engineering Manual**. South African National Roads Agency SOC Ltd. ISBN 978-1-920611-00-2
- Technical Recommendations for Highways, 1996, **Structural Design of Flexible Pavements for Interurban and Rural Roads, TRH4**, Draft, 1996.
- Technical Recommendations for Highways, 1997, **Flexible pavement rehabilitation investigation and design, TRH12**, Draft, 1997.
- THEYSE, H.L., De Beer, M. and Rust, F.C. 1996. **Overview of the South African Mechanistic Pavement Design Analysis Method**. Paper Number 961294 Presented at the 75th Annual Transportation Research Board Meeting, January 7 to 11, 1996, Washington, D.C.

APPENDIX D: QUALITY CONTROL

D.1	PROCESS CONTROL FOR IN SITU RECYCLING PROJECTS	198
D.2	PROCESS CONTROL FOR IN PLANT MIXING PROJECTS.....	200
D.3	ACCEPTANCE CONTROL FOR ALL RECYCLING PROJECTS.....	203
D.4	OBTAINING CORE SPECIMENS FOR TESTING	206

This Appendix explains the observations, tests and measurements that are necessary to ensure that the quality of the newly completed pavement layer meets the specified end product requirements. In addition, certain measurement and payment items require strict controls to be applied during the course of the work, especially those concerned with the application of active filler and bitumen stabilising agents that represent a large proportion of the total cost of the work.

Many of the standard tests that are routinely used for new construction cannot be applied on recycling projects due to the type and variable nature of material that is recycled. Consumption controls are required since it is practically impossible to accurately determine the amount of additive applied by testing the treated material. Such controls, together with the observations, tests and measurements that are necessary to ensure the quality of the final product are discussed in this Appendix.

Quality control is an ongoing process that is tackled in two distinct phases. "Process Controls" are applied whilst the work proceeds to ensure that the various operations / processes are being carried out correctly. Once the work is complete, the finished layer is then tested for acceptance. Such "Acceptance Controls" are focused on ensuring that the final product meets the specified requirements on which the pavement design is based.

Process Controls for in situ recycling are different from those applicable to in plant mixed material and are, therefore, covered under separate sections. Acceptance Controls for the completed work are common to both and are included under one section.

D.1 PROCESS CONTROL FOR IN SITU RECYCLING PROJECTS

The various checks, tests and measurements that need to be carried out to ensure that the final product will meet the requirements fall under the heading of Process Control and are summarised below.

D.1.1 Preliminary Requirements

- Compile and print out the cut plan(s) for all sections that are about to be recycled. This must include spraybar settings for the overlaps between adjacent cuts.
- Define the work that is about to be undertaken:
 - The section of road that is to be recycled, for example, km 6+320 to km 7+000, Left half-width.
 - All pre-work requirements, for example, cement spreading.
 - Details of cut lengths to be recycled before reversing the train, for example, 280 m / 400 m.
 - Cut sequence, for example, first cut: left outer / second cut: left inner.
 - Depth of cut, for example, 200 mm constant for both cuts.
 - Application rates for stabilising agents, for example, 2.1% foamed bitumen + 1% cement.
 - Density of the material in the completed layer. This is the average MDD of the material that will be recycled, determined in the laboratory from the moisture / density relationship test, such as 2100 kg/m³.
- Determination of the minimum number of samples to be taken for laboratory testing and each sampling location (see Paragraph D.3.1 below).

These details are entered on the Supervisor's Daily Report Sheet before he leaves for site.

D.1.2 Requirements on Site before the Work Begins

- Complete the pre-start checks (explained in Chapter 6).
- Ensure that the survey references have been established and checked.
- Check that the operator's guideline has been correctly positioned (for each cut).
- Carry out the necessary measurements / tests to determine the accuracy of cement / lime spreading.
- Ensure that a sample of the untreated material is obtained.

Where bitumen emulsion is to be added, the following additional checks are to be carried out on a sample drawn from the tanker before it is coupled into the train. (These tests are normally included in the Pre-start Check List for the project):

- Determine the pH using litmus paper. This will confirm whether the emulsion is anionic (alkaline) or cationic (acidic).
- Check the breaking rate of the emulsion (following the simple test procedure described in Appendix B, *BSM2 Laboratory Mix Design of Bitumen Stabilised Material, Section 6.3.6.3*).

Where foamed bitumen is to be added, the quality of foam produced is checked using the test nozzle (visual check).

D.1.3 Process Controls while the Recycling Work is being Carried Out

General ongoing checks and observations:

- The computer input data and spraybar settings are correct (for each cut).
- The operator is adhering to the guideline (correct line of cut).
- The speed of advance is within the prescribed range (± 8 m/min).
- The depth of cut is correct (checked by probing at least twice every 100 m).
- Spraybar operating pressures are sufficient.
- The rear tyres of the recycler are free of material build-up.

The following tests / observations are undertaken on the material exiting the mixing chamber:

- Visual appearance (consistency across the width of cut and the quality of mix).
- The temperature across the width of cut is consistent (<3 °C variation).
- The moisture content is appropriate (i.e. approximately 75% of OMC, determined by “feel”).
- Samples of the mixed material for Acceptance Control tests are taken at the required locations (see Section D3.3.1) and properly preserved until being transported to the laboratory (within the time limitations).

Checks on the primary compaction process behind the recycler:

- The edge of cut is regularly exposed (every ± 5 m) to ensure that the roller is working within the cut limits.
- Where fitted, the Intelligent Compaction system is functioning correctly.
- The roller is consistently moving at the correct speed of advance (< 3 km/hr).
- Sufficient passes are made on each section being compacted.
- Proximity to the recycler (sufficiently close).

D.1.4 Determining the Consumption of Active Filler and Bitumen Stabilising Agents (measurement item)

- Bituminous stabilising agents

As soon as the recycling work is complete, the theoretical consumption can be calculated and reconciled with the amount actually used (data taken from the recycler’s computer) as well as the mass shown on the tanker’s weighbridge certificate. If the tanker is not emptied completely, the residual mass must be determined by weighing (normal standard practice on larger projects where the tanker returns for refilling). Alternatively, dipstick measurements can be used to determine the amount actually used (following standard procedures for dipping tankers).

- Active filler

When using a spreader that draws powder from a silo on site, the application rate is checked using the standard “Canvas Patch” test. Theoretical consumption can be calculated and reconciled with the amount actually spread (data taken from the spreader’s computer). Once the silo has been emptied (and before being refilled), the total tonnage delivered to site can be reconciled.

When spreading by hand, the grid measurements for spreading each (standard sized) bag is physically checked and the number of bags opened and spread on each section of work is counted. The actual mass that was spread is then reconciled with the theoretical (calculated) amount.

D.1.5 Process Controls whilst the New Layer is being Processed

- The grader work is undertaken only after the primary compaction is complete.
- Sufficient water (or diluted emulsion when stabilising with bitumen emulsion) is sprayed on the exposed surfaces before any blading by grader is undertaken.
- There is a sufficient supply of water (or diluted emulsion) for processing (stand-by tanker).
- The grader's mould board is positioned at the correct depth and angle for each operation (windrowing and spreading).
- No untreated material or foreign matter is picked up when blading from a windrow placed outside the cut limits, (for example, on the shoulder).
- The smooth drum roller only starts compacting when the grader has finished placing the loose material.
- The edges of cut are exposed (every ± 5 m, both sides) and the roller is working within the cut limits.
- The speed of the roller in both directions (forwards and backwards) is consistent (< 3 km/hr).
- Sufficient passes are made on each section being compacted.
- Final levels are cut within tolerance and the surface "swept" with the surplus windrow.
- The PTR is operating at an appropriate speed and is following the required rolling pattern. The amount of slush being generated by the PTR is sufficient (and not too much).
- Surplus slush is broomed onto adjacent areas that are devoid of slush.

D.1.6 Process Controls after the New Layer has been Completed

- Any surplus slush generated by the PTR is removed from the surface of the layer (by sweeping or brooming).
- The windrow of surplus (bulked) material is picked up and removed from site.
- Where bitumen emulsion was applied, the finished layer remains closed to traffic (and remains closed until tests indicate that it may be opened).
- Where foamed bitumen was applied and the layer is to be opened to traffic:
 - The surface of the layer has dried to a moist state (and no rain is forecast for the forthcoming 12 hours).
 - The surface is treated with a fog spray within the specified time limits and at the required spray rate.
 - The layer is monitored for any degradation caused by trafficking and appropriate steps taken timeously to prevent further degradation.

D.1.7 Supervisor's Daily Report

As explained in Chapter 6, this report captures the important features of the day's production, including any relevant quality related features. It is, therefore, an important component of Process Control.

D.2 PROCESS CONTROL FOR IN PLANT MIXING PROJECTS

Although superior product quality is one of the primary benefits of mixing in plant, it can only be achieved if a comprehensive quality plan is established and strictly followed. The necessary checks, tests and measurements that need to be carried out to achieve such an objective fall under the heading of Process Control and are summarised below.

D.2.1 Preliminary Requirements before Mixing Starts

- Complete the pre-start checks (explained in Chapter 6).
- Check that the load cells have been tared (zeroed).
- Check that the computer has been reset and loaded with the required input data.
- Check the stockpile(s) of input material for any contamination, for example, overlapping stockpiles.
- Ensure that the necessary laboratory tests have been conducted on each input material and that the results are satisfactory. A minimum of 4 samples are to be taken from each stockpile of input material (following standard sampling procedures) and subjected to the following tests:
 - Grading (sieve analysis).
 - Moisture content.
 - Moisture / density relationship (SANS 3001-GR30).
 - Other specific tests as required, for example, durability.
- Where two materials are to be blended, check the gate openings at the base of each hopper. Where more than two materials are to be blended, check the set-up of the cold-feed bins
- Where the mixed material is to be placed in stockpile, check that sufficient space is available for the anticipated volume and that the floor is clean and competent

D.2.2 The Mixing Process

The following checks / tests / observations are carried out whilst the material is being mixed:

- The material for mixing is loaded by wheel loader into the correct hopper without spilling across into the adjacent hopper.
- The material flows consistently from each hopper onto the main conveyor (using the vibrators attached to the side of each hopper when necessary).
- The addition of bitumen emulsion or foamed bitumen, active filler and water is consistent (indicated on the console in the operator's cab).
- Visual appearance of the material on the delivery belt (consistency and the quality of the mix).
- The moisture content of the mix being discharged on to the delivery belt is appropriate (i.e. approximately 75% of OMC, determined by "feel").
- The hydraulic fluid pressure for the pugmill drive motors is not excessive.
- Samples of the mixed material for Acceptance Control tests are taken at the required locations (see Section D3.1) and carefully stored until being sent to the laboratory for testing. (Samples are taken from the bin of the truck immediately before the material is tipped into the paver's receiving hopper).

D.2.3 Handling the Mixed Product

There are two primary focus points that need to be controlled when handling the mixed material: segregation and moisture content:

- Material segregation

Where the material is loaded into trucks and hauled directly to site, care must be exercised to prevent the larger particles from congregating on the sides of the truck's bin. Material flying off the end of the delivery belt will tend to segregate in mid-air with the larger particles carrying further than the smaller ones. Positioning the truck in line with the belt so that loading commences at the front of the bin and the truck moves forward as the bin fills will usually limit the amount of segregation that occurs. Alternatively, a baffle placed at the end of the conveyor can limit the amount of segregation, provided such a baffle is correctly placed to prevent the larger particles from bouncing back too far.

Where the material is stockpiled beneath the belt, segregation is inevitable. Larger particles will fall on the side of the stockpile away from the conveyor and, as the stockpile grows in height, there will be a significant difference in the grading of the material on each side of the stockpile. This may be overcome by installing a

baffle at the end of the belt (as described above) or by judiciously moving the material with a front-end loader and placing it in a second stockpile.

Loading material from stockpile also needs to be controlled. Segregation is avoided by loading from a face, never from the side of the stockpile. The collapsing face will ensure that any segregation that occurred in building the stockpile is eliminated.

- **Moisture content**

The amount of water added to the material in the pugmill mixer is adjusted to achieve the moisture content required for mixing and compaction. Controls are required to prevent moisture loss due to evaporation while the material is transported to site, or from the surface of a stockpile. Such evaporation is normally avoided by covering the material with an impervious blanket, such as a tarpaulin, suitably anchored to prevent it from flapping in the wind. This is particularly important when the material is hauled over long distances in hot weather.

D.2.4 Stockpile Protection

Where material treated with foamed bitumen is stockpiled, additional controls are required to prevent the material from being compacted. Plant and trucks must not be allowed to run on the treated material. Stockpile height is, therefore, limited to the reach of a front-end loader or height of conveyor.

Care must also be taken to prevent moisture loss from the material in stockpile as well as protecting the surface of the stockpile from sunlight (UV bombardment). This is best achieved by sheeting the stockpile with a sturdy impervious tarpaulin. Where the material is to remain in stockpile for an extended period, it is advisable to thoroughly wet the material by spraying with water before sheeting.

D.2.5 Placing the New Layer

The important process controls include:

- Checking that the surface on which the new layer is to be constructed has been properly prepared by removing all loose material and spraying with sufficient water to prevent the material from being placed on a dry floor (that will suck the moisture from the new material, making it difficult to compact). Similarly, all construction joints have been thoroughly moistened before placing the abutting fresh material.
- When placing by paver:
 - Check the critical screed settings. Once the screed has been set up and an acceptable mat achieved, the settings must not be altered by an enthusiastic operator.
 - Care must be taken to prevent segregation. Material tipped into the paver's hopper at the start of work must remain in the wings until the end of work when it can be removed from site. This means that the wings must not be tilted to feed this material through to the screed.
 - As with all paving operations, paving should be continuous by limiting the advance speed to the delivery rate of material.
 - Trucks delivering material are to be engaged by the paver meeting the waiting truck (*not the* truck reversing into the paver).
- When placing by grader:
 - Sufficient water must be sprayed on the surface of the underlying layer before the material is imported.
 - To prevent the material from segregating as it flows off the end of the mould board, blading must be limited to placing and level cutting.
 - Whilst blading, water (or diluted bitumen emulsion) must be sprayed judiciously on the surface of the material to counter moisture loss due to evaporation.
- When using labour to construct a new thin layer:
 - The moisture content of the material in stockpile must first be checked to ensure that it approximates 75% of OMC. The moisture content is best estimated by feeling the material. If the material is too dry, no moisture will remain on the hand and the stockpile should then be treated with a generous spray of water (or diluted emulsion) and left to stand for a few minutes before loading. If too wet, free water will

remain on the hand and the stockpile should then be uncovered and allowed to dry (weather permitting) before loading.

- The material is loaded onto barrows or carts (normally by shovel) and transported to the road.
- All material from the tipped pile must then be pushed into place (including material at the base of the pile) so that the layer achieves a consistent loose density before compaction is applied.
- Pushing thin layers of fresh material on top of dry material must be avoided, especially if the underlying material has been partially or fully compacted.

D.2.6 Compacting the New Layer

To prevent the material from drying out, ensure that the correct combination of rollers compact the material as soon as it has been placed. The operation of each roller, the rolling pattern and the sequence of rolling are all determined by constructing a Trial Section and these must be followed meticulously to achieve the required density without rolling the layer out of shape. Finishing is usually carried out with a PTR adding sufficient water through the wheel sprinklers to achieve a tightly knit surface.

D.3 ACCEPTANCE CONTROL FOR ALL RECYCLING PROJECTS

For both in situ recycling and material mixed in plant, the end product is the completed layer. Requirements for acceptance include, as a minimum:

- The quality of the material in the layer. This is normally stated as a strength target, for example, $ITS_{WET} > 125$ kPa.
- The density of the material in the layer. This is normally stated as a minimum in terms of the percentage of the maximum dry density, for example, $> 100\%$ of MDD.
- The thickness of the layer. Thickness is normally specified with an allowable tolerance, for example, 250 mm \pm 10 mm.
- Surface shape and texture. The standard requirements for the relevant layer are normally specified for both rideability and surface texture, for example, for a new base layer, Standard COTO Specifications apply.

D.3.1 Determining the Tests Required and Location of Each Test

The table below summarises the minimum sampling / testing requirements that are typical for a day's production where the total area recycled / constructed is < 5000 m².

Activity / Parameter	Number	
Bulk sampling / specimen manufacture	6	<p>± 100 kg of sample obtained at predetermined locations from the full layer thickness. Samples are transported to the laboratory within the specified time limits. Sample preparation / manufacture specimens to determine:</p> <ul style="list-style-type: none"> • moisture/density relationship (SANS 3001-GR30) for all 6 samples (MDD/OMC) • the indirect tensile strength (3 of the 6 samples)
Field density measurements	6	<p>The field density is measured (nuclear gauge or sand replacement) at each of the predetermined locations.</p> <p>The moisture content of the material is determined by oven drying a sample obtained from the full layer thickness.</p> <p>The dry field density can then be calculated and compared with the relevant MDD to determine the % achieved</p>
Strength of material	3	Indirect tensile strength (ITS_{DRY} and ITS_{WET}) determined from specimens manufactured from 3 of the 6 samples (see Addendum D2)
Layer thickness	6	Layer thickness is physically measured at all predetermined locations by measuring the face of the holes dug to obtain samples for moisture determination.

The normal random stratified method is used to determine the location for where each test is to be taken.

It must be appreciated that recycled material is variable because it is the product of whatever the machine encounters in the existing pavement. The asphalt (or surfacing) component is often the primary contributor to variability due to changes in the thickness of the layer encountered as well as the competence of the layer (a severely cracked layer will produce a very different pulverised product than one that is intact). This means that any “average value” obtained from a series of test results should be treated with caution. Where an average is determined, the coefficient of variation (COV) should always be calculated and used to indicate the reliability that can be placed on such an average value. (A COV value < 15% is acceptable whereas a value > 25% needs to be investigated).

Field density measurements are often a contentious subject on recycling projects due to unreasonably high and/or low values being reported, for example, 106% or 94% of MDD. This is invariably a consequence of adopting an inappropriate MDD value to calculate the percentage, often an average determined from several test results spread over a large area. It is not unusual for the MDD of recycled material to vary by 5% (or more) over short distances, influenced by the type and grading of the material encountered in the recycling horizon. It is, therefore, standard practice on recycling projects to determine the moisture / density relationship of material sampled from each location where the density is measured.

It must also be borne in mind that only the upper horizon of an existing pavement is recycled, leaving the underlying structure undisturbed. The density that can be achieved when the recycled material is compacted is largely dictated by the support provided by this underlying structure; good support will permit a high level of density to be achieved whilst poor support will effectively limit the density achievable. It is, therefore, important to look beyond the test results when low densities are measured in the field.

Where the Process Controls established on site include Intelligent Compaction, the data thus acquired can be used to explain any unusual density result. Such data can be interrogated for details at any location on the layer that was compacted (normally for each 1 m²), to provide:

- The number of roller passes at that location.
- The travel speed of the roller for each pass.
- The amplitude and frequency of vibration applied for each pass.
- The resistance of the material in the layer (compactometer reading) for each pass.

Such information is invaluable for shedding light on a questionable density test result.

D.3.2 Sampling the Material in the New Layer

Addendum D1 includes standard methods for sampling the material that will be subjected to laboratory tests. Three sampling scenarios are included: sampling from the road behind the recycler, sampling from the bin of a truck and sampling from stockpile.

Note: Sampling from a conveyor belt (in plant mixing) is not included because such sampling requires the loaded belt to be stopped in order to collect all the material over a prescribed length of the belt. In addition to presenting a safety concern, stopping a continuous mixer is not advisable due to the interruption in the material flow caused by such a stoppage (the delivery conveyor on the plant cannot be stopped without closing down the entire system that feeds the belt).

D.3.3 Measuring the Density of the Material in the Completed Layer

When the layer thickness is in excess of 200 mm, normally the density of the full layer thickness is measured as well as the upper half of the layer.

A nuclear gauge is normally used to determine the bulk density of the completed layer. As part of the standard operating procedures when operating these gauges, the following requirements are important to ensure reliability of the measurements obtained:

- **Probe installation.** A hole must be created for lowering the probe to the required measurement depth. This is normally done by driving a rod into the layer with a sledge hammer. With coarser materials that are usually encountered when recycling base layers, drilling a hole with a suitable heavy-duty percussion drill has been shown to cause less damage to the layer and, consequently, allows greater confidence in the measurements obtain once the probe is installed.
- **Seating.** The gauge must be correctly placed on a bed of sand that is both level and continuous over the entire base area of the gauge.
- **Moisture determination.** The reading shown by the machine is meaningless due to the method used by the machine to estimate the amount of moisture in the layer (hydrogen atom count). Since all flexible surfacing material (asphalt, chip seals, as well as patching material and crack sealant) includes bitumen that is a hydro-carbon compound, incorporating these materials into the recycled mix increases the number of hydrogen atoms that the nuclear gauge will reflect as moisture. This is exacerbated when applying a bitumen stabilising agent. Consequently, the moisture content of the material in the layer must always be determined by oven drying a sample taken from the immediate vicinity of the density test.

Alternatively, the standard sand replacement test method can be followed to determine the density of the material, taking care when excavating the hole through coarse material to minimise disturbance caused to the material surrounding the hole.

D.3.4 Layer Thickness

Physical measurements of the layer thickness are made after excavating a hole through the layer, for example, at each test location where a hole is dug in order to obtain a sample for moisture determination.

Since such holes are excavated through the completed layer, they must be properly backfilled to avoid localised failures once the road is subjected to traffic loads. The following method is recommended for backfilling:

- Remove all loose material from the hole.
- Obtain material that is suitable for backfilling the hole (normally freshly mixed material is obtained from behind the recycler).
- This material is prepared by screening out material > 25 mm and thoroughly mixing with water to 1% above the OMC.
- Dampen the sides of the hole with water before placing and compacting the backfill in ± 50 mm thick layers with a hand tamper. The final layer must be at the same line and level as the surrounding surface with no mounding or sagging.

Nuclear density probe holes should be filled with a damp mixture of crusher dust < 5 mm and bitumen emulsion by slowly and continuously compacting with a tamping rod to avoid creating air pockets.

D.3.5 Strength Achieved

Addendum D2 describes the procedure to be followed to determine the strength from at least half of the samples taken in accordance with D3.1 above. (A minimum of three samples are to be tested for strength achieved).

D.3.6 Surface Finish

Several different methods can be used to specify the required surface finish, including profilometer readings, rolling straightedge, surface level tolerances, deviations from a 3 m straightedge, etc. The Standard COTO Specifications for new base layers should be adopted for rehabilitation projects.

However, where it can be shown that non-compliance is caused by factors beyond the control of the contractor, such as damage caused by early trafficking, these requirements may be relaxed.

D.4 OBTAINING CORE SPECIMENS FOR TESTING

Where the quality control measures described above indicate that there is a problem with either the strength of the material or the thickness of the new layer, a series of cores can be extracted from the layer and tested for compliance.

Core samples may be extracted from the full thickness of the completed layer, measured to determine the thickness of the layer and then tested for ITS values. Cores cannot be successfully extracted until the BSM has developed sufficient strength and the delay period is dictated by the rate of moisture loss from the material which is primarily a function of weather conditions and layer thickness. When conditions are warm and dry, cores can usually be extracted from a 150 mm thick layer of BSM-foam after 7 days. The delay period for BSM-emulsion is further influenced by the stability of the emulsion and delays in excess of 30 days are normal.

D.4.1 Extracting Core Samples

The core barrel used to extract samples of BSM must be in a good condition.

When the standard method of extracting 100 mm diameter cores from HMA is adopted, the amount of water added whilst drilling should be kept to an absolute minimum and the rate of penetration kept sufficiently low to prevent erosion and damage. After extraction, core samples must be wrapped individually in a soft cloth and carefully packed for transporting to the laboratory.

Preferably, 150mm diameter cores should be extracted using compressed air to cool the core barrel. The risk of damaging the core barrel is reduced by using a large enough compressor to supply a constant jet of air into the barrel whilst drilling at a slow rate of penetration. After extraction, core samples are wrapped individually in a plastic membrane (cling wrap) to prevent moisture loss and carefully packed for transporting to the laboratory. The advantage of using air is that the moisture content of the recovered sample is representative of in field conditions.

Where multiple cores are required to provide sufficient specimens for one test, they are to be extracted from the same area, normally within 50 mm of each other.

D.4.2 Cutting Core Specimens

A rotary saw fitted with a large diameter diamond-tipped blade is used to cut specimens from the portion of the core that suffered least damage during extraction and handling. The thickness (height) of individual specimens cut from the core is dictated by the diameter and the testing requirement:

- for ITS testing: 63 mm from 100 mm diameter core samples
95 mm from 150 mm diameter core samples
- for triaxial testing: 150 mm from 150 mm diameter cores (double-decked for testing)

Where possible, more than one specimen should be cut from each core sample.

D.4.3 Curing the Core Specimens

Specimens for ITS testing are cured to constant mass in a forced-draft oven at 40°C (normally 72 hours). Where the ITS_{WET} value is to be determined, the specimens are placed under water in a soaking bath for 24 hours.

Only 150 mm diameter specimens extracted using compressed air for cooling are suitable for triaxial testing (where the specimens are required to be at the equilibrium (or in situ) moisture content). To prevent moisture loss, specimens for triaxial testing are to be retained in their plastic wrapping until they are tested.

D.4.4 Testing the Core Specimens

The Test Methods described in Appendix B are to be followed:

- BSM4. Determination of the Indirect Tensile Strength
- BSM5. Determination of the shear properties (triaxial testing)

Notes:

- i. Only specimens cut from competent core samples should be cured and tested. After cutting, each specimen must be carefully inspected to ensure that it is free from defects (e.g. crumbling edges). Defective specimens must be discarded.
- ii. Where the ITS results for specimens manufactured from field samples are in conflict with those obtained from core specimens, the results for the core specimens should be taken as being the correct values.

ADDENDUM D1. SAMPLING FOR QUALITY CONTROL TESTS

Note: Sampling should always follow the methods described in the TMH5 publication. Included in this Addendum are the sampling requirements specific to BSMS.

Samples of the treated material are obtained from site and transported to the laboratory for testing. Test results are then used to make decisions, some of which can have a major financial impact. It is, therefore, of paramount importance to ensure that the samples collected in the field are truly representative.

This Addendum describes methods that should be followed to obtain such truly representative samples.

AD1.1 Sampling from Behind the Recycler

A sample of at least 100 kg is excavated from the full layer thickness behind the recycler before the material is compacted. Samples are to be retained in a sealed container, protected from direct sunlight and care taken to avoid compacting the material in the container. Samples are to be transported to the laboratory within 2 hours of sampling.

The hole created by extracting the sample is to be backfilled immediately with material shovelled in from the adjacent area (removing < 50 mm of material from any one location) and mixed with the surrounding material to achieve uniformity.

AD1.2 Sampling at the Mixing Plant

Samples should not be taken from the delivery conveyor whilst the belt is moving. Samples should be taken either from material in a loaded truck or from stockpile (see AD.1.4 below).

Sampling from the centre of the material in a loaded truck. Using shovels, dig a hole into the material as vertically as possible, ± 1 m in diameter and 1 m deep. Place a canvas sheet at the bottom of the hole and cut a slot of uniform depth into the side of the exposed face, allowing the material to fall on the canvas sheet. The slot should be widened over the full length to obtain the required quantity of material.

AD1.3 Sampling at the Paver

Sampling using a shovel to extract material from a paver's hopper should be discouraged because such samples are often not truly representative. It is preferable to sample from the truck before the material is tipped into the paver's hopper. Shovels are used to take samples from at least 100mm below the surface at a minimum of six (6) locations spread across the area of the truck.

AD1.4 Sampling Stockpiled Material

Note: Methods described in TMH5 for sampling material from stockpile are being revised. The methods described below remain relevant until the new TMH5MB1 is released with any changes.

Using a front-end loader, remove the material from at least (4) locations at the side of the stockpile so that each creates a vertical face. (The material thus removed should be transferred to locations where sampling is not undertaken). Starting from the bottom of the exposed face, push the loader's bucket approximately 300mm into the face and lift slowly so that the material falls into the bucket (approximately a quarter of the bucket is recovered from each sampling location). Deposit this material on a hard clean surface (or canvas sheet), mix thoroughly with the loader's bucket, or shovel, and then divide the material into four even quarters separate from each other. Remove two opposite quarters and mix the remaining two together. Repeat this process until a sample of the required amount is obtained.

If a front-end loader is not available, stockpiles can be sampled from the side of a stockpile using a pick and shovel to dig a slot (± 0.5 m in depth) from the top to the bottom of the stockpile. Remove all material that collects at the bottom of the slot from digging. Now place a canvas sheet of suitable size at the bottom of the slot and, using a pick and shovel, loosen a uniform thickness of material down the full length of the slot and, assisted by gravity, shovel it on to the canvas sheet. Mix the material thoroughly and quarter it as described above to obtain a sample of the required amount. Repeat this process at four locations around the perimeter of the stockpile.

The number of samples to be obtained will depend on the size of the stockpile. At least four (4) samples are to be taken from each separate stockpile where the amount of material in the stockpile is $< 4000 \text{ m}^3$. Where the stockpile is bigger than 4000 m^3 , one additional sample is taken for each additional 1000 m^3 .

ADDENDUM D2. MANUFACTURING SPECIMENS FOR QUALITY CONTROL

AD2.1 Sample Preparation

Prepare the sample by passing through a 20 mm sieve. Discard the fraction retained on the 20 mm sieve. Place the sample in an air-tight container and check that the container is retained at a temperature between 23°C and 25°C. If the temperature of the material is not within this temperature range, place the entire sample in an air cabinet (or similar) until the material is within this range.

AD2.2 Adjusting the Moisture Content and Manufacturing Test Specimens

Since the moisture content of field samples is normally in the range of 60% to 80% of OMC, sufficient water must be added to the sample to bring it to OMC before the test specimens are manufactured. Due to the variability of recycled material, it is seldom that the OMC will be known with certainty. The amount of water required to bring the sample to OMC must usually be determined (for each and every sample) using the procedure described in Section AD2.2.2 below.

AD2.2.1 Where the MDD and OMC of the material is known with certainty

- Determine the moisture content of the field sample;
- Adjust the moisture content of 20 kg of the sample to achieve OMC, mix thoroughly and place in an air-tight container; then
- Manufacture six 152 mm diameter specimens as described in Appendix B, Test Method BSM3.

AD2.2.2 Where the MDD and OMC of the material is not known, the moisture content of the sample must be adjusted to bring it to the OMC, as described below.

Step 1. Prepare the compaction equipment (mod AASHTO or vibrating hammer) by cleaning the mould, collar, base-plate and hammer face. (Note: the compaction equipment must not be heated but kept at ambient temperature).

Step 2. Weigh out three samples of material, each ± 1100 g (sufficient for a compacted layer ± 32 mm in height). Place the first sample in the mould and poke with a spatula 15 times around the perimeter and 10 times on the surface, leaving the surface slightly rounded. Ensure that the material does not lose moisture or segregate during placing in the mould and seal the remaining sample in the air-tight container.

Step 3. Compact the material by applying vibrating hammer or mod AASHTO compaction effort (25 seconds with the vibrating hammer or 55 blows with the mod AASHTO rammer). Roughen the surface of the compacted layer using an interlayer roughening device (as described in Appendix B for Test Method BSM3).

Step 4. Compact two additional layers using the same procedure described above (without roughening the surface of the third layer).

Step 5. After compacting the three layers, remove the mould from the base-plate, unscrew the bolts holding the split mould together and remove the specimen.

Step 6. Determine the mass of the specimen.

Step 7. Measure the height of the specimen at four evenly-spaced locations around the circumference and calculate the average height of the specimen.

Step 8. Measure the diameter of the specimen.

Step 9. Calculate the “interim” bulk density of the specimen using Equation 1 below:

$$BD_{INT} = \frac{4 \times M_{SPEC}}{\pi \times d^2 \times h} \times 1\,000\,000 \quad \text{[Equation 1]}$$

Where: BD_{INT} = interim bulk density [kg/m³]
 M_{SPEC} = mass of specimen [g]
 h = average height of specimen [mm]
 d = diameter of specimen [mm]

Then, using Equation 2 below, calculate the “true” bulk density by excluding the total amount of moisture that was added (if any):

$$BD = \left(\frac{BD_{INT}}{100 + \frac{W_{ADD}}{100}} \right) \times 100 \quad \text{[Equation 2]}$$

Where: BD = bulk density [kg/m³]
 BD_{INT} = interim bulk density (from Equation 1) [kg/m³]
 W_{ADD} = total moisture added to sample [%]

Step 10. Plot a graph of bulk density against water addition.

Note: The first point on the graph is zero water addition.

Step 11. Weigh out another 3300 g of material. Add 16.5 ml of water (0.5% by mass) and mix thoroughly before separating into three separate samples, each weighing approximately the same. Then follow the procedure described in Step 2 for preparing the first sample in the mould for compaction.

Step 12. Repeat Steps 3 to 10 and plot the result on the graph. Compare the bulk density with that achieved from the previous specimen. Continue to follow Steps 3 to 11 making specimens with additional water added until the bulk density reduces from the previous specimen.

Step 13. The amount of water added to the specimen that returns the highest bulk density (in percent) is then added to 20 kg of the remaining sample. Thoroughly mix the material and return to the air-tight container.

Note: If moisture is observed seeping out of the mould before a turning point in the curve is achieved, then the amount of water addition required to achieve the optimum moisture content is the amount of water added to the material at which seepage occurred, less 0.5%.

Step 14. Manufacture six 152 mm diameter specimens as described in Appendix B, Test Method BSM3.

AD2.3 Determining the Strength of the Specimens

Follow the procedure described in Appendix B, Test Method BSM4 to cure the specimens, identify outliers and determine the respective ITS_{DRY} and ITS_{WET} values.