

# LOST IN THE STORM

Designed by Shelley Swanland  
[www.shelleysstudio.com](http://www.shelleysstudio.com)

Featuring

*Floriculture* by Lynn

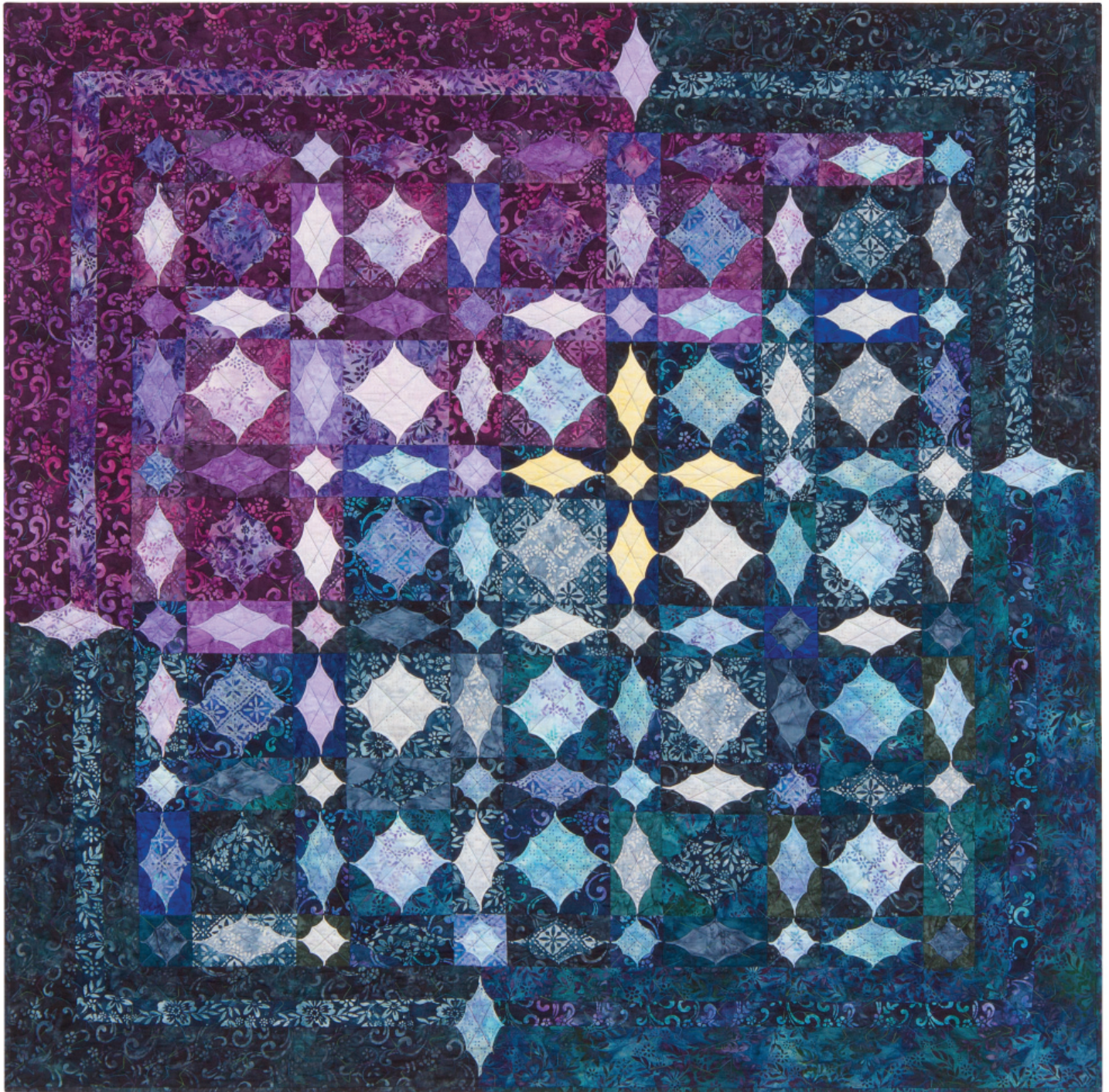

Finished quilt measures: 60" x 60"













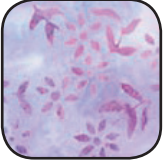

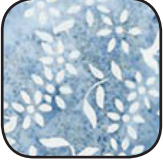

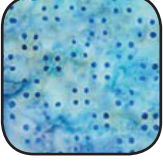
**Pattern Level: Advanced Expert**

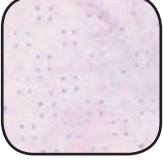
*"My skills are sharp, so I'm ready to take on the hard stuff."*

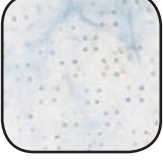
**ROBERT KAUFMAN**  
F A B R I C S

## Fabric and Supplies Needed

*Fabric amounts based on yardage that is 42" wide.*

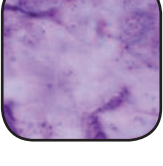
Color	Fabric	Name/SKU	Yardage	Color	Fabric	Name/SKU	Yardage
	A	AMD-15516-247 CORNFLOWER	1/2 yard		J	AMD-15519-247 CORNFLOWER	1/2 yard
	B	AMD-11516-250 LUPINE	3/4 yard		K	AMD-15519-250 LUPINE	1/2 yard
	C	AMD-11516-300 STORM	1-3/8 yard		L	AMD-15519-300 STORM	1/2 yard
	D	AMD-15517-247 CORNFLOWER	1 yard		M	AMD-15520-247 CORNFLOWER	1/2 yard
	E	AMD-15517-250 LUPINE	5/8 yard		N	AMD-15520-250 LUPINE	1/4 yard
	F	AMD-15517-300 STORM	3/4 yard		O	AMD-15520-300 STORM	3/8 yard
	G	AMD-15518-247 CORNFLOWER	3/8 yard		P	AMD-7000-9 NAVY	1/8 yard
	H	AMD-15518-250 LUPINE	3/8 yard		Q	AMD-7000-17 IRIS	1/8 yard
	I	AMD-15518-300 STORM	3/8 yard		R	AMD-7000-22 VIOLET	1/8 yard

## Fabric and Supplies Needed

*Fabric amounts based on yardage that is 42" wide.*

Color	Fabric	Name/SKU	Yardage	Color	Fabric	Name/SKU	Yardage
	S	AMD-7000-23 LAVENDER	3/8 yard		Y	AMD-7000-185 STEEL	1/4 yard
	T	AMD-7000-26 PETUNIA	3/8 yard		Z	AMD-7000-213 TEAL	1/8 yard
	U	AMD-7000-62 INDIGO	1/8 yard		AA	AMD-7000-221 AUBERGINE	1/8 yard
	V	AMD-7000-67 DENIM	3/8 yard		BB	AMD-7000-248 MARINE	1/8 yard
	W	AMD-7000-72 COBALT	1/8 yard		CC	AMD-7000-300 STORM	1/8 yard
	X	AMD-7000-139 BANANA	1/4 yard				

Copyright 2015, Robert Kaufman  
For individual use only - Not for resale

You will also need:  
4 yards for backing  
Binding is comprised of three different prints in the materials list above

### Notes Before You Begin

- Read through all of the instructions before beginning.
- All of the seam allowances are 1/4" unless otherwise noted.
- Press seam allowances open unless otherwise noted.
- Width of fabric (WOF) is equal to at least 42" wide.
- Right sides together has been abbreviated to RST.
- Remember to measure twice and cut once!

## Preparing for Cutting

Label each fabric A-CC. Careful placement of specific fabric colors is essential to the overall look of the quilt and labeled and organized fabrics aid in this process.

The Template pieces should be cut on grain per markings on the Template. The template should be marked on fabric. Gel pens work well. The outside lines can be cut with Rotary cutter. Inside angles should be cut with scissors.

Cut 6-1/2" Squares and Template Pieces from 6-1/2" strip.

The 2" squares can be cut from 2" strip.

The 3-1/2" squares can be cut from a 3-1/2" strip.

The rectangles can be cut from either a 2" or a 3-1/2" strip

## Cutting

### **Fabric A:**

- (4) 3-1/2" x WOF strips. Subcut:
  - sixteen 3-1/2" squares
  - twenty 2" x 3-1/2" rectangles
  - twenty-eight 2" squares
- (2) 2" x 40" border strips

### **Fabric B:**

- (1) 3-1/2" x WOF strip. Subcut:
  - twelve 3-1/2" squares
- (2) 2" x WOF strip. Subcut:
  - twelve 2" squares
  - twelve 2" x 3-1/2" rectangles
- (2) 4-1/2" x 40" border strips
- (2) 2-1/2" x 40" border strips
- (2) 2-1/2" x WOF strips for binding

### **Fabric C:**

- (3) 2" x WOF strips. Subcut:
  - four 2" squares
  - twenty-eight 2" x 3-1/2" rectangles
- (7) 2-1/2" x WOF strips. Subcut:
  - four 2-1/2" x 30" border strips
  - three 2-1/2" strips for binding
- (2) 3-1/2" x WOF strips. Subcut:
  - twenty 3-1/2" squares
- (4) 4-1/2" x WOF strips. Subcut:
  - four 4-1/2" x 30" border strips

### **Fabric D:**

- (5) 2-1/2" x WOF strips. Subcut:
  - three 2-1/2" strips for binding
  - two 2-1/2" x 40" border strips
  - four 2" squares (cut from border scraps)
- (3) 3-1/2" x WOF strips. Subcut:
  - sixteen 3-1/2" squares

twenty 2" x 3-1/2" rectangles  
(2) 4-1/2" x WOF strips. Subcut:  
two 4-1/2" x 40" border strips

**Fabric E:**

(2) 3-1/2" x WOF strips. Subcut:  
six 3-1/2" squares  
sixteen 2" x 3-1/2" rectangles  
(1) 6-1/2" x WOF strip. Subcut:  
three 6-1/2" squares  
two Template Pieces  
twelve 2" squares  
(2) 2" x WOF strips. Subcut:  
two 2" x 40" border strips

**Fabric F:**

(2) 3-1/2" x WOF strips. Subcut:  
sixteen 2" x 3-1/2" rectangles  
twelve 3-1/2" squares  
(5) 2" x WOF strips. Subcut:  
twelve 2" squares  
four 2" x 40" border strips  
From remaining fabric, cut:  
two 6-1/2" squares  
two Template Pieces

**Fabric G:**

three 6-1/2" squares  
three Template Pieces  
four 2" squares  
two 3-1/2" squares

**Fabric H:**

(1) 2" x WOF strip. Subcut:  
eight 2" squares  
(3) 3-1/2" x WOF strips. Subcut:  
sixteen 3-1/2" squares  
twenty-four 2" x 3-1/2" rectangles

**Fabric I:**

(1) 3-1/2" x WOF strip. Subcut:  
four 3-1/2" squares  
eight 2" x 3-1/2" rectangles  
From remaining fabric, cut:  
one 6-1/2" square  
four 2" squares  
three Template Pieces

**Fabric J:**

five 6-1/2" squares

seven Template Pieces (set one side for the right border)  
four 3-1/2" squares

**Fabric K:**

five 6-1/2" squares  
seven Template Pieces (set one side for the right border)  
four 3-1/2" squares

**Fabric L:**

three 6-1/2" squares  
five Template Pieces (set one side for the right border)  
two 3-1/2" squares

**Fabric M:**

three 6-1/2" squares  
seven Template Pieces (set one side for the bottom border)  
six 3-1/2" squares

**Fabric N:**

one 6-1/2" squares  
four Template Pieces  
one 3-1/2" squares

**Fabric O:**

two 6-1/2" squares  
six Template Pieces  
three 3-1/2" squares

**Fabric P:**

eight 2" squares  
four 2" x 3-1/2" rectangles

**Fabric Q:**

eight 2" squares  
eight 2" x 3-1/2" rectangles

**Fabric R:**

one Template Piece  
three 3-1/2" squares  
four 2" x 3-1/2" rectangles

**Fabric S:**

five Template Pieces (set one side for the top border)  
three 3-1/2" squares

**Fabric T:**

four Template Pieces  
one 3-1/2" square  
twelve 2" x 3-1/2" rectangles

**Fabric U:**

twelve 2" x 3-1/2" rectangles

**Fabric V:**

four Template Pieces  
four 3-1/2" squares  
four 2" x 3-1/2" rectangles

**Fabric W:**

four 2" squares  
twelve 2" x 3-1/2" rectangles

**Fabric X:**

four Template Pieces  
one 3-1/2" square

**Fabric Y:**

sixteen 2" squares  
eight 2" x 3-1/2" rectangles

**Fabric Z:**

eight 2" x 3-1/2" rectangles

**Fabric AA:**

eight 2" squares  
eight 2" x 3-1/2" rectangles

**Fabric BB:**

twelve 2" squares  
eight 2" x 3-1/2" rectangles

**Fabric CC:**

eight 2" x 3-1/2" rectangles

## Constructing the Blocks

Following the fabric placement chart for each block prepare the sets for construction. There are three different blocks used for this quilt.

*Tip: Stack fabrics for each block first, then begin sewing in groups. This helps to organize the many different fabrics in the quilt.*



### Fabric Placement Chart

Fabric designations shown in white and black letters.

**Block A** Each Block A uses one Square 6-1/2" for the three dimensional component and four squares for the background, 3-1/2" each.

Fold the 6-1/2" square in half, wrong sides together and the right side out, forming a rectangle. With the short end up and the raw edges to the left, place the rectangle between two background squares, right sides together. Line up the upper edge and the left side raw edges corners.



The background squares should extend 1/4" beyond the fold on the right hand side. Pin a generous 1/4" to 3/8" on the lep through all 4 layers. Pin the four layers on the right outside the stitching line.

With the fold towards you, backstitch to the pin, leaving 1/4" to 3/8" open, then finish the seam, stitching to the edge.

Turn the unit around with the un-sewn short end of the folded square up and the raw edges to the left.

The previously sewn background squares should fall out of the way. Place the folded square between two additional background squares. Line up, pin and sew as in the previous seam.

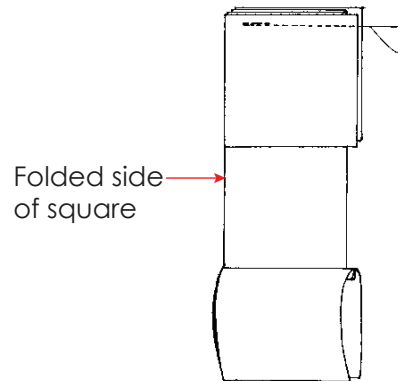

Open out the folded square bringing the two seam allowances together. Line up the two background squares to the right of the seams with the folded square between them.

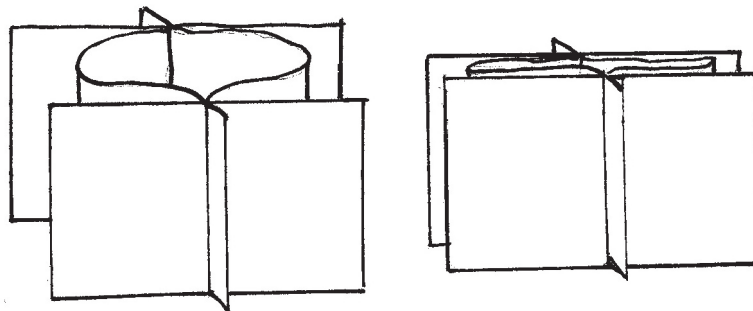

Pin and sew as with the two previous seams, starting at the stitching line from the previous step and sewing to the edge. Do not sew across the seam allowance that is between the two background squares. Instead, keep the seam allowance up and out of the way while you sew.

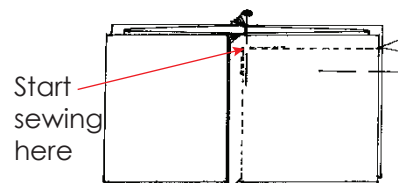

Turn the unit around and line up, pin and sew the final seam.

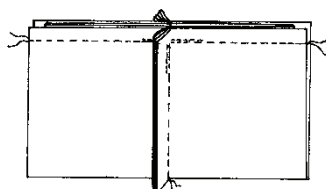

Flatten out the unit, pulling the unit into a 3-D on-point square with bias folded edges. Press the seams from the back in a counter clockwise direction. When pressing, put tension on the seams both crosswise and lengthwise so that you pull the block out as flat as possible. \*\*It is important that all the seams are pressed counter clockwise so that they will nest during the construction of the top.\*\*

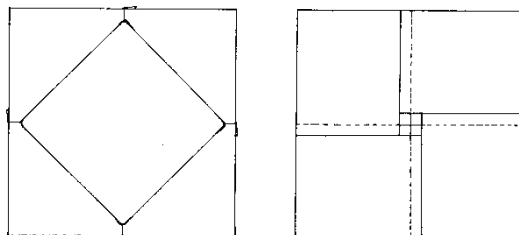

### Block B

Each Block B uses one Square 3-1/2" for the three dimensional component and four squares for the background, 2" each.

They are constructed just like Block B and it is still very important that the seams be pressed counterclockwise.

### Block C

Each Block C uses one Template piece for the three dimensional component and four rectangles for the background, 2" x 3-1/2" each.

1. Fold the Template piece in half with the wrong sides together and the right side out, lining up two of the long edges.

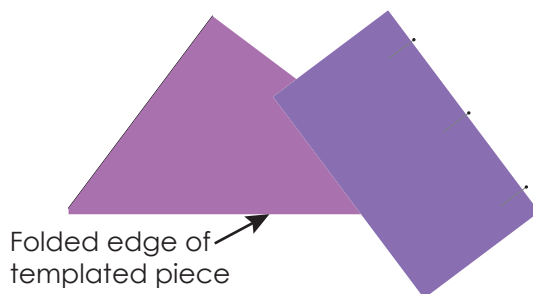

Sandwich the folded piece between two rectangles, right sides in, lining up the long edges. Pin a generous 1/4" to 3/8" on the left through all four layers. Pin the four layers on the right outside the stitching line.

2. With the fold towards you, back stitch to the pin, leaving 1/4" to 3/8" open, then finish the seam, stitching to the edge.

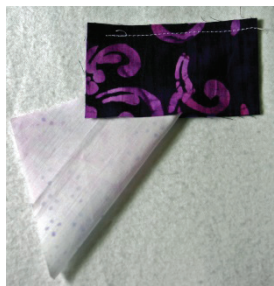

Repeat for the opposite side.



3. Open out the inside and bring the seams together. You will now be working with the shorter sides of the Template piece and they will line up with the shorter ends of the rectangles.



4. Carefully line up and pin the four layers and stitch just like all previous seams.



5. Press the seams counterclockwise from the back putting tension on the seams to pull them out flat.



There should be four Template Pieces left over for use in the borders.

## Construct the Top

Lay out the blocks following the fabric placement charts and the Quilt Assembly Diagram and sew them together in eleven rows of eleven blocks each.

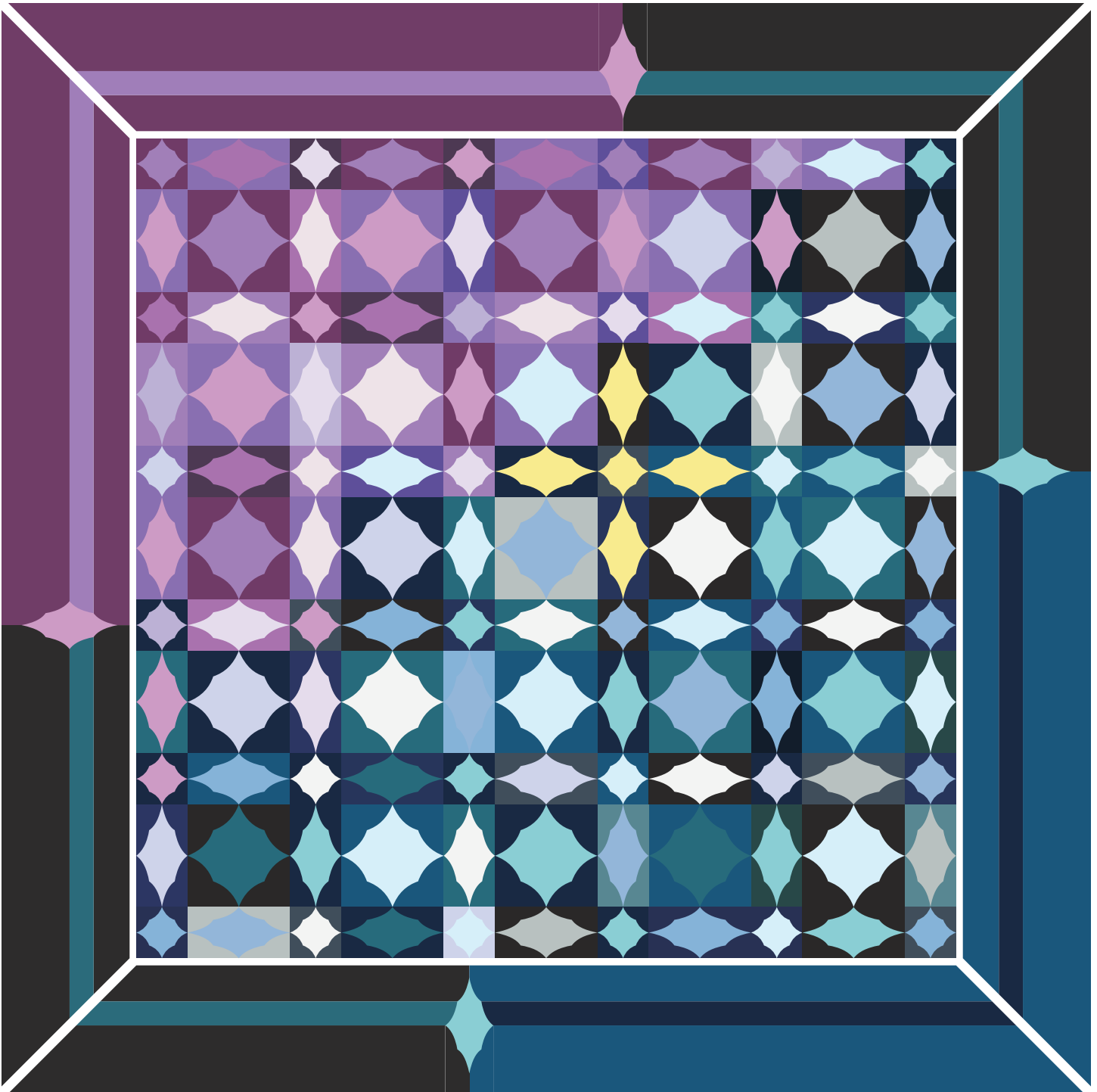

*Quilt Assembly Diagram*

**Borders**

The border strips have all been cut with an extra 4" because they will be mitered at the very end. Sew the 2" strips to the 2-1/2" strips but do not sew the 4-1/2" strips yet.



There will be two sets of three fabrics for each border. There will be a 3D Triangle sewn into the border at the point that these seams come together. The ends of the border strips at this

seam should be trimmed square. Treat these ends as you would the rectangles in sewing the C Blocks, sewing to the long edges of the 4-1/2" border strips in the corresponding spot on the template, just as you did in Block C, Steps 1 and 2 . Repeat on the remaining half with the strip set of the 2" and 2-1/2" strips. Then sew the sides and the seams of the border strips at the same time as you complete Steps 3 and 4 of the Block C instructions.

Pin the borders to the quilt top, aligning the 3D Triangle to the corresponding block shown in the finished sample.

### **Miter the Corners**

Pin the borders to the quilt top, aligning the 3D Triangle to the corresponding block shown in the finished sample. Sew the border, starting and stopping 1/4" from each end of the quilt top. Repeat for three other sides.

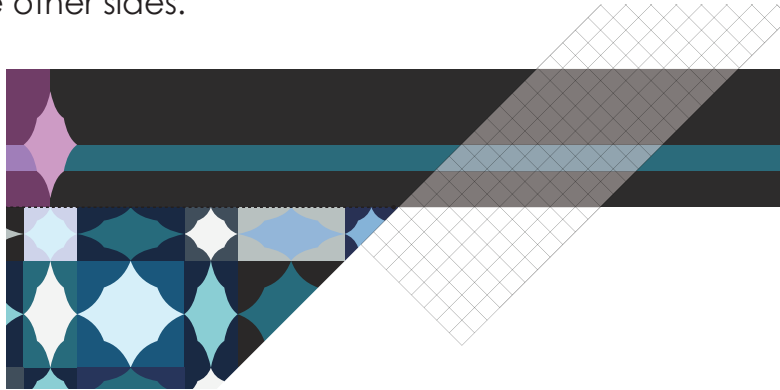

Fold the quilt in half diagonally, right sides together and align two of the borders directly on top of each other. Use your ruler to draw a line from the corner of the quilt to the edge of the border.

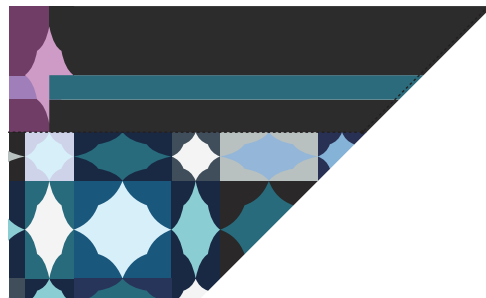

Trim off excess border along line and sew 1/4" in from the edge. Begin at the point where your border stitching had ended and sew to the edge of the border.

## Quilting

Once layered and pin basted, stitch a grid through the center of the squares lining up on the corners of each block creating an X and crossing through each fold.

## Detail Quilting

The bias folds created by the three dimensional elements of the blocks will now be rolled and stitched in place with a straight stitch, an open toe foot and a regular stitch length. Use cotton threads that match the blocks and the stitches will be barely visible when you are finished. Keep the feed dogs engaged. This is NOT free motion. Stitch each block individually. Roll and pin the fold on the opposite side as you approach. Pivot and continue down the pinned fold. Don't sew all the way to the point, because it will pop up later and take on a nice dimensional look.

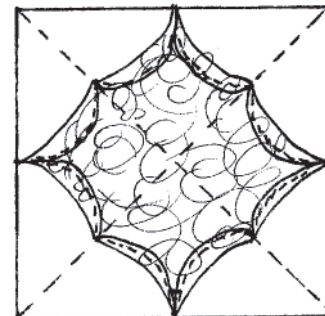

Quilt the border, trim and bind your quilt to complete!

## Template

Print template at 100%.

