



HP Photosmart 7520 Series

Contents

| | | |
|-----------|--|----------|
| 1 | HP Photosmart 7520 Series Help | 3 |
| 2 | Get to Know the HP Photosmart | |
| | Printer parts | 5 |
| | Control panel features | 6 |
| | Tips for getting to know the printer | 7 |
| 3 | How do I? | 9 |
| 4 | Print | |
| | Print photos from a memory card | 11 |
| | Select Print Media | 13 |
| | Load media | 13 |
| | Recommended papers for photo printing | 16 |
| | Recommended papers for printing and copying | 16 |
| | Tips for print success | 17 |
| 5 | Copy and scan | |
| | Scan to a computer, memory device, or email | 19 |
| | Copy text or mixed documents | 20 |
| | Tips for copy and scan success | 21 |
| 6 | Use Web Services | |
| | Print with HP ePrint | 23 |
| | Use HP Print Apps | 24 |
| | Visit the HP ePrintCenter website | 24 |
| | Tips for using Web Services | 24 |
| 7 | Fax | |
| | Send a fax | 25 |
| | Receive a fax | 29 |
| | Set up speed-dial entries | 32 |
| | Change fax settings | 33 |
| | Fax and digital phone services | 36 |
| | Fax over Internet Protocol | 37 |
| | Use reports | 37 |
| 8 | Work with cartridges | |
| | Check the estimated ink levels | 41 |
| | Clean cartridges automatically | 41 |
| | Align printer | 41 |
| | Replace the cartridges | 42 |
| | Order ink supplies | 44 |
| | Cartridge warranty information | 44 |
| | Tips for working with ink | 45 |
| 9 | Connectivity | |
| | Add the HP Photosmart to a network | 47 |
| | Change from a USB connection to a wireless network | 48 |
| | Connect a new printer | 49 |
| | Change network settings | 49 |
| | Wireless Direct | 49 |
| | Tips for setting up and using a networked printer | 50 |
| | Advanced printer management tools (for networked printers) | 50 |
| 10 | Solve a problem | |
| | Get more help | 53 |

| | |
|--|-----------|
| Register the product..... | 53 |
| Clear the paper jam..... | 53 |
| Clear carriage jam..... | 55 |
| Solve print problem..... | 55 |
| Solve copy and scan problem..... | 55 |
| Solve networking problem..... | 56 |
| HP support by phone..... | 56 |
| Additional warranty options..... | 57 |
| Cartridge supply upgrade..... | 57 |
| Prepare printer..... | 57 |
| Check cartridge access door..... | 57 |
| Printhead failure..... | 57 |
| Printer failure..... | 58 |
| Ink cartridge problem..... | 58 |
| SETUP cartridges..... | 59 |
| 11 Technical information | |
| Notice..... | 61 |
| Cartridge chip information..... | 61 |
| Specifications..... | 62 |
| Environmental product stewardship program..... | 63 |
| Regulatory notices..... | 69 |
| 12 Additional fax setup | |
| Set up faxing (parallel phone systems)..... | 77 |
| Serial-type fax setup..... | 96 |
| Test fax setup..... | 97 |
| Index..... | 99 |

1 HP Photosmart 7520 Series Help

Click the links below for information about the HP Photosmart:

- [Get to Know the HP Photosmart](#)
- [How do I?](#)
- [Print](#)
- [Copy and scan](#)
- [Work with cartridges](#)
- [Fax](#)
- [Load media](#)
- [Clear the paper jam](#)

2 Get to Know the HP Photosmart

- [Printer parts](#)
- [Control panel features](#)
- [Tips for getting to know the printer](#)

Printer parts

- **Front view of the printer**

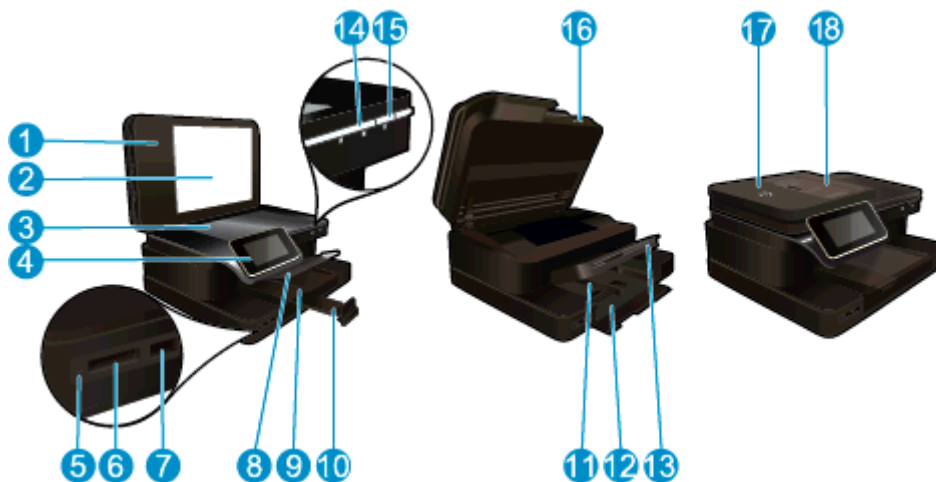

| | |
|----|---|
| 1 | Lid |
| 2 | Lid Backing |
| 3 | Glass |
| 4 | Color graphics display (also referred to as the display) |
| 5 | Memory Card slots LED |
| 6 | Memory Card slots |
| 7 | USB Drive slot |
| 8 | Photo tray |
| 9 | Paper-width guide for the photo tray |
| 10 | Paper tray extender (also referred to as the tray extender) |
| 11 | Paper-width guide for the main tray |
| 12 | Main tray (also referred to as the input tray) |
| 13 | Output tray |
| 14 | Wireless LED |
| 15 | On button |
| 16 | Cartridge door |
| 17 | Automatic document feeder |
| 18 | Automatic document feeder tray |

- **Top and rear views of the printer**

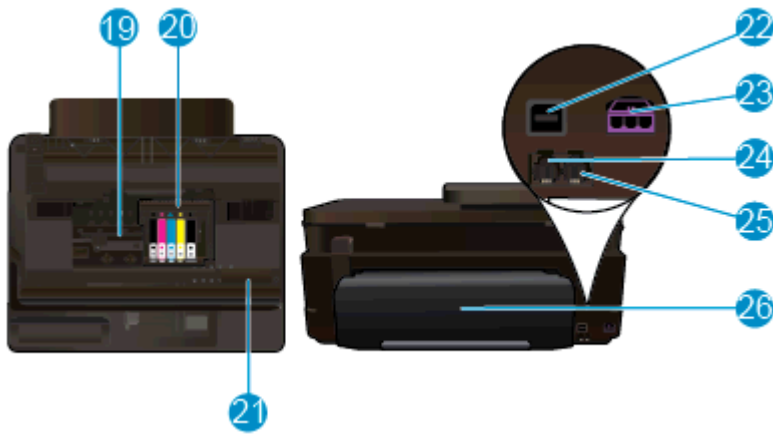

| | |
|----|--|
| 19 | Cartridge access area |
| 20 | Printhead assembly |
| 21 | Model number location |
| 22 | Rear USB port |
| 23 | Power connection (Use only with the power adapter supplied by HP). |
| 24 | Two-sided printing accessory |

Control panel features

The touch screen display shows menus, photos, and messages. You can touch and drag your finger horizontally to scroll through photos and vertically through menu options.

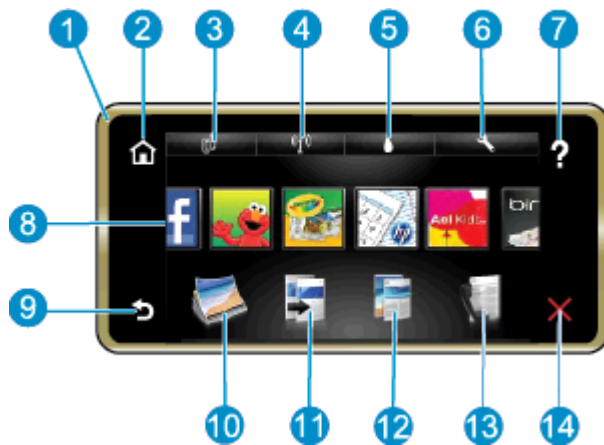

| | |
|----|--|
| 1 | Display: The touch screen display shows menus, photos, and messages. You can flick horizontally through photos and vertically through list menus. |
| 2 | Home: Returns to the Home screen (the default screen when you turn on the product). |
| 3 | Web Services: Opens the Web Services menu, which displays status details. You can also change settings and, if Web Services is enabled, print out a report.. |
| 4 | Wireless Settings: Opens the Wireless menu where you can see wireless properties and change wireless settings. |
| 5 | Ink Levels: Opens the Ink Levels menu showing estimated ink levels. |
| 6 | Settings: Opens the Settings menu where you can change product settings and perform maintenance functions. |
| 7 | Help: From the Help screen, lists the topics for which help is available. From other screens, provides help applicable to the current screen. |
| 8 | Apps: Provide quick and easy way to access and print information from the Apps, such as maps, coupons, coloring pages, and puzzles. |
| 9 | Back: Returns to the previous screen on the display. |
| 10 | Photo: Opens the Photo menu where you can view, edit, print, and save your photos. |
| 11 | Copy: Opens the Copy menu where you can preview your copy, edit for size and darkness, select black or color, and select the number of copies. You can also change settings to make 2-sided copies, or select size, quality, and paper type. |
| 12 | Scan: Opens the Choose Scan Destination menu, where you can select a destination for your scan. |
| 13 | Fax: Displays a screen where you can send a fax, or choose fax settings. |
| 14 | Cancel: Stops the current operation. |

Tips for getting to know the printer

Use the following tips to get to know the printer:

- Learn how to manage print apps for printing recipes, coupons, and other content from the web. [Click here to go online for more information.](#)

3 How do I?

This section contains links to commonly performed tasks, such as printing photos, scanning, and making copies.

- [Scan to a computer, memory device, or email](#)
- [Copy text or mixed documents](#)
- [Clear the paper jam](#)
- [Replace the cartridges](#)
- [Load media](#)
- [Use Web Services](#)

4 Print



[Print photos from a memory card](#)

Related topics

- [Load media](#)
- [Tips for print success](#)

Print photos from a memory card

Do one of the following:

Print photo on small-size paper

1. Load paper.
 - ▲ Load up to 10 x 15 cm (4 x 6 inch) photo paper print side down in photo tray.

Load photo paper in the photo tray



2. Insert a memory device.

Insert a memory device

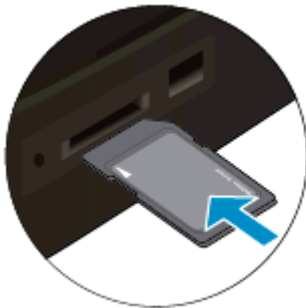

3. Select photo.
 - a. Touch **Photo** on the Home screen.
 - b. Touch **View & Print**.
 - c. Flick left or right to scroll through the photos.
 - d. Touch photo you want to print.
 - e. Touch up arrow to increase number of copies.
4. Print photo.
 - a. Touch **Print** to preview print job.
 - b. Touch **Print**.

Print photo on full-size paper

1. Load paper.
 - ▲ Load full-size photo paper print side down in the main input tray.

Load paper



2. Insert a memory device.

Insert a memory device

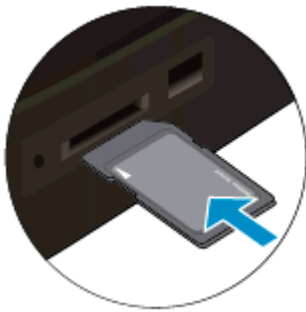

3. Select photo.
 - a. Touch **Photo** on the Home screen.
 - b. Touch **View & Print**.
 - c. Flick left or right to scroll through the photos.
 - d. Touch photo you want to print.
 - e. Touch up arrow to increase number of copies.
4. Change page layout.
 - a. Touch **Print** to preview print job.
 - b. Touch **Print Settings** to change print settings.
 - c. Touch **Layout**.
 - d. Touch **8.5x11**.
5. Print photo.
 - ▲ Touch **Print**.

Memory cards and slots

Your printer has one of the following configurations and supports the memory card types listed below.

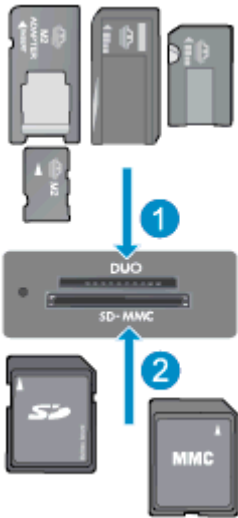

| | |
|---|--|
| 1 | Memory Stick Duo or Pro Duo, Memory Stick Pro-HG Duo, or Memory Stick Micro (adapter required) |
| 2 | MultiMedia Card (MMC), MMC Plus, Secure MultiMedia Card, MMC Mobile (RS-MMC; adapter required), Secure Digital (SD), Secure Digital Mini, Secure Digital High Capacity (SDHC), Secure Digital Extended Capacity (SDXC), or TransFlash MicroSD Card (adapter required), |

- Or -

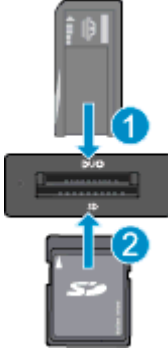

| | |
|---|--|
| 1 | Memory Stick Duo or Pro Duo, Memory Stick Pro-HG Duo, or Memory Stick Micro (adapter required) |
| 2 | Secure Digital (SD), Secure Digital Mini, Secure Digital High Capacity (SDHC), Secure Digital Extended Capacity (SDXC), or TransFlash MicroSD Card (adapter required), |

Select Print Media

The printer is designed to work well with most types of office media. Use HP media for optimum print quality. Visit the HP Web site at www.hp.com for more information about HP media.

HP recommends plain papers with the ColorLok logo for printing and copying of everyday documents. All papers with the ColorLok logo are independently tested to meet high standards of reliability and print quality, and produce documents with crisp, vivid color, bolder blacks and dry faster than ordinary plain papers. Look for papers with the ColorLok logo in a variety of weights and sizes from major paper manufacturers.

To purchase HP papers, go to [Shop for Products and Services](#) and select ink, toner and paper.

Load media

- ▲ Do one of the following:

Load 10 x 15 cm (4 x 6 inch) paper

- a. Raise photo tray lid.
 - Raise photo tray lid and slide paper-width guide outwards.
- b. Load paper.
 - Insert stack of photo paper into photo tray with short edge forward and print side down.

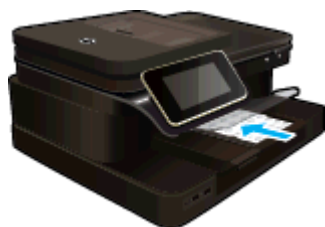

- Slide stack of paper forward until it stops.

 **NOTE:** If the photo paper you are using has perforated tabs, load photo paper so that tabs are closest to you.

- Slide paper-width guide inward until it stops at edge of paper.



- c. Lower photo tray lid.



Load A4 or 8.5 x 11 inch paper

- a. Raise the photo tray.

- Slide paper-width guide outwards.



- Remove all paper from the main input tray.
- b. Load paper.
 - Insert stack of paper into main input tray with short edge forward and print side down.

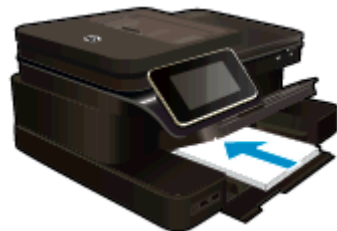

- Slide stack of paper forward until it stops.
- Slide paper-width guide inward until it stops at edge of paper.



- Lower the photo tray.

Load envelopes

- Raise the photo tray.
 - Slide paper-width guide outwards.



- Remove all paper from the main input tray.
- Load envelopes.
 - Insert one or more envelopes into far-right side of main input tray, with envelope flaps on left and facing up.

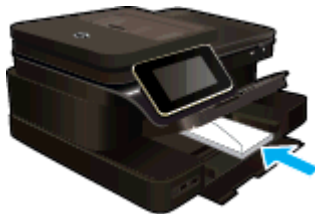

- Slide stack of envelopes forward until it stops.
- Slide paper-width guide inward against stack of envelopes until it stops.



- Lower the photo tray.

Related topics

- [Tips for print success](#)

Recommended papers for photo printing

If you want the best print quality, HP recommends using HP papers that are specifically designed for the type of project you are printing. Depending on your country/region, some of these papers might not be available.

| Paper | Description |
|------------------------------------|--|
| HP Premium Plus Photo Paper | HP's best photo paper is heavyweight for producing professional-quality photos. Features an instant-dry finish for easy handling without smudging. It resists water, smears, fingerprints, and humidity. It is available in several sizes, including A4, 8.5 x 11 inch, 10 x 15 cm (4 x 6 inch), 13 x 18 cm (5 x 7 inch) and two finishes – high gloss or soft gloss (satin matte). It is acid-free for longer lasting documents. |
| HP Advanced Photo Paper | This thick photo paper features an instant-dry finish for easy handling without smudging. It resists water, smears, fingerprints, and humidity. Your prints have a look and feel comparable to a store processed photo. It is available in several sizes, including A4, 8.5 x 11 inch, 10 x 15 cm (4 x 6 inch), 13 x 18 cm (5 x 7 inch) and two finishes – glossy or soft gloss (satin matte). It is acid-free for longer lasting documents. |
| HP Everyday Photo Paper | Print colorful, everyday snapshots at a low cost, using paper designed for casual photo printing. This affordable, photo paper dries quickly for easy handling. Get sharp, crisp images when you use this paper with any inkjet printer. Available in glossy finish in 8.5 x 11 inch, A4, 4 x 6 inch and 10 x 15 cm. It is acid-free for longer lasting documents. |
| HP Photo Value Packs | HP Photo Value Packs conveniently package Original HP ink cartridges and HP Advanced Photo Paper to save you time and take the guesswork out of printing affordable Lab-quality photos with your HP printer. Original HP inks and HP Advanced Photo Paper have been designed to work together so your photos are long lasting and vivid, print after print. Great for printing out an entire vacation's worth of photos or multiple prints to share. |

Recommended papers for printing and copying

Depending on your country/region, some of these papers might not be available.

| Paper | Description |
|--|---|
| HP Brochure Paper and HP Professional Paper 180gsm | These papers are glossy-coated or matte-coated on both sides for two-sided use. They are the best choice for producing professional-quality marketing materials such as brochures and mailers as well as business graphics for report covers and calendars. |
| HP Premium Presentation 120gsm Paper and HP Professional Paper 120gsm | These papers are heavy two-sided matte papers perfect for presentation, proposals, reports and newsletters. They are a professional weight for an impressive look and feel. |
| HP Bright White Inkjet Paper | HP Bright White Inkjet Paper delivers high-contrast colors and sharp text. It is opaque enough for two-sided color usage with no showthrough, which makes it ideal for newsletters, reports, and flyers. It features ColorLok Technology for less smearing, bolder blacks and vivid colors. |
| HP Printing Paper | HP Printing Paper is a high-quality multifunction paper. It produces documents that look and feel more substantial than documents printed on standard multipurpose or copy paper. It features ColorLok Technology for less smearing, bolder blacks and vivid colors. |

(continued)

| Paper | Description |
|--------------------------|--|
| HP Office Paper | HP Office Paper is a high-quality multifunction paper. It is suitable for copies, drafts, memos and other everyday documents. It features ColorLok Technology for less smearing, bolder blacks and vivid colors. |
| HP Office Recycled Paper | HP Office Recycled Paper is a high-quality multifunction paper made with 30% recycled fiber. It features ColorLok Technology for less smearing, bolder blacks and vivid colors. |
| HP Iron-On Transfers | HP Iron-on Transfers (for color fabrics or for light or white fabrics) are the ideal solution for creating custom T-shirts from your digital photos. |

Tips for print success

Use the following tips to print successfully.

Print tips

- Use genuine HP cartridges. Genuine HP cartridges are designed for and tested with HP printers to help you produce great results, time after time.
- Make sure the cartridges have sufficient ink. To check the estimated ink levels, touch the Ink Levels icon on the printer display.
- Load a stack of paper, not just one page. Use clean and flat paper of the same size. Make sure only one type of paper is loaded at a time.
- Adjust the paper-width guide in the input tray to fit snugly against all paper. Make sure the paper-width guide does not bend the paper in the input tray.
- Set the print quality and paper size settings according to the type and size of paper loaded in the input tray.
- If you want to print a black and white document using black ink only, do one of the following according to your operating system.
 - **On Windows:** Open your printer software, click **Set Preferences**. On the **Paper/Quality** tab, click **Advanced**. Select **Black Ink Only** from the **Print in Grayscale** drop-down list under **Printer Features**.
 - **On Mac:** From the Print dialog box, choose the **Paper Type/Quality** pane, click **Color Options**, and then choose **Grayscale** from the Color pop-up menu.
If the Print dialog does not show printer options, click the blue disclosure triangle next to the printer name (Mac OS X v10.6) or **Show Details** (Mac OS X v10.7). Use the pop-up menu toward the bottom of the dialog to choose the **Paper Type/Quality** pane.
- Use print preview to check margins. Do not let the margin settings for the document exceed the printable area of the printer.
- Learn how to share your photos online and order prints. [Click here to go online for more information.](#)
- Learn how to print documents from computer. [Click here to go online for more information.](#)
- Learn how to print photos saved on your computer. Learn about print resolution and how to set the maximum DPI. [Click here to go online for more information.](#)
- Learn how to print envelopes from computer. [Click here to go online for more information.](#)
- Learn more about managing apps for printing recipes, coupons, and other content on the HP ePrintCenter website. [Click here to go online for more information.](#)
- Learn how to print from anywhere by sending an email and attachments to your printer. [Click here to go online for more information.](#)

5 Copy and scan

- [Scan to a computer, memory device, or email](#)
- [Copy text or mixed documents](#)
- [Tips for copy and scan success](#)

Scan to a computer, memory device, or email

To scan to a computer, memory device, or email.

1. Load the original.
 - a. Lift the lid on the product.



- b. Load original print side down on the right front corner of glass.



- c. Close the lid.
2. Start scan.
 - a. On the Home screen, touch **Scan**.
 - b. Select the destination by touching either **Computer**, **USB Flash Drive**, **Memory Card** or **E-mail**.
If you are scanning to a computer and the printer is network-connected, a list of available computers appears. Select the computer on which you want the scan saved.
For scanning to a USB Drive, insert a USB Drive in the slot.
For scanning to a Memory Card, insert a Memory Card in the slot.
 - c. Touch **Scan**.

Related topics

- [Tips for copy and scan success](#)

Copy text or mixed documents

- ▲ Do one of the following:

1-sided copy

- a. Load paper.
 - Load full-size paper in the main input tray.



- b. Load original.
 - Load original print side up into the automatic document feeder.



- c. Specify number of copies.
 - Touch **Copy** on Home screen. The **Copy** preview appears.
 - Touch the screen to set the number of copies.
- d. Start copy.
 - Touch **B&W** or **Color**.

2-sided copy

- a. Load paper.
 - Load full-size paper in the main input tray.



- b. Load original.
 - Load original print side up into the automatic document feeder.



- c. Specify 2-sided option.
 - Touch **Copy** on Home screen.
The **Copy** preview appears.
 - Touch **Print Settings**.
The **Copy Settings** menu appears.
 - Touch **2-Sided**.
 - Touch **On**.
- d. Specify number of copies.
 - Use the touch screen to set the number of copies.
- e. Start copy.
 - Touch **B&W** or **Color**.
- f. Copy the second original.
 - Load second page into the automatic document feeder and touch **OK**.

Related topics

- [Tips for copy and scan success](#)
Learn more about using the automatic document feeder to scan your documents. [Click here to go online for more information.](#)

Tips for copy and scan success

Use the following tips to copy and scan successfully:

- Keep the glass and the back of the lid clean. The scanner may interpret anything it detects on the glass as part of the image.
- Load your original, print side down, on the right front corner of the glass or, print side up, into the automatic document feeder. Learn how to use the automatic document feeder for scanning and copying. [Click here to go online for more information.](#)
- To make a large copy of a small original, scan the original into the computer, resize the image in the scanning software, and then print a copy of the enlarged image.
- To avoid incorrect or missing scanned text, make sure the brightness is set appropriately in the software.
- If the document to be scanned has a complex layout, select framed text as the scan document setting in the software. With this setting, the text layout and formatting are retained.
- If the scanned image is incorrectly cropped, turn off the autocropping feature in the software and crop the scanned image manually.

6 Use Web Services

- [Print with HP ePrint](#)
- [Use HP Print Apps](#)
- [Visit the HP ePrintCenter website](#)
- [Tips for using Web Services](#)

Print with HP ePrint

HP's free ePrint service provides an easy way to print from email. Just email a document or photo to the email address assigned to your printer when you enable Web Services, and both the email message and recognized attachments will print.

- Your printer needs to have a wireless network connection to the Internet. You won't be able to use ePrint via a USB connection to a computer.
- Attachments might print differently from the way they appear in the software program that created them, depending on the original fonts and layout options used.
- Free product updates are provided with ePrint. Some updates might be required to enable certain functionality.

Related topics

- [Your printer is protected](#)
[How to get started with ePrint](#)

Your printer is protected

To help prevent unauthorized email, HP assigns a random email address to your printer, never publicizes this address, and by default does not respond to any sender. ePrint also provides industry-standard spam filtering and transforms email and attachments to a print-only format to reduce the threat of virus or other harmful content. However, the ePrint service does not filter email based on content, so it cannot prevent objectionable or copyrighted material from being printed.

Go to the HP ePrintCenter website for more information and specific terms and conditions: www.hp.com/go/ePrintCenter.

How to get started with ePrint

To use ePrint, connect your printer to an active wireless network with Internet access, set up an account on HP ePrintCenter, and add your printer to the account.

To get started with ePrint

1. Enable Web services.
 - a. Touch the **ePrint** button on the control panel.
 - b. Accept the terms of use, and then follow the onscreen instructions to enable Web Services. The ePrint information sheet prints, containing a printer code.
 - c. Go to www.hp.com/go/ePrintCenter, click the **Sign In** button, and then click the **Sign Up** link at the top of the window that appears.
 - d. When prompted, enter the printer code to add your printer.
2. Touch **ePrint** on the control panel. From the **Web Services Summary** screen, get your printer's email address.
3. Compose and send email to your printer's email address from your computer or mobile device, anywhere and anytime. Both the email message and recognized attachments will print.

Use HP Print Apps

Print pages from the web, without using a computer, by setting up **Print Apps**, a free service from HP. You can print coloring pages, calendars, puzzles, recipes, maps, and more, depending on the apps available in your country/region.

Touch the **Get More** icon on the **Print Apps** screen to connect to the Internet and add more apps. You need to have Web Services enabled in order to use apps.

Go to the HP ePrintCenter website for more information and specific terms and conditions: www.hp.com/go/ePrintCenter.

Visit the HP ePrintCenter website

Use HP's free ePrintCenter website to set up increased security for ePrint and specify the email addresses that are allowed to send email to your printer. You can also get Product Updates, more Print Apps, and other free services.

Go to the HP ePrintCenter website for more information and specific terms and conditions: www.hp.com/go/ePrintCenter.

Tips for using Web Services

Use the following tips to print apps and use ePrint.

Tips for printing apps and using ePrint

- Learn how to share your photos online and order prints. [Click here to go online for more information.](#)
- Learn about apps for printing recipes, coupons, and other content from the web, simply and easily. [Click here to go online for more information.](#)
- Learn how to print from anywhere by sending an email and attachments to your printer. [Click here to go online for more information.](#)
- If you have enabled **Auto Power-Off**, you should disable **Auto Power-Off** to use ePrint. See [Auto Power-Off](#) for more information.

7 Fax

You can use the printer to send and receive faxes, including color faxes. You can schedule faxes to be sent at a later time and set up speed-dials to send faxes quickly and easily to frequently used numbers. From the printer control panel, you can also set a number of fax options, such as resolution and the contrast between lightness and darkness on the faxes you send.

 **NOTE:** Before you begin faxing, make sure you have set up the printer correctly for faxing. You might have already done this as part of the initial setup, by using either the control panel or the HP software provided with the printer. You can verify the fax is set up correctly by running the fax setup test from the control panel. For more information on the fax test, see [Test fax setup](#).

This section contains the following topics:

- [Send a fax](#)
- [Receive a fax](#)
- [Set up speed-dial entries](#)
- [Change fax settings](#)
- [Fax and digital phone services](#)
- [Fax over Internet Protocol](#)
- [Use reports](#)

Send a fax

You can send a fax in a variety of ways. Using the printer control panel, you can send a black-and-white or color fax. You can also send a fax manually from an attached phone. This allows you to speak with the recipient before sending the fax.

This section contains the following topics:

- [Send a standard fax](#)
- [Send a standard fax from the computer](#)
- [Send a fax manually from a phone](#)
- [Send a fax using monitor dialing](#)
- [Send a fax from memory](#)
- [Schedule a fax to send later](#)
- [Send a fax in Error Correction Mode](#)

Send a standard fax

You can easily send a single- or multiple-page black-and-white or color fax by using the printer control panel.

 **NOTE:** If you need printed confirmation that your faxes were successfully sent, fax confirmation must be enabled.

 **TIP:** You can also send a fax manually from a phone or by using monitor dialing. These features allow you to control the pace of your dialing. They are also useful when you want to use a calling card to charge the call and you have to respond to tone prompts while dialing.

To send a standard fax from the printer control panel

1. Load your original print-side down in the right-front corner of the glass or print-side up in the Automatic Document Feeder.
2. Touch **Fax**.

3. Enter the fax number by using the keypad.

 **TIP:** To add a pause in the fax number you are entering, touch * repeatedly, until a dash (-) appears on the display.

4. Touch **Black** or **Color**.

If an original is loaded in the automatic document feeder, the document is sent to the number you entered. If no original is detected in the automatic document feeder, a message appears that prompts you to make a selection.

 **TIP:** If the recipient reports issues with the quality of the fax you sent, you can try changing the resolution or contrast of your fax.

Send a standard fax from the computer

You can send a document on your computer as a fax, without printing a copy and faxing it from the printer.

 **NOTE:** Faxes sent from your computer by this method use the printer's fax connection, not your Internet connection or computer modem. Therefore, make sure the printer is connected to a working telephone line and that the fax function is set up and functioning correctly.

To use this feature, you must install the printer software using the installation program provided on the HP software CD provided with the printer.

Windows

1. Open the document on your computer that you want to fax.
2. On the **File** menu in your software application, click **Print**.
3. From the **Name** list, select the printer that has “**fax**” in the name.
4. To change settings (such as selecting to send the document as a black fax or a color fax), click the button that opens the **Properties** dialog box. Depending on your software application, this button might be called **Properties**, **Options**, **Printer Setup**, **Printer**, or **Preferences**.
5. After you have changed any settings, click **OK**.
6. Click **Print** or **OK**.
7. Enter the fax number and other information for the recipient, change any further settings for the fax, and then click **Send Fax**. The printer begins dialing the fax number and faxing the document.

Mac OS X

1. Open the document on your computer that you want to fax.
2. From the **File** menu in your software application, click **Print**.
3. Select the printer that has “**(Fax)**” in the name.
4. Select **Fax Recipients** from the pop-up menu below the **Orientation** setting.

 **NOTE:** If you cannot find the pop-up menu, try clicking the disclosure triangle next to the **Printer selection**.

5. Enter the fax number and other information in the boxes provided, and then click **Add to Recipients**.
6. Select the **Fax Mode** and any other fax options you want, and then click **Send Fax Now** to begin dialing the fax number and faxing the document.

Send a fax manually from a phone

Sending a fax manually allows you to make a phone call and talk with the recipient before you send the fax. This is useful if you want to inform the recipient that you are going to send them a fax before sending it. When you send a fax manually, you can hear the dial tones, telephone prompts, or other sounds through the handset on your telephone. This makes it easy for you to use a calling card to send your fax.

Depending on how the recipient has their fax machine set up, the recipient might answer the phone, or the fax machine might take the call. If a person answers the phone, you can speak with the recipient before sending the

fax. If a fax machine answers the call, you can send the fax directly to the fax machine when you hear the fax tones from the receiving fax machine.

To send a fax manually from an extension phone

1. Load your original print-side down in the right-front corner of the glass or print-side up in the Automatic Document Feeder.
2. Touch **Fax**.
3. Dial the number by using the keypad on the phone that is connected to the printer.

 **NOTE:** Do not use the keypad on the control panel of the printer when manually sending a fax. You must use the keypad on your phone to dial the recipient's number.

4. If the recipient answers the telephone, you can engage in a conversation before sending your fax.

 **NOTE:** If a fax machine answers the call, you will hear fax tones from the receiving fax machine. Proceed to the next step to transmit the fax.

5. When you are ready to send the fax, touch **Send Fax Manually**.

 **NOTE:** If prompted, select **Fax Black** or **Fax Color**.

If you were speaking with the recipient before sending the fax, inform the recipient that they should press **Start** on their fax machine after they hear fax tones.

The telephone line is silent while the fax is transmitting. At this point, you can hang up the telephone. If you want to continue speaking with the recipient, remain on the line until the fax transmission is complete.

Send a fax using monitor dialing

Monitor dialing allows you to dial a number from the printer control panel as you would dial a regular telephone. When you send a fax using monitor dialing, you can hear the dial tones, telephone prompts, or other sounds through the speakers on the printer. This enables you to respond to prompts while dialing, as well as control the pace of your dialing.

 **TIP:** If you are using a calling card and do not enter your PIN fast enough, the printer might start sending fax tones too soon and cause your PIN not to be recognized by the calling card service. If this is the case, you can create a speed dial entry to store the PIN for your calling card. For more information, see [Set up speed-dial entries](#).

 **NOTE:** Make sure the volume is turned on to hear a dial tone.

To send a fax using monitor dialing from the printer control panel

1. Load your original print-side down in the right-front corner of the glass or print-side up in the Automatic Document Feeder.
2. Touch **Fax**, and then touch **Black** or **Color**.
If the printer detects an original loaded in the automatic document feeder, you hear a dial tone.
3. When you hear the dial tone, enter the number by using the keypad on the printer control panel.
4. Follow any prompts that might occur.

 **TIP:** If you are using a calling card to send a fax and you have your calling card PIN stored as a speed

dial, when prompted to enter your PIN, touch  (Speed Dial) to select the speed dial entry where you have your PIN stored.

Your fax is sent when the receiving fax machine answers.

Send a fax from memory

You can scan a black-and-white fax into memory and then send the fax from memory. This feature is useful if the fax number you are trying to reach is busy or temporarily unavailable. The printer scans the originals into memory and sends them once it is able to connect to the receiving fax machine. After the printer scans the pages into memory, you can immediately remove the originals from the document feeder tray or scanner glass.

 **NOTE:** You can only send a black-and-white fax from memory.

To send a fax from memory

1. Load your original print-side down in the right-front corner of the glass or print-side up in the Automatic Document Feeder.
2. Touch **Fax**, and then touch **Settings**.
3. Touch **Scan and Fax**.

4.

Enter the fax number by using the keypad, touch  (Speed Dial) to select a speed dial, or touch



(Call History) to select a previously dialed or received number.

5. Touch **Start Fax**.

The printer scans the originals into memory and sends the fax when the receiving fax machine is available.

Schedule a fax to send later

You can schedule a black-and-white fax to be sent within the next 24 hours. This enables you to send a black-and-white fax late in the evening, when phone lines are not as busy or phone rates are lower, for example. The printer automatically sends your fax at the specified time.

You can only schedule one fax to be sent at a time. You can continue to send faxes normally, however, while a fax is scheduled.

 **NOTE:** You can only send scheduled faxes in black-and-white.

To schedule a fax from the printer control panel

1. Load your original print-side down in the right-front corner of the glass or print-side up in the Automatic Document Feeder.
2. Touch **Fax**, and then touch **Settings**.
3. Touch **Send Fax Later**.
4. Enter the send time by touching up and down arrows, touch **AM** or **PM**, and then touch **Done**.

5.

Enter the fax number by using the keypad, touch  (Speed Dial) to select a speed dial, or touch



(Call History) to select a previously dialed or received number.

6. Touch **Start Fax**.

The printer scans all pages and the scheduled time appears on the display. The fax is sent at the scheduled time.

To cancel a scheduled fax

1. Touch the **Fax**, then touch **Settings**.
2. Touch **Send Fax Later**.
3. Touch **Cancel Scheduled Fax**.

Send a fax in Error Correction Mode

Error Correction Mode (ECM) prevents loss of data due to poor phone lines by detecting errors that occur during transmission and automatically requesting retransmission of the erroneous portion. Phone charges are unaffected, or might even be reduced, on good phone lines. On poor phone lines, ECM increases sending time and phone charges, but sends the data much more reliably. The default setting is **On**. Turn ECM off only if it increases phone charges substantially, and if you can accept poorer quality in exchange for reduced charges.

Before turning the ECM setting off, consider the following. If you turn ECM off:

- The quality and transmission speed of faxes you send and receive are affected.
- The **Fax Speed** is automatically set to **Medium**.
- You can no longer send or receive faxes in color.

To change the ECM setting from the control panel

1. From the Home screen, touch **Settings**.
2. Touch **Fax Setup**, and then select **Advanced Fax Setup**.
3. Select **Error Correction Mode**.
4. Select **On** or **Off**.

Receive a fax

You can receive faxes automatically or manually. If you turn off the **Auto Answer** option, you must receive faxes manually. If you turn on the **Auto Answer** option (the default setting), the printer automatically answers incoming calls and receives faxes after the number of rings that are specified by the **Rings to Answer** setting. (The default **Rings to Answer** setting is five rings.)

If you receive a Legal-size or larger fax and the printer is not currently set to use Legal-size paper, the printer reduces the fax so that it fits on the paper that is loaded. If you have disabled the **Automatic Reduction** feature, the printer prints the fax on two pages.

 **NOTE:** If you are copying a document when a fax arrives, the fax is stored in the printer memory until the copying finishes. This can reduce the number of fax pages stored in memory.

- [Receive a fax manually](#)
- [Set up backup fax](#)
- [Reprint received faxes from memory](#)
- [Forward faxes to another number](#)
- [Set the paper size for received faxes](#)
- [Set automatic reduction for incoming faxes](#)
- [Block unwanted fax numbers](#)

Receive a fax manually

When you are on the phone, the person you are speaking with can send you a fax while you are still connected. This is referred to as manual faxing. Use the instructions in this section to receive a manual fax.

 **NOTE:** You can pick up the handset to talk or listen for fax tones.

You can receive faxes manually from a phone that is:

- Directly connected to the printer (on the 2-EXT port)
- On the same phone line, but not directly connected to the printer

To receive a fax manually

1. Make sure the printer is turned on and you have paper loaded in the main tray.
2. Remove any originals from the document feeder tray.
3. Set the **Rings to Answer** setting to a high number to allow you to answer the incoming call before the printer answers. Or, turn off the **Auto Answer** setting so that the printer does not automatically answer incoming calls.
4. If you are currently on the phone with the sender, instruct the sender to press **Start** on their fax machine.
5. When you hear fax tones from a sending fax machine, do the following:
 - a. Touch **Fax**, and then select **Receive Fax Manually**.
 - b. After the printer begins to receive the fax, you can hang up the phone or remain on the line. The phone line is silent during fax transmission.

Set up backup fax

Depending on your preference and security requirements, you can set up the printer to store all the faxes it receives, only the faxes it receives while the printer is in an error condition, or none of the faxes it receives.

The following backup fax modes are available:

| | |
|----------------------|---|
| On | <p>The default setting. When Backup Fax Reception is On, the printer stores all received faxes in memory. This enables you to reprint up to eight of the most recently printed faxes if they are still saved in memory.</p> <p>NOTE: 1 When printer memory is low, it overwrites the oldest, printed faxes as it receives new faxes. If the memory becomes full of unprinted faxes, the printer stops answering incoming fax calls.</p> <p>NOTE: 2 If you receive a fax that is too large, such as a very detailed color photo, it might not be stored in memory due to memory limitations.</p> |
| On Error Only | <p>Causes the printer to store faxes in memory only if an error condition exists that prevents the printer from printing the faxes (for example, if the printer runs out of paper). The printer continues to store incoming faxes as long as there is memory available. (If the memory becomes full, the printer stops answering incoming fax calls.) When the error condition is resolved, the faxes stored in memory print automatically, and then they are deleted from memory.</p> |
| Off | <p>Faxes are never stored in memory. For example, you might want to turn off Backup Fax Reception for security purposes. If an error condition occurs that prevents the printer from printing (for example, the printer runs out of paper), the printer stops answering incoming fax calls.</p> |

 **NOTE:** If **Backup Fax Reception** is enabled and you turn the printer off, all faxes stored in memory are deleted, including any unprinted faxes that you might have received while the printer was in an error condition. You must contact the senders to ask them to resend any unprinted faxes. For a list of the faxes you have received, print the **Fax Log**. The **Fax Log** is not deleted when the printer is turned off.

To set Backup Fax Reception from the printer control panel

1. From the Home screen, touch **Settings**.
2. Touch **Fax Setup**, and then select **Advanced Fax Setup**.
3. Touch **Backup Fax Reception**.
4. Touch **On**, **On Error Only**, or **Off**.

Reprint received faxes from memory

If you set the **Backup Fax Reception** mode to **On**, the received faxes are stored in memory, whether the printer has an error condition or not.

 **NOTE:** After the memory becomes full, the oldest, printed faxes are overwritten as new faxes are received. If all the stored faxes are unprinted, the printer does not receive any fax calls until you print or delete the faxes from memory. You might also want to delete the faxes in memory for security or privacy purposes.

Depending on the sizes of the faxes in memory, you can reprint up to eight of the most recently printed faxes, if they are still in memory. For example, you might need to reprint your faxes if you lost the copy of your last printout.

To reprint faxes in memory from the printer control panel

1. Make sure you have paper loaded in the main tray. For more information, see [Load media](#).
2. From the Home screen, touch the **Fax** icon.
3. Touch **Settings**, touch **Fax Tools**, and then select **Reprint Faxes in Memory**.
The faxes are printed in the reverse order from which they were received with the most recently received fax printed first, and so on.
4. If you want to stop reprinting the faxes in memory, touch **Cancel**.

Forward faxes to another number

You can set up the printer to forward your faxes to another fax number. A received color fax is forwarded in black and white.

HP recommends that you verify the number you are forwarding to is a working fax line. Send a test fax to make sure the fax machine is able to receive your forwarded faxes.

To forward faxes from the printer control panel

1. From the Home screen, touch **Settings**.
2. Touch **Fax Setup**, and then select **Advanced Fax Setup**.
3. Touch **Fax Forwarding**.
4. Touch **On (Print and Forward)** to print and forward the fax, or select **On (Forward)** to forward the fax.

 **NOTE:** If the printer is not able to forward the fax to the designated fax machine (for example, if it is not turned on), the printer prints the fax. If you set up the printer to print error reports for received faxes, it also prints an error report.

5. At the prompt, enter the number of the fax machine intended to receive the forwarded faxes, and then touch **Done**. Enter the required information for each of the following prompts: start date, start time, end date, and end time.
6. Fax forwarding is activated. Touch **OK** to confirm.
If the printer loses power when fax forwarding is set up, it saves the fax forwarding setting and phone number. When the power is restored to the printer, the fax forwarding setting is still **On**.

 **NOTE:** You can cancel fax forwarding by selecting **Off** from the **Fax Forwarding** menu.

Set the paper size for received faxes

You can select the paper size for received faxes. The paper size you select should match what is loaded in your main tray. Faxes can be printed on Letter, A4, or Legal paper only.

 **NOTE:** If an incorrect paper size is loaded in the main tray when you receive a fax, the fax does not print and an error message appears on the display. Load Letter, A4, or Legal paper, and then touch **OK** to print the fax.

To set the paper size for received faxes from the printer control panel

1. From the Home screen, touch **Settings**.
2. Touch **Fax Setup**, and then select **Basic Fax Setup**.
3. Touch **Fax Paper Size**, and then select an option.

Set automatic reduction for incoming faxes

The **Automatic Reduction** setting determines what the printer does if it receives a fax that is too large for the default paper size. This setting is turned on by default, so the image of the incoming fax is reduced to fit on one page, if possible. If this feature is turned off, information that does not fit on the first page is printed on a second page. **Automatic Reduction** is useful when you receive a Legal-size fax and Letter-size paper is loaded in the main tray.

To set automatic reduction from the printer control panel

1. From the Home screen, touch **Settings**.
2. Touch **Fax Setup**, and then select **Advanced Fax Setup**.
3. Touch **Automatic Reduction**, and then select **On** or **Off**.

Block unwanted fax numbers

If you subscribe to a caller ID service through your phone provider, you can block specific fax numbers so the printer does not print faxes received from those numbers. When an incoming fax call is received, the printer compares the number to the list of junk fax numbers to determine if the call should be blocked. If the number

matches a number in the blocked fax numbers list, the fax is not printed. (The maximum number of fax numbers you can block varies by model.)

 **NOTE: 1** This feature is not supported in all countries/regions. If it is not supported in your country/region, **Junk Fax Blocker** does not appear in the **Fax Options** or **Fax Settings** menu.

NOTE: 2 If no phone numbers are added in the Caller ID list, it is assumed that you are not subscribed to a Caller ID service.

- [Add numbers to the junk fax list](#)
- [Remove numbers from the junk fax list](#)
- [Print a Junk Fax Report](#)

Add numbers to the junk fax list

You can block specific numbers by adding them to the junk fax list.

To add a number to the junk fax list

1. From the Home screen, touch **Settings**.
2. Touch **Fax Setup**, and then select **Basic Fax Setup**.
3. Touch **Junk Fax Blocker**.
4. A message appears stating that Caller ID is required to block junk faxes. Touch **OK** to continue.
5. Touch **Add Numbers**.
6. To select a fax number to block from the caller ID list, touch **Select from Caller ID History**.
- or -
To manually enter a fax number to block, touch **Enter new number**.
7. After entering a fax number to block, touch **Done**.

 **NOTE:** Make sure you enter the fax number as it appears on the control panel display, and not the fax number that appears on the fax header of the received fax, as these numbers can be different.

Remove numbers from the junk fax list

If you no longer want to block a fax number, you can remove a number from your junk fax list.

To remove numbers from the list of junk fax numbers

1. From the Home screen, touch **Settings**.
2. Touch **Fax Setup**, and then touch **Basic Fax Setup**.
3. Touch **Junk Fax Blocker**.
4. Touch **Remove Numbers**.
5. Touch the number you want to remove, and then touch **OK**.

Print a Junk Fax Report

Use the following procedure to print a list of blocked junk fax numbers.

To print a Junk Fax Report

1. From the Home screen, touch **Settings**.
2. Touch **Fax Setup**, and then touch **Basic Fax Setup**.
3. Touch **Junk Fax Blocker**.
4. Touch **Print Reports**, and then touch **Junk Fax List**.

Set up speed-dial entries

You can set up frequently used fax numbers as speed-dial entries. This lets you dial those numbers quickly by using the printer's control panel.

 **TIP:** In addition to creating and managing speed-dial entries from the printer's control panel, you can also use tools available on your computer, such as the HP software included with the printer and the printer's embedded web server (EWS).

This section contains the following topics:

- [Set up and change speed-dial entries](#)
- [Delete speed-dial entries](#)
- [Print a list of speed-dial entries](#)

Set up and change speed-dial entries

You can store fax numbers as speed-dial entries.

To set up speed-dial entries

1. From the Home screen, touch **Settings**.
2. Touch **Fax Setup**, and then select **Speed Dial Setup**.
3. Touch **Add/Edit Speed Dial**, and then touch an unused entry number.
4. Type the fax number and a name, and then touch **Next**.

 **NOTE:** Be sure to include any pauses or other required numbers, such as an area code, an access code for numbers outside a PBX system (usually a 9 or 0), or a long-distance prefix.

5. Verify the information, and then touch **OK**.

To change speed-dial entries

1. From the Home screen, touch **Settings**.
2. Touch **Fax Setup**, and then select **Speed Dial Setup**.
3. Touch **Add/Edit Speed Dial**.
4. Make your changes in the fax number or the name, and then touch **Next**.

 **NOTE:** Be sure to include any pauses or other required numbers, such as an area code, an access code for numbers outside a PBX system (usually a 9 or 0), or a long-distance prefix.

Delete speed-dial entries

To delete speed-dial entries, complete the following steps:

1. From the Home screen, touch **Settings**.
2. Touch **Fax Setup**, and then touch **Speed Dial Setup**.
3. Touch **Delete Speed Dial**, touch the entry you want to delete, and then touch **Delete** to confirm.

Print a list of speed-dial entries

To print a list of all of the speed-dial entries that have been set up, complete the following steps:

1. Load paper in the tray. For more information, see [Load media](#).
2. From the Home screen, touch **Settings**.
3. Touch **Fax Setup**, and then touch **Speed Dial Setup**.
4. Touch **Print Speed Dial List**.

Change fax settings

After completing the steps in the getting started guide that came with the printer, use the following steps to change the initial settings or to configure other options for faxing.

- [Configure the fax header](#)
- [Set the answer mode \(Auto answer\)](#)
- [Set the number of rings before answering](#)

- [Change the answer ring pattern for distinctive ring](#)
- [Set the dial type](#)
- [Set the redial options](#)
- [Set the fax speed](#)
- [Set the fax sound volume](#)

Configure the fax header

The fax header prints your name and fax number on the top of every fax you send. HP recommends that you set up the fax header by using the HP software provided with the printer. You can also set up the fax header from the printer control panel, as described here.

 **NOTE:** In some countries/regions, the fax header information is a legal requirement.

To set or change the fax header

1. From the Home screen, touch **Settings**.
2. Touch **Fax Setup**, and then touch **Basic Fax Setup**.
3. Touch **Fax Header**.
4. Enter your personal or company name and fax number, and then touch **Done**.

Set the answer mode (Auto answer)

The answer mode determines whether the printer answers incoming calls.

- Turn on the **Auto Answer** setting if you want the printer to answer faxes **automatically**. The printer answers all incoming calls and faxes.
- Turn off the **Auto Answer** setting if you want to receive faxes **manually**. You must be available to respond in person to the incoming fax call or else the printer does not receive faxes.

To set the answer mode

1. From the Home screen, touch **Settings**.
2. Touch **Fax Setup**, and then touch **Basic Fax Setup**.
3. Touch **Auto Answer**, and then select **On** or **Off**.

Set the number of rings before answering

If you turn on the **Auto Answer** setting, you can specify how many rings occur before incoming calls are automatically answered.

The **Rings to Answer** setting is important if you have an answering machine on the same phone line as the printer, because you want the answering machine to answer the phone before the printer does. The number of rings to answer for the printer should be greater than the number of rings to answer for the answering machine.

For example, set your answering machine to a low number of rings and the printer to answer in the maximum number of rings. (The maximum number of rings varies by country/region.) In this setup, the answering machine answers the call and the printer monitors the line. If the printer detects fax tones, it receives the fax. If the call is a voice call, the answering machine records the incoming message.

To set the number of rings before answering

1. From the Home screen, touch **Settings**.
2. Touch **Fax Setup**, and then touch **Basic Fax Setup**.
3. Touch **Rings to Answer**.
4. Touch up and down arrows to change the number of rings.
5. Touch **Done** to accept the setting.

Change the answer ring pattern for distinctive ring

Many phone companies offer a distinctive ring feature that allows you to have several phone numbers on one phone line. When you subscribe to this service, each number is assigned a different ring pattern. You can set up the printer to answer incoming calls that have a specific ring pattern.

If you connect the printer to a line with distinctive ring, have your telephone company assign one ring pattern to voice calls and another ring pattern to fax calls. HP recommends that you request double or triple rings for a fax number. When the printer detects the specified ring pattern, it answers the call and receives the fax.

 **TIP:** You can also use the Ring Pattern Detection feature in the printer's control panel to set distinctive ring. With this feature, the printer recognizes and records the ring pattern of an incoming call and, based on this call, automatically determines the distinctive ring pattern assigned by your telephone company to fax calls.

If you do not have a distinctive ring service, use the default ring pattern, which is **All Rings**.

 **NOTE:** The printer cannot receive faxes when the main phone number is off the hook.

To change the answer ring pattern for distinctive ring

1. Verify that the printer is set to answer fax calls automatically.
2. From the Home screen, touch **Settings**.
3. Touch **Fax Setup**, and then select **Advanced Fax Setup**.
4. Touch **Distinctive Ring**.
5. A message appears stating that this setting should not be changed unless you have multiple numbers on the same telephone line. Touch **Yes** to continue.
6. Do one of the following:
 - Touch the ring pattern assigned by your telephone company to fax calls.
- Or -
 - Touch **Ring Pattern Detection**, and then follow the instructions on the printer's control panel.

 **NOTE: 1** If the Ring Pattern Detection feature cannot detect the ring pattern or if you cancel the feature before it finishes, the ring pattern is automatically set to the default, which is **All Rings**.

NOTE: 2 If you are using a PBX phone system that has different ring patterns for internal and external calls, you must call the fax number from an external number.

Set the dial type

Use this procedure to set tone-dialing or pulse-dialing mode. The factory-set default is **Tone**. Do not change the setting unless you know that your phone line cannot use tone dialing.

 **NOTE:** The pulse-dialing option is not available in all countries/regions.

To set the dial type

1. From the Home screen, touch **Settings**.
2. Touch **Fax Setup**, and then touch **Basic Fax Setup**.
3. Scroll down, and then touch **Dial Type**.
4. Touch to select **Tone Dialing** or **Pulse Dialing**.

Set the redial options

If the printer was unable to send a fax because the receiving fax machine did not answer or was busy, the printer attempts to redial based on the settings for the busy-redial and no-answer-redial options. Use the following procedure to turn the options on or off.

- **Busy redial:** If this option is turned on, the printer redials automatically if it receives a busy signal. The factory-set default for this option is **Redial**.
- **No answer redial:** If this option is turned on, the printer redials automatically if the receiving fax machine does not answer. The factory-set default for this option is **No Redial**.

To set the redial options

1. From the Home screen, touch the **Fax** icon.
2. Touch **Settings**, and then touch **Advanced Fax Setup**.
3. Touch **Busy Redial** or **No Answer Redial**, and then select the appropriate options.

Set the fax speed

You can set the fax speed used to communicate between your printer and other fax machines when sending and receiving faxes.

If you use one of the following, setting the fax speed to a slower speed might be required:

- An Internet phone service
- A PBX system
- Fax over Internet Protocol (FoIP)
- An integrated services digital network (ISDN) service

If you experience problems sending and receiving faxes, try using a lower **Fax Speed**. The following table provides the available fax speed settings.

| Fax speed setting | Fax speed |
|-------------------|------------------|
| Fast | v.34 (33600 bps) |
| Medium | v.17 (14400 bps) |
| Slow | v.29 (9600 bps) |

To set the fax speed

1. From the Home screen, touch the **Fax** icon.
2. Touch **Settings**, and then touch **Advanced Fax Setup**.
3. Touch **Fax Speed**.
4. Touch to select an option.

Set the fax sound volume

Use this procedure to increase or decrease the volume of the fax sounds.

To set the fax sound volume

1. From the Home screen, touch the **Fax** icon.
2. Touch **Settings**, and then touch **Basic Fax Setup**.
3. Touch **Fax Sound Volume**.
4. Touch to select **Soft**, **Loud**, or **Off**.

Fax and digital phone services

Many telephone companies provide their customers with digital phone services, such as the following:

- DSL: A Digital subscriber line (DSL) service through your telephone company. (DSL might be called ADSL in your country/region.)
- PBX: A private branch exchange (PBX) phone system.
- ISDN: An integrated services digital network (ISDN) system.
- FoIP: A low-cost phone service that allows you to send and receive faxes with your printer by using the Internet. This method is called Fax over Internet Protocol (FoIP). For more information, see [Fax over Internet Protocol](#).

HP printers are designed specifically for use with traditional analog phone services. If you are in a digital phone environment (such as DSL/ADSL, PBX, or ISDN), you might need to use digital-to-analog filters or converters when setting up the printer for faxing.

 **NOTE:** HP does not guarantee that the printer will be compatible with all digital service lines or providers, in all digital environments, or with all digital-to-analog converters. It is always recommended that you discuss with the telephone company directly for the correct setup options based on their line services provided.

Fax over Internet Protocol

You might be able to subscribe to a low cost phone service that allows you to send and receive faxes with your printer by using the Internet. This method is called Fax over Internet Protocol (FoIP).

You probably use a FoIP service (provided by your telephone company) when you:

- Dial a special access code along with the fax number, or
- Have an IP converter box that connects to the Internet and provides analog phone ports for the fax connection.

 **NOTE:** You can only send and receive faxes by connecting a phone cord to the port labeled "1-LINE" on the printer. This means that your connection to the Internet must be done either through a converter box (which supplies regular analog phone jacks for fax connections) or your telephone company.

 **TIP:** Support for traditional fax transmission over any Internet protocol telephone systems are often limited. If you experience problems faxing, try using a slower fax speed or disabling the fax error-correction mode (ECM). However, if you turn off ECM, you cannot send and receive color faxes. (For more information about changing the fax speed, see [Set the fax speed](#). For more information about using ECM, see [Send a fax in Error Correction Mode](#).)

If you have questions about Internet faxing, contact your Internet faxing services support department or your local service provider for further assistance.

Use reports

You can set up the printer to print error reports and confirmation reports automatically for each fax you send and receive. You can also manually print system reports as required; these reports provide useful system information about the printer.

By default, the printer is set to print a report only if there is a problem sending or receiving a fax. A confirmation message that indicates whether a fax was successfully sent appears briefly on the control panel display after each transaction.

 **NOTE: 1** If the reports are not legible, you can check the estimated ink levels from the control panel or the HP software.

NOTE: 2 Ink level alerts and indicators provide estimates for planning purposes only. When you receive a low-ink alert, consider having a replacement cartridge available to avoid possible printing delays. You do not need to replace the ink cartridges until prompted to do so.

NOTE: 3 Ensure that the printheads and ink cartridges are in good conditions and installed properly. For more information, see [Work with cartridges](#).

This section contains the following topics:

- [Print fax confirmation reports](#)
- [Print fax error reports](#)
- [Print and view the fax log](#)
- [Clear the fax log](#)
- [Print the details of the last fax transaction](#)
- [Print a Caller ID Report](#)
- [View the Call History](#)

Print fax confirmation reports

If you require printed confirmation that your faxes were successfully sent, follow these instructions to enable fax confirmation **before** sending any faxes. Select either **On (Fax Send)** or **On (Send and Receive)**.

The default fax confirmation setting is **On (Fax Send)**.

 **NOTE:** You can include an image of the first page of the fax on the Fax Sent Confirmation report if you select **On (Fax Send)** or **On (Send and Receive)**, and if you scan the fax to send from memory or use the **Scan and Fax** option.

To enable fax confirmation

1. From the Home screen, touch the **Fax** icon.
2. Touch **Settings**, and then touch **Fax Reports**.
3. Touch **Fax Confirmation**.
4. Touch to select one of the following options.

| | |
|------------------------------|--|
| Off | Does not print a fax confirmation report when you send and receive faxes successfully. |
| On (Fax Send) | Prints a fax confirmation report for every fax you send. This is the default setting. |
| On (Fax Receive) | Prints a fax confirmation report for every fax you receive. |
| On (Send and Receive) | Prints a fax confirmation report for every fax you send and receive. |

To include an image of the fax on the report

1. From the Home screen, touch the **Fax** icon.
2. Touch **Settings**, and then select **Fax Reports** and **Fax Confirmation**.
3. Touch **On (Fax Send)** or **On (Send and Receive)**.
4. Touch **Fax Confirmation with image**.

Print fax error reports

You can configure the printer so that it automatically prints a report when there is an error during transmission or reception.

To set the printer to print fax error reports automatically

1. From the Home screen, touch the **Fax** icon.
2. Touch **Settings**, and then touch **Fax Reports**.
3. Touch **Fax Error Report**.
4. Touch to select one of the following.

| | |
|------------------------------|--|
| On (Send and Receive) | Prints whenever a transmission error occurs. |
| Off | Does not print any fax error reports. |
| On (Fax Send) | Prints whenever a fax error occurs. This is the default setting. |
| On (Fax Receive) | Prints whenever a receiving error occurs. |

Print and view the fax log

You can print a log of faxes that have been received and sent by the printer.

To print the fax log from the printer control panel

1. From the Home screen, touch the **Fax** icon.
2. Touch **Settings**, and then touch **Fax Reports**.
3. Touch **Fax Log**.

Clear the fax log

Use the following steps to clear the fax log.

 **NOTE:** Clearing the fax log also deletes all faxes stored in memory.

To clear the fax log

1. From the Home screen, touch the **Fax** icon.
2. Touch **Settings**, and then touch **Fax Tools**.
3. Touch **Clear Fax Log**.

Print the details of the last fax transaction

The Last Fax Transaction report prints the details of the last fax transaction to occur. Details include the fax number, number of pages, and the fax status.

To print the Last Fax Transaction report

1. From the Home screen, touch the **Fax** icon.
2. Touch **Settings**, and then touch **Fax Reports**.
3. Touch **Last Transaction**.

Print a Caller ID Report

Use the following procedure to print a list of Caller ID fax numbers.

To print a Caller ID History Report

1. From the Home screen, touch the **Fax** icon.
2. Touch **Settings**, and then touch **Fax Reports**.
3. Touch **Caller ID Report**.

View the Call History

Use the following procedure to view a list of all the calls placed from the printer.

 **NOTE:** The call history cannot be printed. You can only view it from the printer's control panel display.

To view the Call History

1. From the Home screen, touch **Fax**.
2. 

Touch  (Call History).

8 Work with cartridges

- [Check the estimated ink levels](#)
- [Clean cartridges automatically](#)
- [Align printer](#)
- [Replace the cartridges](#)
- [Order ink supplies](#)
- [Cartridge warranty information](#)
- [Tips for working with ink](#)

Check the estimated ink levels

You can easily check the ink supply level to determine how soon you might need to replace a cartridge. The ink supply level shows an estimate of the amount of ink remaining in the cartridges.

 **NOTE: 1** If you have installed a refilled or remanufactured cartridge, or a cartridge that has been used in another printer, the ink level indicator might be inaccurate or unavailable.

NOTE: 2 Ink level warnings and indicators provide estimates for planning purposes only. When you receive a low-ink warning message, consider having a replacement cartridge available to avoid possible printing delays. You do not have to replace the cartridges until the print quality is unacceptable.

NOTE: 3 Ink from the cartridges is used in the printing process in a number of different ways, including in the initialization process, which prepares the product and cartridges for printing, and in printhead servicing, which keeps print nozzles clear and ink flowing smoothly. In addition, some residual ink is left in the cartridge after it is used. For more information, see www.hp.com/go/inkusage.

To check the ink levels from the printer display

- ▲ From the Home screen, press the **Ink Levels** icon. The estimated ink levels are displayed.

Related topics

- [Order ink supplies](#)
- [Tips for working with ink](#)

Clean cartridges automatically

If print quality is unacceptable, and the problem is not low ink levels or non-HP ink, try cleaning the cartridges.

To clean the cartridges from the printer display

1. From the Home screen, press the **Settings** icon. The **Settings Menu** is displayed.
2. Touch **Tools**.
3. Touch **Clean Cartridges**.

Related topics

- [Order ink supplies](#)
- [Tips for working with ink](#)

Align printer

After you insert new cartridges, align the printer for best print quality. You can align printer either from the printer display or from the printer software.

To align printer from the printer display

1. From the Home screen, touch the **Setup** icon, and then touch **Tools**.
2. On the **Tools** menu, touch and drag your finger vertically to scroll through the options, and then touch **Align Printer**.
3. Follow the instruction on the screen.

To align printer from the printer software

- ▲ Do one of the following according to the operating system you are using.

On Windows:

- a. From the **Start** menu on your computer, click **All Programs**, click **HP**.
- b. Click the **HP Photosmart 7520 Series** folder, click **HP Photosmart 7520 Series**.
- c. Under **Print**, double-click **Maintain Your Printer**.
- d. Under the **Device Services** tab, double-click **Align Printheads**.

On Mac:

- ▲ Open **HP Utility**, click **Align**, and then click **Align** again.

Related topics

- [Order ink supplies](#)
[Tips for working with ink](#)

Replace the cartridges

To replace the cartridges

1. Check that power is on.
2. Remove cartridge.
 - a. Open cartridge access door.



Wait for print carriage to move to center of product.

- b. Press tab on cartridge, then remove it from slot.

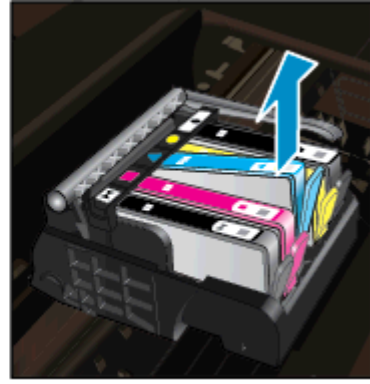
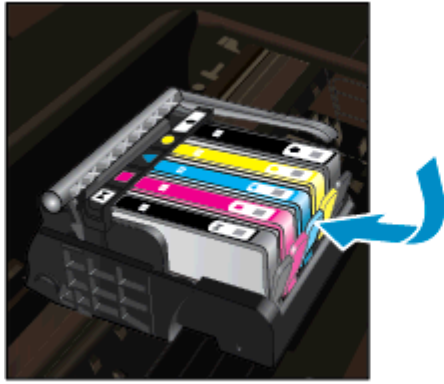

- 3. Insert new cartridge.
 - a. Remove cartridge from packaging.

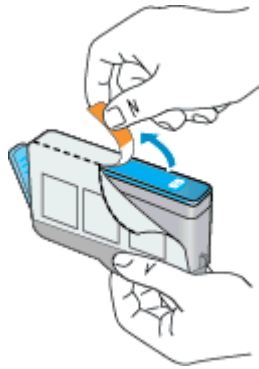

- b. Twist orange cap to snap it off. A forceful twist may be required to remove cap.



- c. Match color icons, then slide cartridge into slot until it clicks into place.

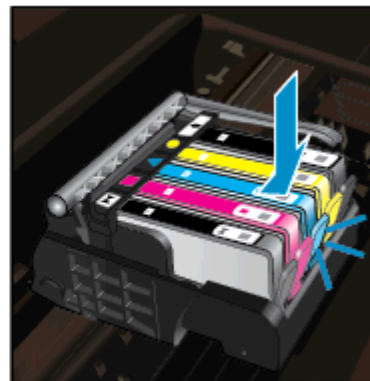
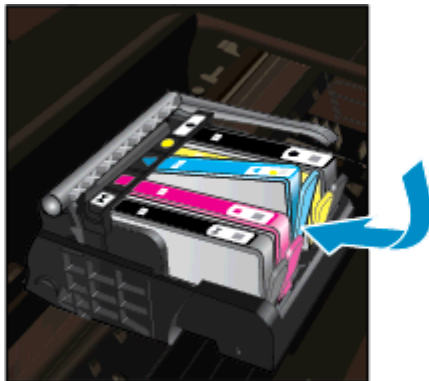

- d. Close cartridge door.



Related topics

- [Order ink supplies](#)
[Tips for working with ink](#)

Order ink supplies

To learn which HP supplies work with your product, order supplies online, or create a printable shopping list, open HP Solution Center, and select the online shopping feature.

Cartridge information and links to online shopping also appear on ink alert messages. In addition, you can find cartridge information and order online by visiting www.hp.com/buy/supplies.

 **NOTE:** Ordering cartridges online is not supported in all countries/regions. If it is not supported in your country/region, contact a local HP reseller for information about purchasing cartridges.

Cartridge warranty information

The HP cartridge warranty is applicable when the product is used in its designated HP printing device. This warranty does not cover HP ink products that have been refilled, remanufactured, refurbished, misused, or tampered with.

During the warranty period the product is covered as long as the HP ink is not depleted and the end of warranty date has not been reached. The end of warranty date, in YYYY/MM format, may be found on the product as indicated:

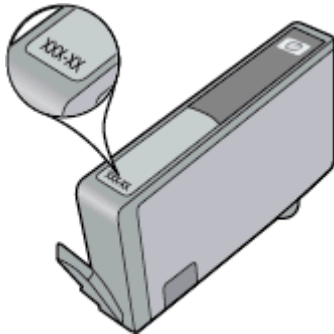

For a copy of the HP Limited Warranty Statement, see the printed documentation that came with the product.

Tips for working with ink

Use the following tips to work with ink cartridges:

- Use the correct ink cartridges for your printer. For a list of compatible ink cartridges, see the printed documentation that came with the printer.
- Insert the ink cartridges into the correct slots. Match the color and icon of each cartridge to the color and icon for each slot. Make sure all cartridges snap down into place.
- Use genuine HP ink cartridges. Genuine HP ink cartridges are designed for and tested with HP printers to help you produce great results, time after time.
- Consider getting replacement ink cartridges when you receive an ink alert message. This avoids possible printing delays. You do not need to replace the ink cartridges until print quality becomes unacceptable.

9 Connectivity

- [Add the HP Photosmart to a network](#)
- [Change from a USB connection to a wireless network](#)
- [Connect a new printer](#)
- [Change network settings](#)
- [Wireless Direct](#)
- [Tips for setting up and using a networked printer](#)
- [Advanced printer management tools \(for networked printers\)](#)

Add the HP Photosmart to a network

- [WiFi Protected Setup \(WPS\)](#)
- [Wireless with a router \(infrastructure network\)](#)

WiFi Protected Setup (WPS)

To connect the HP Photosmart to a wireless network using Wi-Fi Protected Setup (WPS), you will need the following:

- A wireless 802.11b/g/n network that includes a WPS-enabled wireless router or access point.

 **NOTE:** This product will only support 2.4GHz

- A desktop computer or laptop with either wireless networking support. The computer must be connected to the wireless network that you intend to install the HP Photosmart on.

 **NOTE: 1** If you have a Wi-Fi Protected Setup (WPS) router with a WPS push button, follow the **Push Button method**. If you are not certain your router has a push button, follow the **Wireless Settings Menu method**.

NOTE: 2 WPS should not be used if the network uses the default network name set by the manufacturer of the router and they are using no security encryption. In addition, WPS should not be used if WEP encryption is used.

Connect your printer using WiFi Protected Setup

-  View the animation for this topic. Some screens that appear in the animation may not reflect your product.

Push Button (PBC) method

1. Press the Wi-Fi Protected Setup (WPS) button on your router.
2. Press and hold the **Wireless** button on the printer until the wireless light starts blinking. Press and hold for 3 seconds to start WPS push button mode .

 **NOTE:** The product begins a timer for approximately two minutes while a wireless connection is established.

Wireless Settings Menu method

1. Touch the **Wireless** button on the printer display to see the Wireless menu. If the printer is printing, in an error state, or performing a critical task, wait until the task has been completed or the error cleared before pressing the **Wireless** button.
2. Select **Wireless Settings** from the printer display.
3. Select **Wi-Fi Protected Setup** from the printer display.
4. If you have a Wi-Fi Protected Setup (WPS) router with a WPS push button, select **Push Button**, and then follow the onscreen instructions. If your router does not have a push button or you are not certain if your router has a push button, select **PIN**, and then follow the onscreen instructions.

 **NOTE:** The product begins a timer for approximately two minutes during which the corresponding button on the networking device needs to be pressed or the router PIN needs to be entered on the router's configuration page.

Wireless with a router (infrastructure network)

To connect the HP Photosmart to an integrated wireless WLAN 802.11 network, you will need the following:

- ❑ A wireless 802.11b/g/n network that includes a wireless router or access point.

 **NOTE:** This product will only support 2.4Ghz

- ❑ A desktop computer or laptop with either wireless networking support, or a network interface card (NIC). The computer must be connected to the wireless network that you intend to install the HP Photosmart on.
- ❑ Network name (SSID).
- ❑ WEP key or WPA Passphrase (if needed).
- ❑ Broadband Internet access (recommended) such as cable or DSL.
If you connect the HP Photosmart on a wireless network that has Internet access, HP recommends that you use a wireless router (access point or base station) that uses Dynamic Host Configuration Protocol (DHCP).

To connect the product with the Wireless Setup Wizard

1. Write down your network name (SSID) and WEP key or WPA passphrase.
2. Start Wireless Setup Wizard.
 - a. From the Home screen on the printer display, touch the **Wireless** icon.
 - b. On the Wireless summary screen, touch **Settings** and then touch **Wireless Setup Wizard**.
3. Connect to wireless network.
 - ▲ Select your network from the list of detected networks.
4. Follow prompts.

Related topics

- [Tips for setting up and using a networked printer](#)

Change from a USB connection to a wireless network

If you first setup your printer and installed the software with a USB cable, directly connecting the printer to your computer, you can easily change to a wireless network connection. You will need a wireless 802.11b/g/n network that includes a wireless router or access point. Make sure your computer is connected to the same network to which you plan to connect the printer.

 **NOTE:** This product will only support 2.4Ghz

To change from a USB connection to a wireless network

Do one of the following according to your operating system.

1. On Windows:
 - a. From the **Start** menu on your computer, click **All Programs**, and then click **HP**.
 - b. Click **HP Photosmart 7520 Series**, click **Printer Setup & Software Selection**, and then click **Convert a USB connected printer to wireless**.
 - c. Follow the instructions on the screen.
2. On Mac:
 - a. Touch the **Wireless** icon, and then touch **Wireless Setup Wizard**.
 - b. Follow the instructions on the screen to connect the printer.
 - c. Use **HP Setup Assistant** in Applications/Hewlett-Packard/Device Utilities to change the software connection to this printer to wireless.

Connect a new printer

To connect a new printer from the printer software

If you have not finished connecting the printer to your computer using WPS, you need to connect it from the printer software. If you want to connect another new printer of the same model to your computer, you don't need to install the printer software once again. Do one of following according to your operating system:

1. On Windows:
 - a. From the **Start** menu on your computer, click **All Programs**, and then click **HP**.
 - b. Click **HP Photosmart 7520 Series**, click **Printer Setup and Software**, and then click **Connect a new printer**
 - c. Follow the instructions on the screen.
2. On Mac:
 - ▲ Use **HP Setup Assistant** in Applications/Hewlett-Packard/Device Utilities to change the software connection to this printer to wireless.

Change network settings

If you want to change the wireless settings that you previously configured to a network, you need to run the Wireless Setup Wizard from the printer display.

To run Wireless Setup Wizard to change network settings

1. From the Home screen on the printer display, touch the **Wireless** icon.
2. On the Wireless menu, touch **Settings** and then touch **Wireless Setup Wizard**.
3. Follow the instructions on the screen to change the network settings.

Wireless Direct

You can print directly to the printer wirelessly, without a wireless router, from your wireless-enabled computers and mobile devices with Wireless Direct.

To get started with Wireless Direct printing

- ▲ Turn on Wireless Direct from the control panel.
 - From the Home screen, touch the Wireless icon.
 - If Wireless Direct is turned off, touch Settings.
 - Touch Wireless Direct, touch On (No Security) or On (With Security).
 - If you turn on security, only users with the password can print wirelessly to the printer. If you turn off security, anyone with a Wi-Fi device within Wi-Fi range of the printer can connect to the printer.
 - Touch Display Name to display the Wireless Direct name.

From your wireless computer or mobile device, search for and connect to the Wireless Direct name, for example: HP-Print-xx-Photosmart-7520.

After you connect to Wireless Direct, you can use the installed printer software or a printing app for mobile devices to print to the printer.

Your printer can have a wireless connection to a wireless network and provide a Wireless Direct connection at the same time.

A maximum of five clients (computers or mobile devices) can connect to the wireless direct signal at a time.

Tips for setting up and using a networked printer

Use the following tips to set up and use a networked printer:

- When setting up the wireless networked printer, make sure your wireless router or access point is powered on. The printer searches for wireless routers, then lists the detected network names on the display.
- To verify the wireless connection, check the wireless icon at the top of the Home screen. If the icon is colored, the wireless connection is on. Touch the icon to display the Wireless status dashboard. Touch **Settings** to display the Network menu, with options for setting up a wireless connection or turning on the wireless connection, if already set up.
- If your computer is connected to a Virtual Private Network (VPN), you need to disconnect from the VPN before you can access any other device on your network., including the printer.
- Learn how to find your network security settings. [Click here to go online for more information.](#)
- Learn about the Network Diagnostic Utility and other troubleshooting tips. [Click here to go online for more information.](#)
- Learn how to change from a USB to wireless connection. [Click here to go online for more information.](#)
- Learn how to work with your firewall and anti-virus programs during printer setup. [Click here to go online for more information.](#)

Advanced printer management tools (for networked printers)

When the printer is connected to a network, you can use the embedded Web server to view status information, change settings, and manage the printer from your computer.

 **NOTE:** To view or change some settings, you might need a password.

You can open and use the embedded Web server without being connected to the Internet. However, some features are not available.

-
- [To open the embedded Web server](#)
 - [About cookies](#)

To open the embedded Web server

 **NOTE:** The printer must be on a network and must have an IP address. The IP address for the printer can be found by touching the **Wireless** button on the control panel or by printing a network configuration page.

In a supported Web browser on your computer, type the IP address or hostname that has been assigned to the printer.

For example, if the IP address is 192.168.0.12, type the following address into a Web browser such as Internet Explorer: `http://192.168.0.12`.

To access the embedded Web server your computer and your printer need to be on the same network.

About cookies

The embedded Web server (EWS) places very small text files (cookies) on your hard drive when you are browsing. These files let the EWS recognize your computer the next time you visit. For example, if you have configured the EWS language, a cookie helps remember which language you have selected so that the next time you access the EWS, the pages are displayed in that language. Though some cookies are cleared at the end of each session (such as the cookie that stores the selected language), others (such as the cookie that stores customer-specific preferences) are stored on the computer until you clear them manually.

You can configure your browser to accept all cookies, or you can configure it to alert you every time a cookie is offered, which allows you to decide which cookies to accept or refuse. You can also use your browser to remove unwanted cookies.

 **NOTE:** Depending on your printer, if you disable cookies, you also disable one or more of the following features:

- Starting where you left the application (especially useful when using setup wizards).
- Remembering the EWS browser language setting.
- Personalizing the EWS Home page.

For information about how to change your privacy and cookie settings and how to view or delete cookies, see the documentation available with your Web browser.

10 Solve a problem

- [Get more help](#)
- [Register the product](#)
- [Clear the paper jam](#)
- [Clear carriage jam](#)
- [Solve print problem](#)
- [Solve copy and scan problem](#)
- [Solve networking problem](#)
- [HP support by phone](#)
- [Additional warranty options](#)
- [Cartridge supply upgrade](#)
- [Prepare printer](#)
- [Check cartridge access door](#)
- [Printhead failure](#)
- [Printer failure](#)
- [Ink cartridge problem](#)
- [SETUP cartridges](#)

Get more help

You can find more information and help about your HP Photosmart by entering a keyword in the **Search** field in the top left of the help viewer. Titles of related topics -- for both local and online topics -- will be listed.

To contact HP Support, [click here to go online](#).

Register the product

By taking just a few quick minutes to register, you can enjoy quicker service, more efficient support, and product support alerts. If you did not register your printer while installing the software, you can register now at <http://www.register.hp.com>.

Clear the paper jam

- [Clearing paper jam from the two-sided printing accessory](#)
- [Clearing paper jam from the Automatic Document Feeder](#)

Clearing paper jam from the two-sided printing accessory

To clear a paper jam from the two-sided printing accessory.

1. Turn product off.
2. Remove the two-sided printing accessory.



3. Remove jammed paper.
4. Replace two-sided printing accessory.



5. Turn on product.
6. Try printing again.
7. View the animation for this topic. Some screens that appear in the animation may not reflect your product.

If the above solutions do not resolve the problem, [click here for more online troubleshooting](#).

Clearing paper jam from the Automatic Document Feeder

To clear a paper jam from the automatic document feeder

1. Turn product off.
2. Lift automatic document feeder mechanism.



3. Remove jammed paper.
4. Close automatic document feeder.
5. Turn on product.

If the above solutions do not resolve the problem, [click here for more online troubleshooting](#).

To clear a paper jam from the two-sided printing accessory.

1. Turn product off.
2. Remove the two-sided printing accessory.



3. Remove jammed paper.
4. Replace two-sided printing accessory.



5. Turn on product.
6. Try printing again.

Clear carriage jam

Remove any objects, such as paper, that are blocking the print carriage.

 **NOTE:** Do not use any tools or other devices to remove jammed paper. Always use caution when removing jammed paper from inside the printer.

To get help from the print display, touch **Help** from the Home screen. Touch **Troubleshooting and Support**, and then touch **How Do I...** Scroll through the topics and touch **Clear Carriage Jam**.

[Click here to go online for more information.](#)

Solve print problem

Make sure that the printer is turned on and that there is paper in the paper tray. If you are still unable to print, HP provides a Print Diagnostic Utility (Windows only) that can help solve many common “Unable to Print” issues. From the **Start** menu on your computer, click **All Programs**, and then click **HP**. Under **HP Photosmart 7520 Series**, click **HP Photosmart 7520 Series**, double-click **Print Actions**, and then double-click **HP Print Diagnostic Utility**.

[Click here to go online for more information.](#)

If print quality is not acceptable, try the following to improve print quality.

- Use printer status and print quality report to diagnose printer and print quality issues. From the Home screen, touch the **Settings** button, and then touch **Tools**. Scroll through options, and then touch **Printer Status Report** or **Print Quality Report**. [Click here to go online for more information](#)

Solve copy and scan problem

HP provides a Scan Diagnostic Utility (Windows only) that can help solve many common “Unable to scan” issues. From the **Start** menu on your computer, click **All Programs**, and then click **HP**. Under **HP Photosmart 7520 Series**, click **HP Photosmart 7520 Series**, double-click **Scanner Actions**, and then double-click **HP Scan Diagnostic Utility**.

Learn more about how to solve scan issues. [Click here to go online for more information](#)

Learn how to solve copy issues. [Click here to go online for more information.](#)

Solve networking problem

Check network configuration or print wireless test report to assist in diagnosing network connection issues.

To check network configuration or print wireless test report

1. From the Home screen, touch the **Wireless** icon, and then touch **Setup**.
2. Touch and drag your finger vertically to scroll through the options. Touch **Display Network Summary** or **Print Network Configuration Page**.

Click the links below to find more online information to solve networking issues.

- Learn more about wireless printing. [Click here to go online for more information.](#)
- Learn how to find your network security settings. [Click here to go online for more information.](#)
- Learn about the Network Diagnostic Utility (Windows only) and other troubleshooting tips. [Click here to go online for more information.](#)
- Learn how to work with your firewall and anti-virus programs during printer setup. [Click here to go online for more information.](#)

HP support by phone

Phone support options and availability vary by product, country/region, and language.

This section contains the following topics:

- [Phone support period](#)
- [Placing a call](#)
- [After the phone support period](#)

Phone support period

One year of phone support is available in North America, Asia Pacific, and Latin America (including Mexico). To determine the duration of phone support in Europe, the Middle East, and Africa, go to www.hp.com/support. Standard phone company charges apply.

Placing a call

Call HP support while you are in front of the computer and the product. Be prepared to provide the following information:

- Product name (HP Photosmart 7520 Series)
- Serial number (located on the back or bottom of the product)
- Messages that appear when the situation occurs
- Answers to these questions:
 - Has this situation happened before?
 - Can you re-create it?
 - Did you add any new hardware or software to your computer at about the time that this situation began?
 - Did anything else occur prior to this situation (such as a thunderstorm, product was moved, etc.)?

For the list of support phone numbers, visit www.hp.com/support.

After the phone support period

After the phone support period, help is available from HP at an additional cost. Help may also be available at the HP online support Web site: www.hp.com/support. Contact your HP dealer or call the support phone number for your country/region to learn more about support options.

Additional warranty options

Extended service plans are available for the HP Photosmart at additional costs. Go to www.hp.com/support, select your country/region and language, then explore the services and warranty area for information about the extended service plans.

Cartridge supply upgrade

If the supply upgrade is not successful, try getting your printer to recognize the supply upgrade cartridge.

To get the printer to recognize the supply upgrade cartridge:

1. Remove the supply upgrade cartridge.
2. Insert the original cartridge in the carriage.
3. Close the cartridge access door, then wait until the carriage stops moving.
4. Remove the original cartridge, then replace with the supply upgrade cartridge.
5. Close the cartridge access door, then wait until the carriage stops moving.

If you still receive a supply upgrade problem error message, contact HP support for help.

[Click here to go online for more information.](#)

Prepare printer

If you are not satisfied with the print quality, try cleaning the cartridges from the control panel. See [Clean cartridges automatically](#) for more information.

Check cartridge access door

The cartridge access door should be closed for printing.



[Click here to go online for more information.](#)

Printhead failure

The printhead in this product has failed. Contact HP support for help.

[Click here to go online for more information.](#)

Printer failure

If you have already turned the printer off and then on, and this does not solve your problem, contact HP support for help.

[Click here to go online for more information.](#)

Ink cartridge problem

To solve ink cartridge problem

1. Try removing and reinserting the cartridges. Make sure the cartridges are in the correct slots.
2. If reinserting the cartridges does not work, try cleaning cartridge contacts.

To clean cartridge contacts

⚠ CAUTION: The cleaning procedure should take only a few minutes. Make sure that the ink cartridges are reinstalled in the product as soon as possible. It is not recommended to leave the ink cartridges outside of the product longer than 30 minutes. This could result in damage to both the printhead and the ink cartridges.

- a. Check that power is on.
- b. Open the cartridge access door.



Wait for the print carriage to move to the middle of the product.

- c. Press tab on the cartridge indicated in the error message, then remove it from slot.

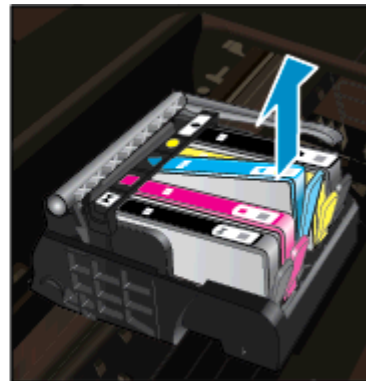
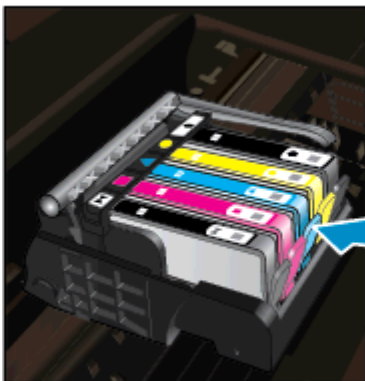

- d. Hold the ink cartridge by its sides with the bottom pointing up and locate the electrical contacts on the ink cartridge.

The electrical contacts are four small rectangles of copper or gold-colored metal on the bottom of the ink cartridge.

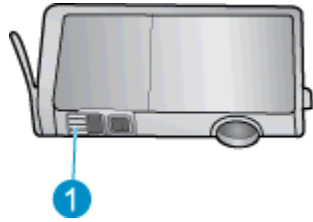

1 Electrical contacts

- e. Wipe only the contacts with a dry swab or lint-free cloth.

⚠ CAUTION: Be careful to touch only the contacts, and do not smear any of the ink or other debris elsewhere on the cartridge.

- f. On the inside of the product, locate the contacts in the printhead. The contacts look like a set of four copper or gold-colored pins positioned to meet the contacts on the ink cartridge.

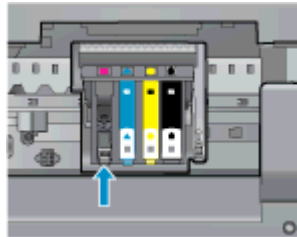

- g. Use a dry swab or lint-free cloth to wipe the contacts.
 - h. Reinstall the ink cartridge.
 - i. Close the access door, and check if the error message has gone away.
 - j. If you still receive the error message, turn the product off, and then on again.
3. If your problem is still not resolved, try replacing cartridges. See [Replace the cartridges](#) for more information.

[Click here to go online for more information.](#)

SETUP cartridges

When you first set up the printer, you must install the cartridges that shipped in the box with the printer. These cartridges are labeled SETUP, and they calibrate your printer before the first print job. Failure to install the SETUP cartridges during the initial product setup causes an error.

If you installed a set of regular cartridges, remove them and install the SETUP cartridges to complete printer setup. After printer setup is complete, the printer can use regular cartridges.

⚠ WARNING! You must replace the orange caps on the regular cartridges you remove, or they will quickly dry out. Some ink will still evaporate, but less than if the cartridges are uncapped. You can use the orange caps from the SETUP cartridges if necessary.

If you still receive the error message, contact HP support for help.

[Click here to go online for more information.](#)

Older generation cartridges

You will need to use a newer version of this cartridge. To identify a newer version of the cartridge, look at the exterior of the cartridge package and find the Warranty Ends date.

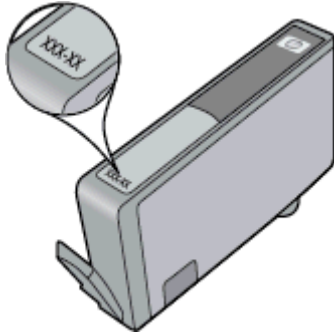

If it says 'v1' several spaces to the right of the date, then the cartridge is the updated newer version. If it is an older generation cartridge, contact HP support for help or replacement.

[Click here to go online for more information.](#)

11 Technical information

The technical specifications and international regulatory information for the HP Photosmart are provided in this section.

For additional specifications, see the printed documentation that came with the HP Photosmart.

This section contains the following topics:

- [Notice](#)
- [Cartridge chip information](#)
- [Specifications](#)
- [Environmental product stewardship program](#)
- [Regulatory notices](#)

Notice

Hewlett-Packard Company notices

The information contained in this document is subject to change without notice.

All rights reserved. Reproduction, adaptation, or translation of this material is prohibited without prior written permission of Hewlett-Packard, except as allowed under copyright laws. The only warranties for HP products and services are set forth in the express warranty statements accompanying such products and services. Nothing herein should be construed as constituting an additional warranty. HP shall not be liable for technical or editorial errors or omissions contained herein.

© 2012 Hewlett-Packard Development Company, L.P.

Microsoft, Windows, Windows XP, and Windows Vista are U.S. registered trademarks of Microsoft Corporation.

Windows 7 is either a registered trademark or trademark of Microsoft Corporation in the United States and/or other countries.

Intel and Pentium are trademarks or registered trademarks of Intel Corporation or its subsidiaries in the United States and other countries.

Adobe® is a trademark of Adobe Systems Incorporated.

Cartridge chip information

The HP cartridges used with this product contain a memory chip that assists in the operation of the product. In addition, this memory chip collects a limited set of information about the usage of the product, which might include the following: the date when the cartridge was first installed, the date when the cartridge was last used, the number of pages printed using the cartridge, the page coverage, the printing modes used, any printing errors that might have occurred, and the product model. This information helps HP design future products to meet our customers printing needs.

The data collected from the cartridge memory chip does not contain information that can be used to identify a customer or user of the cartridge or their product.

HP collects a sampling of the memory chips from cartridges returned to HP's free return and recycling program (HP Planet Partners: www.hp.com/hpinfo/globalcitizenship/environment/recycle/). The memory chips from this sampling are read and studied in order to improve future HP products. HP partners who assist in recycling this cartridge might have access to this data, as well.

Any third party possessing the cartridge might have access to the anonymous information on the memory chip. If you prefer to not allow access to this information, you can render the chip inoperable. However, after you render the memory chip inoperable, the cartridge cannot be used in an HP product.

If you are concerned about providing this anonymous information, you can make this information inaccessible by turning off the memory chip's ability to collect the product's usage information.

To disable the usage information function

1. Touch **Setup**.



2. Touch **Preferences**.
3. Touch **Cartridge Chip Info**, and then touch **On** or **Off**.

 **NOTE:** To re-enable the usage information function, restore the factory defaults.

 **NOTE:** You can continue to use the cartridge in the HP product if you turn off the memory chip's ability to collect the product's usage information.

Specifications

Technical specifications for the HP Photosmart are provided in this section. For complete product specifications, see the Product Data Sheet at www.hp.com/support.

System requirements

Software and system requirements are located in the Readme file.

For information about future operating system releases and support, visit the HP online support Web site at www.hp.com/support.

Environmental specifications

- Allowable operating temperature range: Main printer: 5 to 40 degrees C (41 to 104 degrees F) Removable display: -10 to 40 degrees C (14 to 104 degrees F)
- Allowable operating temperature range: 5 °C to 40 °C (41 °F to 104 °F)
- Humidity: 15% to 80% RH non-condensing; 28 °C maximum dewpoint
- Non-operating (Storage) temperature range: -20 to 60 degrees C (-4 to 140 degrees F)
- In the presence of high electromagnetic fields, it is possible the output from the HP Photosmart may be slightly distorted
- HP recommends using a USB cable less than or equal to 3 m (10 feet) in length to minimize injected noise due to potential high electromagnetic fields

Print resolution

To learn more about the printer resolution, see the printer software.

Paper specifications

| Type | Paper weight | Input tray [†] | Output tray [†] | Photo tray [†] |
|-------------------------------------|----------------------------------|--------------------------|--------------------------|-------------------------|
| Plain paper | 16 to 24 lb. (60 to 90 gsm) | Up to 125 (20 lb. paper) | 50 (20 lb. paper) | n/a |
| Legal paper | 16 to 24 lb. (60 to 90 gsm) | Up to 125 (20 lb. paper) | 10 (20 lb. paper) | n/a |
| Cards | Up to 75 lb. (281 gsm) | Up to 60 | 25 | Up to 20 |
| Envelopes | 20 to 24 lb. (75 to 90 gsm) | Up to 15 | 15 | n/a |
| Transparency film | n/a | Up to 40 | 25 | n/a |
| Labels | n/a | Up to 40 | 25 | n/a |
| 5 x 7 inch (13 x 18 cm) Photo paper | Up to 75 lb (281 gsm) (236 gsm) | Up to 40 | 25 | Up to 20 |
| 4 x 6 inch (10 x 15 cm) Photo paper | Up to 75 lb. (281 gsm) (236 gsm) | Up to 40 | 25 | Up to 20 |

(continued)

| Type | Paper weight | Input tray* | Output tray† | Photo tray* |
|---|------------------------|-------------|--------------|-------------|
| 8.5 x 11 inch (216 x 279 mm) Photo paper | Up to 75 lb. (281 gsm) | Up to 40 | 25 | n/a |

* Maximum capacity.

† Output tray capacity is affected by the type of paper and the amount of ink you are using. HP recommends emptying the output tray frequently. FAST DRAFT print quality mode requires the extender tray to be extended and the end tray rotated up. Without the end tray rotated up, both letter and legal-sized paper will fall on the first sheet.

*

 **NOTE:** For a complete list of supported media sizes, see the printer driver.

Two-sided printing accessory paper specifications - all regions except Japan

| Type | Size | Weight |
|----------------|---|-----------------------------|
| Paper | Letter: 8.5 x 11 inches Executive: 7.25 x 10.5 inches A4: 210 x 297 mm B5 (ISO): 176 x 250 mm B5 (JIS): 182 x 257 mm | 16 to 24 lb. (60 to 90 gsm) |
| Brochure paper | Letter: 8.5 x 11 inches A4: 210 x 297 mm | Up to 48 lb. (180 gsm) |

Print specifications

- Print speeds vary according to the complexity of the document
- Panorama-size printing
- Method: drop-on-demand thermal inkjet
- Language: PCL3 GUI

Copy specifications

- Digital image processing
- Maximum number of copies varies by model
- Copy speeds vary according to the complexity of the document and model
- Maximum copy enlargement ranging from 200-400% (depends on model)
- Maximum copy reduction ranging from 25-50% (depends on model)

Ink cartridge yield

Visit www.hp.com/go/learnaboutsupplies for more information on estimated cartridge yields.

Scan specifications

- Image editor included
- Resolution: up to 1200 x 2400 ppi optical (depends on model); 19200 ppi enhanced (software)
For more information about ppi resolution, see the scanner software.
- Color: 48-bit color, 8-bit grayscale (256 levels of gray)
- Maximum scan size from glass: 21.6 x 29.7 cm (8.5 x 11.7 inches)

Environmental product stewardship program

Hewlett-Packard is committed to providing quality products in an environmentally sound manner. Design for recycling has been incorporated into this product. The number of materials has been kept to a minimum while ensuring proper functionality and reliability. Dissimilar materials have been designed to separate easily. Fasteners and other connections are easy to locate, access, and remove using common tools. High priority parts have been designed to access quickly for efficient disassembly and repair.

For more information, visit HP's Commitment to the Environment Web site at:

www.hp.com/hpinfo/globalcitizenship/environment/index.html

This section contains the following topics:

- [Eco-Tips](#)
- [Paper use](#)
- [Plastics](#)
- [Material safety data sheets](#)
- [Recycling program](#)
- [HP inkjet supplies recycling program](#)
- [Auto Power-Off](#)
- [Set the Energy Save Mode](#)
- [Power consumption](#)
- [Disposal of waste equipment by users in private households in the European Union](#)
- [Chemical Substances](#)
- [Restriction of hazardous substance \(Ukraine\)](#)
- [Battery disposal in the Netherlands](#)
- [Battery disposal in Taiwan](#)
- [California Perchlorate Material Notice](#)
- [EU battery directive](#)

Eco-Tips

HP is committed to helping customers reduce their environmental footprint. HP has provided the Eco-Tips below to help you focus on ways to assess and reduce the impact of your printing choices. In addition to specific features in this product, please visit the HP Eco Solutions web site for more information on HP's environmental initiatives.

www.hp.com/hpinfo/globalcitizenship/environment/

Your product's Eco features

- **Energy Savings information:** To determine the ENERGY STAR® qualification status for this product, see [Power consumption](#).
- **Recycled Materials:** For more information regarding recycling of HP products, please visit: www.hp.com/hpinfo/globalcitizenship/environment/recycle/

Paper use

This product is suited for the use of recycled paper according to DIN 19309 and EN 12281:2002.

Plastics

Plastic parts over 25 grams are marked according to international standards that enhance the ability to identify plastics for recycling purposes at the end of product life.

Material safety data sheets

Material safety data sheets (MSDS) can be obtained from the HP Web site at:

www.hp.com/go/msds

Recycling program

HP offers an increasing number of product return and recycling programs in many countries/regions, and partners with some of the largest electronic recycling centers throughout the world. HP conserves resources by reselling some of its most popular products. For more information regarding recycling of HP products, please visit:

www.hp.com/hpinfo/globalcitizenship/environment/recycle/

HP inkjet supplies recycling program

HP is committed to protecting the environment. The HP Inkjet Supplies Recycling Program is available in many countries/regions, and lets you recycle used print cartridges and ink cartridges free of charge. For more information, go to the following Web site:

www.hp.com/hpinfo/globalcitizenship/environment/recycle/

Auto Power-Off

Auto Power-Off is automatically enabled by default when you turn on the printer. When Auto Power-Off is enabled, the printer will automatically turn off after two hours of inactivity to help reduce energy use. Auto Power-Off is automatically disabled when the printer establishes a wireless connection with a network router or with a mobile device for Wireless Direct printing, or when you enable alarms or calendar reminders. You can change the Auto Power-Off setting from the control panel. Once you change the setting, the printer will maintain the setting that you choose. **Auto Power-Off turns the printer off completely, so you must use the power button to turn the printer back on.**

To enable or disable Auto Power-Off

1. From the Home screen, touch **Setup**.

2. Touch **Preferences**.
3. Scroll through the options, and then touch **Set Auto-off**.
4. Touch **On** or **Off**.
5. Touch **Yes** to confirm your selection or **No** to keep your current setting.

 **TIP:** If you are printing through a wireless connection over a network, Auto Power-Off should be disabled to ensure that print jobs do not get lost. Even when Auto Power-Off is disabled, the user-adjustable Energy Saver Mode helps reduce energy use.

Set the Energy Save Mode

The HP Photosmart Energy Save Mode reduces energy use by entering a sleep mode after 5 minutes of inactivity. The time to sleep mode can be extended to 10 or 15 minutes.

 **NOTE:** This feature is on by default and cannot be turned off.

To set Energy Save Mode

1. Touch the Setup icon.

2. Touch **Preferences**.
3. Scroll through the options and touch **Energy Save Mode**.
4. Touch the desired time interval (5, 10 or 15 minutes).

Power consumption

Hewlett-Packard printing and imaging equipment marked with the ENERGY STAR® logo is qualified to the U.S. Environmental Protection Agency's ENERGY STAR specifications for imaging equipment. The following mark will appear on ENERGY STAR qualified imaging products:



Additional ENERGY STAR qualified imaging product model information is listed at: www.hp.com/go/energystar

Parliament and the Council). A chemical information report for this product can be found at: www.hp.com/go/reach.

Restriction of hazardous substance (Ukraine)

Технічний регламент щодо обмеження використання небезпечних речовин (Україна)

Обладнання відповідає вимогам Технічного регламенту щодо обмеження використання деяких небезпечних речовин в електричному та електронному обладнанні, затвердженого постановою Кабінету Міністрів України від 3 грудня 2008 № 1057

Battery disposal in the Netherlands



Dit HP Product bevat een lithium-manganees-dioxide batterij. Deze bevindt zich op de hoofdprintplaat. Wanneer deze batterij leeg is, moet deze volgens de geldende regels worden afgevoerd.

Battery disposal in Taiwan



廢電池請回收

Please recycle waste batteries.

California Perchlorate Material Notice

California Perchlorate Material Notice

Perchlorate material - special handling may apply. See: <http://www.dtsc.ca.gov/hazardouswaste/perchlorate/>

This product's real-time clock battery or coin cell battery may contain perchlorate and may require special handling when recycled or disposed of in California.

EU battery directive



| | |
|-------------|---|
| English | <p>European Union Battery Directive This product contains a battery that is used to maintain data integrity of real time clock or product settings and is designed to last the life of the product. Any attempt to service or replace this battery should be performed by a qualified service technician.</p> |
| Français | <p>Directive sur les batteries de l'Union Européenne Ce produit contient une batterie qui permet de maintenir l'intégrité des données pour les paramètres du produit ou l'horloge en temps réel et qui a été conçue pour durer aussi longtemps que le produit. Toute tentative de réparation ou de remplacement de cette batterie doit être effectuée par un technicien qualifié.</p> |
| Deutsch | <p>Batterie-Richtlinie der Europäischen Union Dieses Produkt enthält eine Batterie, die dazu dient, die Datenintegrität der Echtzeituhr sowie der Produkteinstellungen zu erhalten, und die für die Lebensdauer des Produkts ausreicht. Im Bedarfsfall sollte das Instandhalten bzw. Austauschen der Batterie von einem qualifizierten Servicetechniker durchgeführt werden.</p> |
| Italiano | <p>Direttiva dell'Unione Europea relativa alla raccolta, al trattamento e allo smaltimento di batterie e accumulatori Questo prodotto contiene una batteria utilizzata per preservare l'integrità dei dati dell'orologio in tempo reale o delle impostazioni del prodotto e la sua durata si intende pari a quella del prodotto. Eventuali interventi di riparazione o sostituzione della batteria devono essere eseguiti da un tecnico dell'assistenza qualificato.</p> |
| Español | <p>Directiva sobre baterías de la Unión Europea Este producto contiene una batería que se utiliza para conservar la integridad de los datos del reloj de tiempo real o la configuración del producto y está diseñada para durar toda la vida útil del producto. El mantenimiento o la sustitución de dicha batería deberá realizarla un técnico de mantenimiento cualificado.</p> |
| Česky | <p>Směrnice Evropské unie pro nakládání s bateriemi Tento výrobek obsahuje baterii, která slouží k uchování správných dat hodin reálného času nebo nastavení výrobku. Baterie je navržena tak, aby vydržela celou životnost výrobku. Jakýkoliv pokus o opravu nebo výměnu baterie by měl provést kvalifikovaný servisní technik.</p> |
| Dansk | <p>EU's batteridirektiv Produktet indeholder et batteri, som bruges til at vedligeholde dataintegriteten for realtidsur- eller produktindstillinger og er beregnet til at holde i hele produktets levetid. Service på batteriet eller udskiftning bør foretages af en uddannet servicetekniker.</p> |
| Nederlands | <p>Richtlijn batterijen voor de Europese Unie Dit product bevat een batterij die wordt gebruikt voor een juiste tijdsaanduiding van de klok en het behoud van de productinstellingen. Bovendien is deze ontworpen om gedurende de levensduur van het product mee te gaan. Het onderhoud of de vervanging van deze batterij moet door een gekwalificeerde onderhoudstechnicus worden uitgevoerd.</p> |
| Eesti | <p>Euroopa Liidu aku direktiiv Toode sisaldab akut, mida kasutatakse reaalaja kella andmeiltsuse või toote sätete säilitamiseks. Aku on valmistatud kestma terve toote kasutusaja. Akut tohib hooldada või vahetada ainult kvalifitseeritud hooldustehnik.</p> |
| Suomi | <p>Euroopan unionin paristodirektiivi Tämä laite sisältää pariston, jota käytetään reaaliaikaisen kellon tietojen ja laitteen asetusten säilyttämiseen. Pariston on suunniteltu kestäväin laitteen koko käyttöiän ajan. Pariston mahdollinen korjaus tai vaihto on jätettävä päteväin huoltohenkilön tehtäväksi.</p> |
| Ελληνικά | <p>Οδηγία της Ευρωπαϊκής Ένωσης για τις ηλεκτρικές στήλες Αυτό το προϊόν περιλαμβάνει μια μπαταρία, η οποία χρησιμοποιείται για τη διατήρηση της ακεραιότητας των δεδομένων ρολογιού πραγματικού χρόνου ή των ρυθμίσεων προϊόντος και έχει σχεδιαστεί έτσι ώστε να διαρκέσει όσο και το προϊόν. Τυχόν απόπειρες επιδιόρθωσης ή αντικατάστασης αυτής της μπαταρίας θα πρέπει να πραγματοποιούνται από κατάλληλα εκπαιδευμένο τεχνικό.</p> |
| Magyar | <p>Az Európai unió telepek és akkumulátorok direktívája A termék tartalmaz egy elemet, melynek feladata az, hogy biztosítsa a valós idejű óra vagy a termék beállításainak adatintegritását. Az elem úgy van tervezve, hogy végig kitartsa a termék használatá során. Az elem bármilyen javítását vagy cseréjét csak képzett szakember végezheti el.</p> |
| Latvian | <p>Eiropas Savienības Bateriju direktīva Produktam ir baterija, ko izmanto reālā laikā pulksteņa vai produkta iestatījumu datu integritātes saglabāšanai, un tā ir paredzēta visam produkta dzīves ciklam. Jebkura apkope vai baterijas nomaiņa ir jāveic atbilstoši kvalificētam darbiniekam.</p> |
| Lietuvai | <p>Europos Sąjungos baterijų ir akumuliatorių direktyva Šiame gaminyje yra baterija, kuri naudojama, kad būtų galima prižiūrėti realaus laiko laikrodžio veikimą arba gaminio nuostatas; ji skirta veikti visą gaminio eksploatavimo laiką. Bet kokius šios baterijos aptarnavimo arba keitimo darbus turi atlikti kvalifikuotas aptarnavimo technikas.</p> |
| Polski | <p>Dyrektywa Unii Europejskiej w sprawie baterii i akumulatorów Produkt zawiera baterię wykorzystywaną do zachowania integralności danych zegara czasu rzeczywistego lub ustawień produktu, która podtrzymuje działanie produktu. Przegląd lub wymiana baterii powinny być wykonywane wyłącznie przez uprawnionego technika serwisu.</p> |
| Português | <p>Directiva sobre baterias da União Europeia Este produto contém uma bateria que é usada para manter a integridade dos dados do relógio em tempo real ou das configurações do produto e é projetada para ter a mesma duração que este. Qualquer tentativa de consertar ou substituir essa bateria deve ser realizada por um técnico qualificado.</p> |
| Slovenščina | <p>Smernica Evropske unije pre zaobhădzanje s baterijami Tento výrobek obsahuje bateriju, ktorá slúži na uchovanie správnych údajov hodín reálného času alebo nastavení výrobku. Batéria je skonštruovaná tak, aby vydržala celú životnosť výrobku. Akýkoľvek pokus o opravu alebo výmenu batérie by mal vykonať kvalifikovaný servisný technik.</p> |
| Slovenščina | <p>Directiva Evropske unije o baterijah in akumulatorjih V tem izdelku je baterija, ki zagotavlja natančnost podatkov ure v realnem času ali nastavitve izdelka v celotni življenjski dobi izdelka. Kakršno koli popravilo ali zamenjavo te baterije lahko izvede le pooblaščen tehnik.</p> |
| Svenska | <p>EU:s batteridirektiv Produkten innehåller ett batteri som används för att upprätthålla data i realtidsklockan och produktinställningarna. Batteriet ska räkna produktens hela livslängd. Endast kvalificerade servicetekniker får utföra service på batteriet och byta ut det.</p> |
| Български | <p>Директива за батерии на Европейския съюз Този продукт съдържа батерия, която се използва за поддържане на целостта на данните на часовника в реално време или настройките за продукта, създадена на издръжливост през целия живот на продукта. Сервизът или замената на батерията трябва да се извършва от квалифициран техник.</p> |
| Română | <p>Directiva Uniunii Europene referitoare la baterii Acest produs conține o baterie care este utilizată pentru a menține integritatea datelor ceasului de timp real sau setărilor produsului și care este proiectată să funcționeze pe întreaga durată de viață a produsului. Orice lucrare de service sau de înlocuire a acestei baterii trebuie efectuată de un tehnician de service calificat.</p> |

Regulatory notices

The HP Photosmart meets product requirements from regulatory agencies in your country/region.

This section contains the following topics:

- [Regulatory model identification number](#)
- [FCC statement](#)
- [VCCI \(Class B\) compliance statement for users in Japan](#)
- [Notice to users in Japan about the power cord](#)
- [Notice to users in Korea](#)
- [Notice to users in Germany](#)
- [Noise emission statement for Germany](#)
- [European Union Regulatory Notice](#)
- [Regulatory telecommunication notices](#)
- [Regulatory wireless statements](#)

Regulatory model identification number

For regulatory identification purposes, your product is assigned a Regulatory Model Number. The Regulatory Model Number for your product is SDGOB-1221. This regulatory number should not be confused with the marketing name (HP Photosmart 7520 Series, etc.) or product numbers (CZ045A, etc.).

FCC statement

FCC statement

The United States Federal Communications Commission (in 47 CFR 15.105) has specified that the following notice be brought to the attention of users of this product.

This equipment has been tested and found to comply with the limits for a Class B digital device, pursuant to Part 15 of the FCC Rules. These limits are designed to provide reasonable protection against harmful interference in a residential installation. This equipment generates, uses and can radiate radio frequency energy and, if not installed and used in accordance with the instructions, may cause harmful interference to radio communications. However, there is no guarantee that interference will not occur in a particular installation. If this equipment does cause harmful interference to radio or television reception, which can be determined by turning the equipment off and on, the user is encouraged to try to correct the interference by one or more of the following measures:

- Reorient the receiving antenna.
- Increase the separation between the equipment and the receiver.
- Connect the equipment into an outlet on a circuit different from that to which the receiver is connected.
- Consult the dealer or an experienced radio/TV technician for help.

For further information, contact:

Manager of Corporate Product Regulations
Hewlett-Packard Company
3000 Hanover Street
Palo Alto, Ca 94304
(650) 857-1501

Modifications (part 15.21)

The FCC requires the user to be notified that any changes or modifications made to this device that are not expressly approved by HP may void the user's authority to operate the equipment.

This device complies with Part 15 of the FCC Rules. Operation is subject to the following two conditions: (1) this device may not cause harmful interference, and (2) this device must accept any interference received, including interference that may cause undesired operation.

VCCI (Class B) compliance statement for users in Japan

この装置は、クラスB情報技術装置です。この装置は、家庭環境で使用することを目的としていますが、この装置がラジオやテレビジョン受信機に近接して使用されると、受信障害を引き起こすことがあります。取扱説明書に従って正しい取り扱いをして下さい。

VCCI-B

Notice to users in Japan about the power cord

製品には、同梱された電源コードをお使い下さい。
同梱された電源コードは、他の製品では使用出来ません。

Notice to users in Korea

| | |
|------------------------|--|
| B 급 기기 (가정용 방송통신기기) | 이 기기는 가정용(B급)으로 전자파적합등록을 한 기기로서 주로 가정에서 사용하는 것을 목적으로 하며, 모든 지역에서 사용할 수 있습니다. |
|------------------------|--|

Notice to users in Germany

GS-Erklärung (Deutschland)

Das Gerät ist nicht für die Benutzung im unmittelbaren Gesichtsfeld am Bildschirmarbeitsplatz vorgesehen. Um störende Reflexionen am Bildschirmarbeitsplatz zu vermeiden, darf dieses Produkt nicht im unmittelbaren Gesichtsfeld platziert werden.

Noise emission statement for Germany

Geräuschemission

LpA < 70 dB am Arbeitsplatz im Normalbetrieb nach DIN 45635 T. 19

European Union Regulatory Notice

Products bearing the CE marking comply with the following EU Directives:

- Low Voltage Directive 2006/95/EC
- EMC Directive 2004/108/EC
- Ecodesign Directive 2009/125/EC, where applicable



CE compliance of this product is valid only if powered with the correct CE-marked AC adapter provided by HP.

If this product has telecommunications functionality, it also complies with the essential requirements of the following EU Directive:

- R&TTE Directive 1999/5/EC

Compliance with these directives implies conformity to applicable harmonized European standards (European Norms) that are listed in the EU Declaration of Conformity issued by HP for this product or product family and available (in English only) either within the product documentation or at the following web site: www.hp.com/go/certificates (type the product number in the search field).

The compliance is indicated by one of the following conformity markings placed on the product:

| | |
|---|--|
|  | For non-telecommunications products and for EU harmonized telecommunications products, such as Bluetooth® within power class below 10mW. |
|  | For EU non-harmonized telecommunications products (If applicable, a 4-digit notified body number is inserted between CE and !). |

Please refer to the regulatory label provided on the product.

The telecommunications functionality of this product may be used in the following EU and EFTA countries: Austria, Belgium, Bulgaria, Cyprus, Czech Republic, Denmark, Estonia, Finland, France, Germany, Greece, Hungary, Iceland, Ireland, Italy, Latvia, Liechtenstein, Lithuania, Luxembourg, Malta, Netherlands, Norway, Poland, Portugal, Romania, Slovak Republic, Slovenia, Spain, Sweden, Switzerland, and United Kingdom.

The telephone connector (not available for all products) is intended for connection to analogue telephone networks.

Products with wireless LAN devices

- Some countries may have specific obligations or special requirements about the operation of Wireless LAN networks such as indoor use only or restrictions of the channels available. Please make sure that the country settings of the wireless network are correct.

France

- For 2.4-GHz Wireless LAN operation of this product, certain restrictions apply: This product may be used indoors for the entire 2400-MHz to 2483.5-MHz frequency band (channels 1 to 13). For outdoor use, only the 2400-MHz to 2454-MHz frequency band (channels 1 to 7) may be used. For the latest requirements, see www.arcep.fr.

The point of contact for regulatory matters is:

Hewlett-Packard GmbH, Dept./MS: HQ-TRE, Herrenberger Strasse 140, 71034 Boeblingen, GERMANY

Regulatory telecommunication notices

The HP Photosmart meets telecommunication requirements from regulatory agencies in your country/region.

This section contains the following topics:

- [Notice to users of the U.S. telephone network: FCC requirements](#)
- [Notice to users of the Canadian telephone network](#)
- [Notice to users of the German telephone network](#)
- [Australia wired fax statement](#)

Notice to users of the U.S. telephone network: FCC requirements

Notice to users of the U.S. telephone network: FCC requirements

This equipment complies with FCC rules, Part 68. On this equipment is a label that contains, among other information, the FCC Registration Number and Ringer Equivalent Number (REN) for this equipment. If requested, provide this information to your telephone company.

An FCC compliant telephone cord and modular plug is provided with this equipment. This equipment is designed to be connected to the telephone network or premises wiring using a compatible modular jack which is Part 68 compliant. This equipment connects to the telephone network through the following standard network interface jack: USOC RJ-11C.

The REN is useful to determine the quantity of devices you may connect to your telephone line and still have all of those devices ring when your number is called. Too many devices on one line might result in failure to ring in response to an incoming call. In most, but not all, areas the sum of the RENs of all devices should not exceed five (5). To be certain of the number of devices you may connect to your line, as determined by the REN, you should call your local telephone company to determine the maximum REN for your calling area.

If this equipment causes harm to the telephone network, your telephone company might discontinue your service temporarily. If possible, they will notify you in advance. If advance notice is not practical, you will be notified as soon as possible. You will also be advised of your right to file a complaint with the FCC. Your telephone company might make changes in its facilities, equipment, operations, or procedures that could affect the proper operation of your equipment. If they do, you will be given advance notice so you will have the opportunity to maintain uninterrupted service. If you experience trouble with this equipment, please contact the manufacturer, or look elsewhere in this manual, for warranty or repair information. Your telephone company might ask you to disconnect this equipment from the network until the problem has been corrected or until you are sure that the equipment is not malfunctioning.

This equipment may not be used on coin service provided by the telephone company.

Connection to party lines is subject to state tariffs. Contact your state public utility commission, public service commission, or corporation commission for more information.

This equipment includes automatic dialing capability. When programming and/or making test calls to emergency numbers:

- Remain on the line and explain to the dispatcher the reason for the call.
- Perform such activities in the off-peak hours, such as early morning or late evening.



Note The FCC hearing aid compatibility rules for telephones are not applicable to this equipment.

The Telephone Consumer Protection Act of 1991 makes it unlawful for any person to use a computer or other electronic device, including fax machines, to send any message unless such message clearly contains in a margin at the top or bottom of each transmitted page or on the first page of transmission, the date and time it is sent and an identification of the business, other entity, or other individual sending the message and the telephone number of the sending machine or such business, other entity, or individual. (The telephone number provided might not be a 900 number or any other number for which charges exceed local or long-distance transmission charges.) In order to program this information into your fax machine, you should complete the steps described in the software.

Notice to users of the Canadian telephone network

Note à l'attention des utilisateurs du réseau téléphonique canadien/Notice to users of the Canadian telephone network

Cet appareil est conforme aux spécifications techniques des équipements terminaux d'Industrie Canada. Le numéro d'enregistrement atteste de la conformité de l'appareil. L'abréviation IC qui précède le numéro d'enregistrement indique que l'enregistrement a été effectué dans le cadre d'une Déclaration de conformité stipulant que les spécifications techniques d'Industrie Canada ont été respectées. Néanmoins, cette abréviation ne signifie en aucun cas que l'appareil a été validé par Industrie Canada.

Pour leur propre sécurité, les utilisateurs doivent s'assurer que les prises électriques reliées à la terre de la source d'alimentation, des lignes téléphoniques et du circuit métallique d'alimentation en eau sont, le cas échéant, branchées les unes aux autres. Cette précaution est particulièrement importante dans les zones rurales.



Remarque Le numéro REN (Ringer Equivalence Number) attribué à chaque appareil terminal fournit une indication sur le nombre maximal de terminaux qui peuvent être connectés à une interface téléphonique. La terminaison d'une interface peut se composer de n'importe quelle combinaison d'appareils, à condition que le total des numéros REN ne dépasse pas 5.

Basé sur les résultats de tests FCC Partie 68, le numéro REN de ce produit est 0.0B.

This equipment meets the applicable Industry Canada Terminal Equipment Technical Specifications. This is confirmed by the registration number. The abbreviation IC before the registration number signifies that registration was performed based on a Declaration of Conformity indicating that Industry Canada technical specifications were met. It does not imply that Industry Canada approved the equipment.

Users should ensure for their own protection that the electrical ground connections of the power utility, telephone lines and internal metallic water pipe system, if present, are connected together. This precaution might be particularly important in rural areas.



Note The REN (Ringer Equivalence Number) assigned to each terminal device provides an indication of the maximum number of terminals allowed to be connected to a telephone interface. The termination on an interface might consist of any combination of devices subject only to the requirement that the sum of the Ringer Equivalence Numbers of all the devices does not exceed 5.

The REN for this product is 0.0B, based on FCC Part 68 test results.

Notice to users of the German telephone network

Hinweis für Benutzer des deutschen Telefonnetzes

Dieses HP-Fax ist nur für den Anschluss eines analogen Public Switched Telephone Network (PSTN) gedacht. Schließen Sie den TAE N-Telefonstecker, der im Lieferumfang des HP All-in-One enthalten ist, an die Wandsteckdose (TAE 6) Code N an. Dieses HP-Fax kann als einzelnes Gerät und/oder in Verbindung (mit seriellen Anschluss) mit anderen zugelassenen Endgeräten verwendet werden.

Australia wired fax statement

In Australia, the HP device must be connected to Telecommunication Network through a line cord which meets the requirements of the Technical Standard AS/ACIF S008.

Regulatory wireless statements

This section contains the following regulatory information pertaining to wireless products:

- [Exposure to radio frequency radiation](#)
- [Notice to users in Brazil](#)

- [Notice to users in Canada](#)
- [Notice to users in Mexico](#)
- [Notice to users in Taiwan](#)

Exposure to radio frequency radiation

Exposure to radio frequency radiation



Caution The radiated output power of this device is far below the FCC radio frequency exposure limits. Nevertheless, the device shall be used in such a manner that the potential for human contact during normal operation is minimized. This product and any attached external antenna, if supported, shall be placed in such a manner to minimize the potential for human contact during normal operation. In order to avoid the possibility of exceeding the FCC radio frequency exposure limits, human proximity to the antenna shall not be less than 20 cm (8 inches) during normal operation.

Notice to users in Brazil

Aviso aos usuários no Brasil

Este equipamento opera em caráter secundário, isto é, não tem direito à proteção contra interferência prejudicial, mesmo de estações do mesmo tipo, e não pode causar interferência a sistemas operando em caráter primário. (Res.ANATEL 282/2001).

Notice to users in Canada

Notice to users in Canada/Note à l'attention des utilisateurs canadiens

Under Industry Canada regulations, this radio transmitter may only operate using an antenna of a type and maximum (or lesser) gain approved for the transmitter by Industry Canada. To reduce potential radio interference to other users, the antenna type and its gain should be so chosen that the equivalent isotropically radiated power (e.i.r.p.) is not more than that necessary for successful communication.

This device complies with Industry Canada licence-exempt RSS standard(s). Operation is subject to the following two conditions: (1) this device may not cause interference, and (2) this device must accept any interference, including interference that may cause undesired operation of the device.

WARNING! Exposure to Radio Frequency Radiation The radiated output power of this device is below the Industry Canada radio frequency exposure limits. Nevertheless, the device should be used in such a manner that the potential for human contact is minimized during normal operation.

To avoid the possibility of exceeding the Industry Canada radio frequency exposure limits, human proximity to the antennas should not be less than 20 cm (8 inches).

Conformément au Règlement d'Industrie Canada, cet émetteur radioélectrique ne peut fonctionner qu'avec une antenne d'un type et d'un gain maximum (ou moindre) approuvé par Industrie Canada. Afin de réduire le brouillage radioélectrique potentiel pour d'autres utilisateurs, le type d'antenne et son gain doivent être choisis de manière à ce que la puissance isotrope rayonnée équivalente (p.i.r.e.) ne dépasse pas celle nécessaire à une communication réussie.

Cet appareil est conforme aux normes RSS exemptes de licence d'Industrie Canada. Son fonctionnement dépend des deux conditions suivantes : (1) cet appareil ne doit pas provoquer d'interférences nuisibles et (2) doit accepter toutes interférences reçues, y compris des interférences pouvant provoquer un fonctionnement non souhaité de l'appareil.

AVERTISSEMENT relatif à l'exposition aux radiofréquences. La puissance de rayonnement de cet appareil se trouve sous les limites d'exposition de radiofréquences d'Industrie Canada. Néanmoins, cet appareil doit être utilisé de telle sorte qu'il soit mis en contact le moins possible avec le corps humain.

Afin d'éviter le dépassement éventuel des limites d'exposition aux radiofréquences d'Industrie Canada, il est recommandé de maintenir une distance de plus de 20 cm entre les antennes et l'utilisateur.

Notice to users in Mexico

Aviso para los usuarios de México

La operación de este equipo está sujeta a las siguientes dos condiciones: (1) es posible que este equipo o dispositivo no cause interferencia perjudicial y (2) este equipo o dispositivo debe aceptar cualquier interferencia, incluyendo la que pueda causar su operación no deseada.

Para saber el modelo de la tarjeta inalámbrica utilizada, revise la etiqueta regulatoria de la impresora.

Notice to users in Taiwan

低功率電波輻射性電機管理辦法

第十二條

經型式認證合格之低功率射頻電機，非經許可，公司、商號或使用者均不得擅自變更頻率、加大功率或變更設計之特性及功能。

第十四條

低功率射頻電機之使用不得影響飛航安全及干擾合法通信；經發現有干擾現象時，應立即停用，並改善至無干擾時方得繼續使用。

前項合法通信，指依電信法規定作業之無線電通信。低功率射頻電機須忍受合法通信或工業、科學及醫藥用電波輻射性電機設備之干擾。

12 Additional fax setup

After completing all the steps in the getting started guide, use the instructions in this section to complete your fax setup. Keep your getting started guide for later use.

In this section, you learn how to set up the printer so that faxing works successfully with equipment and services you might already have on the same phone line.

 **TIP:** You can also use the Fax Setup Wizard (Windows) or HP Setup Assistant (Mac OS X) to help you quickly set up some important fax settings such as the answer mode and fax header information. You can access these tools through the HP software you installed with the printer. After you run these tools, follow the procedures in this section to complete your fax setup.

This section contains the following topics:

- [Set up faxing \(parallel phone systems\)](#)
- [Serial-type fax setup](#)
- [Test fax setup](#)

Set up faxing (parallel phone systems)

Before you begin setting up the printer for faxing, determine which kind of phone system your country/region uses. The instructions for fax setup differ depending on whether you have a serial- or parallel-type phone system.

- If you do not see your country/region listed in the table, you probably have a serial-type phone system. In a serial-type phone system, the connector type on your shared telephone equipment (modems, phones, and answering machines) does not allow a physical connection to the "2-EXT" port on the printer. Instead, all equipment must be connected at the telephone wall jack.

 **NOTE:** In some countries/regions that use serial-type phone systems, the phone cord that came with the printer might have an additional wall plug attached to it. This enables you to connect other telecom devices to the wall jack where you plug in the printer.

You might need to connect the supplied phone cord to the adapter provided for your country/region.

- If your country/region is listed in the table, you probably have a parallel-type telephone system. In a parallel-type phone system, you are able to connect shared telephone equipment to the phone line by using the "2-EXT" port on the back of the printer.

 **NOTE:** If you have a parallel-type phone system, HP recommends you use the 2-wire phone cord supplied with the printer to connect it to the telephone wall jack.

Countries/regions with a parallel-type phone system

| | | |
|-----------|---------------|--------------|
| Argentina | Australia | Brazil |
| Canada | Chile | China |
| Colombia | Greece | India |
| Indonesia | Ireland | Japan |
| Korea | Latin America | Malaysia |
| Mexico | Philippines | Poland |
| Portugal | Russia | Saudi Arabia |
| Singapore | Spain | Taiwan |
| Thailand | USA | Venezuela |
| Vietnam | | |

If you are unsure which kind of telephone system you have (serial or parallel), check with your telephone company.

This section contains the following topics:

- [Select the correct fax setup for your home or office](#)
- [Case A: Separate fax line \(no voice calls received\)](#)
- [Case B: Set up the printer with DSL](#)
- [Case C: Set up the printer with a PBX phone system or an ISDN line](#)
- [Case D: Fax with a distinctive ring service on the same line](#)
- [Case E: Shared voice/fax line](#)
- [Case F: Shared voice/fax line with voice mail](#)
- [Case G: Fax line shared with computer modem \(no voice calls received\)](#)
- [Case H: Shared voice/fax line with computer modem](#)
- [Case I: Shared voice/fax line with answering machine](#)
- [Case J: Shared voice/fax line with computer modem and answering machine](#)
- [Case K: Shared voice/fax line with computer dial-up modem and voice mail](#)

Select the correct fax setup for your home or office

To fax successfully, you need to know what types of equipment and services (if any) share the same phone line with the printer. This is important because you might need to connect some of your existing office equipment directly to the printer, and you might also need to change some fax settings before you can fax successfully.

1. Determine if your telephone system is serial or parallel. See [Set up faxing \(parallel phone systems\)](#).
 - a. Serial-type telephone system—See [Serial-type fax setup](#).
 - b. Parallel-type telephone system—Go to step 2.
2. Select the combination of equipment and services sharing your fax line.
 - DSL: A Digital subscriber line (DSL) service through your telephone company. (DSL might be called ADSL in your country/region.)
 - PBX: A private branch exchange (PBX) phone system or an integrated services digital network (ISDN) system.
 - Distinctive ring service: A distinctive ring service through your telephone company provides multiple telephone numbers with different ring patterns.
 - Voice calls: Voice calls are received at the same phone number you use for fax calls on the printer.
 - Computer dial-up modem: A computer dial-up modem is on the same phone line as the printer. If you answer Yes to any of the following questions, you are using a computer dial-up modem:
 - Do you send and receive faxes directly to and from your computer software applications through a dial-up connection?
 - Do you send and receive email messages on your computer through a dial-up connection?
 - Do you access the Internet from your computer through a dial-up connection?
 - Answering machine: An answering machine that answers voice calls at the same phone number you use for fax calls on the printer.
 - Voice mail service: A voice mail subscription through your telephone company at the same number you use for fax calls on the printer.
3. From the following table, select the combination of equipment and services applicable to your home or office setting. Then look up the recommended fax setup. Step-by-step instructions are included for each case in the sections that follow.

 **NOTE:** If your home or office setup is not described in this section, set up the printer as you would a regular analog phone. Make sure you use the phone cord supplied in the box to connect one end to your telephone wall jack and the other end to the port labeled 1-LINE on the back of the printer. If you use another phone cord, you might experience problems sending and receiving faxes.

You might need to connect the supplied phone cord to the adapter provided for your country/region.

| Other equipment or services sharing your fax line | | | | | | | Recommended fax setup |
|---|-----|--------------------------|-------------|------------------------|-------------------|--------------------|--|
| DSL | PBX | Distinctive ring service | Voice calls | Computer dial-up modem | Answering machine | Voice mail service | |
| | | | | | | | Case A: Separate fax line (no voice calls received) |
| ✓ | | | | | | | Case B: Set up the printer with DSL |
| | ✓ | | | | | | Case C: Set up the printer with a PBX phone system or an ISDN line |
| | | ✓ | | | | | Case D: Fax with a distinctive ring service on the same line |
| | | | ✓ | | | | Case E: Shared voice/fax line |
| | | | ✓ | | | ✓ | Case F: Shared voice/fax line with voice mail |
| | | | | ✓ | | | Case G: Fax line shared with computer modem (no voice calls received) |
| | | | ✓ | ✓ | | | Case H: Shared voice/fax line with computer modem |
| | | | ✓ | | ✓ | | Case I: Shared voice/fax line with answering machine |
| | | | ✓ | ✓ | ✓ | | Case J: Shared voice/fax line with computer modem and answering machine |
| | | | ✓ | ✓ | | ✓ | Case K: Shared voice/fax line with computer dial-up modem and voice mail |

Case A: Separate fax line (no voice calls received)

If you have a separate phone line on which you receive no voice calls, and you have no other equipment connected on this phone line, set up the printer as described in this section.

Back view of the printer

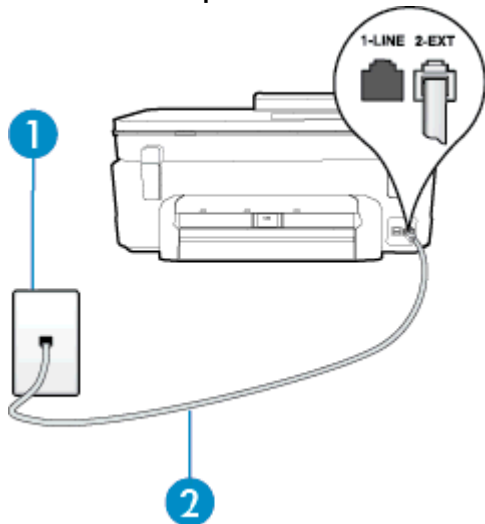

| | |
|---|---|
| 1 | Telephone wall jack |
| 2 | Use the phone cord supplied in the box with the printer to connect to the 1-LINE port. You might need to connect the supplied phone cord to the adapter provided for your country/region. |

To set up the printer with a separate fax line

- Using the phone cord supplied in the box with the printer, connect one end to your telephone wall jack, then connect the other end to the port labeled 1-LINE on the back of the printer.

 **NOTE:** You might need to connect the supplied phone cord to the adapter provided for your country/region.

If you do not use the supplied cord to connect from the telephone wall jack to the printer, you might not be able to fax successfully. This special phone cord is different from the phone cords you might already have in your home or office.

- Turn on the **Auto Answer** setting.
- (Optional) Change the **Rings to Answer** setting to the lowest setting (two rings).
- Run a fax test.

When the phone rings, the printer answers automatically after the number of rings you set in the **Rings to Answer** setting. The printer begins emitting fax reception tones to the sending fax machine and receives the fax.

Case B: Set up the printer with DSL

If you have a DSL service through your telephone company, and do not connect any equipment to the printer, use the instructions in this section to connect a DSL filter between the telephone wall jack and the printer. The DSL filter removes the digital signal that can interfere with the printer, so the printer can communicate correctly with the phone line. (DSL might be called ADSL in your country/region.)

 **NOTE:** If you have a DSL line and you do not connect the DSL filter, you cannot send and receive faxes with the printer.

Back view of the printer

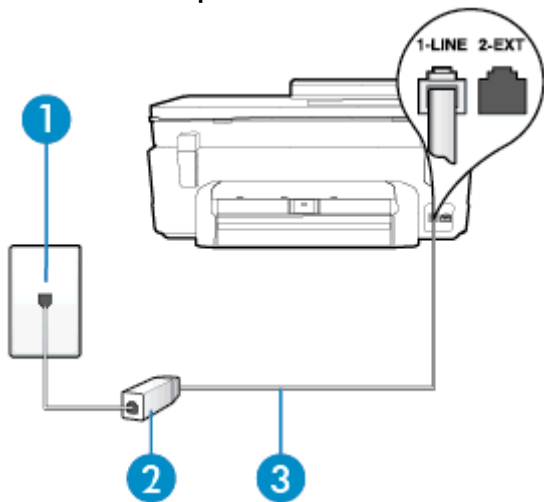

| | |
|---|---|
| 1 | Telephone wall jack |
| 2 | DSL (or ADSL) filter and cord supplied by your DSL provider |
| 3 | Use the phone cord supplied in the box with the printer to connect to the 1-LINE port. You might need to connect the supplied phone cord to the adapter provided for your country/region. |

To set up the printer with DSL

1. Obtain a DSL filter from your DSL provider.
2. Using the phone cord supplied in the box with the printer, connect one end to the open port on the DSL filter, and then connect the other end to the port labeled 1-LINE on the back of the printer.

 **NOTE:** You might need to connect the supplied phone cord to the adapter provided for your country/region.

If you do not use the supplied cord to connect from the DSL filter to the printer, you might not be able to fax successfully. This special phone cord is different from the phone cords you might already have in your home or office.

As only one phone cord is supplied, you might need to obtain additional phone cords for this setup.

3. Connect an additional phone cord from the DSL filter to the telephone wall jack.
4. Run a fax test.

If you encounter problems setting up the printer with optional equipment, contact your local service provider or vendor for further assistance.

Case C: Set up the printer with a PBX phone system or an ISDN line

If you are using either a PBX phone system or an ISDN converter/terminal adapter, make sure you do the following:

- If you are using either a PBX or an ISDN converter/terminal adapter, connect the printer to the port that is designated for fax and phone use. Also, make sure that the terminal adapter is set to the correct switch type for your country/region, if possible.

 **NOTE:** Some ISDN systems allow you to configure the ports for specific phone equipment. For example, you might have assigned one port for telephone and Group 3 fax and another port for multiple purposes. If you have problems when connected to the fax/phone port of your ISDN converter, try using the port designated for multiple purposes; it might be labeled "multi-combi" or something similar.

- If you are using a PBX phone system, set the call waiting tone to "off."

 **NOTE:** Many digital PBX systems include a call-waiting tone that is set to "on" by default. The call waiting tone interferes with any fax transmission, and you cannot send or receive faxes with the printer. Refer to the documentation that came with your PBX phone system for instructions on how to turn off the call-waiting tone.

- If you are using a PBX phone system, dial the number for an outside line before dialing the fax number.
- Make sure you use the supplied cord to connect from the telephone wall jack to the printer. If you do not, you might not be able to fax successfully. This special phone cord is different from the phone cords you might already have in your home or office. If the supplied phone cord is too short, you can purchase a coupler from your local electronics store and extend it.

You might need to connect the supplied phone cord to the adapter provided for your country/region.

If you encounter problems setting up the printer with optional equipment, contact your local service provider or vendor for further assistance.

Case D: Fax with a distinctive ring service on the same line

If you subscribe to a distinctive ring service (through your telephone company) that allows you to have multiple phone numbers on one phone line, each with a different ring pattern, set up the printer as described in this section.

Back view of the printer

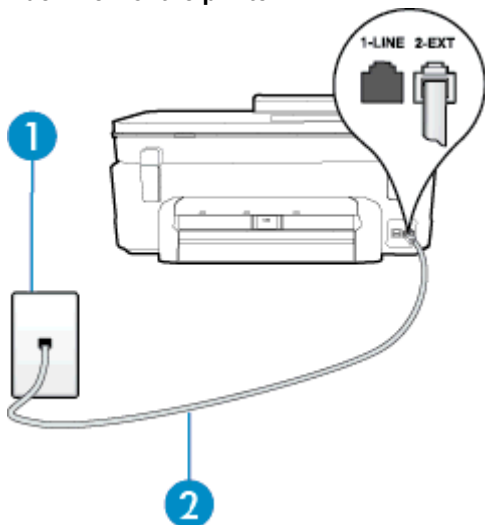

| | |
|---|---|
| 1 | Telephone wall jack |
| 2 | Use the phone cord supplied in the box with the printer to connect to the 1-LINE port. You might need to connect the supplied phone cord to the adapter provided for your country/region. |

To set up the printer with a distinctive ring service

- Using the phone cord supplied in the box with the printer, connect one end to your telephone wall jack, then connect the other end to the port labeled 1-LINE on the back of the printer.

 **NOTE:** You might need to connect the supplied phone cord to the adapter provided for your country/region.

If you do not use the supplied cord to connect from the telephone wall jack to the printer, you might not be able to fax successfully. This special phone cord is different from the phone cords you might already have in your home or office.

- Turn on the **Auto Answer** setting.
- Change the **Distinctive Ring** setting to match the pattern that the telephone company assigned to your fax number.

 **NOTE:** By default, the printer is set to answer all ring patterns. If you do not set the **Distinctive Ring** to match the ring pattern assigned to your fax number, the printer might answer both voice calls and fax calls or it might not answer at all.

 **TIP:** You can also use the Ring Pattern Detection feature in the printer's control panel to set distinctive ring. With this feature, the printer recognizes and records the ring pattern of an incoming call and, based on this call, automatically determines the distinctive ring pattern assigned by your telephone company to fax calls. For more information, see [Change the answer ring pattern for distinctive ring](#).

- (Optional) Change the **Rings to Answer** setting to the lowest setting (two rings).
- Run a fax test.

The printer automatically answers incoming calls that have the ring pattern you selected (**Distinctive Ring** setting) after the number of rings you selected (**Rings to Answer** setting). The printer begins emitting fax reception tones to the sending fax machine and receives the fax.

If you encounter problems setting up the printer with optional equipment, contact your local service provider or vendor for further assistance.

Case E: Shared voice/fax line

If you receive both voice calls and fax calls at the same phone number, and you have no other office equipment (or voice mail) on this phone line, set up the printer as described in this section.

Back view of the printer

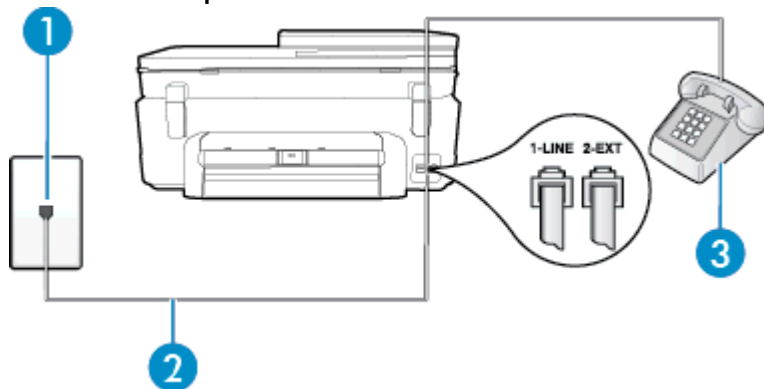

| | |
|---|---|
| 1 | Telephone wall jack |
| 2 | Use the phone cord supplied in the box with the printer to connect to the 1-LINE port. You might need to connect the supplied phone cord to the adapter provided for your country/region. |
| 3 | Telephone (optional) |

To set up the printer with a shared voice/fax line

- Using the phone cord supplied in the box with the printer, connect one end to your telephone wall jack, then connect the other end to the port labeled 1-LINE on the back of the printer.

NOTE: You might need to connect the supplied phone cord to the adapter provided for your country/region.

If you do not use the supplied cord to connect from the telephone wall jack to the printer, you might not be able to fax successfully. This special phone cord is different from the phone cords you might already have in your home or office.

- Do one of the following:
 - If you have a parallel-type phone system, remove the white plug from the port labeled 2-EXT on the back of the printer, and then connect a phone to this port.
 - If you have a serial-type phone system, you might plug your phone directly on top of the printer cable which has a wall plug attached to it.
- Now you need to decide how you want the printer to answer calls, automatically or manually:
 - If you set up the printer to answer calls **automatically**, it answers all incoming calls and receives faxes. The printer cannot distinguish between fax and voice calls in this case; if you suspect the call is a voice call, you need to answer it before the printer answers the call. To set up the printer to answer calls automatically, turn on the **Auto Answer** setting.
 - If you set up the printer to answer faxes **manually**, you must be available to respond in person to incoming fax calls or the printer cannot receive faxes. To set up the printer to answer calls manually, turn off the **Auto Answer** setting.
- Run a fax test.

If you pick up the phone before the printer answers the call and hear fax tones from a sending fax machine, you need to answer the fax call manually.

If you encounter problems setting up the printer with optional equipment, contact your local service provider or vendor for further assistance.

Case F: Shared voice/fax line with voice mail

If you receive both voice calls and fax calls at the same phone number, and you also subscribe to a voice mail service through your telephone company, set up the printer as described in this section.

 **NOTE:** You cannot receive faxes automatically if you have a voice mail service at the same phone number you use for fax calls. You must receive faxes manually; this means you must be available to respond in person to incoming fax calls. If you want to receive faxes automatically instead, contact your telephone company to subscribe to a distinctive ring service, or to obtain a separate phone line for faxing.

Back view of the printer

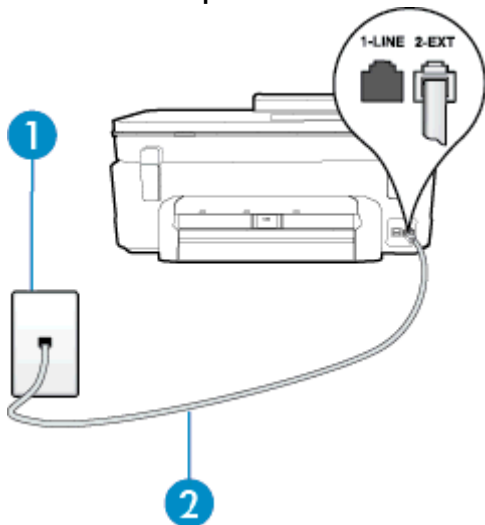

| | |
|---|---|
| 1 | Telephone wall jack |
| 2 | Use the phone cord supplied in the box with the printer to connect to the 1-LINE port. You might need to connect the supplied phone cord to the adapter provided for your country/region. |

To set up the printer with voice mail

- Using the phone cord supplied in the box with the printer, connect one end to your telephone wall jack, then connect the other end to the port labeled 1-LINE on the back of the printer. You might need to connect the supplied phone cord to the adapter provided for your country/region.

 **NOTE:** You might need to connect the supplied phone cord to the adapter provided for your country/region.

If you do not use the supplied cord to connect from the telephone wall jack to the printer, you might not be able to fax successfully. This special phone cord is different from the phone cords you might already have in your home or office.

- Turn off the **Auto Answer** setting.
- Run a fax test.

You must be available to respond in person to incoming fax calls, or the printer cannot receive faxes. You must initiate the manual fax before voicemail picks up the line.

If you encounter problems setting up the printer with optional equipment, contact your local service provider or vendor for further assistance.

Case G: Fax line shared with computer modem (no voice calls received)

If you have a fax line on which you receive no voice calls, and you also have a computer modem connected on this line, set up the printer as described in this section.

 **NOTE:** If you have a computer dial-up modem, your computer dial-up modem shares the phone line with the printer. You cannot use both your modem and the printer simultaneously. For example, you cannot use the printer for faxing while you are using your computer dial-up modem to send an email or access the Internet.

- [Set up the printer with a computer dial-up modem](#)
- [Set up the printer with a computer DSL/ADSL modem](#)

Set up the printer with a computer dial-up modem

If you are using the same phone line for sending faxes and for a computer dial-up modem, follow these directions for setting up the printer.

Back view of the printer

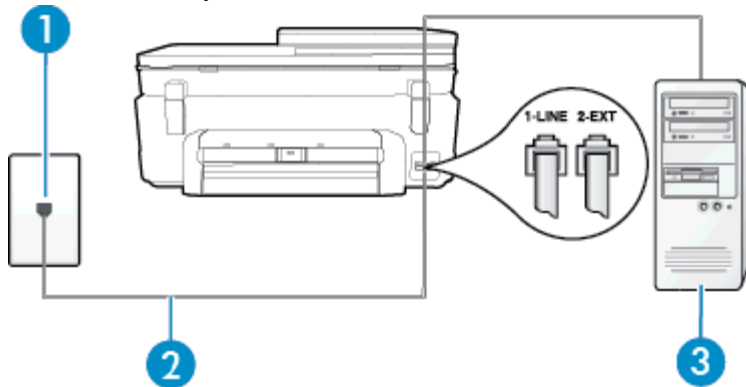

| | |
|---|---|
| 1 | Telephone wall jack |
| 2 | Use the phone cord supplied in the box with the printer to connect to the 1-LINE port. You might need to connect the supplied phone cord to the adapter provided for your country/region. |
| 3 | Computer with modem |

To set up the printer with a computer dial-up modem

1. Remove the white plug from the port labeled 2-EXT on the back of the printer.
2. Find the phone cord that connects from the back of your computer (your computer dial-up modem) to a telephone wall jack. Disconnect the cord from the telephone wall jack and plug it into the port labeled 2-EXT on the back of the printer.
3. Using the phone cord supplied in the box with the printer, connect one end to your telephone wall jack, then connect the other end to the port labeled 1-LINE on the back of the printer.

 **NOTE:** You might need to connect the supplied phone cord to the adapter provided for your country/region.

If you do not use the supplied cord to connect from the telephone wall jack to the printer, you might not be able to fax successfully. This special phone cord is different from the phone cords you might already have in your home or office.

4. If your modem software is set to receive faxes to your computer automatically, turn off that setting.

 **NOTE:** If you do not turn off the automatic fax reception setting in your modem software, the printer cannot receive faxes.

5. Turn on the **Auto Answer** setting.

6. (Optional) Change the **Rings to Answer** setting to the lowest setting (two rings).
7. Run a fax test.

When the phone rings, the printer automatically answers after the number of rings you set in the **Rings to Answer** setting. The printer begins emitting fax reception tones to the sending fax machine and receives the fax.

If you encounter problems setting up the printer with optional equipment, contact your local service provider or vendor for further assistance.

Set up the printer with a computer DSL/ADSL modem

If you have a DSL line and use that phone line to send faxes, follow these instructions to set up your fax.

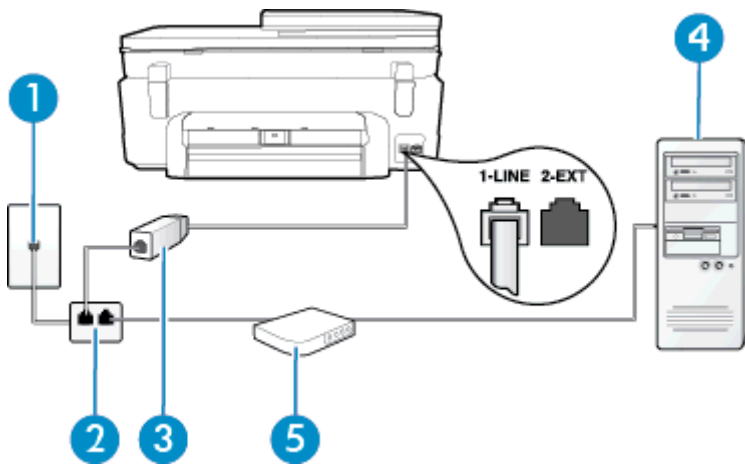

| | |
|---|---|
| 1 | Telephone wall jack |
| 2 | Parallel splitter |
| 3 | DSL/ADSL filter Connect one end of the phone jack that was supplied with the printer to connect to the 1-LINE port on the back of the printer. Connect the other end of the cord to the DSL/ADSL filter. You might need to connect the supplied phone cord to the adapter provided for your country/region. |
| 4 | Computer |
| 5 | Computer DSL/ADSL modem |

NOTE: You need to purchase a parallel splitter. A parallel splitter has one RJ-11 port on the front and two RJ-11 ports on the back. Do not use a 2-line phone splitter, a serial splitter, or a parallel splitter which has two RJ-11 ports on the front and a plug on the back.



To set up the printer with a computer DSL/ADSL modem

1. Obtain a DSL filter from your DSL provider.
2. Using the phone cord provided in the box with the printer, connect one end to the DSL filter, and then connect the other end to the port labeled 1-LINE on the back of the printer.

 **NOTE:** You might need to connect the supplied phone cord to the adapter provided for your country/region.

If you do not use the supplied cord to connect from the DSL filter to the back of the printer, you might not be able to fax successfully. This special phone cord is different from the phone cords you might already have in your home or office.

3. Connect the DSL filter to the parallel splitter.
4. Connect the DSL modem to the parallel splitter.
5. Connect the parallel splitter to the wall jack.
6. Run a fax test.

When the phone rings, the printer automatically answers after the number of rings you set in the **Rings to Answer** setting. The printer begins emitting fax reception tones to the sending fax machine and receives the fax.

If you encounter problems setting up the printer with optional equipment, contact your local service provider or vendor for further assistance.

Case H: Shared voice/fax line with computer modem

There are two different ways to set up the printer with your computer based on the number of phone ports on your computer. Before you begin, check your computer to see if it has one or two phone ports.

 **NOTE:** If your computer has only one phone port, you need to purchase a parallel splitter (also called a coupler), as shown in the illustration. (A parallel splitter has one RJ-11 port on the front and two RJ-11 ports on the back. Do not use a two-line phone splitter, a serial splitter, or a parallel splitter which has two RJ-11 ports on the front and a plug on the back.)

- [Shared voice/fax with computer dial-up modem](#)
- [Shared voice/fax with computer DSL/ADSL modem](#)

Shared voice/fax with computer dial-up modem

If you use your phone line for both fax and telephone calls, use these instructions to set up your fax.

There are two different ways to set up the printer with your computer based on the number of phone ports on your computer. Before you begin, check your computer to see if it has one or two phone ports.

 **NOTE:** If your computer has only one phone port, you need to purchase a parallel splitter (also called a coupler), as shown in the illustration. (A parallel splitter has one RJ-11 port on the front and two RJ-11 ports on the back. Do not use a two-line phone splitter, a serial splitter, or a parallel splitter which has two RJ-11 ports on the front and a plug on the back.)

Example of a parallel splitter



To set up the printer on the same phone line as a computer with two phone ports

Back view of the printer

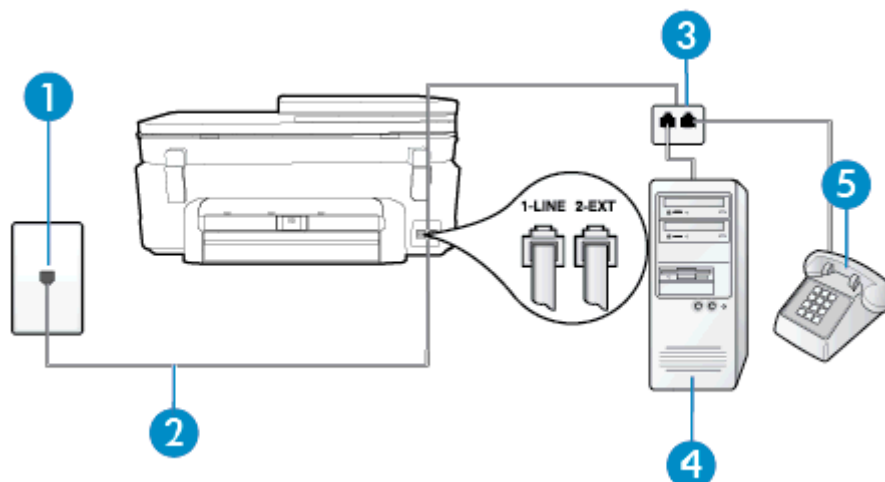

| | |
|---|--|
| 1 | Telephone wall jack |
| 2 | Use the phone cord supplied in the box with the printer to connect to the 1-LINE port. |
| 3 | Parallel splitter |
| 4 | Computer with modem |
| 5 | Telephone |

1. Remove the white plug from the port labeled 2-EXT on the back of the printer.
2. Find the phone cord that connects from the back of your computer (your computer dial-up modem) to a telephone wall jack. Disconnect the cord from the telephone wall jack and plug it into the port labeled 2-EXT on the back of the printer.
3. Connect a phone to the "OUT" port on the back of your computer dial-up modem.
4. Using the phone cord supplied in the box with the printer, connect one end to your telephone wall jack, then connect the other end to the port labeled 1-LINE on the back of the printer.

 **NOTE:** You might need to connect the supplied phone cord to the adapter provided for your country/region.

If you do not use the supplied cord to connect from the telephone wall jack to the printer, you might not be able to fax successfully. This special phone cord is different from the phone cords you might already have in your home or office.

5. If your modem software is set to receive faxes to your computer automatically, turn off that setting.

 **NOTE:** If you do not turn off the automatic fax reception setting in your modem software, the printer cannot receive faxes.

6. Now you need to decide how you want the printer to answer calls, automatically or manually:
 - If you set up the printer to answer calls **automatically**, it answers all incoming calls and receives faxes. The printer cannot distinguish between fax and voice calls in this case; if you suspect the call is a voice call, you need to answer it before the printer answers the call. To set up the printer to answer calls automatically, turn on the **Auto Answer** setting.
 - If you set up the printer to answer faxes **manually**, you must be available to respond in person to incoming fax calls or the printer cannot receive faxes. To set up the printer to answer calls manually, turn off the **Auto Answer** setting.
7. Run a fax test.

If you pick up the phone before the printer answers the call and hear fax tones from a sending fax machine, you need to answer the fax call manually.

If you use your phone line for voice, fax, and your computer dial-up modem, follow these directions to set up your fax.

If you encounter problems setting up the printer with optional equipment, contact your local service provider or vendor for further assistance.

Shared voice/fax with computer DSL/ADSL modem

Use these instructions if your computer has a DSL/ADSL modem

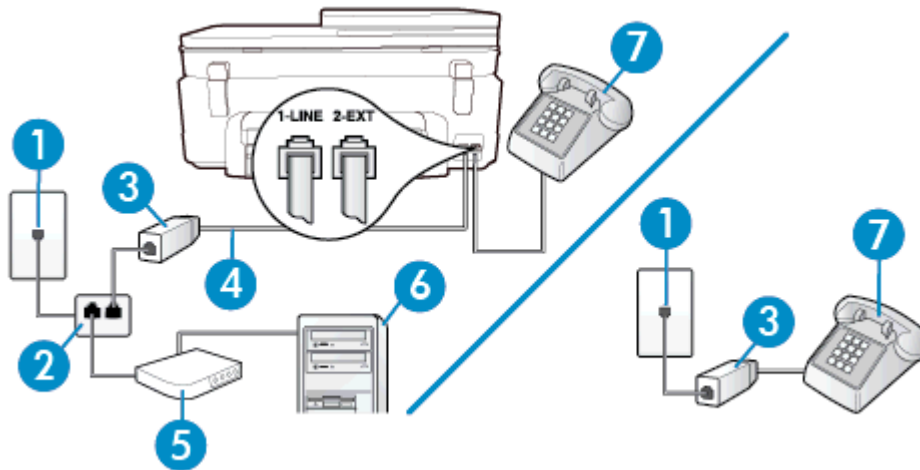

| | |
|---|---|
| 1 | Telephone wall jack |
| 2 | Parallel splitter |
| 3 | DSL/ADSL filter |
| 4 | Use the phone cord provided to connect to the 1-LINE port on the back of the printer. You might need to connect the supplied phone cord to the adapter provided for your country/ region. |
| 5 | DSL/ADSL modem |
| 6 | Computer |
| 7 | Telephone |

NOTE: You need to purchase a parallel splitter. A parallel splitter has one RJ-11 port on the front and two RJ-11 ports on the back. Do not use a 2-line phone splitter, a serial splitter, or a parallel splitter which has two RJ-11 ports on the front and a plug on the back.



To set up the printer with a computer DSL/ADSL modem

1. Obtain a DSL filter from your DSL provider.

 **NOTE:** Phones in other parts of the home/office sharing the same phone number with DSL service need to be connected to additional DSL filters to avoid noise when making voice calls.

2. Using the phone cord supplied in the box with the printers, connect one end to the DSL filter, then connect the other end to the port labeled 1-LINE on the back of the printer.

 **NOTE:** You might need to connect the supplied phone cord to the adapter provided for your country/region.

If you do not use the supplied cord to connect from the DSL filter to the printer, you might not be able to fax successfully. This special phone cord is different from phone cords you might already have in your home or office.

3. If you have a parallel-type phone system, remove the white plug from the port labeled 2-EXT on the back of the printer, and then connect a phone to this port.
4. Connect the DSL filter to the parallel splitter.
5. Connect the DSL modem to the parallel splitter.
6. Connect the parallel splitter to the wall jack.
7. Run a fax test.

When the phone rings, the printer automatically answers after the number of rings you set in the **Rings to Answer** setting. The printer begins emitting fax reception tones to the sending fax machine and receives the fax.

If you encounter problems setting up the printer with optional equipment, contact your local service provider or vendor for further assistance.

Case I: Shared voice/fax line with answering machine

If you receive both voice calls and fax calls at the same phone number, and you also have an answering machine that answers voice calls at this phone number, set up the printer as described in this section.

Back view of the printer

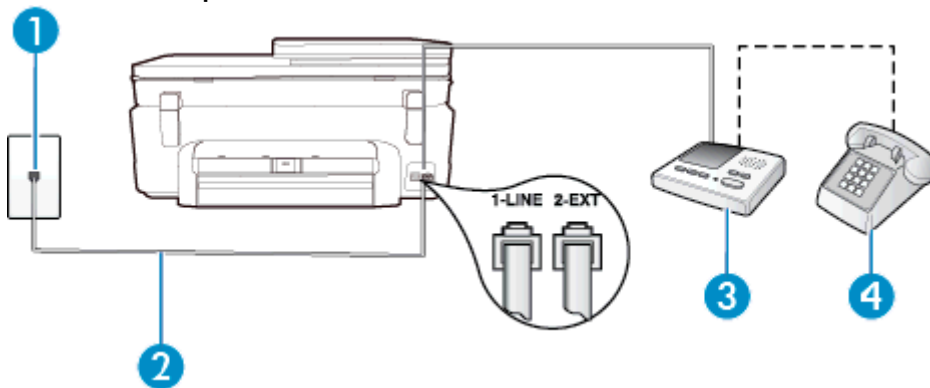

| | |
|---|--|
| 1 | Telephone wall jack |
| 2 | Use the phone cord provided to connect to the 1-LINE port on the back of the printer You might need to connect the supplied phone cord to the adapter provided for your country/region. |
| 3 | Answering machine |
| 4 | Telephone (optional) |

To set up the printer with a shared voice/fax line with answering machine

1. Remove the white plug from the port labeled 2-EXT on the back of the printer.
2. Unplug your answering machine from the telephone wall jack, and connect it to the port labeled 2-EXT on the back of the printer.

 **NOTE:** If you do not connect your answering machine directly to the printer, fax tones from a sending fax machine might be recorded on your answering machine, and you might not receive faxes with the printer.

3. Using the phone cord supplied in the box with the printer, connect one end to your telephone wall jack, then connect the other end to the port labeled 1-LINE on the back of the printer.

 **NOTE:** You might need to connect the supplied phone cord to the adapter provided for your country/region.

If you do not use the supplied cord to connect from the telephone wall jack to the printer, you might not be able to fax successfully. This special phone cord is different from the phone cords you might already have in your home or office.

4. (Optional) If your answering machine does not have a built-in phone, for convenience you might want to connect a phone to the back of your answering machine at the "OUT" port.

 **NOTE:** If your answering machine does not let you connect an external phone, you can purchase and use a parallel splitter (also known as a coupler) to connect both the answering machine and telephone to the printer. You can use standard phone cords for these connections.

5. Turn on the **Auto Answer** setting.
6. Set your answering machine to answer after a low number of rings.
7. Change the **Rings to Answer** setting on the printer to the maximum number of rings supported by your printer. (The maximum number of rings varies by country/region.)
8. Run a fax test.

When the phone rings, your answering machine answers after the number of rings you have set, and then plays your recorded greeting. The printer monitors the call during this time, "listening" for fax tones. If incoming fax tones are detected, the printer emits fax reception tones and receives the fax; if there are no fax tones, the printer stops monitoring the line and your answering machine can record a voice message.

If you encounter problems setting up the printer with optional equipment, contact your local service provider or vendor for further assistance.

Case J: Shared voice/fax line with computer modem and answering machine

If you receive both voice calls and fax calls at the same phone number, and you also have a computer modem and answering machine connected on this phone line, set up the printer as described in this section.

 **NOTE:** Since your computer dial-up modem shares the phone line with the printer, you cannot use both your modem and the printer simultaneously. For example, you cannot use the printer for faxing while you are using your computer dial-up modem to send an email or access the Internet.

- [Shared voice/fax line with computer dial-up modem and answering machine](#)
- [Shared voice/fax line with computer DSL/ADSL modem and answering machine](#)

Shared voice/fax line with computer dial-up modem and answering machine

There are two different ways to set up the printer with your computer based on the number of phone ports on your computer. Before you begin, check your computer to see if it has one or two phone ports.

 **NOTE:** If your computer has only one phone port, you need to purchase a parallel splitter (also called a coupler), as shown in the illustration. (A parallel splitter has one RJ-11 port on the front and two RJ-11 ports on the back. Do not use a two-line phone splitter, a serial splitter, or a parallel splitter which has two RJ-11 ports on the front and a plug on the back.)

Example of a parallel splitter



To set up the printer on the same phone line as a computer with two phone ports

Back view of the printer

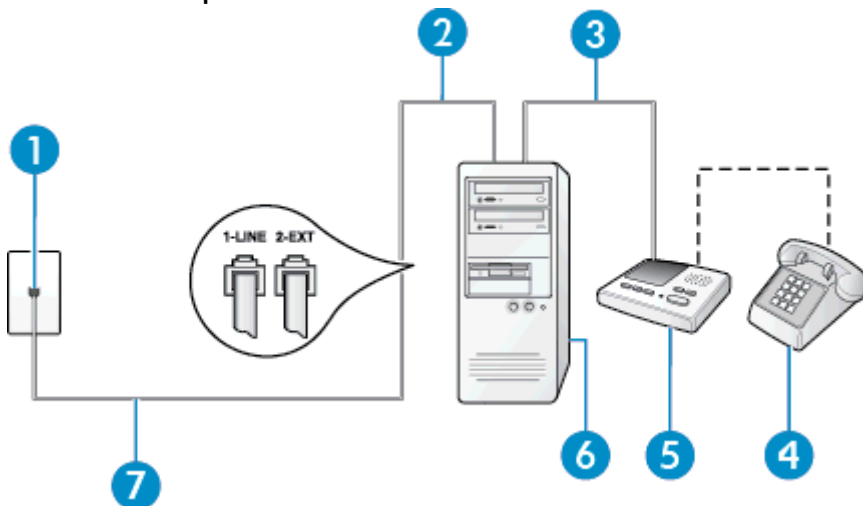

| | |
|---|--|
| 1 | Telephone wall jack |
| 2 | "IN" phone port on your computer |
| 3 | "OUT" phone port on your computer |
| 4 | Telephone (optional) |
| 5 | Answering machine |
| 6 | Computer with modem |
| 7 | Use the phone cord supplied in the box with the printer to connect to the 1-LINE port. You might need to connect the supplied phone cord to the adapter provided for your country/region. |

1. Remove the white plug from the port labeled 2-EXT on the back of the printer.
2. Find the phone cord that connects from the back of your computer (your computer dial-up modem) to a telephone wall jack. Disconnect the cord from the telephone wall jack and plug it into the port labeled 2-EXT on the back of the printer.
3. Unplug your answering machine from the telephone wall jack, and connect it to the port labeled "OUT" on the back of the computer (the computer dial-up modem).
4. Using the phone cord supplied in the box with the printer, connect one end to your telephone wall jack, then connect the other end to the port labeled 1-LINE on the back of the printer.

 **NOTE:** You might need to connect the supplied phone cord to the adapter provided for your country/region.

If you do not use the supplied cord to connect from the telephone wall jack to the printer, you might not be able to fax successfully. This special phone cord is different from the phone cords you might already have in your home or office.

5. (Optional) If your answering machine does not have a built-in phone, for convenience you might want to connect a phone to the back of your answering machine at the "OUT" port.

 **NOTE:** If your answering machine does not let you connect an external phone, you can purchase and use a parallel splitter (also known as a coupler) to connect both the answering machine and telephone to the printer. You can use standard phone cords for these connections.

6. If your modem software is set to receive faxes to your computer automatically, turn off that setting.

 **NOTE:** If you do not turn off the automatic fax reception setting in your modem software, the printer cannot receive faxes.

7. Turn on the **Auto Answer** setting.
8. Set your answering machine to answer after a low number of rings.
9. Change the **Rings to Answer** setting on the printer to the maximum number of rings supported by the product. (The maximum number of rings varies by country/region.)
10. Run a fax test.

When the phone rings, your answering machine answers after the number of rings you have set, and then plays your recorded greeting. The printer monitors the call during this time, "listening" for fax tones. If incoming fax tones are detected, the printer emits fax reception tones and receives the fax; if there are no fax tones, the printer stops monitoring the line and your answering machine can record a voice message.

If you encounter problems setting up the printer with optional equipment, contact your local service provider or vendor for further assistance.

Shared voice/fax line with computer DSL/ADSL modem and answering machine

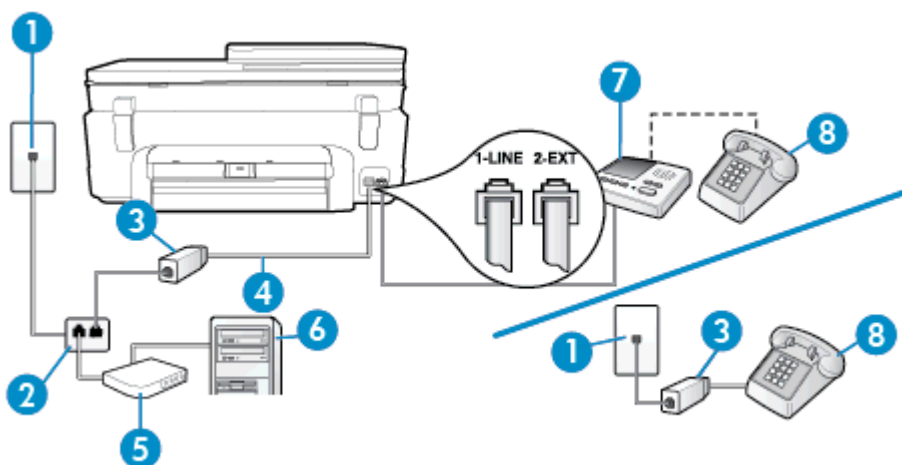

| | |
|---|--|
| 1 | Telephone wall jack |
| 2 | Parallel splitter |
| 3 | DSL/ADSL filter |
| 4 | Phone cord provided with the printer connected to the 1-LINE port on the back of the printer You might need to connect the supplied phone cord to the adapter provided for your country/region. |
| 5 | DSL/ADSL modem |
| 6 | Computer |
| 7 | Answering machine |
| 8 | Telephone (optional) |

 **NOTE:** You need to purchase a parallel splitter. A parallel splitter has one RJ-11 port on the front and two RJ-11 ports on the back. Do not use a 2-line phone splitter, a serial splitter, or a parallel splitter which has two RJ-11 ports on the front and a plug on the back.



To set up the printer with a computer DSL/ADSL modem

1. Obtain a DSL/ADSL filter from your DSL/ADSL provider.

 **NOTE:** Phones in other parts of the home/office sharing the same phone number with DSL/ADSL service need to be connected to additional DSL/ADSL filters, to avoid noise when making voice calls.

2. Using the phone cord supplied in the box with the printer, connect one end to the DSL/ADSL filter, then connect the other end to the port labeled 1-LINE on the back of the printer.

 **NOTE:** You might need to connect the supplied phone cord to the adapter provided for your country/region.

If you do not use the supplied cord to connect from the DSL/ADSL filter to the printer, you might not be able to fax successfully. This special phone cord is different from the phone cords you might already have in your home or office.

3. Connect the DSL/ADSL filter to the splitter.
4. Unplug the answering machine from the telephone wall jack, and connect it to the port labeled 2-EXT on the back of the printer.

 **NOTE:** If you do not connect your answering machine directly to the printer, fax tones from a sending fax machine might be recorded on your answering machine, and you might not receive faxes with the printer.

5. Connect the DSL modem to the parallel splitter.
6. Connect the parallel splitter to the wall jack.
7. Set your answering machine to answer after a low number of rings.
8. Change your **Rings to Answer** setting on the printer to the maximum number of rings supported by the printer.

 **NOTE:** The maximum number of rings varies by country/region.

9. Run a fax test.

When the phone rings, your answering machine answers after the number of rings you have set, and then play your recorded greeting. The printer monitors the call during this time, “listening” for fax tones. If incoming fax tones are detected, the printer emits fax reception tones and receive the fax; if there are no fax tones, the printer stops monitoring the line and your answering machine can record a voice message.

If you use the same phone line for telephone, fax, and have a computer DSL modem, follow these instructions to set up your fax.

If you encounter problems setting up the printer with optional equipment, contact your local service provider or vendor for further assistance.

Case K: Shared voice/fax line with computer dial-up modem and voice mail

If you receive both voice calls and fax calls at the same phone number, use a computer dial-up modem on the same phone line, and subscribe to a voice mail service through your telephone company, set up the printer as described in this section.

 **NOTE:** You cannot receive faxes automatically if you have a voice mail service at the same phone number you use for fax calls. You must receive faxes manually; this means you must be available to respond in person to incoming fax calls. If you want to receive faxes automatically instead, contact your telephone company to subscribe to a distinctive ring service, or to obtain a separate phone line for faxing.

Since your computer dial-up modem shares the phone line with the printer, you cannot use both your modem and the printer simultaneously. For example, you cannot use the printer for faxing if you are using your computer dial-up modem to send an email or access the Internet.

There are two different ways to set up the printer with your computer based on the number of phone ports on your computer. Before you begin, check your computer to see if it has one or two phone ports.

- If your computer has only one phone port, you need to purchase a parallel splitter (also called a coupler), as shown in the illustration. (A parallel splitter has one RJ-11 port on the front and two RJ-11 ports on the back. Do not use a two-line phone splitter, a serial splitter, or a parallel splitter which has two RJ-11 ports on the front and a plug on the back.)

Example of a parallel splitter



- If your computer has two phone ports, set up the printer as follows:

Back view of the printer

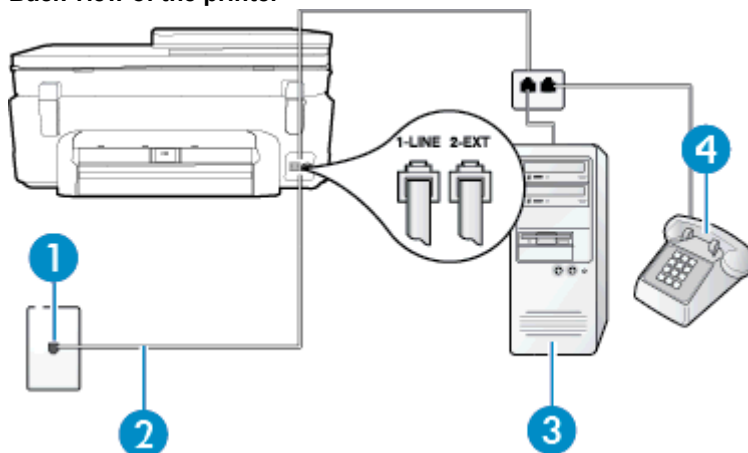

| | |
|---|---|
| 1 | Telephone wall jack |
| 2 | Use the phone cord supplied in the box with the printer to connect to the 1-LINE port. You might need to connect the supplied phone cord to the adapter provided for your country/region. |
| 3 | Computer with modem |
| 4 | Telephone |

To set up the printer on the same phone line as a computer with two phone ports

1. Remove the white plug from the port labeled 2-EXT on the back of the printer.
2. Find the phone cord that connects from the back of your computer (your computer dial-up modem) to a telephone wall jack. Disconnect the cord from the telephone wall jack and plug it into the port labeled 2-EXT on the back of the printer.
3. Connect a phone to the "OUT" port on the back of your computer dial-up modem.

- Using the phone cord supplied in the box with the printer, connect one end to your telephone wall jack, then connect the other end to the port labeled 1-LINE on the back of the printer.

 **NOTE:** You might need to connect the supplied phone cord to the adapter provided for your country/region.

If you do not use the supplied cord to connect from the telephone wall jack to the printer, you might not be able to fax successfully. This special phone cord is different from the phone cords you might already have in your home or office.

- If your modem software is set to receive faxes to your computer automatically, turn off that setting.

 **NOTE:** If you do not turn off the automatic fax reception setting in your modem software, the printer cannot receive faxes.

- Turn off the **Auto Answer** setting.

- Run a fax test.

You must be available to respond in person to incoming fax calls, or the printer cannot receive faxes.

If you encounter problems setting up the printer with optional equipment, contact your local service provider or vendor for further assistance.

Serial-type fax setup

For information on setting up the printer for faxing using a serial-type phone system, see the Fax Configuration web site for your country/region.

| | |
|----------------------|--|
| Austria | www.hp.com/at/faxconfig |
| Germany | www.hp.com/de/faxconfig |
| Switzerland (French) | www.hp.com/ch/fr/faxconfig |
| Switzerland (German) | www.hp.com/ch/de/faxconfig |
| United Kingdom | www.hp.com/uk/faxconfig |
| Finland | www.hp.fi/faxconfig |
| Denmark | www.hp.dk/faxconfig |
| Sweden | www.hp.se/faxconfig |
| Norway | www.hp.no/faxconfig |
| Netherlands | www.hp.nl/faxconfig |
| Belgium (Dutch) | www.hp.be/nl/faxconfig |
| Belgium (French) | www.hp.be/fr/faxconfig |
| Portugal | www.hp.pt/faxconfig |
| Spain | www.hp.es/faxconfig |
| France | www.hp.com/fr/faxconfig |
| Ireland | www.hp.com/ie/faxconfig |
| Italy | www.hp.com/it/faxconfig |

Test fax setup

You can test your fax setup to check the status of the printer and to make sure it is set up correctly for faxing. Perform this test after you have completed setting up the printer for faxing. The test does the following:

- Tests the fax hardware
- Verifies the correct type of phone cord is connected to the printer
- Checks that the phone cord is plugged into the correct port
- Checks for a dial tone
- Checks for an active phone line
- Tests the status of your phone line connection

The printer prints a report with the results of the test. If the test fails, review the report for information on how to fix the problem and rerun the test.

To test fax setup via the printer control panel

1. Set up the printer for faxing according to your particular home or office setup instructions.
2. Make sure the ink cartridges are installed, and that full-size paper is loaded in the input tray before starting the test.
3. From the Home screen, touch **Fax**, and then touch **Settings**.
4. Touch **Tools**, and then touch **Run Fax Test**.
The printer displays the status of the test on the display and prints a report.
5. Review the report.
 - If the test passes and you are still having problems faxing, check the fax settings listed in the report to verify the settings are correct. A blank or incorrect fax setting can cause problems faxing.
 - If the test fails, review the report for more information on how to fix any problems found.

Index

Symbols/Numerics

10 x 15 cm photo paper specifications 62

A

ADSL, fax setup with
parallel phone systems 80
after the support period 56
answer ring pattern
change 35
parallel phone systems 82
answering machine
set up with fax (parallel phone systems) 90
set up with fax and modem 91
automatic fax reduction 31

B

backup fax 30
baud rate 36
black and white pages
fax 25
blocked fax numbers
set up 31
buttons, control panel 6

C

cancel
scheduled fax 28
clear
fax logs 39
computer modem
shared with fax (parallel phone systems) 85
shared with fax and answering machine (parallel phone systems) 91
shared with fax and voice line (parallel phone systems) 87
shared with fax and voice mail (parallel phone systems) 94
confirmation reports, fax 38
control panel
buttons 6
features 6
copy
specifications 63
customer support
warranty 57

D

dial type, setting 35
dial-up modem
shared with fax (parallel phone systems) 85

shared with fax and answering machine (parallel phone systems) 91
shared with fax and voice line (parallel phone systems) 87
shared with fax and voice mail (parallel phone systems) 94
distinctive ringing
change 35
parallel phone systems 82
DSL, fax setup with
parallel phone systems 80

E

ECM. See error correction mode
envelopes
specifications 62
environment
Environmental product stewardship program 63
environmental specifications 62
error correction mode 28
error reports, fax 38

F

fax
answer mode 34
answering machine and modem, shared with (parallel phone systems) 91
answering machine, set up (parallel phone systems) 90
auto answer 34
backup fax 30
blocking numbers 31
confirmation reports 38
dial type, setting 35
distinctive ringing setup (parallel phone systems) 82
distinctive ringing, change pattern 35
DSL, set up (parallel phone systems) 80
error correction mode 28
error reports 38
forwarding 31
header 34
Internet Protocol, over 37
ISDN line, set up (parallel phone systems) 81
log, clear 39
log, print 38
manual receive 29
modem and answering machine, shared with (parallel phone systems) 91
modem and voice line, shared with (parallel phone systems) 87

modem and voice mail, shared with (parallel phone systems) 94
modem, shared with (parallel phone systems) 85
monitor dialing 27
paper size 31
parallel phone systems 77
PBX system, set up (parallel phone systems) 81
print last transaction details 39
receive 29
redial options 35
reduction 31
reports 37
reprint 30
rings to answer 34
schedule 28
send 25
separate line setup (parallel phone systems) 79
settings, change 33
setup types 78
shared phone line setup (parallel phone systems) 83
sound volume 36
speed 36
test setup 97
voice mail, set up (parallel phone systems) 84

Fax screen 7
FoIP 37
forwarding faxes 31

H

header, fax 34

I

interface card 47, 48
Internet Protocol
fax, using 37
ISDN line, set up with fax
parallel phone systems 81

J

junk fax mode 31

L

labels
specifications 62
legal paper
specifications 62
letter paper
specifications 62
log, fax
print 38

- M**
- manual faxing
 - receive 29
 - send 26, 27
 - memory
 - reprint faxes 30
 - save faxes 30
 - modem
 - shared with fax (parallel phone systems) 85
 - shared with fax and answering machine (parallel phone systems) 91
 - shared with fax and voice line (parallel phone systems) 87
 - shared with fax and voice mail (parallel phone systems) 94
 - monitor dialing 27
- N**
- network
 - interface card 47, 48
- P**
- paper
 - size, set for fax 31
 - specifications 62
 - parallel phone systems
 - answering machine setup 90
 - countries/regions with 77
 - distinctive ringing setup 82
 - DSL setup 80
 - ISDN setup 81
 - modem and answering machine setup 91
 - modem and voice mail setup 94
 - modem setup 85
 - modem shared with voice line setup 87
 - PBX setup 81
 - separate line setup 79
 - setup types 78
 - shared line setup 83
 - PBX system, set up with fax
 - parallel phone systems 81
 - phone line, answer ring pattern 35
 - phone support 56
 - phone support period
 - period for support 56
 - phone, fax from
 - receive 29
 - send, 26
 - photo paper
 - specifications 62
 - print
 - fax logs 38
 - fax reports 37
 - faxes 30
 - last fax details 39
 - specifications 63
 - printer control panel
 - send faxes 25
 - pulse dialing 35
- R**
- receive faxes
 - auto answer mode 34
 - automatically 29
 - blocking numbers 31
 - forwarding 31
 - manually 29
 - rings to answer 34
 - recycle
 - ink cartridges 64
 - redial options, setting 35
 - reduce fax 31
 - regulatory notices
 - regulatory model identification number 69
 - wireless statements 73
 - regulatory telecom notices 71
 - reports
 - confirmation, fax 38
 - error, fax 38
 - reprint
 - faxes from memory 30
 - rings to answer 34
- S**
- save
 - faxes in memory 30
 - scan
 - scan specifications 63
 - schedule fax 28
 - send faxes
 - basic fax 25
 - manually 26
 - memory, from 27
 - monitor dialing 27
 - schedule 28
 - serial phone systems
 - countries/regions with 77
 - setup types 78
 - settings
 - speed, fax 36
 - volume, fax 36
 - setup
 - answering machine (parallel phone systems) 90
 - answering machine and modem (parallel phone systems) 91
 - computer modem (parallel phone systems) 85
 - computer modem and answering machine (parallel phone systems) 91
 - computer modem and voice line (parallel phone systems) 87
 - computer modem and voice mail (parallel phone systems) 94
 - distinctive ringing 35
 - distinctive ringing (parallel phone systems) 82
 - DSL (parallel phone systems) 80
 - fax scenarios 78
 - fax, with parallel phone systems 77
 - ISDN line (parallel phone systems) 81
 - PBX system (parallel phone systems) 81
 - separate fax line (parallel phone systems) 79
 - shared phone line (parallel phone systems) 83
 - test fax 97
 - voice mail (parallel phone systems) 84
 - voice mail and computer modem (parallel phone systems) 94
 - speed dial
 - send fax 25
 - subscriber identification code 34
 - system requirements 62
- T**
- technical information
 - copy specifications 63
 - environmental specifications 62
 - paper specifications 62
 - print specifications 63
 - scan specifications 63
 - system requirements 62
 - telephone line, answer ring pattern 35
 - telephone, fax from
 - receive 29
 - send 26
 - tests, fax
 - setup 97
 - tone dialing 35
 - transparencies
 - specifications 62
- V**
- voice mail
 - set up with fax (parallel phone systems) 84
 - set up with fax and computer modem (parallel phone systems) 94
 - volume
 - fax sounds 36
- W**
- warranty 57