

MAY 21 1969

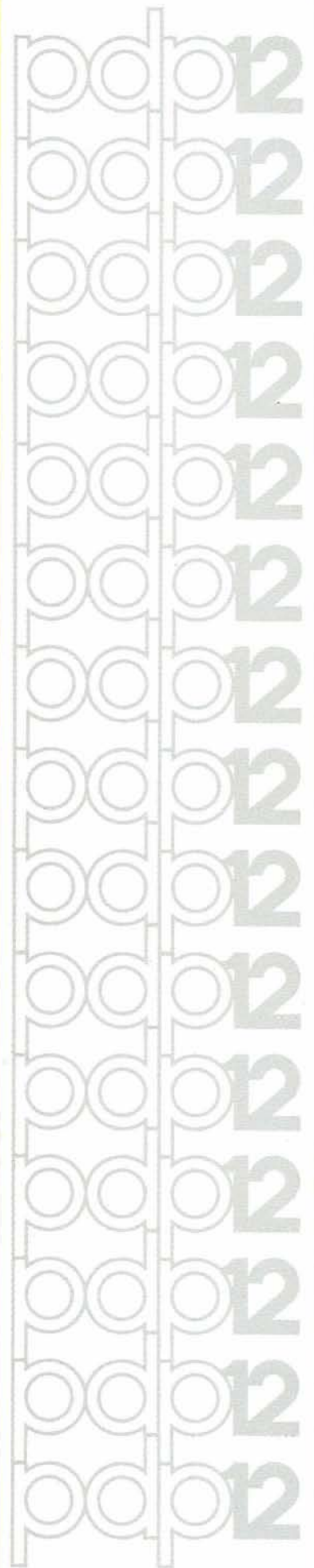

the new pdp-12

Digital's PDP-12 is a complete computer system. It is designed as a simple-to-operate tool for a wide variety of research and real-time data-handling applications.

Performance characteristics of the PDP-12 have been optimized around a complete hardware/software system, rather than around an expandable minimum processor and memory. The PDP-12 system concept works to the advantage of users at all levels of programming sophistication. By simplifying program tasks, the PDP-12 frees users from the mechanics of program preparation to concentrate on more creative aspects of their work.

The following is a brief list of some of the PDP-12's features:

- All new, unified display-based programming system
- Automatic program loading from magnetic tape
- Program debugging hardware
- Seven by nine inch CRT display with graphic and alphanumeric capability
- Large existing library of applications programs
- TTL integrated circuit modules throughout
- LINcTape (addressable bi-directional magnetic tape) for program and data storage
- Free-standing cabinet and console table



applications

Analytical Instrumentation

The PDP-12 can be used to acquire and analyze data from one or more instruments typically used in chemical or physical analysis. Mass spectrometers, gas chromatographs, chemical analyzers, NMR spectrometers, and various particle-size counters are a few of the instruments that may be automated through the use of the PDP-12. This application speeds up the process of obtaining the final data, reduces the number of errors, and performs a more thorough and accurate analysis than is possible when computations are done manually. The PDP-12, with its digital and analog input capabilities for handling the instrumentation signals and its relay outputs for instrument control or range switching, helps eliminate the need for complex special interfaces to several classes of instruments. The cathode ray tube display, with its graphic and alphanumeric capability, allows for the effective presentation of not only data and results but operating instructions which make the PDP-12 easy to use, even by the unskilled operator. The establishment of a question and answer dialogue between the computer and operator allows for an interaction not permitted by most small general purpose computers.

Signal Processing

Typical signal processing requirements within the general laboratory involve the manipulation of data through the use of such mathematical tools as averaging, time interval measurements, frequency analysis, and correlation techniques. The PDP-12 is well suited for this type of data acquisition and analysis for many reasons. It has a buffered analog-to-digital converter which allows analog-to-digital conversion to be initiated by an external source, such as a clock, and does not require any intervention on the part of the processor during the actual conversion of the analog signal. The results are then immediately available to the processor within one machine cycle ($1\frac{1}{2}$ microseconds). This feature allows the processor to continue doing useful work while the actual analog-to-digital conversion process is independently taking place. The data that is being acquired and processed may be transferred to digital magnetic tape, the operation of which is

also completely buffered from the central processor. This allows the program to continue doing its computation while the tape units search for the proper block number and accomplish the transfer of data directly from memory onto magnetic tape, thereby freeing the processor of any tape handling routines. While the buffered CRT display is plotting data on its screen, the processor is free to continue with other tasks.

All these PDP-12 features enhance the machine's throughput capabilities (acquiring and transferring data to some intermediate storage device, such as digital magnetic tape). Throughput rates as high as 7.5 thousand words per second are possible with burst handling capability up to a maximum of 50,000 words per second. This high throughput capability allows the PDP-12 to handle the majority of signal processing chores encountered in real-time laboratory situations.

A library of programs is available to handle a wide variety of typical signal processing applications, such as data averaging, Fourier analysis, time interval histograms, general data acquisition, as well as programs for scanning data already acquired and placed on magnetic tape.

Education

It has become apparent to educators over the past several years that no discipline remains untouched by the revolution in the computer sciences. The use of computers as problem solving tools (computer extended instruction) is being adopted by universities, junior colleges, and high schools throughout the country. In technical curricula, computer usage is being taught as part of process control courses for chemical engineers, computer science courses for electrical engineers, instrumentation courses for medical students, and laboratory courses for speech students, just to name a very few. The computer in these applications is a new and powerful tool to assist in problem solving. The hands-on interactive concept of the PDP-12 makes it particularly well suited for this type of environment. The use of a graphics display through which the machine and operator can communicate, coupled with the ease of operation inherent in its design, has put the

PDP-12 and its predecessors, LINC-8 and LINC computers, in the forefront of computer extended instruction in many universities and technical schools around the world. Extending the computer concept slightly further, to such things as computer mediated instruction and guidance testing, brings into focus another ideal application for the PDP-12. Author-like languages and learning programs have already been written on predecessor machines and are available for experimental work in this field. These software packages, plus inexpensive bulk storage via LINCtape, and ease of programming, make the PDP-12 a highly flexible tool for the innovative researcher.

Bio-Medicine

Bio-médical research is an application to which the PDP-12 is ideally suited. In psychological research, operant behavior, and related fields it can control experiments, record events, and analyze results. It has the capability of handling data inputs and outputs for such things as reinforcements studies. In experiments where humans or animals are presented stimuli to which they respond by pushing buttons or levers, the computer can be used to analyze these results on-line, using standard statistical techniques. The relay contact outputs, digital signal inputs, and manual sense switch branching capabilities from the console make the PDP-12 a powerful and flexible tool for the psychological researcher. The use of inexpensive magnetic tape storage (LINCtape) for both data and programs, coupled with an existing library of statistical packages, graph plotting packages, as well as interviewing programs, provides an excellent starting point from which other programs may be written, to suit the specific needs of the individual researcher.

In physiological studies, the PDP-12 has the capability of handling both analog and digital signals, providing real-time analysis of the information and control of the experiment from which the data is being derived. Programs for handling EKG, EEG, and evoked potentials have already been written for predecessor machines and exist both within the DEC program library and the Digital Equipment Corporation User's Society Library.

Hospital Systems

In the clinical chemistry laboratory the PDP-12's turn-key system provides better patient care, reduces costs, helps relieve the load on the limited number of technicians, handles more tests, and provides better and faster information to the medical staff. This system interprets and processes data simultaneously from up to 15 analytical instruments. It gives automatic readouts, allows continuous monitoring of the process, files and stores results, and does all of the result calculations. A patient filing system allows an accumulative patient summary to be maintained. The computer is able to keep detailed records on each patient, print out periodic summaries, print out summaries on a particular patient on demand, even while it is logging data. At regular intervals the computer is capable of forwarding billing information based upon the tests performed to the accounting department's computer. This will allow the increased work load and record keeping to be performed without imposing a staggering task on the billing department or cause the hiring of additional personnel. The PDP-12 Clinical Laboratory System pays for itself in time otherwise spent in tedious and time-consuming calculations. Also, the operator needs no special training in computer programming. All interfaces and software are supplied by Digital in one easy-to-use turn-key system.

The PDP-12, with its inherent ease of operation, is an ideal tool for use in patient monitoring and patient interviewing. In the patient monitoring situation, EKG, EEG, respiration, etc. can all be handled by the PDP-12 A/D converter and multiplexer. In patient interviewing, the CRT display allows a question and answer dialogue to be established between the patient and the computer while allowing summary printouts via the Teletype. Programs have already been written on predecessor machines for general medical histories and are actually in use in clinical environments. Many new clinical diagnosis systems are being planned and designed. Cytology, multi-phasic screening, and many other systems will benefit from the flexibility and ease of operation of the new PDP-12, with its inherent data gathering capabilities, utilizing digital and analog inputs, as well as its alphanumeric and graphic display capabilities.

software

Due to the unique capability of the PDP-12 to execute two complete instruction sets (the LINC instructions and the PDP-8 family of instructions) a substantial amount of field-proven software is immediately available for use on this system. This software consists of the entire library of PDP-8 programs (both systems programs and applications programs). It is also compatible with the LINC and LINC-8 software, especially in regards to their application programs. To simplify the general programming task and to optimize the advantages of a dual order-code system, a special operating system has been developed. This operating system — a unified, display-based system — represents an ultra-powerful, general-purpose assembler, editor, and monitor for both PDP-8 and LINC programming.

Unified Display-Based Operating System

This sophisticated operating system assumes the use of two tape transports and a display as integral parts of the system. The operating system is composed of an editor, an assembler, a monitor, and data-handling routines for performing the typical functions required in program development.

The operating system is normally in the editor mode, awaiting input information that may be entered via the

```
1
2
3
4
5
6
7
10
11

SAM 4
DIS I 5
SN5 5
JMP -3
RDC
3400
JHP GUS
GUS = 1400

→SP BARBARA,0
```

Display-Based Editor

Teletype, magnetic tape, or paper tape. The command structure of the operating system allows simple and straightforward commands to perform operations such as manipulation (adding, changing, or deleting) of manuscripts, filing of information, copying of manuscripts and data, editing, listing, searching, and assembling.

The editor allows editing on a line-by-line or on a character basis by the use of a controllable cursor on the display. The editor allows random access to any character or line being edited in the text, without resorting to any scheme using paging techniques. The assembler is a two-pass program that is called directly via the monitor. The assembler utilizes additional core and/or disk storage for handling symbols that it cannot contain within the initial 4K of memory. The concept is to maximize the speed at which the assembly can be made. The assembler will handle both PDP-8 and LINC instructions. Six character symbols and tags are used throughout.

4K FORTRAN Compiler

The 4K FORTRAN compiler lets the user express problems in a mixture of English words and mathematical statements. It reduces the time needed for program preparation and enables users with little or no knowledge of the computer's organization and operating language to write effective programs. FORTRAN language consists of four general types of statements: arithmetic, logic, control, and input/output. FORTRAN functions include addition, subtraction, multiplication, division, sine, cosine, arctangent, square root, natural logarithm, and exponentiation.

8K FORTRAN Compiler

(requires 8K of memory and high-speed paper tape)

The 8K FORTRAN compiler translates a source program into a symbolic language, and then the symbolic version of the program is translated into relocatable binary code, the language of the computer. The binary code is punched onto paper tape and then reloaded into the computer for running the program. The 8K FORTRAN system features USA Standard FORTRAN syntax; subroutines; two levels of subscripting; function subprograms; input/output

supervisors; relocatable output loaded by the Linking Loader; COMMON statements; I, F, E, A, X, and H format specifications; and arithmetic and trigonometric library subroutines.

The 8K FORTRAN system consists of the two-pass FORTRAN compiler, Linking Loader, Run-Time Monitor, and a library of subprograms. The system requires 8K of core memory, an ASR33 Teletype, and a high-speed paper tape reader and punch. The compiler utilizes all available core to 32K and is page transparent.

FOCAL

FOCAL (FOrmula CALculator) is a new conversational JOSS-like calculator and programming language developed by Digital. FOCAL has proven to be a powerful tool for solving complex calculations. Of equal importance is FOCAL's role as a teaching aid. A computer novice can begin doing useful work within a few hours using straightforward, simple English commands. Programs can be checked and modified as they are prepared, and FOCAL will tell what went wrong if an error is made. FOCAL features 14 functions, automatic error tracing, character editing, and the power to solve six-level simultaneous equations. FOCAL is available in three versions — 4K, 8K, and 8K Four User. 4K FOCAL uses field zero to store the FOCAL program, the user's program, and the user's variables. 8K FOCAL uses field zero to store the FOCAL program and the user's variables, and uses field one to store the user's program. This allows for storage of much larger user programs. Four User 8K FOCAL, with the proper hardware to connect four Teletypes, gives four users each the power of 4K FOCAL from one computer.

Signal Averaging Program

Signal Averaging Program (requires DW12 and AX08 peripherals) allows for handling of up to 1024 data points per epoch (sweep) and the averaging of this data over

**JOSS is the trade mark and service mark of The Rand Corporation*

a maximum of 4096 sweeps, thus providing a technique for obtaining a valid signal from a noisy environment. Computation of standard deviation, confidence levels, and trend, plus calibration and plotting routines, are included. A dialog is established between the user and the set-up program with the system CRT display and Teletype.

Floating Point Packages

Floating point packages permit the PDP-12 to perform arithmetic operations that could not otherwise be done without the addition of costly hardware. In addition to increasing accuracy, floating point operations relieve the programmer of scaling problems common in fixed-point operations. This is a particular advantage to the inexperienced programmer. The floating point subroutines and interpreters permit the programmer to encode arithmetic operations to either 6 or 10 decimal digits of precision as easily as though the machine had floating point hardware. The operations implemented by the floating point packages include addition, subtraction, multiplication, and division. Other functions in the package are sine, cosine, square root, logarithms, arctangent, and exponentiation.

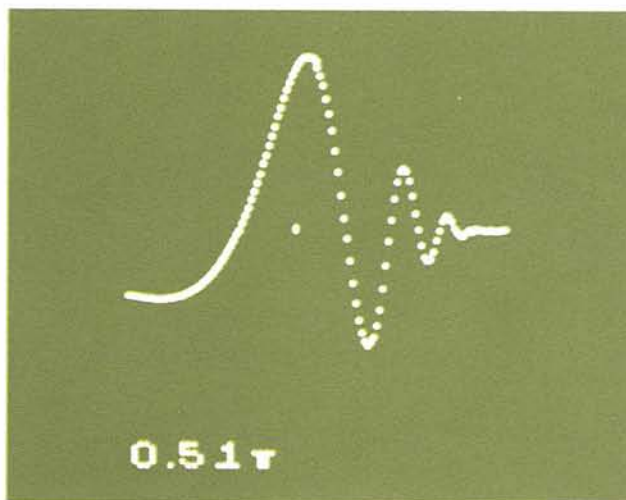

Demonstration Program — simulates a simplified model of the basilar membrane in the inner ear.

Fixed-Point Mathematical Routines

The PDP-12 program library maintains a set of mathematical function routines which perform the following operations in both single and double precision: addition, subtraction, multiplication, division, square root, sine, cosine, arctangent, natural logarithm, and exponentiation. A library of analytic procedures is available which makes readily programmable trigonometric functions, logarithm operations, and procedures such as analysis of variance or fast Fourier transform.

DATA PROGRAMS

(require PDP-12A LINC system)

DATA-12 — This program retrieves, displays, and stores individual data blocks from magnetic tape and provides the user with a repertoire of mathematical operations for manipulating this data. These operations include high and low pass filtration, differentiation and integration, attenuation and amplification, inversion, addition of a

constant, and plotting of a bar graph. The data or resulting waveforms are continuously displayed.

FRQANA — This program performs a frequency analysis of 512 points of data, and resolves the resulting spectrum into 64 components. The sine, cosine, and rms spectra are subsequently displayed and can be scaled. A resynthesis from the spectra can then be performed to provide a comparative display of the original data and the resynthesized waveform.

CURSOR — This program will display on the scope the signal samples from a designated analog input channel or data read into core memory from magnetic tape. Two data files, each 256 points in length, can be handled by CURSOR. A movable cursor, controllable from the front panel, is used to examine the data and display the absolute value of the amplitude.

GRAPHA — This program allows data to be retrieved from magnetic tape and displayed, as well as a graph to

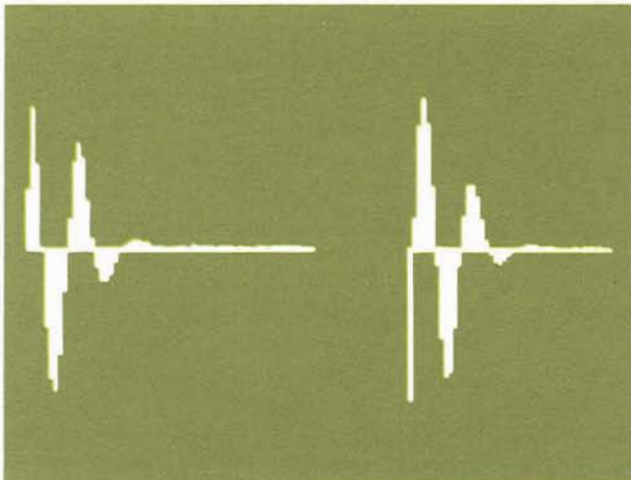

FRQANA Data Program

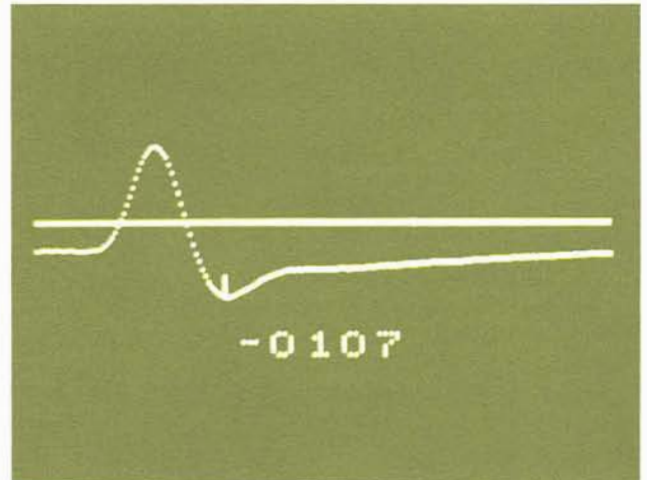

CURSOR Data Program

be composed for this data with appropriate lettering and axes. The graph is assembled on the display and the finished product may be photographed, plotted on an incremental plotter, or saved on magnetic tape for future reference.

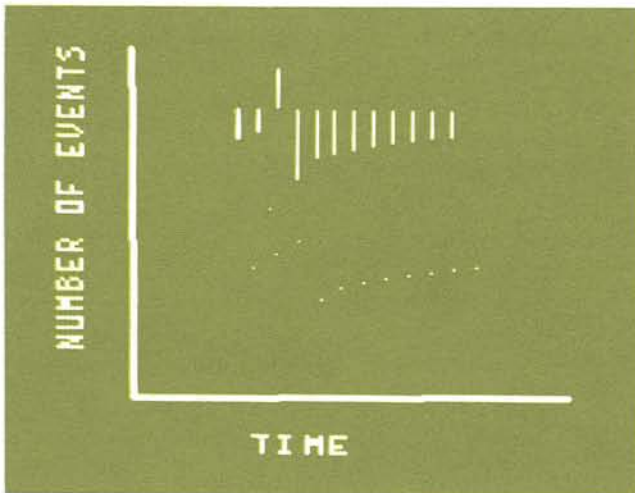

GRAPHA Data Program

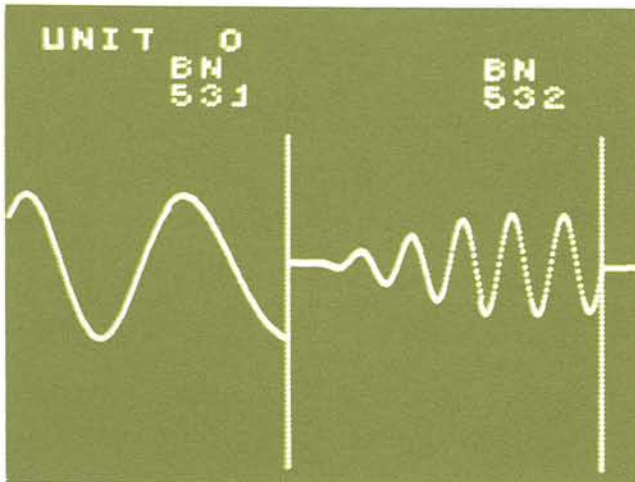

MAGSPY Data Program

MAGSPY — This program provides a moving window for scanning data stored on digital magnetic tape. The data is displayed on the scope and can be scanned at a rate determined by a potentiometer setting. The data can be interpreted either as binary numbers or packed characters.

Utility Programs

A number of utility programs are supplied with the PDP-12. They include programs to provide printouts or punchouts of core memory content in octal, decimal, or binary forms, as specified by the user. Subroutines are provided for octal or decimal data transfer and binary-to-decimal, decimal-to-binary, and Teletype tape conversion. Other utility packages include:

Isometric Plot Subroutine — These programs provide for plotting a function of two variables, $f(x, y)$, isometrically on a digital plotter.

Message Display Subroutine — This is a basic subroutine for displaying lines of text on the scope. It is self-contained, with matrices for all digits, letters, and special characters.

Question and Answer Subroutine — This is a general subroutine used to display a page of text on the scope. Question marks may be displayed and replaced with responses from the keyboard. The information entered in this manner may be recovered by a subsequent portion of the user's program.

Maintenance Programs

A complete set of standard diagnostic programs simplifies and expedites system maintenance. Program descriptions permit the user to test effectively the operation of the computer for proper core memory functioning and proper execution of instructions. Diagnostic programs are provided to check the performance of standard and optional peripheral devices.

hardware

The PDP-12 is a single processor computer system which executes instructions from either of two order codes. The PDP-12 directly executes programs written for the PDP-8 or LINC computer systems.

The PDP-12 combines a totally new hardware organization with advanced system software to make optimal use of its hardware capabilities. Processor control is switched between modes by a single instruction or by console action. All instructions or console functions are directly executed by hardware.

The PDP-12 is a faster, more powerful, and less expensive successor to the LINC-8. Its totally redesigned tape units, display, analog-to-digital converter, and prewired real-time clock offer many new benefits while maintaining program compatibility with previous systems. The input/output bus is compatible with most integrated circuit levels. It operates directly from either processor mode and is identical to those on the PDP-8/L and PDP-8/I.

PDP-12 features:

- 4096 words, 12-bit core memory with 1.6 microsecond cycle time
- Full power processor prewired for the addition of a large number of options and peripherals
- Low-cost core memory expansion to 32,768 words, low-cost mass storage with DECdisks, and IBM-compatible synchronous and incremental magnetic tape
- Worldwide, dependable field service
- Over 4,000 compatible PDP-8, LINC, and LINC-8 family computers in use for sharing programs through Digital's users group (DECUS)
- Single cycle and three cycle direct memory data break facilities, standard
- All active registers continually displayed
- Signed multiple instruction, standard

- Fifteen auto-index registers, standard
- LINC feature to facilitate multiple precision arithmetic
- Both two's complement and one's complement arithmetic.
- 24-bit console switch register
- Six sense switches
- Complete with thirty inch free-standing cabinet, console table, ASR33 teleprinter including paper tape reader and punch
- Twelve digital sense line inputs, standard
- Six single-pole double-throw relay outputs

ELECTRICAL

Power requirements:

15 amperes, average, at 115 volts, 60 cycles single phase. (Other line voltage and frequency ratings are available)

Power requirements:

Under 2 kilowatts

I/O bus levels:

Ground and +3 volts

PHYSICAL

Standard cabinet size:

71" high, 33" wide, 35" deep (including console)

Table:

30" wide, 20" deep

Teletype size:

33" high to top of console, 22 $\frac{1}{4}$ " wide, 18 $\frac{1}{2}$ " deep

Weight:

700 lbs.

ENVIRONMENTAL

Temperature:

40°F to 105°F ambient

Humidity:

20-80%

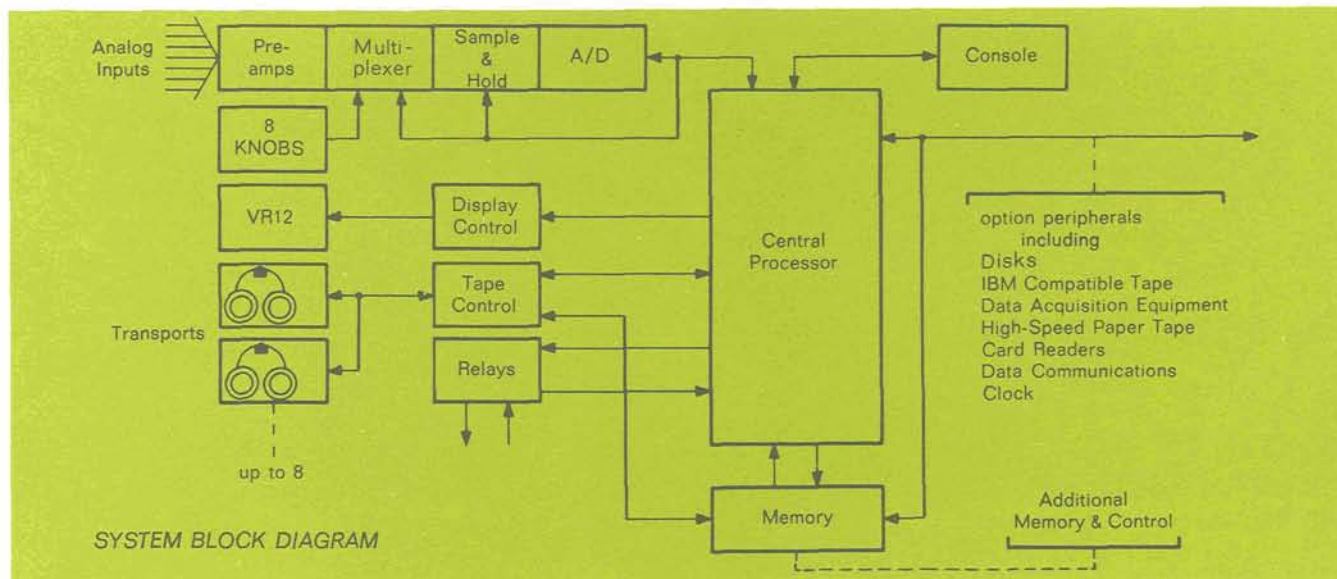

LINC INSTRUCTION FORMATS

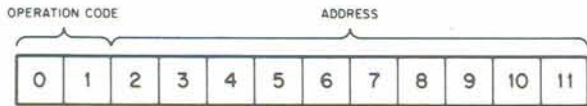

Full Address Class

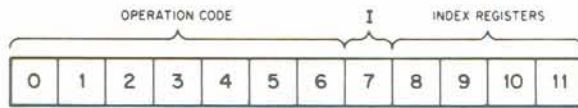

Index - Class

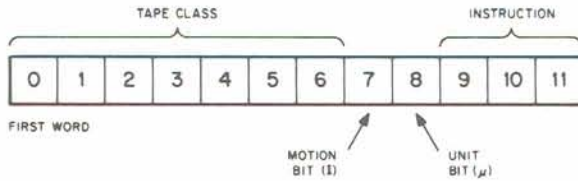

FIRST WORD

MOTION BIT (I)

UNIT BIT (μ)



SECOND WORD

Tape Instruction

The following instructions are used in the LINC mode. The LINC Order Code is built on eleven basic functions as shown in the list that follows

Code	Mnemonic	Function	Time (μsec)
ADD			
2000	ADD	Add memory to AC (IK address)	3.2
1100	ADA	Add memory to AC	3.2
1140	ADM	Add AC to memory (sum also in AC)	3.2
1200	LAM	Add link and AC to memory (sum also in AC)	3.2
MULTIPLY			
1240	MUL	Signed multiply	9
0005	QAC	Load AC with MQ	1.6
LOAD			
1000	LDA	Load AC, full register	3.2
1300	LDH	Load AC, half register	3.2
STORE			
4000	STC	Store and clear AC (IK address)	3.2
1040	STA	Store AC	3.2
1340	STH	Store half AC	3.2
SHIFT/ROTATE			
0240	ROL N	Rotate left N places	1.6-6.4
0300	ROR N	Rotate right N places	1.6-6.4
0340	SCR N	Scale right N places	1.6-6.4
OPERATE			
0000	HLT	Halt	1.6
0016	NOP	No operation	1.6
0011	CLR	Clear AC and Link	1.6
0040	SET	Set register N to contents of register Y	6.4
6000	JMP	Jmp to register Y (IK address)	1.6-3.2
0006	DJR	Disable JMP return	1.6
0004	ESF	AC to spec. fctn. register	1.6
0024	SFA	Spec. fctns. register to AC	1.6

Code	Mnemonic	Function	Time (μsec)
LOGICAL OPERATIONS			
1540	BCL	Bit clear (any combination of 12-bits, logical AND)	3.2
1600	BSE	Bit clear (any combination of 12-bits, inclusive OR)	3.2
1640	BCO	Bit complement (any combination of 12-bits, exclusive OR)	3.2
0017	COM	Complement AC	1.6

SKIP

Code	Mnemonic	Function	Time (μsec)
Skip next instruction if:			
1440	SAE	AC equals memory register Y	3.2
1400	SHD	Right half AC unequal to specified half of memory register Y	3.2
0440	SNS N	Sense switch N is set	1.6
0450	AZE	AC equals zero	1.6
0451	APO	AC contains positive number	1.6
0452	LZE	Link bit equals 0	1.6
0400	SXL N	External level N is present	1.6
0415	KST	Keyboard has been struck	1.6
0454	FLO	Add overflow is set	1.6
0455	QLZ	Bit 11 of MQ register equals 1	1.6
1500	SRO	Rotate memory register right one place, then if bit 11 of Y equals 0 skip next instruction	3.2
0453	IBZ	Between blocks on mag tape	1.6
0446	SKP	Unconditional skip	1.6
0200	XSK	Index memory register Y, skip when contents of Y equal 1777.	3.2
0416	STD	Tape instruction done	1.6
0417	TWC	Tape word completed	1.6

INPUT-OUTPUT

Code	Mnemonic	Function	Time (μsec)
0014	ATR	AC to relay buffer	1.6
0015	RTA	Relay buffer to AC	1.6
0100	SAM N	Sample analog chan N	19.5
0140	DIS	Display point on oscilloscope	3.2
1740	DSC	Display character on oscilloscope (2x6 matrix)	4.8
0516	RSW	Right switch register to AC	1.6
0517	LSW	Left switch register to AC	1.6
0002	PDP	Transfer to PDP-8 program control	1.6
0500	IOB	Execute input-output Bus xfer	5.9

MEMORY

Code	Mnemonic	Function	Time (μsec)
0640	LDF n	Change data field memory bank to bank n	1.6
0600	LIF n	Change instruction field memory bank to bank n	1.6

LINC TAPE

Code	Mnemonic	Function	Time (μsec)	
0702	RDE	Read one block into memory	3.2 plus time dependant on tape position	
0700	RDC	Read and check one block		
0701	RCG	Read and check N consecutive		
0706	WRI	Write one block on tape		
0704	WRC	Write and check one block		
0705	WCG	Write and check N blocks		
0707	CHK	Check one block of tape		
0703	MTB	Move tape toward selected block		
0001	AXO	AC to Ext. operations buffer		1.6
0021	XOA	Ext. operations buffer to AC		1.6
0003	TAC	Tape AC register to AC		1.6
0023	TMA	AC to tape control register	1.6	

Indirect addressing adds 1.6 μsec to given instruction times

PDP-8 INSTRUCTION FORMATS

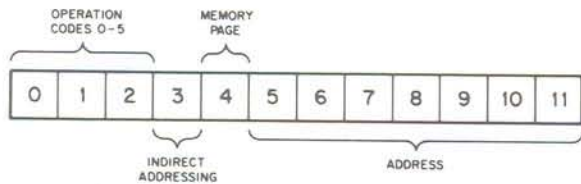

Memory Reference Instruction Bit Assignments

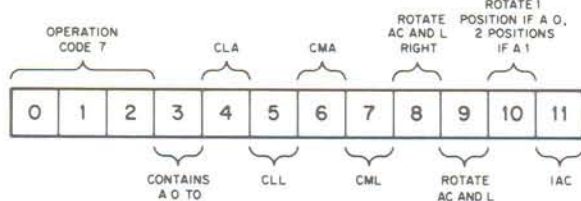

Logical Sequences:

- 1—CLA, CLL
- 2—CMA, CML
- 3—IAC
- 4—RAR, RAL, RTR, RTL

Group 1 Operate Instruction Bit Assignments

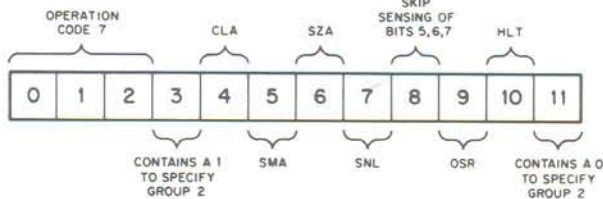

Logical Sequences:

- 1 (Bit 8 is Zero) — Either SMA or SZA or SNL
- 1 (Bit 8 is One) — Both SPA and SNA and SZL
- 2 — CLA
- 3 — OSR, HLT

Group 2 Operate Instruction Bit Assignments

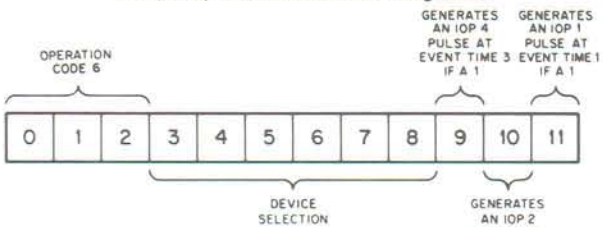

IOT Instruction Bit Assignments

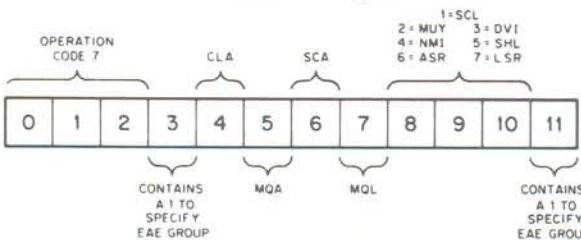

Logical Sequence

- 1 — CLA
- 2 — MQA, MQL, SCA
- 3 (Bits 8 thru 10 = 1) — SCL
- 3 (Bits 8 thru 10 = 2) — MUY
- 3 (Bits 8 thru 10 = 3) — DVI
- 3 (Bits 8 thru 10 = 4) — NMI
- 3 (Bits 8 thru 10 = 5) — SHL
- 3 (Bits 8 thru 10 = 6) — ASR
- 3 (Bits 8 thru 10 = 7) — LSR

EAE Microinstruction Bit Assignments

Code	Mnemonic	Function	Time (μsec)
BASIC INSTRUCTIONS			
0000	AND	logical AND	3.2
1000	TAD	2's complement add	3.2
2000	ISZ	increment and skip if zero	3.2
3000	DCA	deposit and clear AC	3.2
4000	JMS	jump to subroutine	3.2
5000	JMP	jump	1.6
6000	IOT	in/out transfer	4.25
7000	OPR	operate	1.6

GROUP 1 OPERATE MICROINSTRUCTIONS

7000	NOP	no operation	1.6
7200	CLA	clear AC	
7100	CLL	clear link	
7040	CMA	complement AC	
7020	CML	complement link	
7010	RAR	rotate AC and link right one	
7004	RAL	rotate AC and link left one	
7012	RTR	rotate AC and link right two	
7006	RTL	rotate AC and link left two	
7001	IAC	increment AC	

GROUP 2 OPERATE MICROINSTRUCTIONS

7500	SMA	skip on minus AC	1.6
7440	SZA	skip on zero AC	
7510	SPA	skip on plus AC	
7450	SNA	skip on non-zero AC	
7420	SNL	skip on non-zero link	
7430	SZL	skip on zero link	
7410	SKP	skip unconditionally	
7404	OSR	inclusive OR, switch register with AC	
7402	HLT	halts the program	
7600	CLA	clear AC	

COMBINED OPERATE MICROINSTRUCTIONS

7041	CIA	complement and increment AC	1.6
7604	LAS	load AC with switch register	
7120	STL	set link (to 1)	
7204	GLK	get link (put link in AC bit 11)	
7300	CLA	clear AC and link	
7201	CLA	set AC = 1	
7240	CLA	Set AC = -1	
7110	CLL	shift positive number one right	
7104	CLL	shift positive number one left	
7106	CLL	clear link, rotate 2 left	
7112	CLL	clear link, rotate 2 right	
7640	SZA	skip if AC = 0, then clear AC	
7460	SZA	skip if AC = 0 or link is 1, or both	
7650	SNA	skip if AC = 0, then clear AC	
7700	SMA	skip if AC < 0, then clear AC	
7540	SMA	skip if AC < 0	
7520	SMA	skip if AC < 0 or link is 1, or both	
7550	SPA	skip if AC > 0	
7530	SPA	skip if AC > 0, and if the link is 0	
7710	SPA	skip if AC > 0, then clear AC	
7470	SNA	skip if AC = 0 and link = 0	

EAE MICROINSTRUCTIONS

7405	MUY	multiply
7407	DVI	divide
7411	NMI	normalize
7413	SHL	shift left
7415	ASR	arithmetic shift right
7417	LSR	logical shift right
7421	MQL	load AC into MQ, clear AC
7501	MQA	inclusive OR, MQ with AC
7621	CAM	clear AC and MQ
7441	SCA	read SC into AC
7601	CLA	clear AC
7403	SCL	load the step counter

Indirect addressing adds 1.6 μsec to given instruction times

options

The concept of a useful computer system as embodied by the PDP-12 means the optimization of the systems hardware and software around a specific set of input/output devices. These devices include two magnetic tape transports, a large screen CRT display, an analog-to-digital converter and multiplexer, as well as relay closure outputs and sense line inputs. The ability to handle this specific set of input/output devices is designed into the basic instruction set of the PDP-12 and is not considered part of the general I/O bus facility, but rather an integral part of the system. This allows more efficient handling of information to and from the user devices.

LINCtape Control TC12 and TU55 Transports

Digital's PDP-12 LINCtape control is a totally independent tape processor which operates directly into memory on a cycle-stealing basis with the central processor. This system provides an addressable magnetic tape facility for

high-speed loading, read-out, and program updating. A maximum LINCtape configuration with eight TU55 transports, each carrying a tape of standard format to take 131,000 words, can provide over one million words of rapidly accessible storage to the PDP-12. All LINCtape instructions are directly executed by the TC12 control. The user may choose to have programming proceed or pause during tape transfers, which occur at the rate of one 12-bit word every 100 microseconds.

The LINCtape instruction set includes instructions to read, write, and check individual blocks or groups of tape blocks. Each instruction is complete. The tape control does all searching, as well as actual data transfers, without program intervention or the use of memory locations for word count and current address counters.

In addition to the defined LINCtape instructions, an extended addressing mode is provided which allows up to 2048 blocks of any length to be transferred, beginning with any program specified core location. This provides for a maximum of over 200,000 12-bit words per reel of tape.

A controller option TC12-8 is available which allows the PDP-12 to read or write DECTape. This allows for the transfer of data for the purposes of moving information from DECTape to LINCtape, and vice versa, to provide compatibility with other DECTape units on other machines.

LINC Scope Control VC12 and VR12 Display

The PDP-12 display system offers the user direct interaction with a small computer in a way previously unobtainable at a reasonable price.

The VR12 point plotting display offers an 11" diagonal viewing surface (58.5 square inches). The very bright P31 Phosphor allows viewing under normal ambient lighting conditions.

The VC12 buffered display control makes optimal use of the features of the VR12 display scope. The character display instruction (DSC) allows up to 400 characters to be displayed flicker-free in two preset sizes. The display control has its own buffer registers and allows the computer program to continue after initiating the display instruction.

The D/A converter outputs of the display control are buffered, and are capable of driving cables up to 200 feet in length. Two independent intensity channels allow two simultaneous displays to be driven from the same computer on two separate scopes.

Analog-to-Digital Converter and Multiplexer, AD12

The analog-to-digital converter (AD12) includes 16 channels of input through an FET-switched multiplexer which drives a sample and hold circuit. The sample and hold output is converted by the 10-bit A/D converter which is controlled by the LINC mode SAM instruction. Eight of the 16 input channels go directly to the potentiometers which are used by numerous programs as parameter inputs. The remaining eight channels go to differential preamplifiers which provide an input range of ± 1 volt and an input impedance of 70K ohms. The common mode rejection of the preamplifiers is nominally 50 and will pass signals up to 60 KHZ. The preamplifiers provide 10,000 per cent overload protection with microsecond recovery speeds.

The convert time, including multiplexer selection, sample and hold, and conversion, is approximately 19 microseconds. There are two programmed modes of operation in which the converter gives the user the option of pausing until conversion is complete or continuing on with programming.

The multiplexer and preamplifier can be expanded to a total of 32 channels with the addition of the AM12 multiplexer switches and AG12 preamplifiers.

Relay Buffer KD12

The KD12 relay buffer contains a 6-bit register connected to six SPDT relays located on the data terminal panel. These relays can be used for controlling experiments or external equipment. The relay buffer is loaded from the accumulator and may be interrogated in a similar fashion. The contact rating is two amperes at 28 VDC. One ampere at 110 VAC is also acceptable. Contact closure time is approximately 20 milliseconds.

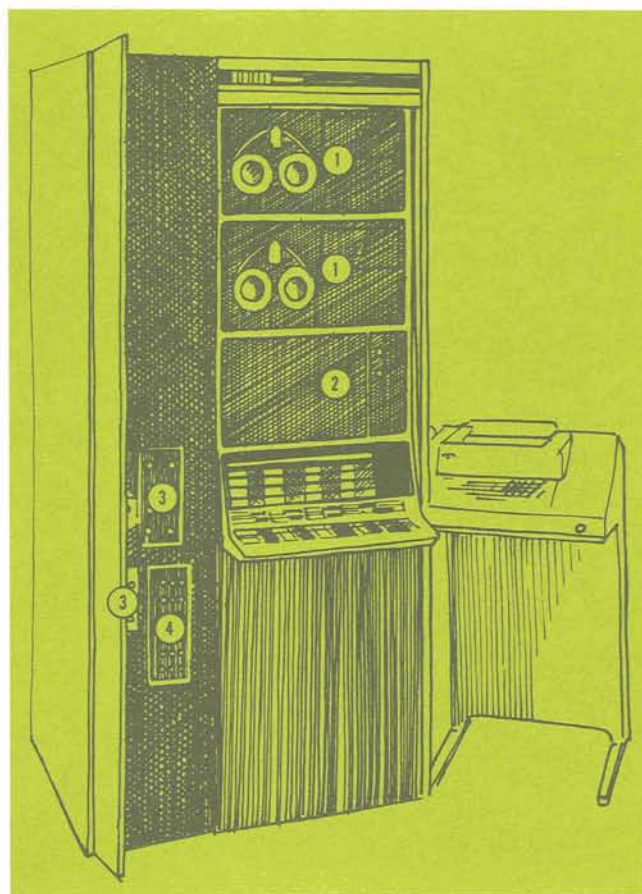

- ① LINCTAPE Control TC12 and TU55 Transports
- ② LINC Scope Control VC12 and VR12 Display
- ③ Analog-to-Digital Converter and Multiplexer, AD12
- ④ Relay Buffer KD12

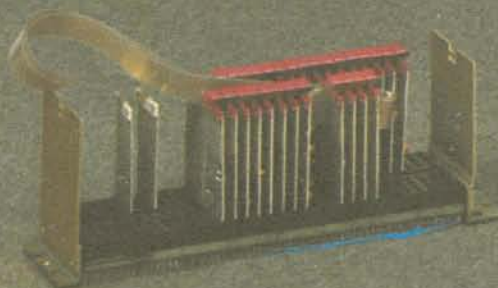
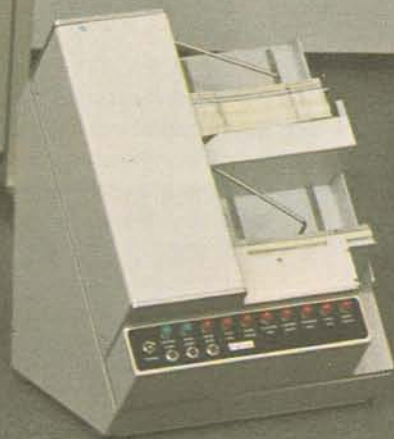
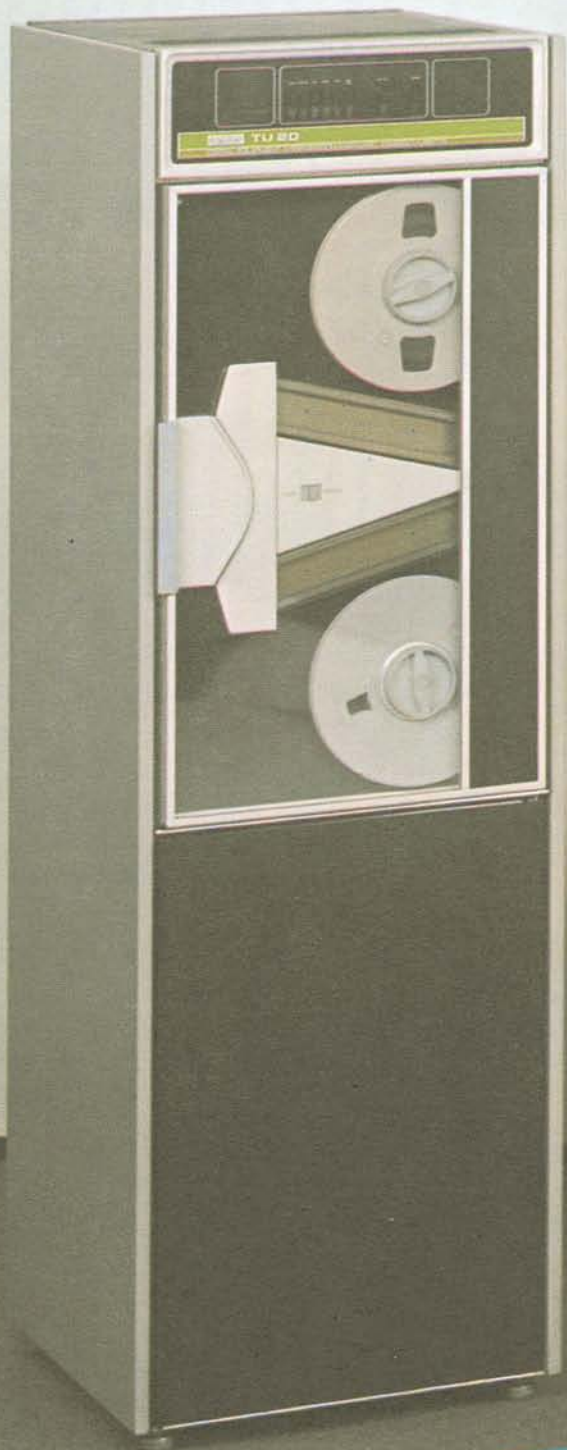

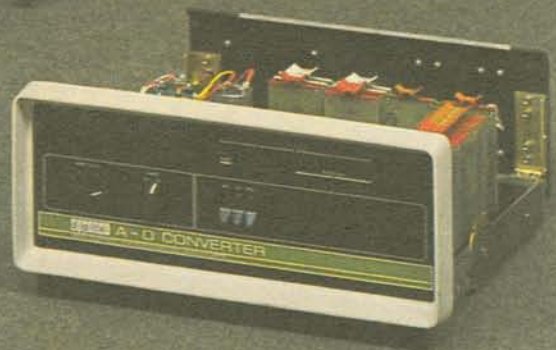
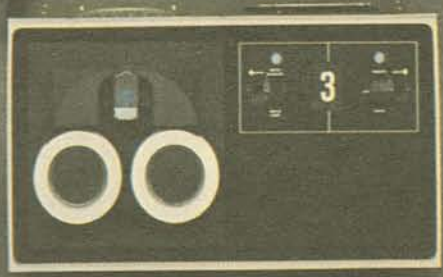
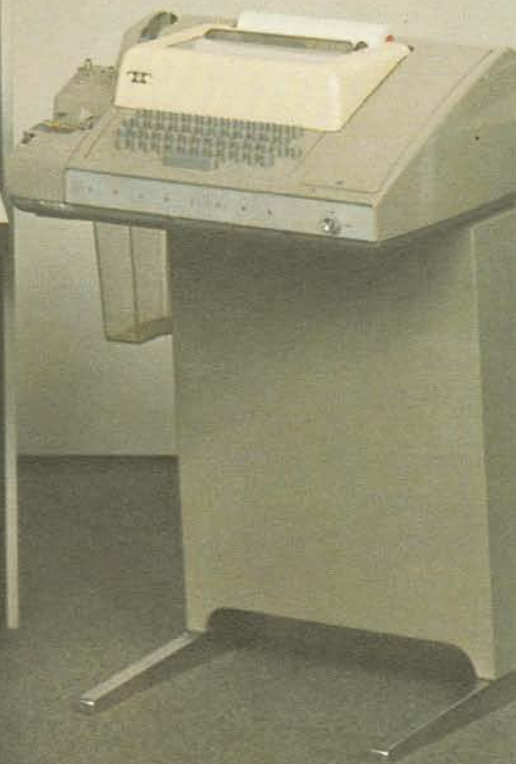
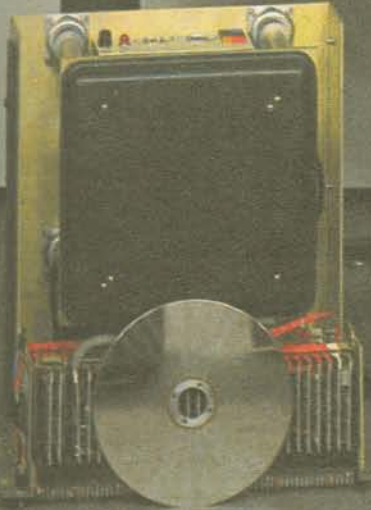
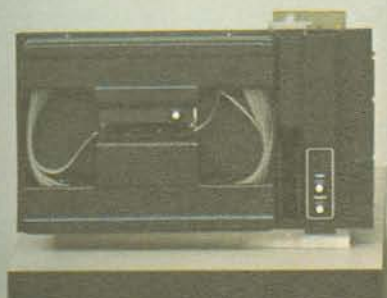
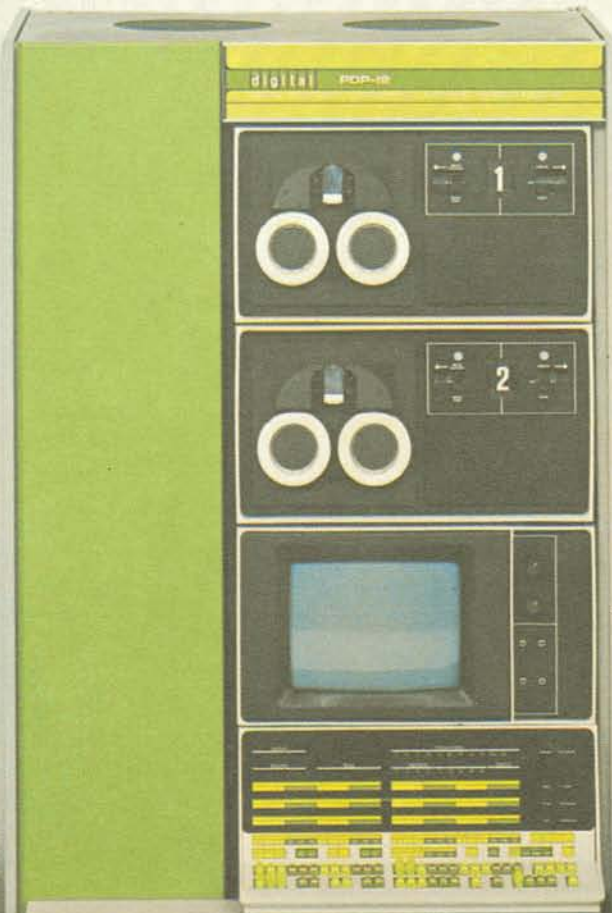



peripherals

The PDP-12 has a complete line of peripherals identical to those offered for Digital Equipment Corporation's PDP-8/I and PDP-8/L. Included are two random access DECdisks, a high-speed paper tape reader and punch, synchronous and incremental IBM-compatible magnetic tape, incremental plotter, data communications equipment, and card readers. All of these are easily interfaced to the PDP-12 in the factory or in the field.

Extended Memory, MC12 and MM8/I

Core memory for the PDP-12 is expanded inexpensively by the addition of up to seven memory modules of 4096 words each. The first memory expansion, MC12, is designed for mounting within the PDP-12 central processor. It requires no additional rack space, and up to six additional 4096-work memory modules (MM8/I's) can be added to the PDP-12, external to the central processor. The memory cycle time is nominally 1.6 microseconds.

Real-Time Clock, KW12

The KW12 real-time clock is designed to solve a wide range of programming requirements. The clock consists of a crystal time base which delivers pulses from a 400 KHertz source at the rate of 400 KHertz, 100 KHertz, 10 KHertz, 1 KHertz, or 100 Hertz. One of these five time bases, or an external signal, can be used to count the 12-bit clock register. A second clock buffer register is used in conjunction with the clock register to provide the following three methods of operation:

- Time of day — the clock register counts at the time base rate. Upon a computer signal, the clock is transferred to its buffer and read into the accumulator. The clock register also provides an overflow flag.
- Preset counter — the buffer is loaded with a preset number from the accumulator. When a clock overflow occurs, the overflow flag is set, the buffer is transferred to preset the clock, and the clock continues to count.

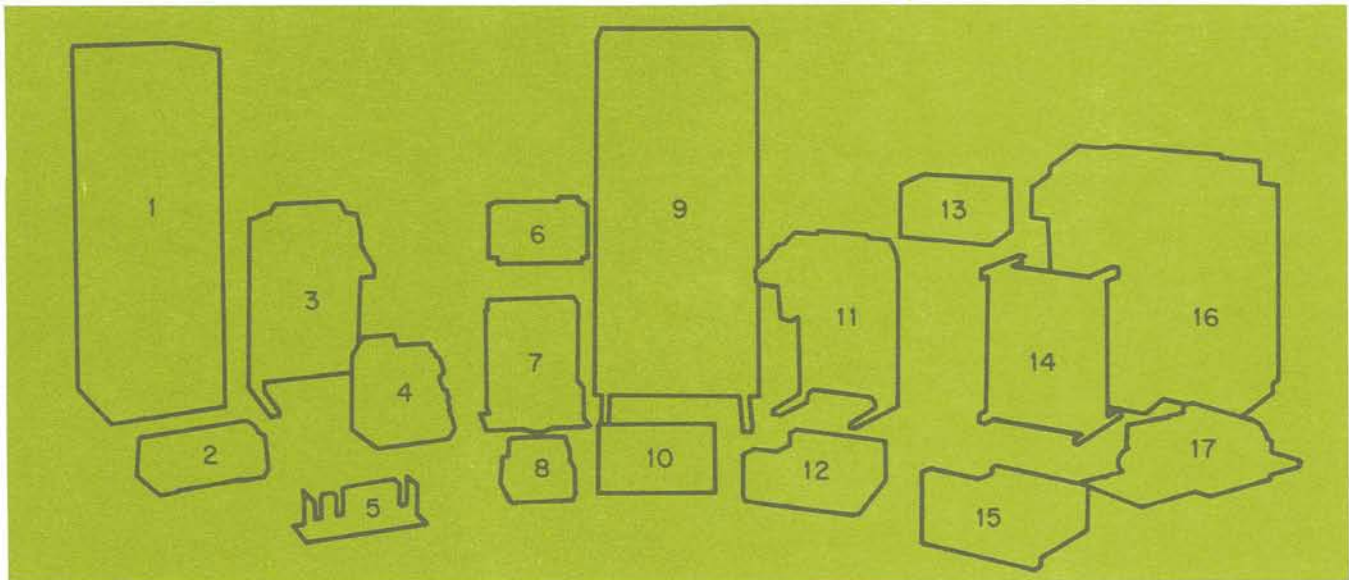

1. TU20 Industry Compatible Magnetic Tape Transports
2. Calcomp Plotter
3. KSR35 Teletype
4. CR12 Card Reader and Control
5. Interface Modules
6. PC12 High Speed Perforated Tape Reader and Punch
7. DF32 DECdisk Random Access Disk File
8. Bell Dataphone (interfaced by a DP12B)
9. PDP-12 Single Processor Computer System
10. TU55 Transport
11. ASR33 Console Teletype
12. AF01 A/D Converter System
13. VR12 Point Plotting Display
14. TR02 Incremental Tape Control
15. AX08
16. LP12 High-Speed Line Printer
17. Houston Complot

- External event timer — the clock counts as in the time-of-day mode. On an external event, the clock is transferred to the buffer and the flag is set. The program can then pick up the time of event from the buffer while the counter continues to run. External signals can also be used to clear the counter. There are three such input channels.

Incremental Plotter Control, XY12

Incremental plotter control XY12 operates one of four models of incremental plotters for 30 inch, 12 inch, or 11 inch paper, and for step sizes of .01 inch or .005 inches. All recording (discrete points, continuous curves, or symbols) is accomplished by the incremental stepping action of the X and Y axes in any one of eight directions. Instructions are used to raise or lower the pen carriage. XY12 plugs directly into the PDP-12, requires no external mounting hardware, and provides a connector that is compatible with either Houston Complot or Calcomp Plotters.

DECdisk Random Access Disk File, DF32

The DECDisk type DF32 is a low-cost, random-access, bulk-storage device and control with a capacity of 32,000 words. Average access time is 16.7 microseconds for 60 cycle operation and the transfer rate is 66 microseconds per word. The DF32 can economically expand the memory capacity of the PDP-12 by providing up to 131,072 words of additional storage using three expander DS32 disks. Data is transferred through the three-cycle data break and uses the DW08A I/O conversion panel option of the PDP-12.

Disk, RS08 and Controller, RF08

Each RS08 Disk and RF08 Controller combination provides storage of 262,144 13-bit words (12 bits plus parity). Four RS08 Disks can be driven by one controller, for a maximum capacity of 1,048,576 words. Data transfer rate on 60-cycle power is 16.7 microseconds per word, and 20

microseconds per word on 50-cycle. Data is transferred through the 3-cycle data break system and I/O conversion panel of the PDP-12. Average access time with a 60-cycle disk is 16.7 milliseconds or 20 milliseconds at 50-cycle power. The RF08 requires the DW08A I/O conversion panel.

Incremental Tape Control, TR02 and Transports

The TR02 control unit transfers data under program control, between the PDP-12 and incremental tape transports. Transports are available for incremental write only or for incremental write and synchronous read. IBM-compatible 7 or 9-channel formats are available with densities of 200, 556, and 800 bpi. The interface requires no operator control and is expandable to control two tape transports. The tape transport's reading speed is 25 inches per second. The incremental writing rate operates at up to 700 steps per second. Tape reels are 8½ inches in diameter. The TR02 interfaces directly to the positive I/O bus of the PDP-12.

Card Reader and Control, CR12

The CR12 card reader handles standard 12-row, 80-column punched cards at 200 cards per minute, in either alphanumeric or binary mode. Cards are read by column beginning with column one. The CR12 requires the BA12 option expander panel.

High Speed Perforated Tape Reader and Punch, PC12

The PC12 includes the PR12 high speed reader and PP12 paper tape punch. It requires the BA12 option expander panel. The high speed reader is valuable as a program-

digital history

In little over a decade Digital Equipment Corporation has become a major force in the computer industry. The company has grown from a small operation with three employees and 8,500 square feet to an international corporation with over a million square feet in plants around the world. From a small manufacturer of digital control modules the company has become the fourth largest manufacturer of computers in the world.

More than 4,000 DEC computers have been installed around the world. In science they have had a tremendous impact in cutting experiment time and providing the researcher with direct, on-line data reduction. DEC computers control and monitor powerful nuclear reactors, control X-ray diffractometers, and analyze nuclear spectroscopy data. They monitor medical data, automatically analyze electrocardiograms, and study the effects of drugs on the nervous system.

DECUS

The Digital Equipment Computer Users Society (DECUS) gives PDP-12 users access to an expanding library of utility programs, subroutines, and other programming materials. They can contribute to and receive DECUSCOPE, a monthly technical newsletter containing user techniques, routines and program summaries. They may attend DECUS annual symposiums and seminars.

ming aid or data input device because of its rapid read-in of perforated tapes. It photoelectrically senses 8-channel, fanfold, perforated tape at 300 characters per second. The companion paper tape punch operates at 50 cps. Both include hoppers for handling fanfold tape, and both the reader and punch are available separately.

AX08

The AX08 integrates in one piece of electronic hardware a 9-bit analog-to-digital converter, preamplifiers, multiplexer, sample-and-hold, converter, timing error flag, Schmitt triggers, crystal-controlled and RC clocks, two 12-bit registers, display control, and power supply. Together with a special programming package, the AX08 is intended to enhance the signal averaging capability of the PDP-12 general purpose computer system. It requires the DW12 I/O expander panel.

Other peripherals include:

- Industry Compatible Magnetic Tape Transports TU20 and Automatic Magnetic Tape Control TC58
- High-Speed Line Printer LP12 — 300 LPM, 132 columns
- General Purpose A/D Converter Systems
 - AF01 — selectable accuracy 6-12 bits with up to 64 multiplexed channels
 - AF04 — guarded, scanning IDVM. 5uv resolution and auto-ranging features. 140 db CMR
 - AM08 — analog multiplexer for up to 1024 channels
- Digital-to-Analog Converter AA01 and Control AA05
- Data Communications Systems
 - IBM 360 Data Link DX36
 - Additional Serial Line (TTY) Interface DP12
 - Multiple Teletype System DC02
- Interface Modules
- Special Systems
- Peripheral Expander Panel
- I/O Bus Converter
- Power Failure and Turn-on Detection
- Teletypes

field service

A world-wide field service staff insures the proper maintenance of DEC machines. One of the company's over 500 field service engineers can be on the spot in a few hours if a problem develops. If a few hours is not fast enough, a resident engineer can be located at a site full time.

For small computer users, DEC also offers unique depot repair stations. Located at strategic Digital service centers, each station is a complete service lab manned with full time engineers and equipped with sophisticated test equipment.

WORLD-WIDE SALES AND SERVICE

MAIN OFFICE AND PLANT

DIGITAL EQUIPMENT CORPORATION
 146 Main Street, Maynard, Massachusetts 01754
 Telephone: From Metropolitan Boston: 646-8600
 Elsewhere: (617)-897-5111
 TWX: 710-347-0212 Cable: Digital Mayn. Telex: 94-8457

DOMESTIC

NORTHEAST

NORTHEAST OFFICE:

146 Main Street, Maynard, Massachusetts 01754
 Telephone: (617)-646-8600 TWX: 710-347-0212

BOSTON OFFICE:

899 Main Street, Cambridge, Massachusetts 02139
 Telephone: (617)-491-6130 TWX: 710-320-1167

ROCHESTER OFFICE:

480 Clinton Avenue, So., Rochester, New York 14620
 Telephone: (716)-454-2000 TWX: 510-253-3078

NEW HAVEN OFFICE:

129 College Street, New Haven, Connecticut 06510
 Telephone: (203)-777-5797 TWX: 710-465-0692

MID-ATLANTIC - SOUTHEAST

MID-ATLANTIC OFFICE:

Route 1, Princeton, New Jersey 08540
 Telephone: (609)-452-9150 TWX: 710-987-8319

NEW YORK OFFICE:

Suite #1
 71 Grand Avenue, Palisades Park, New Jersey 07650
 Telephone: (201)-941-2016 or (212)-594-6955
 TWX: 710-992-8974

NEW JERSEY OFFICE:

1259 Route 46, Parsippany, New Jersey 07054
 Telephone: (201)-335-3300 TWX: 710-987-8319

PRINCETON OFFICE:

Route One and Emmons Drive,
 Princeton, New Jersey 08540
 Telephone: (609)-452-2940 TWX: 510-685-2337

LONG ISLAND OFFICE:

1919 Middle Country Road
 Centereach, L.I., New York 11720
 Telephone: (516)-585-5410 TWX: 510-228-6505

PHILADELPHIA OFFICE:

1100 West Valley Road, Wayne, Pennsylvania 19087
 Telephone: (215)-687-1405 TWX: 510-668-4461

WASHINGTON OFFICE:

Executive Building
 7100 Baltimore Ave., College Park, Maryland 20740
 Telephone: (301)-779-1100 TWX: 710-826-9662

CANADA

CANADIAN OFFICE:

Digital Equipment of Canada, Ltd.
 150 Rosamond Street, Carleton Place, Ontario
 Telephone: (613)-257-2615 TWX: 610-561-1651

OTTAWA OFFICE:

120 Holland Street, Ottawa 3, Ontario
 Telephone: (613)-725-2193 TWX: 610-561-1651

TORONTO OFFICE:

230 Lakeshore Road East, Port Credit, Ontario
 Telephone: (416)-278-6111 TWX: 610-492-4306

MONTREAL OFFICE:

640 Cathcart Street, Suite 205, Montreal, Quebec
 Telephone: (514)-861-6394 TWX: 610-421-3690

EDMONTON OFFICE:

Digital Equipment of Canada, Ltd.
 5531-103 Street
 Edmonton, Alberta, Canada
 Telephone: (403)-434-9333 TWX: 610-831-2248

GERMANY

COLOGNE OFFICE:

Digital Equipment GmbH
 5 Koeln, Neue Weyerstr. 10, West Germany
 Telephone: 23 55 01 Telex: 841-888-2269
 Telegram: Flip Chip Koeln

MUNICH OFFICE:

8 Muechen 2, Theresienstr. 29, West Germany
 Telephone: 28 30 53 Telex: 841-524226

MID-ATLANTIC - SOUTHEAST (cont.)

CHAPEL HILL OFFICE:

P.O. Box 1186, Chapel Hill, North Carolina 27514
 Telephone: (919)-929-4095

HUNTSVILLE OFFICE:

Suite 41 — Holiday Office Center
 3322 Memorial Parkway S.W., Huntsville, Ala. 35801
 Telephone: (205)-881-7730 TWX: 810-726-2122

COCOA OFFICE:

412 High Point Drive, Cocoa, Florida 32922
 Telephone: (305)-632-9283 TWX: 510-957-1448

ATLANTA OFFICE:

Suite 116, 1700 Commerce Drive, N.W.,
 Atlanta, Georgia 30318
 Telephone: (404)-351-2822 TWX: 810-751-3251

KNOXVILLE OFFICE:

Digital Equipment Corporation
 5731 Lyons View Dr., S.W., Knoxville, Tenn. 37919
 Telephone: (615)-588-6571 TWX: 810-583-0123

CENTRAL

PITTSBURGH OFFICE:

400 Penn Center Boulevard,
 Pittsburgh, Pennsylvania 15235
 Telephone: (412)-243-8500 TWX: 710-797-3657

CHICAGO OFFICE:

69 North Broadway, Des Plaines, Illinois 60016
 Telephone: 312-299-0144 TWX: 910-233-0894

ANN ARBOR OFFICE:

3853 Research Park Drive, Ann Arbor, Michigan 48104
 Telephone: (313)-761-1150 TWX: 810-223-6053

MINNEAPOLIS OFFICE:

Digital Equipment Corporation
 15016 Minnetonka Industrial Road
 Minnetonka, Minnesota 55343
 Telephone: (612)-935-1744 TWX: 910-576-2818

CLEVELAND OFFICE:

Park Hill Bldg., 35104 Euclid Ave.
 Willoughby, Ohio 44094
 Telephone: (216)-946-8484 TWX: 810-427-2608

ST. LOUIS OFFICE:

Suite 110, 115 Progress Parkway, Maryland Heights
 St. Louis, Missouri 63042

INTERNATIONAL

ENGLAND

READING OFFICE:

Digital Equipment Co. Ltd.
 Arkwright Road, Reading, Berkshire, England
 Telephone: Reading 85131 Telex: 84327

MANCHESTER OFFICE:

13/15 Upper Precinct, Walkden
 Manchester, England m28 5az
 Telephone: 061-790-4591/2 Telex: 668666

LONDON OFFICE:

Digital Equipment Co. Ltd.
 Bilton House, Uxbridge Road, Ealing, London W.5.
 Telephone: Reading 85131 Telex: 84327

FRANCE

PARIS OFFICE:

233 Rue de Charenton, Paris 12, France
 Telephone: 344-70-46 TWX: 21339

BENELUX

THE HAGUE OFFICE:

Digital Equipment N.V.
 Koninginnegracht 65, The Hague, Netherlands
 Telephone: 635960 Telex: 32533

SWEDEN

STOCKHOLM OFFICE:

Digital Equipment Aktiebolag
 Vretenvagen 2, Solna 1, Stockholm, Sweden
 Telephone: 98 13 90
 Telex: Digital Stockholm 17050
 Cable: Digital Stockholm

CENTRAL (cont.)

DAYTON OFFICE:

3101 Kettering Blvd., Dayton, Ohio 45439
 Telephone: (513)-299-7377 TWX: 810-459-1676

DALLAS OFFICE:

1625 W. Mockingbird Lane, Suite 309
 Dallas, Texas 75235
 Telephone: (214)-638-4880

HOUSTON OFFICE:

3417 Milam Street, Suite A, Houston, Texas 77002
 Telephone: (713)-524-2961 TWX: 910-881-1651

WEST

WESTERN OFFICE:

560 San Antonio Road, Palo Alto, California 94306
 Telephone: (415)-328-0400 TWX: 910-373-1266

ANAHEIM OFFICE:

801 E. Ball Road, Anaheim, California 92805
 Telephone: (714)-776-6932 or (213)-625-7669
 TWX: 910-591-1189

WEST LOS ANGELES OFFICE:

2002 Cotner Avenue, Los Angeles, California 90025
 Telephone: (213)-479-3791

SAN FRANCISCO OFFICE:

560 San Antonio Road, Palo Alto, California 94306
 Telephone: (415)-326-5640 TWX: 910-373-1266

ALBUQUERQUE OFFICE:

6303 Indian School Road, N.E.
 Albuquerque, N.M. 87110
 Telephone: (505)-296-5411 TWX: 910-989-0614

DENVER OFFICE:

2305 South Colorado Blvd., Suite #5
 Denver, Colorado 80222
 Telephone: 303-757-3332 TWX: 910-931-2650

SEATTLE OFFICE:

1521 130th N.E., Bellevue, Washington 98004
 Telephone: (206)-454-4058 TWX: 910-433-2306

SALT LAKE CITY OFFICE:

431 South 3rd East, Salt Lake City, Utah 84111
 Telephone: (801)-328-9838 TWX: 910-925-5834

AUSTRALIA

SYDNEY OFFICE:

Digital Equipment Australia Pty. Ltd.
 75 Alexander Street, Crows Nest, N.S.W. 2065, Australia
 Telephone: 439-2566 Telex: AA20740
 Cable: Digital, Sydney

MELBOURNE OFFICE:

Digital Equipment Australia Pty. Ltd.
 60 Park Street, South Melbourne, Victoria, 3205
 Telephone: 696 142 Telex: AA30700

WESTERN AUSTRALIA OFFICE:

69 Outram Street, West Perth, Western Australia 6005
 Telephone: 23-2091 Telex: AA 92140

BRISBANE OFFICE:

Digital Equipment Australia Pty. LTD.
 139 Merivale Street, South Brisbane,
 Queensland 4000, Australia
 Telephone: 44047 Telex: AA290 40616

JAPAN

TOKYO OFFICE:

Rikei Trading Co., Ltd. (sales only)
 Kozato-Kaikan Bldg.
 No. 18-14, Nishishimbashi 1-chome
 Minto-ku, Tokyo, Japan
 Telephone: 5915246 Telex: 7814208
 Digital Equipment Corporation International
 (engineering and services)
 Fukuyoshicho Building, No. 2-6, Roppongi 2-Chome,
 Minato-Ky, Tokyo
 Telephone No. 585-3624 Telex No.: 0242-2650