

Bridging the Atlantic

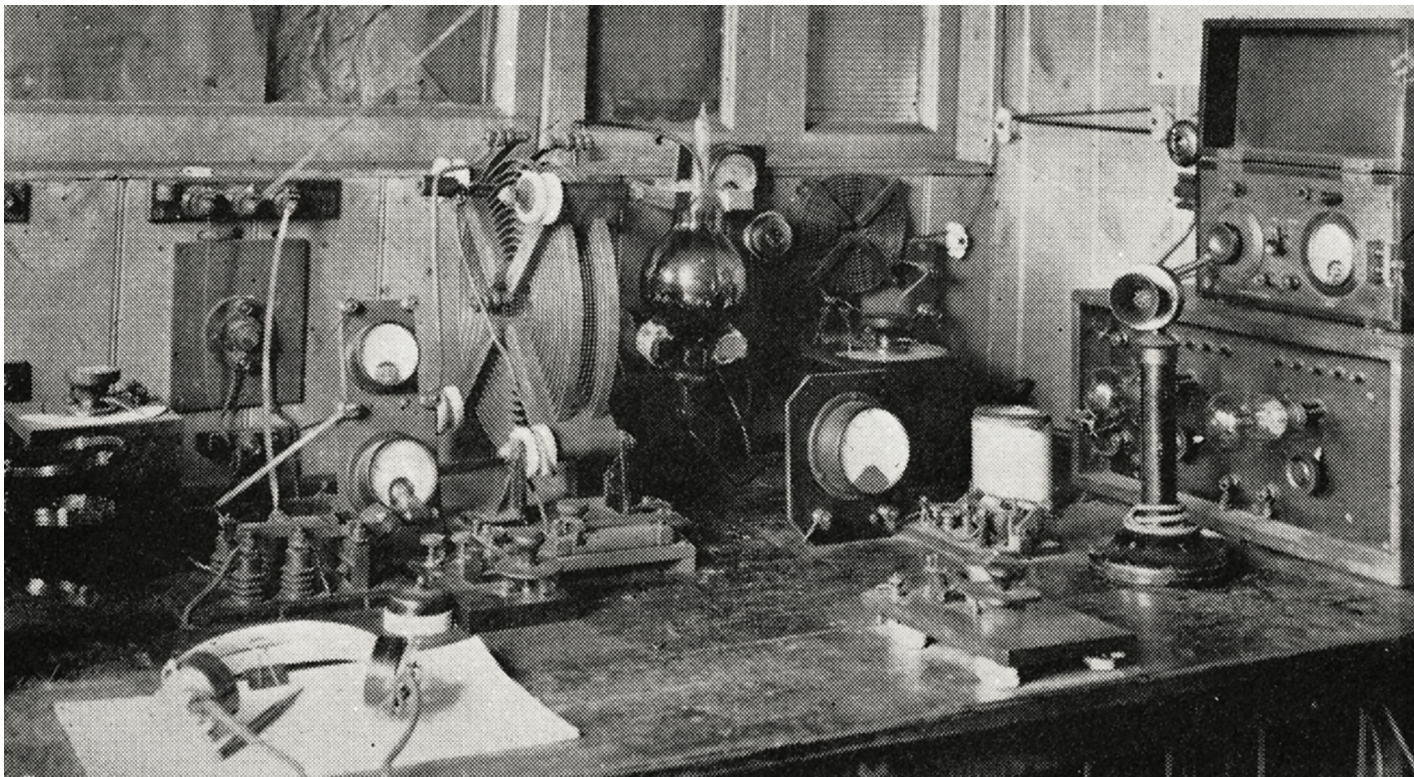

Jack Partridge, 2KF, achieved the first UK - US contact with this station in London on 8 December 1923. (RSGB).

The first short wave trans-Atlantic amateur radio contacts launched a major communications revolution.

Whether by sailing ship, submarine cable, or wireless waves; the challenge of crossing the Atlantic Ocean has always captured the imagination of adventurers and pioneers. Well before the Postmaster General had been persuaded to restore limited transmitting rights to British radio amateurs after WWI, Marconi had established reliable wireless telegraphy links between Britain and North America. But the resources needed to achieve this had been colossal.

His 300kW long wave (6,667 metre) transmitter near Clifden, on the west coast of Ireland, was powered by six steam engines; their hungry boilers fired by peat transported from the surrounding bogs by special light railway. The antenna, directed towards its sister station at Glace Bay in Nova Scotia, was supported by eight 210ft masts, and occupied an area 200ft wide and 1000ft

long [1]. The huge 15kV condenser was composed of 1,800 steel sheets, each 30ft by 12ft, suspended from the roof of a building 350ft long by 75ft wide. And when the station was transmitting, the ear-splitting crashes of its disc spark discharger could be heard throughout the surrounding area.

Compared with this, British amateurs were restricted by the GPO to a maximum power input of 10W and a total antenna wire length not exceeding 100ft. Small wonder that with these limitations and the rudimentary technology of the early 1920s, the possibility of a 3,000km transatlantic amateur QSO seemed remote.

First steps

But in the New World radio regulation was much more liberal, for there had been a view that the radio spectrum was a natural resource that in peacetime could be used freely by any American citizen. Although the US Navy had attempted to retain control of all wireless communications after the war, this move had been thwarted by commercial and amateur interests. Many US amateur

stations had 1kW CW or spark transmitters, antenna size was not limited and contacts over several hundred miles were becoming commonplace. So in September 1920 Milton Sleeper, the radio editor of *Everyday Engineering*, proposed that a series of tests be organised in which British amateurs would try to receive signals from a selection of 25 of the best-equipped US stations, on the 'useless' wavelength of 200 metres to which they had been banished.

The driving force for these tests in Britain was Philip Coursey, 2JK, an experienced engineer with the Dubilier Condenser Co who had been an assistant to Ambrose Fleming (of diode valve fame) and became Honorary Secretary of the RSGB in 1924. Coursey publicised the tests through the Wireless Society of London, the forerunner of the RSGB, and after several radio manufacturers offered handsome prizes, over 250 British amateurs declared they would take part. The ARRL organised the US transmissions, which took place on 2, 4 and 6 February 1921 during the early hours of the morning in Britain, when most of the Atlantic path was in darkness. Early receivers had limited

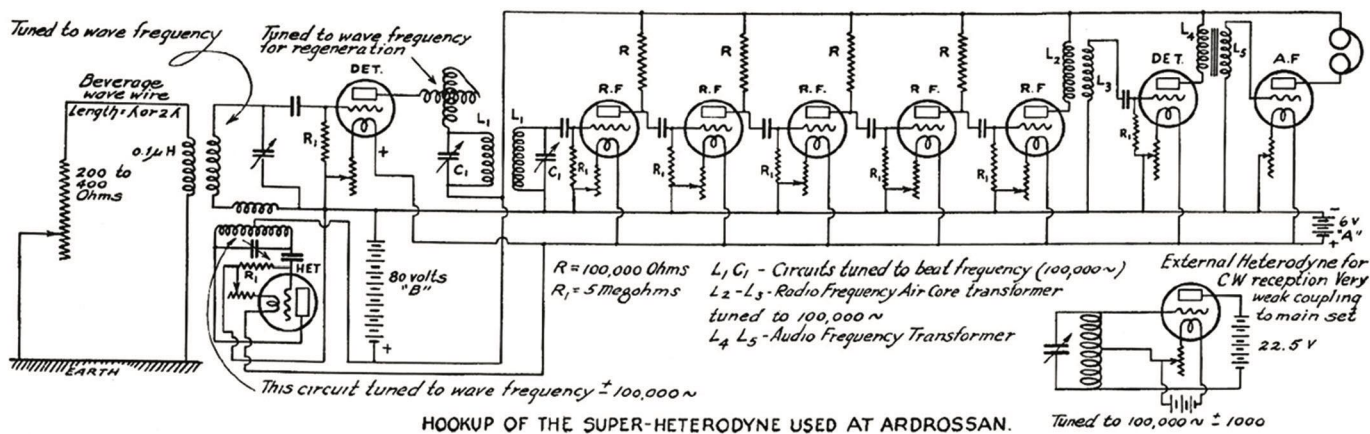

State of the receiver art in 1921. Godley's superhet had one regenerative RF amplifier, five RC-coupled IF stages and one AF amplifier. The BFO was a separate oscillator loosely coupled to the detector. (ARRL).

selectivity and Coursey appealed to all British amateurs to observe radio silence during the tests. To avoid any false claims of reception, the US stations transmitted secret code words in addition to their call signs and on one night they also sent pre-assigned portions of a text.

To the disappointment of all participants the tests were a complete failure, not one British listener having received a signal that could unquestionably be attributed to an American amateur. With hindsight, since short wave radio conditions can be variable it was an error to limit the tests to only three short sessions. Although no-one qualified for the reception prizes, W R Wade of Bristol was awarded a 3-valve Burnham audio amplifier for the description of the receiver he used, which was a fine home-built design with

7 valves, including a separate heterodyne oscillator.

Aftermath

It was understandable that Kenneth Warner, the Editor of QST, should blame the negative result on the lack of experience of the British amateurs, as well as on the "decidedly inferior" circuits of their receivers. But no British station is far from the sea and the wideband splatter from ship-to-shore communications by outmoded spark transmitters had proved a source of troublesome interference. Apart from the short duration of the tests, the entrants also complained that they had to contend with severe interference from the harmonics of high power European commercial stations (such as Nantes)

operating on longer wavelengths, as well as radiation from the self-heterodyne receivers of other participants. This was a problem that was later to plague the fledgling broadcasting industry for many years.

There was great enthusiasm on both sides of the Atlantic for further tests the following winter and these were scheduled on the nights of 8 to 17 December 1921. This time round the sessions were extended to 6 hours per night, with the first 2½ hours being a free-for-all, followed by a period reserved for the selected 20 CW and 7 spark qualifying stations. More than 12 British companies offered prizes, including three Burndept receivers, a Sullivan laboratory wavemeter worth £35 and three cash prizes from the Marconi Scientific Instrument Co.

In May 1921, Warner had written that, "if a good US amateur with ... an Armstrong Super could be sent to England, reception of US amateurs would straightway become commonplace" [2]. So at the first ARRL Convention in Chicago in September, the Board of Directors unanimously voted the funds to send a US amateur to Britain for the tests. Thus began one of the strangest DXpeditions in amateur radio history.

Welcome to Britain

As a "good US amateur" to show the British how it should be done, the ARRL Board could not have made a better choice. 32 year-old Paul Godley, whose home call was 2ZE, was a recognised wireless expert who had developed the Paragon line of receivers for Adams-Morgan, before working for Marconi during WWI and later starting his own

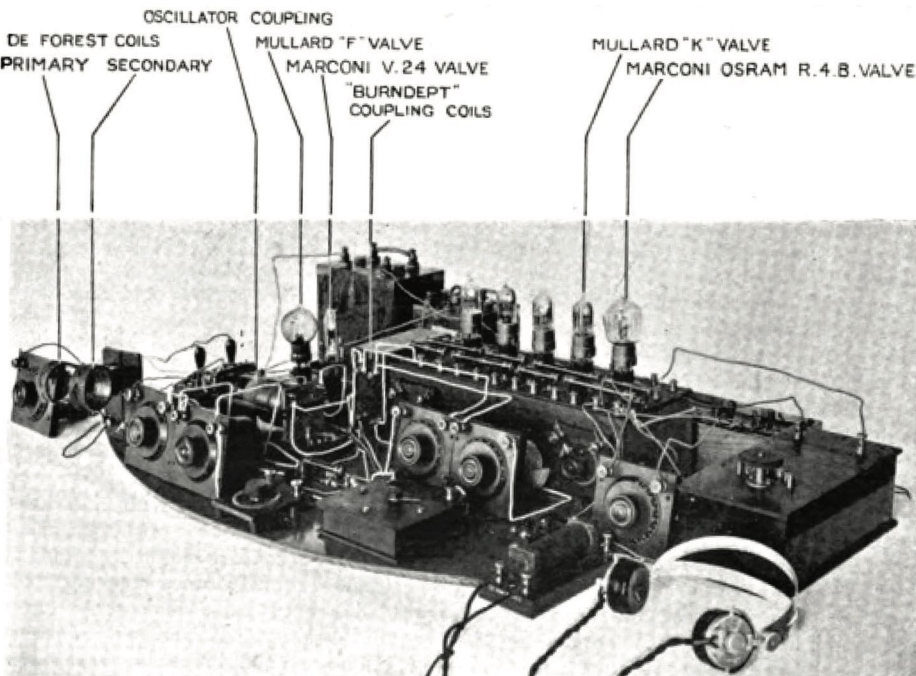

Wade's homebuilt 7-valve superhet was awarded first prize in the 1st transatlantic tests. (Wireless World).

Dr Bruce Taylor, HB9ANY
bgtaylor@iee.org

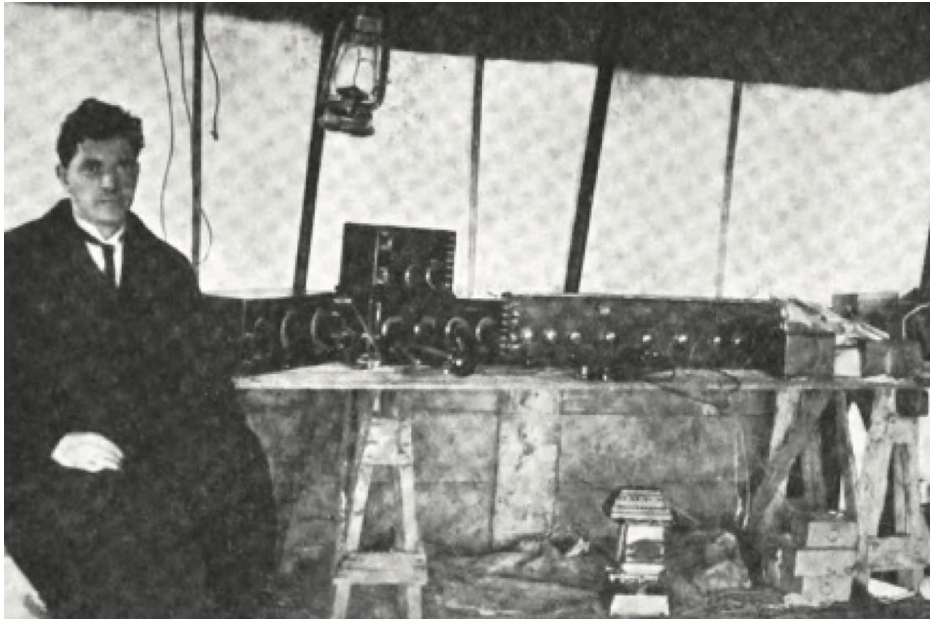

Marconi Inspector Pearson with Godley's receivers in the tent at Ardrossan. (*Wireless World*).

Ardrossan

Godley had already chosen Ardrossan as his 'Plan B' site if conditions near London proved unsatisfactory. The village had a railway link to Glasgow and was well situated on the North Ayrshire coast with a clear outlook to the west over the Firth of Clyde. As in London, Godley received a royal welcome north of the border. He was met in Glasgow by two representatives of the Marconi International Marine Communication Co (MIMC Co), whom he found extremely helpful in obtaining a tent, antenna poles, GPO insulators, wire, accumulators and other accessories such as a lantern and oil heating stove. On 5 December he arrived in Ardrossan and with the enthusiastic help of the Town Clerk, Police Sergeant and other worthy citizens, he selected a site for his tent in a farmer's field, albeit one that had been covered with seaweed as fertiliser. He was joined by D E Pearson, the MIMC Co District Inspector, who assisted him throughout the whole period of the tests.

company. The equipment he chose to take to Britain included a Paragon regenerative set, a tuner, and a 9-valve superhet with a regenerative radio frequency amplifier stage and local oscillator, followed by five RC-coupled amplifier stages with input and output circuits tuned to the intermediate frequency of 100kHz. For CW reception, a harmonic signal from a separate beat frequency oscillator was loosely coupled to the detector feeding the final audio output amplifier. There were individual filament rheostats for all 10 valves.

When Godley sailed from New York on the *Aquitania* on 15 November, he was surprised to find that RCA's receiver designer, Harold Beverage, 2BML, was also a passenger. It was during the voyage that Beverage suggested to Godley that he use his long wire 'wave antenna' for the tests, instead of the vertical that he had planned. Because of the directional characteristics of the Beverage antenna, this suggestion may have been critical to the success of his venture.

When the *Aquitania* docked in Southampton on 22 November, Godley was met by the local Marconi Co superintendent, who helped him import his radio gear before he travelled on to a lavish reception in London. During his stay in the capital he received VIP treatment. A dinner was held in his honour, and he attended a lecture at the Royal Institution and met such notables as Marconi, Fleming, Jackson, Swinton and Hope-Jones, as well as the Chief Engineer of the GPO Wireless Section. He then set up his receiver at the Wembley Park home of Frank Phillips, who had designed the Burndep III grand prize receiver, to sample reception conditions in the London area.

After five nights of fruitless listening until 4.30am, Godley had had enough. The atmospheric noise (QRN) was something he had never experienced in winter in the US. He also found the short wave band crowded with harmonics from powerful commercial single valve and Poulsen Arc transmitters, as well as spark splatter from Poldhu. So he rapidly obtained a new one-month operating permit from the GPO and set off to seek quieter conditions in Scotland.

Local labourers installed a ground system of buried iron pipes, and a line of wooden poles across the field to support the 1300ft Beverage antenna wire at 12ft above the ground. Despite strong winds, freezing temperatures, drenching rain and muddy conditions, Godley and Pearson managed to get their tent erected and all the equipment installed just before the first transmissions were due. Firing up his superhet, Godley found that harmonics were much less

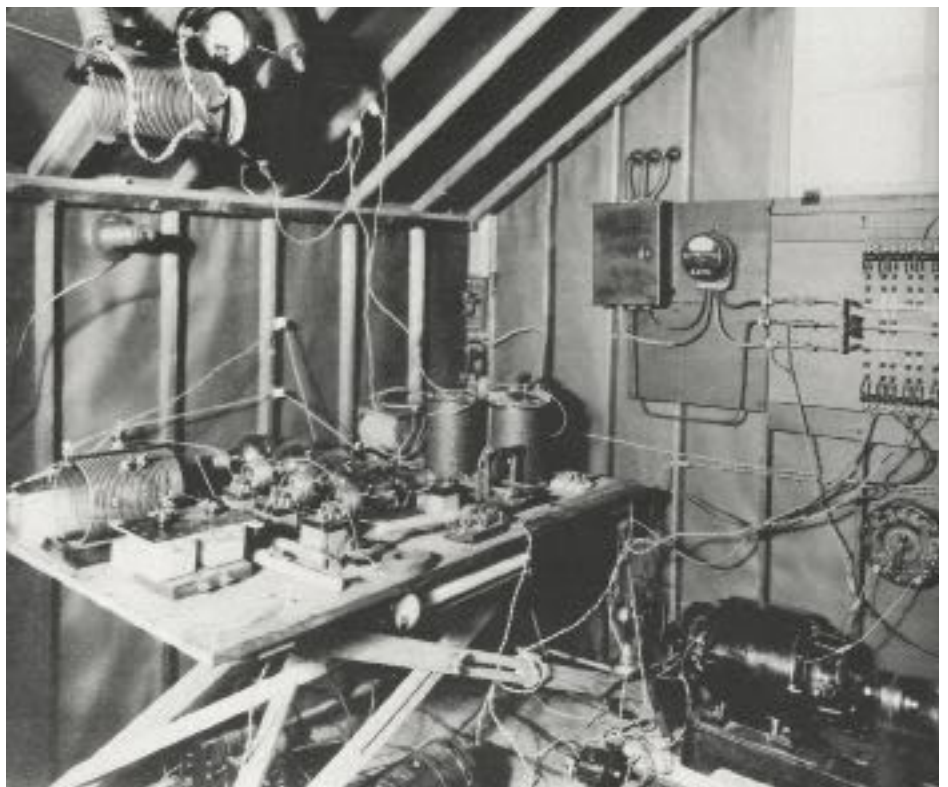

Station 1BCG in Connecticut had the most outstanding signal in Europe. The 1kW transmitter used three paralleled UV-204 Radiotrons in the PA, driven by a fourth as master oscillator. (ARRL).

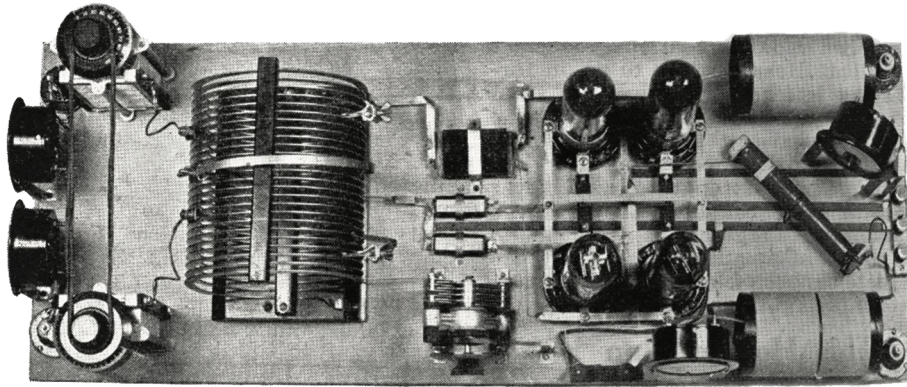

The transmitter at 1MO that was used by QST Editor Ken Warner for the first transatlantic US – UK QSO. (*Wireless World*).

troublesome than in London, although QRN levels were still high and there was strong interference from Clifden and a high-speed GPO transmitter in the north of Scotland. Tuning the Beverage involved adjusting the terminating resistor (at the far end, away from the tent), by struggling back and forth across the slimy seaweed in the darkness and driving rain. Despite these difficulties the transatlantic tests were entirely successful, with a total of 27 US and one Canadian station being identified.

At 7 every morning the commercial station MUU at Caernarfon transmitted the reception logs to the US, using hand-sent Morse at 12wpm so that amateurs could copy the signals directly. Marconi provided this service free of charge, although the ARRL is said to have rung up a message bill of \$1,900 [3]. Signals from the 1kW station 1BCG, which had been set up specially by Edwin Armstrong and other prominent amateurs in Connecticut, were so consistent that Godley asked Pearson to cable them to send real messages instead of just 'TEST'. But Pearson used the British abbreviation 'SEND MGES' instead of the American 'SEND MSGS', so the 1BCG operators misunderstood the request and transmitted the word 'MGES' all night long!

After returning to London, Godley spent ten hours in Coursey's office dictating his adventures. His account was subsequently published in *Wireless World* [4]. He received hearty congratulations from all the London crowd, but was also teased for having endured the bitter Scottish winter in a tent, while British amateurs had copied nine of the US stations in the warmth and comfort of their homes, using simpler home-built receivers with as few as three valves and their normal much shorter antennas. Perhaps as a result of the transatlantic tests, the Postmaster General relaxed the restriction on the length of receiving antennas from 4 May 1922.

East to west

Among the lessons learned from the 1921 tests were the superiority of CW to spark, the variability of propagation conditions (on one night signals were very strong, whereas on several nights none were received at all) and the fact that high power was not always necessary for DX communication on short waves. (Several US stations got across with less than 50W output). This augured well for the next phase in the transatlantic tests, which were organised for the winter of 1922. In this series, American and Canadian amateurs transmitted on the nights from 12 to 21 December, then listened out for European stations from 22 to 31 December.

During these tests 47 British amateurs reported receiving an average of 50 different North American stations per night, including a few on the Pacific coast and two in Canada. But US listeners were hampered by receivers lacking radio frequency amplifiers, by QRM from the large number of local amateurs

who didn't play the game and respect the reception periods, by harmonic interference from commercial stations and, initially, by misunderstanding of the schedule times, which had been listed in GMT! Although there were other unverified reports, the only confirmed European stations received in the US were 5WS from Wandsworth in South West London and 8AB from Nice in the South of France. 5WS was a station that had been set up by the RSGB especially for the tests and it had been granted a special 1kW permit by the GPO [5]. It was received by ten amateurs in the US, as well as in other countries – including an SWL with a one-way set in Reykjavik.

In retrospect, it seems surprising that the operators of 5WS made no attempt to make two-way contact with the US stations that reported they were receiving their messages. But 5WS stuck rigidly to the prescribed schedule of separate 10-day periods for transmitting and receiving and so missed the opportunity to achieve the first transatlantic QSO. That had to await the next series of tests a year later.

100 metres

As a result of the interference problem during the third tests, the initial emphasis during the fourth series was to be on improving US station operating discipline, to allow more European stations to be received. But it was planned that after the period from 22 December 1923 to 10 January 1924, which was reserved for separate transmitting by amateurs on either side of the Atlantic, two-way contacts would be attempted from 11 January. However, enthusiasm on both sides was riding high and in the

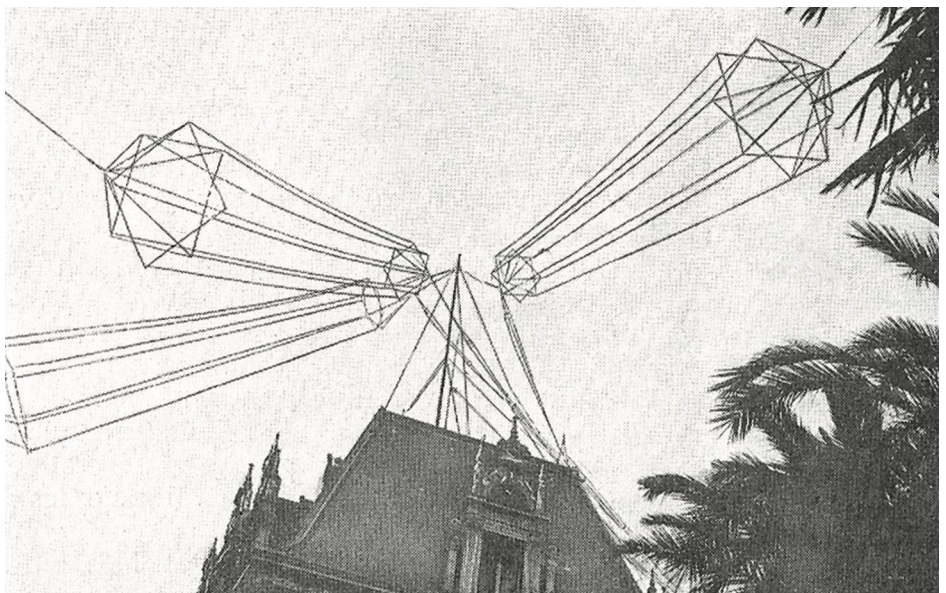

Léon Deloy, 8AB, in Nice used this antenna for the first two-way QSO between Europe and North America. The top of the mast is 105ft agl, and at their far end the cages are 12ft in diameter. (*ARRL*).

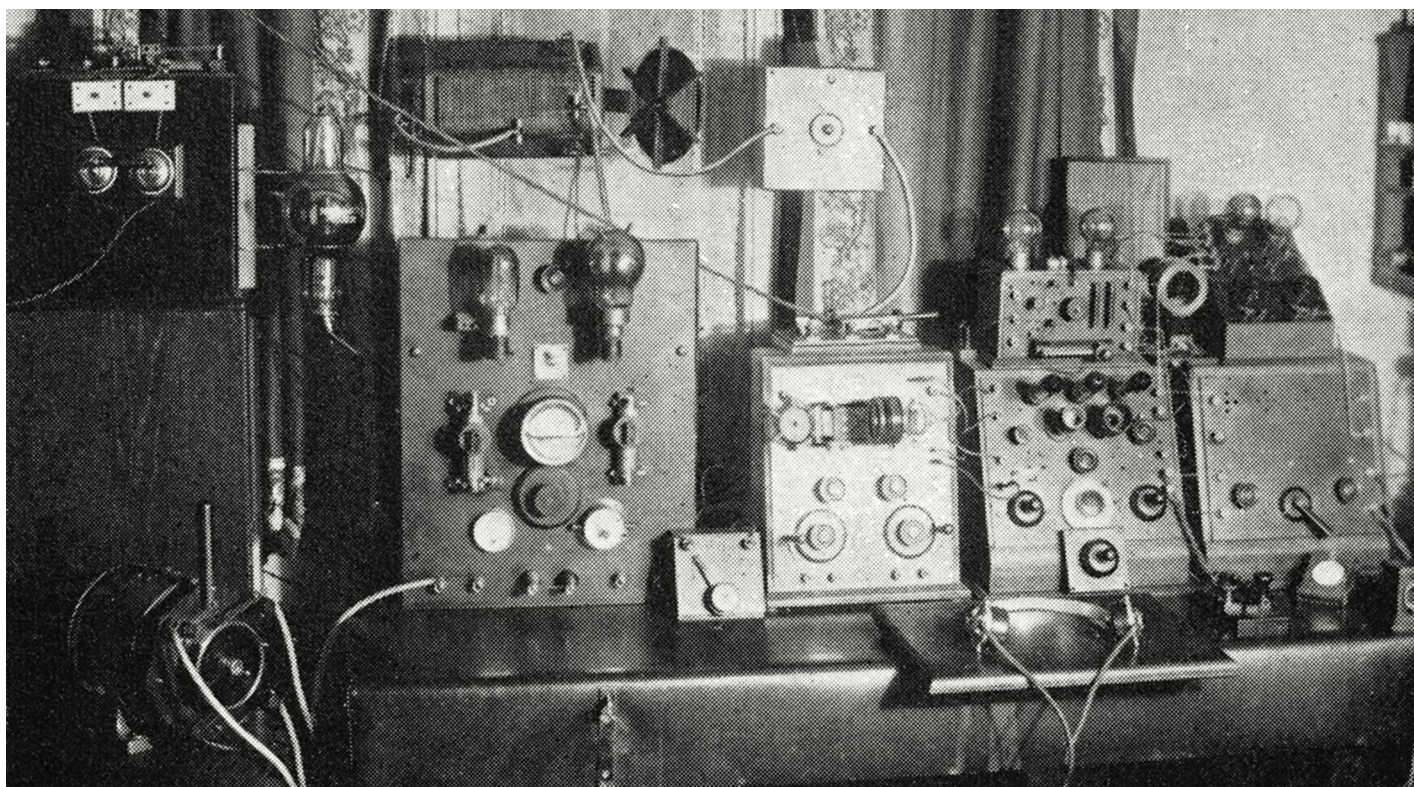

Running only 30W, Ernest Simmonds, 2OD, of Gerrards Cross made the first UK - Canada QSO with 1BQ in Halifax. (RSGB).

event French amateur Léon Deloy, 8AB and ARRL traffic manager Fred Schnell at 1MO jumped the gun on 28 November, moved down from 200 to 100 metres and achieved the first historic transatlantic QSO. At the time little was understood about short wave propagation, since Edward Appleton's ionospheric research wasn't published until 1925. Hence the success on 100 metres came as an unexpected surprise. It was initially attributed just to lower QRM or higher antenna efficiency.

Other amateurs soon joined in the fun, and Jack Partridge, 2KF in London achieved the first UK – US contact with a long QSO with Ken Warner at 1MO on 8 December. 1MO had 400W input, 2KF somewhat less. Both amateurs were using simple receivers with one detector and one audio amplifier stage. On 12 December Frederick Hogg, 2SH, in London also worked 1MO. Four days later the first Canada – UK QSO was made between A W Greig, 1BQ of Halifax and Ernest Simmonds, 2OD of Gerrards Cross, running only 30W. Hugh Ryan, 5BV of Wimbledon worked 1BQ on 28 December, and 1XW the following day.

Throughout 1924 other intercontinental DX records followed in rapid succession. On 19 October 18 year-old Cecil Goyder [6] created a sensation by contacting Frank Bell, 4AA, in New Zealand from the Mill Hill School station, 2SZ, in London, a distance of over 19,000km. One result of the explosive growth of international working was the

general introduction of country prefixes (G for Great Britain, HB for Switzerland, etc), since it was found that several stations in different countries had the same callsigns. This prefix scheme had been proposed by Deloy, and it was officially approved by the GPO from March 1924 [7].

For amateurs in many countries operation on 100 metres was not actually legal, as even transmission on wavelengths between 200 and 150 metres required a special permit. 1MO received permission for 100 metres just prior to working 8AB, while the French authorities only authorised operation down to 90 metres from March 1924. GPO permits were so expensive and restrictive (operation only between 01h00 and 07h00 – and then for not more than 15 minutes per night) that few British amateurs even bothered to apply for them. But in the US, 80, 40, 20 and 5 metre amateur radio allocations were granted from 25 July 1924, opening the way for further experiment and discovery.

Revolution

Such was the media interest in the successful amateur transatlantic tests that during an interview with the *Times* Marconi felt obliged to declare that his huge high power long wave stations were still required, since on short waves “a reliable service could not be maintained under certain atmospheric conditions”. But by April 1924 he had been won over and recommended to the British

Cabinet committee studying the Donald report that the project to build expensive long wave transmitters for the Imperial Wireless Chain should be scrapped, with much lower power short wave stations being built instead [8]. This revolutionary change of plan was ratified by Parliament in August of that year and in October 1926 Marconi inaugurated the first commercial short wave transatlantic radio link, operating between Britain and Canada on 16.5 metres during the day and 32.2 metres at night. The move to short waves, pioneered by the radio amateur transatlantic tests three years earlier, was considered by many the greatest innovation in communication since 1897.

References

- [1] P R Jensen, *Early Radio*, Kangaroo Press, 1994, ISBN 9780864176073, p. 61
- [2] K Warner, Failure of the Transatlantic Tests, *QST*, May 1921, pp. 15-16
- [3] C B DeSoto, *200 Meters and Down*, ARRL, 1936, ISBN 9780872590014, p. 74
- [4] P F Godley, Transatlantic Tests, *Wireless World*, 21 January 1922, pp. 660-663
- [5] P R Coursey, 5WS, *Wireless World*, 17-31 March 1923, pp. 785-877
- [6] E Richards, *Centenary: 100 years of working for amateur radio*, RSGB, 2013, ISBN 9781905086894, pp. 10-11
- [7] J Clarricoats, *World at their Fingertips*, RSGB, 1967, ISBN 9780900612091, pp. 100-101
- [8] M Raboy, *Marconi*, Oxford University Press, 2016, ISBN 9780199313587, p. 483