

# Adding eScience Assets to the Data Web

Herbert Van de Sompel  
Los Alamos National  
Laboratory  
Los Alamos, NM USA  
herbertv@lanl.gov

Simeon Warner  
Cornell University  
Ithaca, NY USA  
simeon@cs.cornell.edu

Carl Lagoze  
Cornell University  
Ithaca, NY USA  
lagoze@cs.cornell.edu

Robert Sanderson  
University of Liverpool  
Liverpool, UK  
azaroth@liv.ac.uk

Michael L. Nelson  
Old Dominion University  
Norfolk, VA USA  
mln@cs.odu.edu

Pete Johnston  
Eduserv Foundation  
Bath UK  
pete.johnston@eduserv.org.uk

## ABSTRACT

Aggregations of Web resources are increasingly important in scholarship as it adopts new methods that are data-centric, collaborative, and networked-based. The same notion of aggregations of resources is common to the mashed-up, socially networked information environment of Web 2.0. We present a mechanism to identify and describe aggregations of Web resources that has resulted from the Open Archives Initiative - Object Reuse and Exchange (OAI-ORE) project. The OAI-ORE specifications are based on the principles of the Architecture of the World Wide Web, the Semantic Web, and the Linked Data effort. Therefore, their incorporation into the cyberinfrastructure that supports eScholarship will ensure the integration of the products of scholarly research into the Data Web.

## Categories and Subject Descriptors

H.5.4 [Information Systems]: Hypertext/Hypermedia

## General Terms

Design, Standardization

## Keywords

Cyberinfrastructure, eScience, OAI-ORE, Web Architecture, Linked Data, RDF, Atom

## 1. INTRODUCTION

The rapid evolution of computing, networking, and data capturing technologies, along with advances in data mining and analysis, are fundamentally changing the way scholarly research is conducted [2, 5]. Although there are differences amongst disciplines in their receptivity to change [13], an increasing number of scholars in the natural sciences, social sciences, and humanities have adopted new research methods that are network-based, highly collaborative, and data-intensive. Because of the central role of vast amounts of data in these new research methods, there has been increased attention to sustainable infrastructures for registering, preserving, and sharing datasets [17].

In parallel with this change in research methodology there has been substantial change in the way that research results are communicated. With the emergence of the Web, scholarly publishers, both commercial and learned societies, almost universally deliver journal papers, conference proceedings, and monographs via the Web. While Web delivery of research results has improved their accessibility and searchability, it represents an evolution of traditional publication practices rather than a fundamental change in the scholarly communication paradigm. Even in their digital manifestations, scholarly publications are mostly textually-based and static. To date, there are few examples of scholarly communication that move beyond the dissemination of these traditional artifacts into a more data-centric, semantically-linked, and social network-embedded scholarly communication model that resembles the profound changes in social, political, and economic discourse characteristic of Web 2.0. This radically different model would expose process as well as product [39], improving opportunities to verify the reproducibility of research results, and making the full spectrum of artifacts generated in the scholarly value chain available for reuse [41].

The deployment of radically new models depends on the development of basic technical infrastructure, so-called cyberinfrastructure. This cyberinfrastructure must include a number of components. These include a means to identify and cite datasets in the scholarly discourse (e.g., [38, 1]), a standard for identifying scholarly authors to unambiguously tie them to their creations and improve the quality of scientometric information (e.g., ResearcherID<sup>1</sup> and Digital Author Identifier<sup>2</sup>), and standards to allow machine readability of the products of scholarly process thereby facilitating computational analysis and extraction of secondary and tertiary knowledge products. Semantic technologies are an important component of this cyberinfrastructure, providing a foundation for open agreements on data formats, metadata frameworks to describe data, and ontology-based solutions for formal representation of scientific knowledge, all of which are important components of promoting a machine-readable scholarly record.

This paper focuses on one aspect of this cyberinfrastructure

<sup>1</sup><http://www.researcherid.com/>

<sup>2</sup><http://www.surffoundation.nl/smartsite.dws?ch=eng&id=13480>

ture that arises from the changing nature of publications that are characteristic of collaborative, data-centric scholarship. These emerging publications are *aggregations* of multiple resources. Such aggregations are already prevalent in existing scholarly repositories, which commonly offer access to textual documents in multiple formats, each available from a different network location. But, the changes in scholarship described above, and especially the need to include data in the publication process, increases the complexity of these aggregations and calls for the adoption of a common approach to handle them. In the remainder of this paper, we describe our work within Open Archives Initiative - Object Reuse and Exchange (OAI-ORE), a two-year project to investigate common methods to handle aggregations of Web resources that culminated in October 2008 with the release of the OAI-ORE specifications [28]. These specifications were motivated by the resource aggregations common to scholarly communication. We believe that their generic, Web-centric approach makes them applicable to use cases in the Web at large, providing the basis for improved search results, improved information navigation, and richer services within browsers for a large class of Web applications.

The OAI-ORE specifications leverage the principles of the Architecture of the World Wide Web, the Semantic Web, and the Linked Data effort. As a result, future developments in cyberinfrastructure and scholarly communication that are based on OAI-ORE will integrate well with the Web and with the tools, agents and applications that operate within it. This will make it possible to embed or mash up the products of scholarship into cyber-learning efforts, cooperative reference tools such as Wikipedia, and the larger social discourse that is now characteristic of Web 2.0. The essence of the OAI-ORE solution to the resource aggregation problem can be summarized as follows:

- The data model is expressed in terms of the primitives of Web Architecture and the Semantic Web: Resources, Representations, URIs and RDF triples.
- The central entity in the data model, the Aggregation, is a Resource that stands for a set of other Resources. An Aggregation is a Resource with a URI but without a Representation (we refer to this as a non-document Resource from now on). This approach is aligned with the manner in which real-world entities or concepts are included in the Web via the mechanisms proposed by the Linked Data effort [4].
- Another Resource, the Resource Map, has a Representation that is a description of the Aggregation. The Resource Map is accessible via the URI of the Aggregation using the mechanisms defined for Cool URIs for the Semantic Web [36].
- The Representation of a Resource Map is a serialization of the triples that describe the Aggregation. The specification describes RDF/XML, RDFa, and Atom serialization syntaxes.

## 2. AGGREGATIONS

### 2.1 Aggregations in Scholarly Communication

Most institutional repositories [24, 31] routinely store and disseminate relatively simple aggregations, consisting of multiple access formats (e.g., PDF, HTML, LaTeX) for the same

document. In addition, prototypes exist of applications that allow authoring, storing, and disseminating more complex scholarly publications in the form of aggregations [8, 33, 42]. These more complex aggregations may consist of a textual article, one or more datasets that led to the discoveries reported in the article, perhaps a visualization of a specific state of the dataset, and the software used to generate the visualization. All constituents of such an aggregation are distributed on the Web. One notable aspect of these more complex visions of an aggregate scholarly publication is the importance of semantic relationships among constituents of the aggregation. These relationships include citation, versioning, provenance, commentary, and the like.

Some characteristics of the aggregations that are already common in scholarship can be illustrated by means of a document from [arXiv.org](http://arxiv.org), a well-known repository of physics, mathematics, and computer science research results. The human start page, or “splash page”, for this document is shown in Figure 1. Some aspects of the page relevant to the resource aggregation problem are highlighted in red rectangles, each with a number. The meanings of the highlighted areas are as follows:

1. The URI <http://arxiv.org/abs/astro-ph/0601007> of the human start page for the arXiv document.
2. The formats in which the document is available, i.e. PostScript, PDF, etc. These are effectively the constituents of the aggregation that is the arXiv document.
3. The title of the arXiv document.
4. The authors of the arXiv document.
5. The creation and last modification date of the arXiv document.
6. Identifiers of resources that are in some manner comparable to this arXiv document. For example, a version of this document was later published as an article in a peer-reviewed journal, and the Digital Object Identifier of that article is shown.
7. The versions of this arXiv document.
8. Links to other arXiv documents in the same collection (i.e., astro-ph).
9. Citations made by this arXiv document, and citations it received from other documents.

This rather simple example highlights the core issues that OAI-ORE addresses. First, although the URI of the human start page is commonly used as the URI for the entire arXiv document, within the Web Architecture that URI only identifies the page itself, and not the aggregation that is the arXiv document. The ability to cite, annotate, version, and associate properties with the aggregation itself relies on it having a unique identity, distinct from the splash page or the resources linked from it.

Second, without the use of (frequently imperfect) heuristics unique to the specific human start page, it is not readable by machines and agents. Because the HTML of this human start page usually leaves the semantics of hyperlinks undefined, a machine agent cannot unambiguously distinguish between links to constituents (e.g. the PostScript,

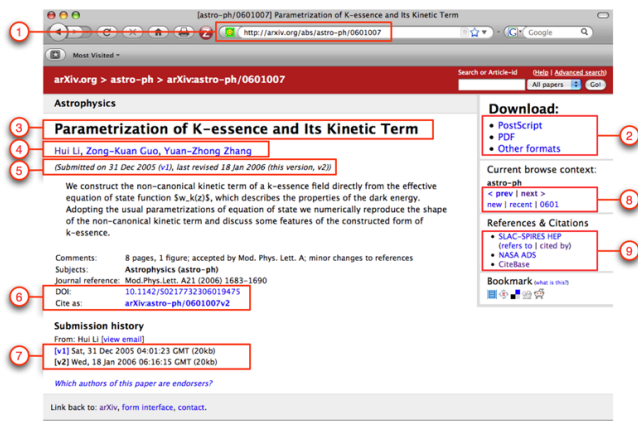

Figure 1: The implicitly defined members of a scholarly aggregation.

PDF, etc.) of the document and links that point at information that is clearly outside of the document such as the navigational aids shown as (8) in Figure 1. Similarly, agents can not interpret relationships of the document to other documents, identifiers related to this document, versions of this document, etc.

In essence, the problem is that there is no standard way to describe the constituents or boundary of an aggregation, or to qualify and identify a resource as being an aggregation. While a robot could learn the semantics implied by arXiv's HTML in Figure 1, such "screen scraping" is brittle and not scalable for applications accessing aggregations in thousands of different repositories, each with their own presentation idiom.

## 2.2 Integrating Aggregations into the Web

A number of early efforts in cyberinfrastructure, for example the initial grid architecture [40] and technologies for digital libraries, leveraged aspects of the Web infrastructure but often failed to fully conform with Web Architecture principles. For example, institutional repositories frequently have identifier schemes and access protocols distinct from those existing on the Web at large. As a result, much of their content is accessible on the Web, but it poorly integrates with mainstream Web applications and may even be overlooked by major search engines, unless the search engines make special accommodations for their protocols and access schemes.

Our prior work on the Open Archives Initiative Protocol For Metadata Harvesting (OAI-PMH) [26] demonstrates this problem. OAI-PMH is an interoperability specification released in 2001 aimed at streamlining the process of incrementally collecting XML metadata (typically bibliographic metadata) from information systems. It shares many design characteristics with Atom [35] and is widely adopted in its targeted community of scholarly repositories. But, OAI-PMH, in contrast to Atom, has not gained broader adoption, mainly because its architecture is not well aligned with the Resource/URI/Representation foundations of the Web Architecture. For example, OAI-PMH clients must construct a request URI by combining a repository specific base URI, the identifier of the item of interest, and a format tag in an

OAI-PMH specific manner, often preventing general Web clients that are unaware of the protocol from accessing the available metadata [19].

The Web-centric, resource-centric approach of OAI-ORE rectifies this architectural shortcoming and thereby provides the foundation for full accessibility of the products of eScience in the general Web environment. Furthermore, it makes the solution available to a broader class of Web applications in which the practice of aggregating resources is quite common. For example, we accumulate URLs in bookmarks or favorites lists in our browser, collect photos into sets in popular sites like Flickr, browse over multiple page documents that are linked together through "prev" and "next" tags, and talk about Web sites as if they had some real existence beyond the set of pages of which they consist. Despite our frequent use of these aggregations, their existence on the Web is quite ephemeral because there is no common way to identify, describe, and hence handle them. This is what OAI-ORE provides.

## 3. THE OAI-ORE SOLUTION

In this section we describe the various elements of the OAI-ORE solution to the resource aggregation problem outlined above. It encompasses an RDF-based data model, syntaxes for serializing instances of the data model, and mechanisms for providing HTTP access to those serializations. Complete details are available through the OAI-ORE documentation suite [28].

As noted earlier, this solution is based on the primitives defined in the Architecture of the World Wide Web [23] that defines a Resource as an item of interest; a URI as a global identifier for a Resource; and a Representation as a datastream corresponding to the state of a Resource at the time its URI is dereferenced via some protocol (e.g. HTTP). In addition, the solution is grounded in the principles introduced by the Semantic Web, in which URIs are also used to identify non-document Resources, such as real-world entities (e.g. people or cars), or even abstract entities (e.g. ideas or classes). These non-document Resources have no Representation to indicate their meaning. OAI-ORE adopts the following approach, proposed by the Linked Data effort [4], for obtaining information about those Resources:

- Use of HTTP URIs to identify those non-document Resources;
- Publication of another Resource with a Representation that provides information about the non-document Resource at a HTTP URI other than the HTTP URI of the non-document Resource;
- Leverage of HTTP mechanisms to allow discovery of the HTTP URI of the published resource from the HTTP URI of the non-document resource.

### 3.1 Data Model

The essence of the RDF-based data model is described here and is illustrated in Figure 2. The full details are available in the OAI-ORE Abstract Data Model specification [27].

In order to be able to unambiguously refer to an aggregation of Web resources, a new Resource is introduced that stands for a set or collection of other Resources. This new Resource, named an *Aggregation*, has a URI just like any

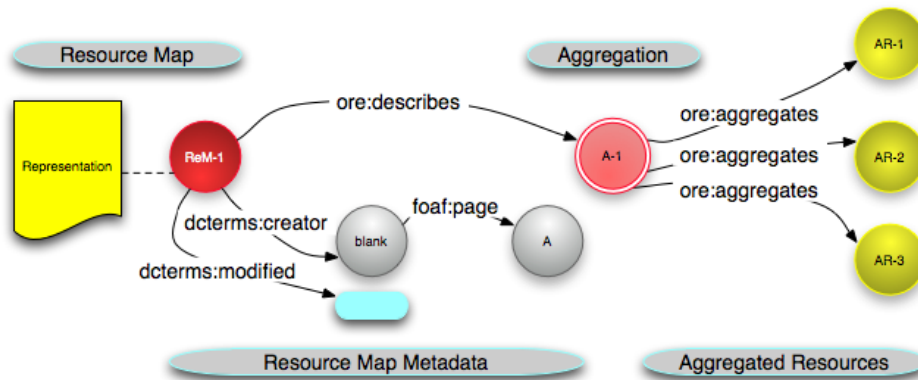

Figure 2: A Resource Map describes an Aggregation with three Aggregated Resources.

other Resource on the Web. And, since an Aggregation is a conceptual construct, it is a non-document Resource that does not have a Representation.

Following the Linked Data guidelines, another Resource is introduced to make information about the Aggregation available. This new Resource, named a *Resource Map*, has a URI and a machine-readable Representation that provides details about the Aggregation. In essence, a Resource Map expresses which Aggregation it describes (the `ore:describes` relationship in Figure 2), and it lists the *Aggregated Resources* that are part of the Aggregation (the `ore:aggregates` relationship in Figure 2, a subproperty of `dcterms:hasPart`). But, a Resource Map can also express relationships and properties pertaining to all these Resources, as well as metadata pertaining to the Resource Map itself, e.g. who published it and when it was most recently modified (the `dcterms:creator` and `dcterms:modified` relationships in Figure 2). A Resource Map can also express relationships of the Aggregation, Aggregated Resources, and the Resource Map itself with any arbitrary other Resource, as long as the resulting RDF graph is connected.

In addition, for discovery purposes, the data model allows a Resource Map to express that an Aggregated Resource of a specific Aggregation is also part of another Aggregation. This is achieved by means of the `ore:isAggregatedBy` relationship (the inverse of `ore:aggregates`) between the Aggregated Resource and that other Aggregation. Also stating that an Aggregated Resource is itself an Aggregation (nesting Aggregations) is supported. To that purpose, an `ore:isDescribedBy` relationship (the inverse of `ore:describes`, and a subproperty of `rdfs:seeAlso`) is expressed between the Aggregated Resource and a Resource Map that describes it as being itself an Aggregation. Furthermore, the use of non-protocol-based identifiers (such as DOIs) that can be expressed as URIs is quite common for referencing scholarly assets. In order to support this practice, the `ore:similarTo` relationship between an Aggregation and a somehow equivalent resource identified by a non-protocol-based URI is expressed. The specificity of `ore:similarTo` is situated between `rdfs:seeAlso` and `owl:sameAs`.

### 3.2 Proxies: Aggregated Resources in Context

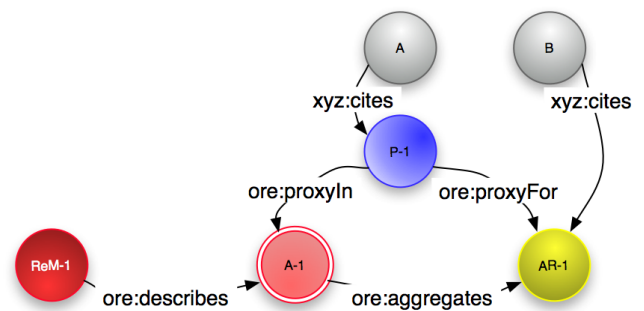

Figure 3: Citing a Resource in the context of an Aggregation.

We note that the URI asserted in a Resource Map to denote an Aggregated Resource of a particular Aggregation is no different than the URI that denotes that Resource independent of the Aggregation. However, it is important in scholarly communication, among others for the purpose of citing and expressing provenance, that a resource such as a dataset included in some context, for example a specific article, be distinct from the same dataset outside the context of that article, or in the context of another article.

To accomplish this differentiation, OAI-ORE introduces the notion of a *Proxy*. A Proxy is a Resource that stands for an Aggregated Resource in the context of a specific Aggregation. The URI of a Proxy provides a mechanism for denoting a Resource in context. Figure 3 shows the `ore:ProxyFor` and `ore:ProxyIn` relationships between a Proxy and an Aggregated Resource and an Aggregation, respectively. It also illustrates how citing the Aggregated Resource is different from citing its Proxy: the former cites a Resource “as is”, the latter cites that Resource as it exists in the context of a specific Aggregation. In order to work seamlessly in the Web and to provide context information to OAI-ORE aware clients, resolution of HTTP URIs assigned to Proxies must lead to the Aggregated Resource, and the response must include a HTTP Link Header [34] that points to the Aggregation.

### 3.3 Resource Map Serializations

A Resource Map has a Representation that describes an Aggregation in some serialization syntax. OAI-ORE explicitly specifies three serialization syntaxes, Atom XML, RDF/XML, and RDFa, while other serialization syntaxes are possible. Which one to choose will largely depend on the use case and on the technical environment available to a Resource Map publisher. For example, in cases where an expressive HTML splash page exists an RDFa approach might be attractive. Note that multiple Resource Maps, each using a different serialization syntax can describe the same Aggregation, and that these may differ in expressiveness<sup>3</sup>.

Although the data model is based on RDF, we were committed to also specify a serialization based on Atom, to allow Aggregations to become the subject of Web 2.0 reuse scenarios and of workflows based on the Atom Publishing Protocol [18]. The Atom Publishing Protocol adds a uniform read/write approach to Web 2.0, which could be of significant benefit in scholarly communication scenarios.

However, the task of reconciling the data model with the Atom model proved to be non-trivial due to tensions between the RDF model and the XML-oriented Atom specification. The former is graph-based, with precise semantics that are global rather than local to a specific document. The latter is hierarchical, (XML) document-centric, and has intentionally loose element definitions. It took several, dramatically different iterations of the Atom serialization to arrive at an acceptable solution.

The resulting approach expresses an Aggregation by means of an Atom `entry`, and makes use of Atom's extensibility mechanisms in much the same way as Google Data does. For example, Atom's `link` element with an OAI-ORE-specific value for the `rel` attribute is used to aggregate resources. And, awaiting a solution from the Atom community to deal express triples, an `ore:triples` element was introduced to act as a wrapper for RDF descriptions. To support unambiguous interpretation of Atom serializations of Resource Maps, a GRDDL transform was implemented that extracts all contained triples that pertain to the OAI-ORE data model, both from the native Atom elements and from the `ore:triples` extension element, and expresses them in RDF/XML<sup>4</sup>.

### 3.4 Leveraging HTTP

In order to make OAI-ORE work in the HTTP-based Web, both the Aggregation and the Resource Map are assigned HTTP URIs, and the Cool URIs for the Semantic Web guidelines [36] are adopted to support discovery of the HTTP URI of a Resource Map given the HTTP URI of an Aggregation. Figure 4 illustrates a situation in which the arXiv Aggregation is described by both an Atom XML and an RDF/XML Resource Map, and in which a client is led to the Atom version via an HTTP 303 redirect and Content Negotiation.

### 3.5 Authoritative Resource Maps

After one party has published a Resource Map that contains a description and a URI for a new Aggregation, any other party can publish competing or even conflicting Resource Maps that describe the same Aggregation. To ad-

<sup>3</sup>See <http://www.openarchives.org/ore/atom> for detailed Atom and RDF/XML versions of Resources Maps corresponding to Figure 1.

<sup>4</sup><http://www.openarchives.org/ore/atom-grddl>

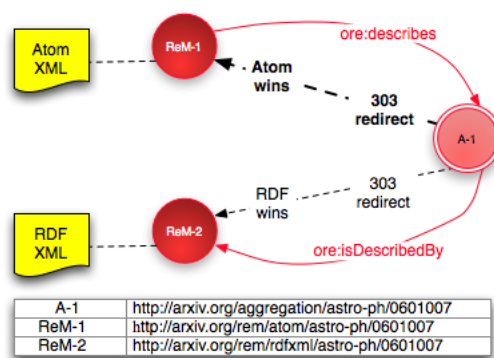

Figure 4: Discovering a Resource Map from an Aggregation using Cool URIs for the Semantic Web.

dress this we distinguish between Authoritative and Non-Authoritative Resource Maps in the same way as the Linked Data guidelines. An Authoritative Resource Map is one that is accessible by dereferencing the URI of the Aggregation that it describes, for example using the aforementioned Cool URI mechanisms. A Non-Authoritative Resource Map is one not reachable in this manner. The rationale for this approach is that the party that introduces a new Aggregation simultaneously mints URIs for both the Aggregation and the Resource Map, and actually controls both.

## 4. EARLY DEMONSTRATORS

Since the OAI-ORE specifications have only been released recently, an in-depth evaluation of functionality, adoption, and impact is premature. Still, in this section we give an insight in efforts by early adopters to leverage the specifications. Four use cases are described below. Additional illustrations of its application are provided by the submissions to the ORE Challenge at RepoCamp 2008<sup>5</sup>.

### 4.1 Foresite: Revealing Aggregations

In order to provide feedback on the evolving OAI-ORE specification, the UK's Joint Information Systems Committee (JISC)<sup>6</sup> funded an experiment to investigate applying it to an extensive scholarly collection: the approximately four million articles that are part of the JSTOR<sup>7</sup> collection. By developing open source OAI-ORE libraries<sup>8</sup> and applying them to produce interlinked Resource Maps, the Foresite project effectively demonstrated the feasibility of exposing common scholarly artifacts to the Data Web in the manner proposed by OAI-ORE. The project provided valuable feedback that helped refine the OAI-ORE specifications, and had a significant impact on the aforementioned discussions regarding the Atom serialization of Resource Maps.

The overall structure of the Aggregations, and associated Resource Maps, produced for the JSTOR collection mirrors the journal - issue - article hierarchy of the JSTOR content. Each journal is modeled as an Aggregation of journal issues;

<sup>5</sup><http://www.openarchives.org/ore/RepoCamp2008/>

<sup>6</sup><http://www.jisc.ac.uk/>

<sup>7</sup><http://www.jstor.org/>

<sup>8</sup><http://foresite-toolkit.googlecode.com/>



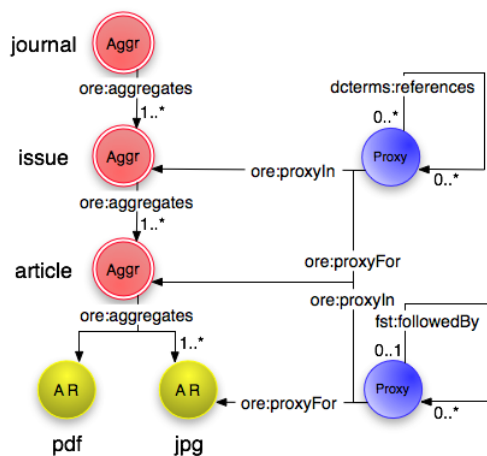

Figure 5: The hierarchical structure of the JSTOR collection mapped to the OAI-ORE data model. Note that 1..1 cardinalities are omitted from the diagram for clarity.

each issue is an Aggregation of articles; and each article is an Aggregation of individual page images and a PDF-formatted version of the entire article (Figure 5). The Aggregated Resources at each level are also the subject and/or object of a `fst:followedBy` relationship introduced to preserve the page-turning order for pages within an article, articles within an issue and so forth. Because `fst:followedBy` is not a global relationship, but rather only applies within the context of a specific Aggregation, Proxies for these Aggregated Resources were introduced. The article Aggregations interlink via `dcterms:references` relationships for citations, further confirming the necessity of the graph-based nature of the OAI-ORE data model, even though the main JSTOR content hierarchy is tree-shaped. The Resource Maps were published on a Web server at the University of Liverpool.

The resulting OAI-ORE descriptions are of immediate business importance to JSTOR. While JSTOR stores the OCR-ed full-text of each article, it is only able to openly expose this kind of topological metadata, and would lose its market advantage (and the participation of contributing publishers) if the full-text were exposed. Having the topology of their collection available in a standardized format that provides links back to their protected full-text documents and images, facilitates reuse in third party applications that can help drive traffic to the JSTOR site and increase its customer base.

In order to provide a value-added service on the basis of the generated Resource Maps without requiring JSTOR to integrate prototype code into their production portal, the Foresite Explorer – a visualization application<sup>9</sup>, was developed using GreaseMonkey<sup>10</sup> and its cross-site capable XmlHttpRequest. This one-click-install plug-in for Firefox<sup>11</sup> extracts the URI of the resource that is currently being viewed in the JSTOR Web interface and retrieves the associated RDF/XML Resource Map that describes the Aggregation

<sup>9</sup><http://foresite.cheshire3.org/explorer/>

<sup>10</sup><http://www.greasespot.net/>

<sup>11</sup><http://www.mozilla.com/firefox/>

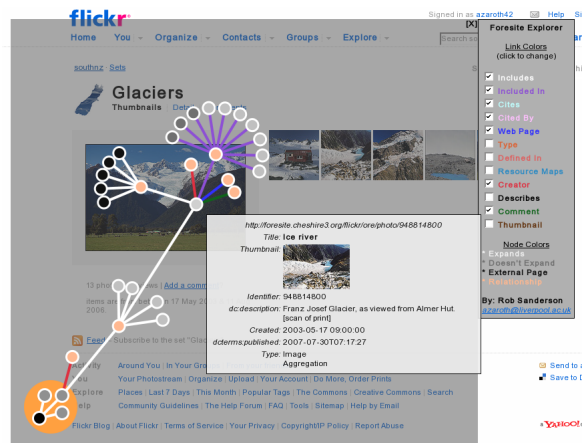

Figure 6: The Foresite plug-in models Flickr Sets as OAI-ORE Aggregations, and visualizes them.

to which the Web resource corresponds from the Liverpool Web server. The plug-in then parses and displays the Resource Map graph via dynamic SVG. Nodes in the display represent Aggregations, Aggregated Resources, and related Resources. Nodes for Aggregations can be clicked to expand or contract the visualization; in case of expansion, new Resource Maps are obtained, parsed, and again visualized.

Further experiments using the same approach were carried out on mainstream Web portals, leveraging the provided Web service APIs to obtain metadata, and to express it according to the ORE data model. Flickr<sup>12</sup> and Amazon<sup>13</sup> were selected, and wrapper services were built to generate Resource Maps on demand through REST interactions, and to publish them on the Liverpool server. Flickr provides a rich dataset with photos, photo sets, users, groups, favorites and even comments and tags that can all be modeled as Aggregations. Figure 6 shows a visualization of the structure of the Flickr Set “Glaciers” that consists of five photographs. In the Foresite Explorer, this set is represented with an Aggregation visualized as the top right node within the OAI-ORE logo (left bottom of Figure 6), emitting a red `dcterms:creator` arc and a white `ore:aggregates` arc. The latter leads to the five photographs. The third photograph is selected, and another white `ore:aggregates` arc reaches out to the available image files (differing image resolutions) represented as black nodes. The purple nodes indicate other aggregations in which the selected photo is aggregated.

Amazon offers fewer constructs that readily map to the OAI-ORE data model, but the user wishlists is a compelling one. The mapping to the data model is as follows: a wishlist becomes an Aggregation, and wished-for items become Aggregated Resources. Interestingly, each item in an Amazon wishlist has a unique identifier by which it is purchased. That identifier is only valid within that specific wishlist to allow tracking of individual items, once purchased. These wishlist specific constructs map directly the Proxies of the OAI-ORE model. The GreaseMonkey script was updated to discover these identifiers that are necessary to interact with the Amazon Web services, and Proxy-based relationships

<sup>12</sup><http://www.flickr.com/>

<sup>13</sup><http://www.amazon.com/>

were added to the visualization.

Overall, the Foresite experiment has illustrated the applicability of the OAI-ORE resource aggregation model as well as the feasibility to leverage it to create a value-added service. It has demonstrated this for both common scholarly communication artifacts and specific constructs used by popular Web portals. The Foresite experiment will be described in more detail in a dedicated, future publication.

## 4.2 Astronomy Publication Workflow

Datasets are of fundamental importance in observational sciences such as astronomy. The astronomy community has developed sophisticated repositories and data standards, exemplified by the Sloan Digital Sky Survey<sup>14</sup> and the National Virtual Observatory<sup>15</sup>, which provide excellent facilities for registering and accessing large datasets. However, when submitting an article, both new datasets that were created to arrive at findings reported in an article, and data citation information that reveals the reuse of existing datasets are often lost, “left behind” on the personal computer of the author.

A team at Johns Hopkins University is collaborating with the American Astronomical Society to capture datasets as part of the publication workflow [9]. In the newly devised publication workflows, OAI-ORE Aggregations are used to glue an article and its associated datasets together, and Resource Maps that describe these Aggregations are the tokens that move around between author, publisher and dataset repository as the publication process proceeds [10]. At each stage of the publication workflow, the Resource Map is used to convey the current state of the Aggregation, and is then updated to reflect the new state that is then passed on to the next workflow phase. For example, as a Resource Map is passed from the publisher to the dataset repository and back again, it is updated to contain the URIs of datasets that are registered in the repository, and that were used for the article. This allows the publisher to link to the datasets that were used for a specific article, and the repository to link to papers that used a specific dataset.

Generally, the availability of these Aggregations enables new services to be built on both the publishing platform and the data repository. If the practices proposed by this novel publication workflow became commonplace, it would represent a significant improvement in the efficiency of scientific communication.

## 4.3 Authoring, Editing and Reusing

The success of OAI-ORE depends on the ease with which Aggregations and Resource Maps are authored and disseminated on the Web. In many cases, they will be generated automatically based on information that is available in an information system. For example, the [arXiv.org](http://arxiv.org) database contains all information that is necessary to automatically generate Aggregations and their associated Resource Maps, as shown in the Appendices. And, in the astronomy project described above, the ability to create Resource Maps is built into familiar authoring environments in a manner that makes it a side-effect of the authoring process and thus minimizes the burden on authors.

Like all cyberinfrastructure, the success of such authoring environments depends on the manner in which assembling

all resources that relate to a particular research task or publication fits into the normal scholarly workflow. Two authoring environments that demonstrate this are the Literature Object Reuse and Exchange (LORE) tool created by Gerber et al.<sup>16</sup>, and by the SCOPE work of Cheung et al. [8, 21]. LORE is a Firefox extension that communicates via Ajax with a Sesame2 data store for maintaining the OAI-ORE graphs that are generated. LORE allows for the generation of fine-grained metadata and relationships, for example, allowing indicating that a certain resource is contextual information about the literature work that is being studied. The SCOPE work led to the development of the Provenance Explorer, a stand-alone Java application with functionalities similar to those of LORE, but aimed at the creation, editing and publication of scientific compound objects.

## 4.4 Enhanced Publications

The Dutch SURFshare program<sup>17</sup> and the European DRIVER II project<sup>18</sup> are collaborating on cyberinfrastructure to join a multitude of scientific repositories that hold publications and research data. The goal is to give researchers better means to share and access scientific materials through innovative services. One of the envisioned services relates to *enhanced publications*, composites of textual publications and supporting resources such as research-data, visualizations, annotations, related websites, etc. To ensure the integrity and usability of such enhanced publications it is important that all its components and their interrelations are being preserved.

A study into object models suitable for the representation of enhanced publications recommended the use of OAI-ORE. As a result, a demonstrator project [20] was launched in which enhanced publications for multiple scientific disciplines ranging from engineering to journalism were modeled according to OAI-ORE, and in which approaches to meet a variety of requirements were explored, including presentation, navigation, persistent identification, granularity of referencing, handling of sequentially ordered resources, visualization of interrelationships, etc. The results are available at the project site<sup>19</sup>. The project chose RDF/XML to express Resource Maps and uses an XSLT-based approach to dynamically generate an HTML “splash page” from them. In each splash page, a *Content* tab (Figure 7) lists all crucial metadata about the enhanced publication, prominently shows its textual component and associated metadata, and neatly lists additional resources again with metadata. Many of these resources are themselves modeled as Aggregations, and hence also have their own splash page. To support an understanding of the relationships among resources of an Aggregation and of nested Aggregations, a *Relations* tab that loads a Java applet fueled by Resource Map content is introduced. Overall, the demonstrator is remarkable because of the elegance and simplicity of the ORE implementation. It clearly illustrates that ORE can be used as a basic model for enhanced publications, and points at the need for community-defined vocabularies to convey expressive relationships among scientific resources.

<sup>16</sup><http://www.openarchives.org/ore/RepoCamp2008/#LORE>

<sup>17</sup><http://www.surffoundation.nl/en/>

<sup>18</sup><http://www.driver-community.eu/>

<sup>19</sup><http://driver2.dans.knaw.nl/demonstrator/html/>

<sup>14</sup><http://www.sdss.org/>

<sup>15</sup><http://www.us-vo.org/>

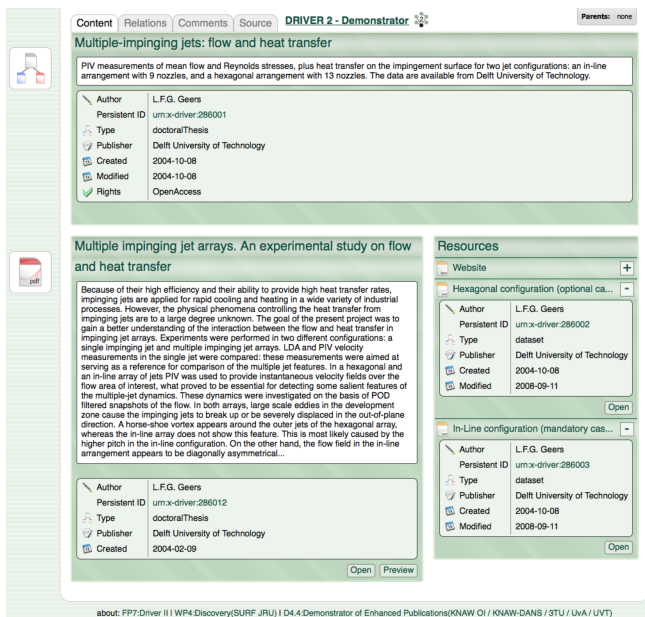

**Figure 7: The splash page for an enhanced publication of the DRIVER II project, dynamically rendered from an RDF/XML Resource Map.**

## 5. RELATED WORK

Given the widespread use of aggregations in both the physical and the Web world, it comes as no surprise that other efforts have investigated this domain. Prior work in the Web realm can be grouped in two main categories depending on the party that introduces aggregations. In one case, that is the Web navigator (agent or reader), in the other case it is the administrator of a Web-based information system. We look at a number of efforts in both categories, and evaluate their capabilities to identify aggregations, to enumerate the constituent resources of an aggregation, to express relationships among resources, and to accommodate resources that are distributed on the Web.

In the Web navigator case, either an interactive user groups resources based on some intent, or a robot tries to infer the implicitly defined members of an aggregation. The robotic approaches range from heuristics [30, 14] to machine-learning [12, 11]. While these approaches are useful, they are imperfect and dependent on the perception of those encoding the heuristics or training set and they do not necessarily reflect the intention of the original authors of the Web resources. And, while these approaches may succeed at selecting the distributed resources that are part of an implicitly defined aggregation, they are not capable of inferring the relationships between those resources, nor do they propose a way to unambiguously describe the aggregation.

The approaches that involve an interactive user include tools such as GroupMe!<sup>20</sup> and LinkBunch<sup>21</sup>. LinkBunch lets users submit several URIs that are then assigned a new HTTP URI that, when dereferenced, returns an HTML page that lists and links to the originally submitted URIs. The

“bunch” has a new HTTP URI identity, it enumerates its members, and it readily handles distributed Web resources. However, the identity of the bunch is the same as that of the HTML page that describes it, and expressing relationships between the bunched resources is not supported. GroupMe! is similar, with the addition of social tagging capabilities, but has the same problems as LinkBunch.

Some Web navigator approaches work in an opposite granular direction, supporting *disaggregation* of a single Web resource (i.e., an HTML page) into multiple resources. This can be done automatically, such as for segmented display on limited devices such as PDAs [7] or for recovering structured records from Web pages [15]. Decomposition can also be done manually, such as for reuse and sharing of parts of a Web page (e.g., ClipMarks<sup>22</sup>). All these approaches, manually or automatically, can be thought of as adding (or inferring) HTML anchors where none exist. These approaches assign identities to the newly created resources (fragments of the original resource), but they provide no approach to describe the original resource as an aggregation of these new resources, nor do they allow expressing relationships among them.

In approaches that have the administrator of a Web information system in the driver seat, several technologies exist to deal with resource aggregations. Sitemaps were briefly considered as a serialization option for Resource Maps. Google, Yahoo and Microsoft support the Sitemap Protocol [16], a simple XML file format that allows Web sites to list the URIs they want crawled by robots. Sitemaps provide for minimal metadata (e.g., last modification date, update frequency and crawl priority), but no attempt is made to provide semantic typing, and handling arbitrary distributed resources is not supported. Indeed, in the interest of trust, the Sitemap Protocol specifies a significant limitation on URI paths that can be listed in a Sitemap file. For example, a Sitemap at level `www.foo.com/a/b` can list URIs at level `a/b` and below, but it cannot list URIs at `www.foo.com/a/c`, `www.foo.com/d/` or `www.bar.com/`.

We made a deliberate decision to avoid the many existing packaging formats, such as MPEG-21 DIDL [3], METS [32], FOXML [25], IMS-CP [22], and BagIt [6]. First, packaging base64-encoded content in a wrapper document does not resonate well with the Resource/URI/Representation paradigm of the Web Architecture. Still, most of these formats also support a by-reference mechanism to deliver content, in which URIs can be used. However, although these formats are prominent in their respective communities, they have not gained an adoption comparable to that of Atom or RDF/XML. And while these approaches can address identification, and enumeration of distributed resources, they have uneven capabilities to express the graph-based OAI-ORE model, due to their hierarchical perspective.

In the course of the OAI-ORE effort, we also attempted to model aggregations as Atom feeds, not entries [29]. We ultimately decided that was the wrong granularity, especially since common Web 2.0 reuse scenarios, including use with the Atom Publishing Protocol, work at the level of Atom entries. The Atom Syndication Format was preferred over the various RSS formats in anticipation of using the Atom Publishing Protocol [18].

Some elements of the POWDER [37] specifications that

<sup>20</sup><http://groupme.org/>

<sup>21</sup><http://linkbun.ch/>

<sup>22</sup><http://clipmarks.com/>



were developed in the same timeframe as OAI-ORE address a problem space similar to that of OAI-ORE. However, POWDER's focus is significantly broader, and it approaches the problem from the opposite perspective,

focusing on capabilities to assert (via "Description Resources") that a group of resources share certain properties (e.g. access rights), rather than asserting arbitrary properties about resources that, for some reason, are grouped into an aggregation. That is, in POWDER the notion of shared properties defines an aggregation, whereas in OAI-ORE an aggregation can be created for any reason deemed important by its creator. Also, while POWDER provides capabilities to describe a group of resources using a variety of approaches including regular expressions, it does not introduce an identity for the aggregation.

## 6. CONCLUSIONS

This paper has introduced the OAI-ORE solution to the resource aggregation problem, which we argue meets a critical need in the development of cyberinfrastructure and the next generation scholarly communication infrastructure. By aligning the solution with the Web Architecture, and by leveraging the practices of the Semantic Web and Linked Data effort, it will facilitate better integration of scholarly communication with the mainstream Web, it will make scholarly artifacts more readily usable with common Web tools and applications, and it will benefit the broader community by making research materials more visible, verifiable, and by facilitating unexpected reuse.

While OAI-ORE was motivated by scholarly communication, we believe that the proposed solution has broader applicability. Aggregations, sets, and collections are as common on the Web as they are in the everyday physical world. In many situations it would benefit agents and services if aggregations were unambiguously enumerated and described, essentially layering an addition level of resource granularity upon the Web.

Evaluation of the OAI-ORE work depends on its adoption and evolution over time. The work has so far benefited from significant community involvement throughout the specification process, and the international team that developed the solution includes representatives with backgrounds in scholarly publishing, eScience, repository infrastructure, digital libraries, Web search engines, linked data, and information interoperability. Work by early adopters, such as the Foresite project and John's Hopkins publication workflow project, are promising indicators that these community contributions have led to a solution that stands realistic chances for significant adoption.

## 7. ACKNOWLEDGMENTS

This work was supported by the National Science Foundation Divisions of Information and Intelligent Systems and Undergraduate Education through grant numbers IIS-0430906, IIS-0643784 and DUE-0840744, the Andrew W. Mellon Foundation, Microsoft, and the Coalition for Networked Information. Development of OAI-ORE was based on input from the OAI-ORE Technical Committee, the OAI-ORE Liaison Group, the OAI-ORE Advisory Committee, contributors to the OAI-ORE Google discussion group, and members of the Digital Library Research & Prototyping Team of the Los Alamos National Laboratory. Individuals are listed at

<http://www.openarchives.org/ore/>.

## 8. REFERENCES

- [1] M. Altman and G. King. A proposed standard for the scholarly citation of quantitative data. *D-Lib Magazine*, 13(3/4), 2007.
- [2] D. E. Atkins, K. K. Droegemeier, S. I. Feldman, H. Garcia-Molina, M. L. Klein, D. G. Messerschmitt, P. Messina, J. P. Ostriker, and M. H. Wright. Revolutionizing science and engineering through cyberinfrastructure, 2003.
- [3] J. Bekaert, E. De Koning, and H. Van de Sompel. Representing digital objects using MPEG-21 Digital Item Declaration. *International Journal on Digital Libraries*, 6(2):159–173, 2006.
- [4] C. Bizer, R. Cyganiak, and T. Heath. How to publish linked data on the web, 2007. <http://sites.wiwiw.de/bizer/pub/LinkedDataTutorial/>.
- [5] C. L. Borgman. *Scholarship in the digital age : information, infrastructure, and the Internet*. MIT Press, Cambridge, Mass., 2007.
- [6] A. Boyko, J. Kunze, J. Littman, and L. Madden. The bagit file package format (v0.95), Internet Draft, July 2008.
- [7] D. Chakrabarti, R. Kumar, and K. Punera. A graph-theoretic approach to webpage segmentation. In *WWW '08: Proceedings of the 17th international conference on World Wide Web*, pages 377–386, 2008.
- [8] K. Cheung, J. Hunter, A. Lashtabeg, and D. J. SCOPE - a scientific compound object publishing and editing system. In *3rd International Digital Curation Conference*, 2007.
- [9] S. Choudhury, T. DiLauro, A. Szalay, E. Vishniac, R. Hanisch, J. Steffen, R. Milkey, T. Ehling, and R. Plante. Digital data preservation for scholarly publications in astronomy. *International Journal of Digital Curation*, 2(2), 2007.
- [10] T. DiLauro. OAI-ORE for publishing workflows: Data archiving for journals of the American Astronomical Society. In *Open Repositories 2008*, 2008.
- [11] P. Dmitriev. As we may perceive: finding the boundaries of compound documents on the web. In *WWW '08: Proceedings of the 17th international conference on World Wide Web*, pages 1029–1030, 2008.
- [12] P. Dmitriev, C. Lagoze, and B. Suchkov. As we may perceive: inferring logical documents from hypertext. In *Proceedings of the sixteenth ACM conference on Hypertext and Hypermedia*, pages 66–74, 2005.
- [13] P. N. Edwards, S. J. Jackson, G. C. Bowker, and C. P. Knobel. Understanding infrastructure: Dynamics, tensions, and design. Technical report, National Science Foundation, January 2007.
- [14] N. Eiron and K. McCurley. Untangling compound documents on the web. In *Proceedings of the fourteenth ACM conference on Hypertext and Hypermedia*, pages 85–94, 2003.
- [15] D. Embley, Y. Jiang, and Y. Ng. Record-boundary discovery in Web documents. In *Proceedings of the 1999 ACM SIGMOD international conference on Management of data*, pages 467–478, 1999.

- [16] Google, Microsoft, and Yahoo. Sitemaps XML format, 2008. <http://www.sitemaps.org/protocol.php>.
- [17] J. Gray, A. S. Szalay, A. Thakar, C. Stoughton, and J. vandenBerg. Online scientific data curation, publication, and archiving. Technical Report arXiv cs.DL/0208012, 2002.
- [18] J. Gregorio and B. de hOra. The Atom publishing protocol, Internet RFC-5023, December 2007.
- [19] B. Haslhofer and B. Schandl. The OAI2LOD Server: Exposing OAI-PMH Metadata as Linked Data. In *Proceedings of WWW 2008 Workshop Linked Data on the Web (LDOW2008), Beijing*, 2008.
- [20] M. Hoogerwerf. Durable enhanced publications. In *Proceedings of African Digital Scholarship & Curation 2009*, 2009.
- [21] L. Hunter J., Chueng. Provenance explorer - a graphical interface for constructing scientific publication pack ages from provenance trails. *International Journal on Digital Libraries*, 7(1-2):99–107.
- [22] IMS Global Learning Consortium. IMS content packaging XML binding specification version 1.1.3. <http://www.imsglobal.org/content/packaging/>, 2003.
- [23] I. Jacobs and N. Walsh. Architecture of the world wide web, volume one. Technical Report W3C Recommendation 15 December 2004, W3C, 2004.
- [24] R. K. Johnson. Institutional repositories: Partnering with faculty to enhance scholarly communication. *D-Lib Magazine*, 8(11), 2002.
- [25] C. Lagoze, S. Payette, E. Shin, and C. Wilper. Fedora: an architecture for complex objects and their relationships. *International Journal on Digital Libraries*, 6(2):124–138, 2006.
- [26] C. Lagoze and H. Van de Sompel. The Open Archives Initiative: building a low-barrier interoperability framework. In *JCDL '01: Proceedings of the 1st ACM/IEEE-CS Joint Conference on Digital Libraries*, pages 54–62, 2001.
- [27] C. Lagoze, H. Van de Sompel, P. Johnston, M. Nelson, R. Sanderson, and S. Warner. ORE Specification - Abstract Data Model, 2008. <http://www.openarchives.org/ore/datamodel>.
- [28] C. Lagoze, H. Van de Sompel, P. Johnston, M. Nelson, R. Sanderson, and S. Warner. ORE Specification and User Guide - Table of Contents, 2008. <http://www.openarchives.org/ore/1.0/toc>.
- [29] C. Lagoze, H. Van de Sompel, P. Johnston, M. L. Nelson, R. Sanderson, and S. Warner. Object Re-Use & Exchange: A Resource-Centric Approach. Technical Report arXiv:0804.2273, 2008.
- [30] W. Li, O. Kolak, Q. Vu, and H. Takano. Defining logical domains in a web site. In *Proceedings of the eleventh ACM on Hypertext and Hypermedia*, pages 123–132, 2000.
- [31] C. A. Lynch. Institutional repositories: Essential infrastructure for scholarship in the digital age. *ARL: A Bimonthly Report*, (226), 2003.
- [32] J. P. McDonough. METS: Standardized encoding for digital library objects. *International Journal on Digital Libraries*, 6(2):148–158, 2006.
- [33] P. Murray-Rust and H. Rzepa. The next big thing: From hypermedia to datuments. *Journal of Digital Information*, 5(1), 2004.
- [34] M. Nottingham. HTTP header linking, Internet Draft, March 2008.
- [35] M. Nottingham and R. Sayre. The Atom syndication format, Internet RFC-4287, December 2005.
- [36] L. Sauermann and R. Cyganiak. Cool URIs for the semantic web. Technical Report W3C Interest Group Note 31 March 2008, W3C, 2008.
- [37] K. Scheppe and D. Pentecost. Protocol for Web Description Resources (POWDER): Primer. Technical Report W3C Working Draft – 14 November 2008, W3C, 2008.
- [38] J. E. Sieber and B. E. Trumbo. (not) giving credit where credit is due: Citation of data sets. *Science and Engineering Ethics*, 1:11–20, 1995.
- [39] A. Smith. The research library in the 21st century: collecting, preserving, and making it accessible resources for scholarship. In *No Brief Candle: Reconceiving Research Libraries for the 21st Century*. Council on Library and Information Resources, 2008.
- [40] S. Tuecke, K. Czajkowski, I. Foster, J. Frey, S. Graham, C. Kesselman, T. Maquire, T. Sandholm, D. Snelling, and Vanderbilt. Open Grid Services Infrastructure (OGSI): Version 1.0. Technical Report draft-ggf-ogsi-gridservice-33, Global Grid Forum, January 27 2003.
- [41] H. Van de Sompel, S. Payette, J. Erickson, C. Lagoze, and S. Warner. Rethinking scholarly communication: Building the system that scholars deserve. *D-Lib Magazine*, 10(9), 2004.
- [42] R. Williams, R. Moore, and R. Hanisch. A virtual observatory vision based on publishing and virtual data. Technical report, US National Virtual Observatory, 2003.