



SUBMITTAL DATA – INDOOR UNIT V33B030H4-2P

VRF HEAT PUMP & HEAT RECOVERY

Job: _____

Location: _____

Schedule No.: _____

System Designation: _____

Engineer: _____

Architect: _____

Date: _____

For: Reference Approval Review Construction

3x3 Ceiling Cassette Indoor Unit

FEATURES

- Pre Heat Function
- Integral Condensate Pump
- Flare Connections
- Refrigerant R-410A
- Auto Addressing
- ECM Motor
- LED Display
- Eight capacity sizes from 9,000 to 48,000 Btu/h
- Auto Restart
- 360° Air Distribution
- Washable Filter

SPECIFICATIONS

PERFORMANCE

Cooling Capacity ¹ (Btu/h)		30,000
Heating Capacity ¹ (Btu/h)		34,000
Airflow (CFM)	High	950
	Medium	800
	Low	680
External Static Pressure (in. WC)		-
Sound Pressure (dBA)	High	51
	Medium	47
	Low	44

ELECTRICAL DATA

Power Supply (V/Hz/Φ)	208-230/60/1
Minimum circuit ampacity (MCA)	1.3
Max. Overcurrent Protection (MOCP)	15
Cooling Power Input ² (W)	90
Cooling Rated current (A)	0.80
Heating Power Input ² (W)	83
Heating Rated current (A)	0.80
Indoor Fan Motor Input (W)	88

DIMENSIONS

Unit Dimensions (in)	Height	11-7/8
	Width	33-1/8
	Depth	33-1/8
Diffuser Panel Dimensions (in)	Height	1-3/4
	Width	37-3/8
	Depth	37-3/8
Liquid Pipe Connection (in)		3/8
Gas Pipe Connection (in)		5/8
Condensate drain connection (in)		1-1/4
Unit Shipping Weight (lb)		86
Unit Net Weight (lb)		69
Diffuser Panel Shipping Weight (lb)		18
Diffuser Panel Net Weight (lb)		11



OPTIONAL ACCESSORIES

<input type="checkbox"/> Non-Programmable Controller	V0STAT54P
<input type="checkbox"/> Programmable Controller	V0STAT51P
<input type="checkbox"/> Infrared Wireless Controller	V0STAT52P-1
<input type="checkbox"/> Infrared Sensor	V0SNSR78P-1
<input type="checkbox"/> HHE Relay Kit	V0CTRL92P-1
<input type="checkbox"/> Hotel Keycard Interface	V0CTRL88P-1

NOTES

- Cooling and Heating capacity data is rated at the following conditions:
Cooling: 80°FDB / 67°FWB Indoor, 95°FDB Outdoor
Heating: 70°FDB Indoor, 47°FDB / 43°FWB Outdoor
- Power Input values are rated at high fan speed.

NOTE – Due to Lennox' ongoing commitment to quality, Specifications, Ratings and Dimensions subject to change without notice and without incurring liability. Improper installation, adjustment, alteration, service or maintenance can cause property damage or personal injury. Installation and service must be performed by a qualified installer and servicing agency.





SUBMITTAL DATA - INDOOR UNIT
V33B030H4-2P
 VRF HEAT PUMP & HEAT RECOVERY

DIMENSIONAL DRAWINGS - INCHES (MM)

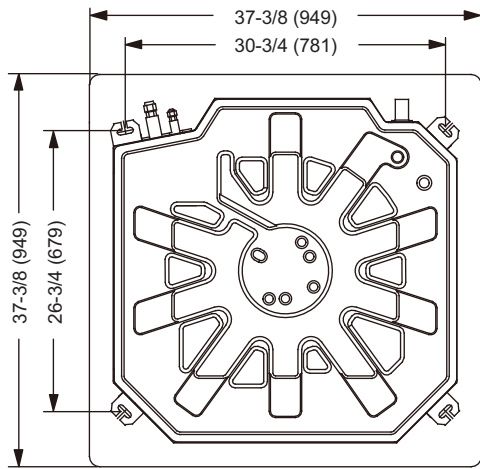

TOP VIEW

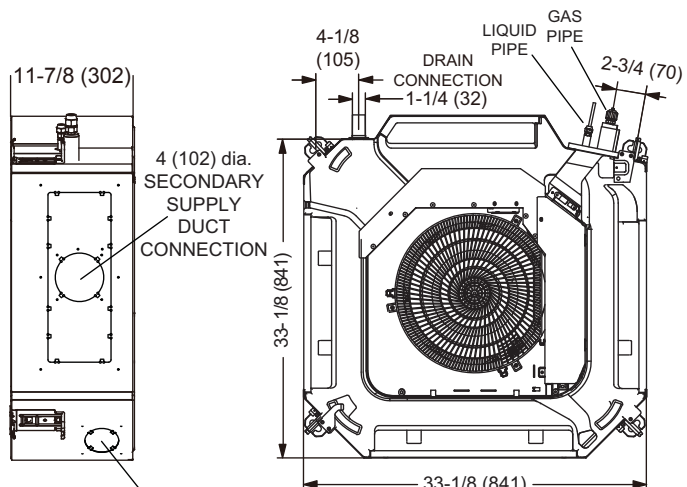

BOTTOM VIEW

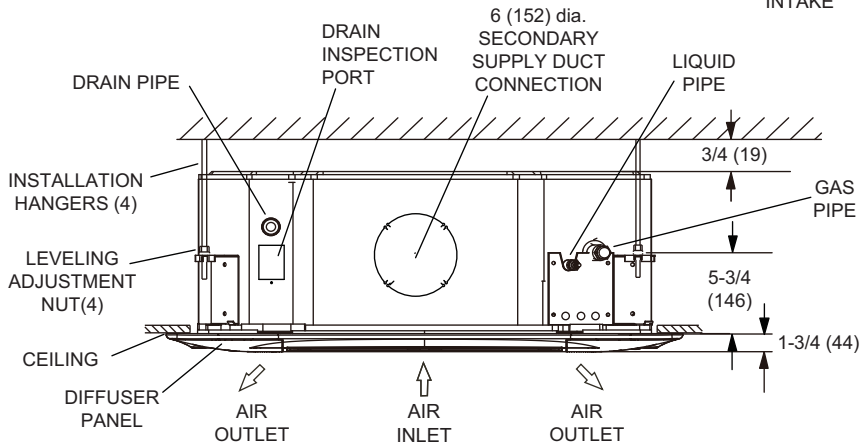

SIDE VIEW

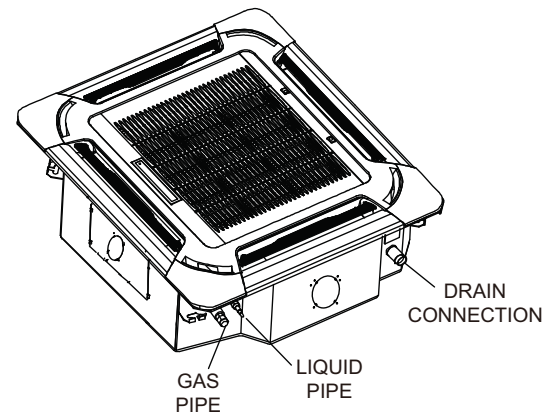

BOTTOM (PANEL) VIEW

NOTE - Due to Lennox' ongoing commitment to quality, Specifications, Ratings and Dimensions subject to change without notice and without incurring liability. Improper installation, adjustment, alteration, service or maintenance can cause property damage or personal injury. Installation and service must be performed by a qualified installer and servicing agency.