

MEASUREMENT OF INDUSTRIAL SHEETMETAL PARTS WITH CAD-DESIGNED DATA AND NON-METRIC IMAGE SEQUENCE

Yongjun Zhang ^{a, b}

a. School of Remote Sensing and Information Engineering, Wuhan University, Wuhan, 430079, China

b. College of Hydropower & Information Engineering, Huazhong University of Science & Technology, China
yongjun_zhang@sina.com, yjzhang@supresoft.com.cn

Commission V

KEY WORDS: Photogrammetry, Industry, CAD, Image sequence, Matching, Reconstruction, Measurement

ABSTRACT:

A novel approach for three-dimensional reconstruction and measurement of industrial parts with CAD-designed data and non-metric image sequence is proposed. The purpose of our approach is to automatically reconstruct and thus measure the producing imprecision or deformations of industrial parts mainly composed of line segments and circles with information extracted from imagery. Non-metric image sequence and CAD-designed data are used as sources of information. Principles of 2D and 1D least squares template matching to extract precise lines and points are presented. Hybrid point-line photogrammetry is adopted to get accurate wire frame model of industrial parts. Circles, arcs and lines connected to each other on the part are reconstructed with direct object space solution according to known camera parameters. The reconstructed CAD model can be used for visual measurement. Experimental results of several parts are very satisfying, which shows that the proposed approach has a promising potential in automatic 3D reconstruction and measurement of widely existed industrial parts mainly composed of lines, circles, connected arcs and lines.

1. INTRODUCTION

Three-dimensional (3D) reconstruction from imagery is one of the most active areas in Close-Range Photogrammetry and Computer Vision. Since Computer Aided Design (CAD) is widely used and most industrial parts have their corresponding CAD-designed data, precision evaluating and quality control of industrial parts with reference of CAD data receive much concern in industrial communities. Reducing manpower, maintaining high precision and consistency, and time of measurement are the main foci of researchers.

Coordinate Measurement Machine (CMM) is the mostly used measuring equipment in industrial communities. But the cost and speed of CMM are still major problems to be resolved (Steven, 1999). Stereo vision technique with two CCD cameras and two infrared LED lamps is used by (Kosmopoulos 2001) in measurement of gaps on the automobile production line, results of about 0.1mm precision within an area of 80mm×80mm are obtained. Along with the development of computer vision, two-dimensional automated visual inspection has been widely used in Printed Circuit Board product lines (Moganti et al 1996). Although automated vision metrology getting more and more mature (c.f. Fraser 1999, Pappa et al 2002), there is no practical 3D vision system that can substitute man efforts in imprecision measurement and quality control for widely existed small-scale industrial parts such as sheetmetal parts.

Line photogrammetry is used in the reconstruction of objects mainly represented by polyhedral models. Several approaches have been proposed to reconstruct architectures in the last years (Debevec 1996, Heuvel 1999). Photogrammetric techniques are also used in 3D reconstruction of industrial installations

(Vosselman 2000) and reverse engineering (Ermes 2000) with CAD models. Although all of these systems are semi-automatic and time-consuming, line photogrammetry still shows a well potential in automatic 3D reconstruction especially in the case of known initial model of the interested object.

In this paper, a new approach of reconstructing and measuring industrial sheetmetal parts with CAD-designed data and non-metric image sequence is proposed. The general strategy is to reconstruct and measure industrial parts quickly and accurately using techniques of hybrid point-line photogrammetry and direct object space solution with CAD-designed data and information extracted from the imagery. A planar grid is used to calibrate the non-metric CCD camera and provide initial values of camera parameters during reconstruction. CAD-designed data represents the initial model of the part and the topology of the reconstructed one. Least-Squares Template Matching (LSTM) and several matching results are discussed in section 2. Afterwards, detailed approach of reconstructing industrial parts mainly composed of line segments, circles, connected arcs and circles is presented. The reconstructed CAD model can be used to measure producing imprecision or deformations. System overview and experimental results are discussed in section 4. And section 5 concludes the paper.

2. LEAST SQUARES TEMPLATE MATCHING

2.1 Line Template Matching

Image points and lines are the most effective characteristics used for 3D reconstruction in photogrammetry and computer vision. If “Minimization of the squared sum of grey-difference”

is chosen as criteria, image matching equation is $\sum v = \min$. If only random noises are considered, error equation of image matching will be $v = g_1(x, y) - g_2(x, y)$. This is the basic principle of least-squares template matching (Gruen 1985, Schenk 1999) which is widely used in digital photogrammetry. Line template matching is a two dimensional technique. Length of image window is usually more longer than 10 pixels. Image patch is usually rotated into horizontal to facilitate matching. As shown in Figure 1, the level rectangle represents the standard template for matching, while the dashed rectangle represents the image patch to be matched. Displacement along the line is not important in image matching, but the angle between template and image must be eliminated, so two unknowns dy_1 and dy_2 are essential to fit the small rotation angles between image patche and template. Note that real template should be generated according to image patch before image matching.

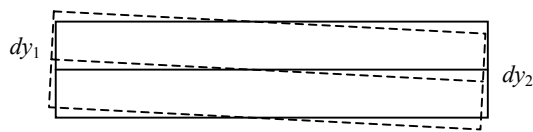

Figure 1. Two unknowns in line template matching

Grid points are detected as the intersection of two matched lines fitted to each corner, as shown in Figure 2. The black crosses are the predicted image corners, and the white crosses are the matched ones. The precision of image matching results is higher than 0.05 pixels.

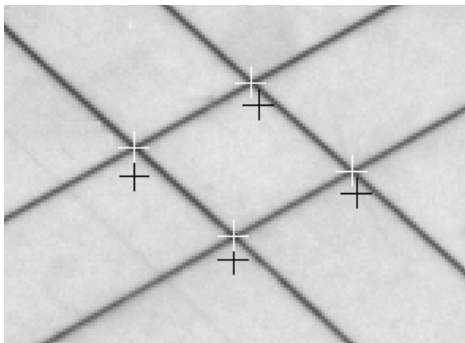

Figure 2. Initial projections and matched results of points

Left of Figure 3 shows the initial projections of line segments of the part. The initial image lines are usually several pixels away from the real image edges. Although many rusts exist on the part and can be seen clearly, the matched image lines are well fitted to the real image edges (right of Figure 3). Actually, the matching precision is also higher than 0.05 pixels.

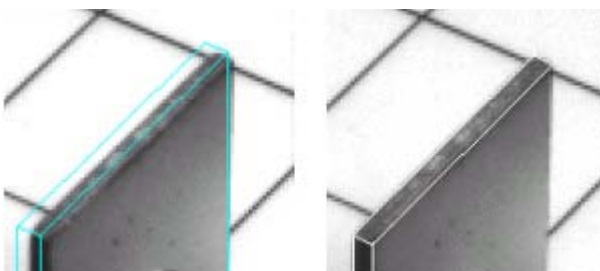

Figure 3. Initial projections and matched results of lines

2.2 One-dimensional Point Template Matching

As we know, a line can be represented by a group of colinear small segments. If image window of line template matching is subdivided into small segments, each with a length of 2-5 pixels, named "point segment", the rotation angle between standard template and small point segment can be neglected. Matching between the "point segment" and template is called point template matching in this paper. Different from line template matching, there is only one unknown for one-dimensional point template matching, the vertical shift dr between template and image, as shown in Figure 4. Angle is assumed to be not existed, since the length of point segment is usually very short. Figure 5 shows the initial projection and matched result of a circle by one-dimensional point template matching. Although there are many rusts, the matched circle is well fitted to the image.

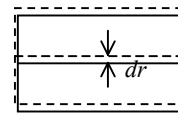

Figure 4. One unknown in point template matching

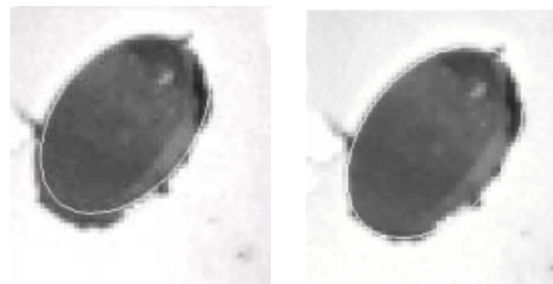

Figure 5. Initial projection and matched result of a circle

3. 3D RECONSTRUCTION OF INDUSTRIAL PARTS

The topology of CAD data of sheetmetal part is assumed to be correct since it is designed on computer and often checked many times before the part is produced. But the geometry of sheetmetal part is usually not the same as CAD-designed data because of mis-operation during producing or deformations after a period of usage. Detailed approach of how to reconstruct the correct geometric model with the designed data and information extracted from imagery will be discussed.

In this paper, world coordinate system is chosen the same as the one of grid. Generally, coordinate system of the industrial part defined in CAD-designed data will not be identical with the world one, there are at most six elements of rotation and translation to convert the CAD coordinate system into world coordinate system (grid coordinate system).

Sheetmetal parts are mostly composed of line segments. This is the reason that we choose line photogrammetry to reconstruct and measure them. As shown in Figure 6, the image line pq , space line PQ and the projection center S should be coplanar, while p and P , q and Q are not necessarily correspondences, which is the most important advantage of line photogrammetry (Debevec 1996). A line in the image can be parameterised in several ways. Although two parameters are sufficient for representation of an image line, four image coordinates of two end points are used here, because it is singularity-free and easy

to setup error equations.

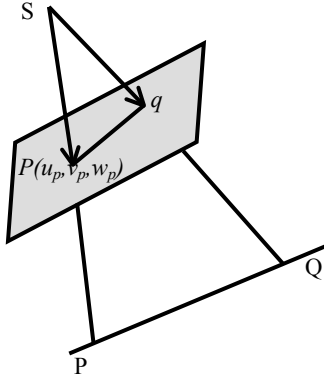

Figure 6. Coplanarity between space and image lines

The coplanar equation among p , S , P and Q is:

$$\begin{vmatrix} u_p & v_p & w_p \\ X_p - X_S & Y_p - Y_S & Z_p - Z_S \\ X_Q - X_S & Y_Q - Y_S & Z_Q - Z_S \end{vmatrix} = 0 \quad (1)$$

where (u_p, v_p, w_p) is the model coordinate of image point p , (X_S, Y_S, Z_S) the coordinate of S , (X_P, Y_P, Z_P) and (X_Q, Y_Q, Z_Q) the coordinates of part points. Error equation of line photogrammetry can be written as:

$$\begin{aligned} & A_1 dx_p + A_2 dy_p + A_3 d\varphi + A_4 d\omega + A_5 d\kappa + A_6 dX_S + \\ & A_7 dY_S + A_8 dZ_S + A_9 d\varphi^0 + A_{10} d\omega^0 + A_{11} d\kappa^0 + \\ & A_{12} d\Delta X^0 + A_{13} d\Delta Y^0 + A_{14} d\Delta Z^0 + A_{15} dX_p^0 + A_{16} dY_p^0 + \\ & A_{17} dZ_p^0 + A_{18} dX_Q^0 + A_{19} dY_Q^0 + A_{20} dZ_Q^0 + F_x = 0 \end{aligned} \quad (2)$$

where $A_1 \sim A_{20}$ are the partial derivatives of unknowns and F_x the constant item. Besides the coplanar equation among p , S , P and Q , there exists another equation among q , S , P and Q . The linearised form is similar to that of equation (2).

For parts that are very simple or there are a few line segments, the geometric configuration is very poor. Grid points should be combined into the adjustment model to ensure the reliability of reconstruction. Error equations of grid points are:

$$\begin{aligned} v_x &= B_1 d\varphi + B_2 d\omega + B_3 d\kappa + B_4 dX_S + B_5 dY_S + \\ & B_6 dZ_S + B_7 dX + B_8 dY + B_9 dZ - l_x \\ v_y &= C_1 d\varphi + C_2 d\omega + C_3 d\kappa + C_4 dX_S + C_5 dY_S + \\ & C_6 dZ_S + C_7 dX + C_8 dY + C_9 dZ - l_y \end{aligned} \quad (3)$$

where l_x, l_y are constant items, $B_1, \dots, B_9, C_1, \dots, C_9$ coefficients of unknowns. Please refer to (Kraus 1993) for more detail about the coefficients of error equations. If the coordinates of grid points can be treated as known, terms of (dX, dY, dZ) should be removed from the error equations. The

model of hybrid point-line photogrammetry is composed of equation (2) and equation (3). It can be used to reconstruct the wire frame model of parts.

For lots of board-like industrial parts, the reconstruction of complex shapes is also very important but hard to deal with in practice. An effective approach to reconstruct circles, connected arcs and lines based on one-dimensional point template matching and direct object space solution will be presented in the following.

Camera parameters, which can be obtained with hybrid point-line photogrammetry, are treated as known. Since the end points of small line segments are results of template matching and also functions of space circles or lines, the parameters of space circles or lines and images are related directly. Thus parameters of circles, arcs and lines can be obtained directly from several images by least squares template matching.

Suppose the plane where circle or arc lies in is known. This is true since the plane can be determined by the reconstructed wire frame CAD model. The camera parameters of the images can be rotated to level the plane. So the circle equation in the level plane is very simple:

$$\begin{aligned} X &= X_0 + R \cdot \cos \theta \\ Y &= Y_0 + R \cdot \sin \theta \end{aligned} \quad (4)$$

where X_0, Y_0 and R are the center and radius of circle or arc, θ varies from 0 degree to 360 degree for circle, and from start angle to end angle for arc. In this paper, circles and arcs are represented by a number of points with certain intervals of different angle θ . The top of Figure 7 is a space circle, and the bottom is the projected ellipse with known camera parameters. Each point A on the space circle defined by θ has its corresponding point a in the image.

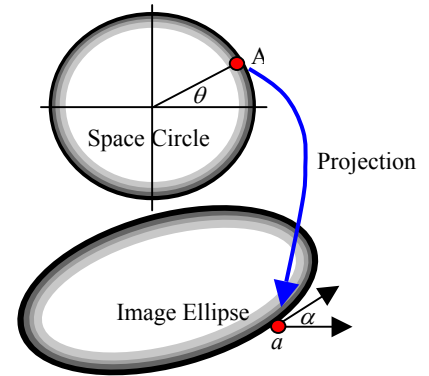

Figure 7. Projected image point of circle

If equation (4) is substituted into collinearity equations, the unknowns are the center and radius of circle or arc since Z is a fixed value after rotation. For certain angle θ , the object point is projected onto image and the tangential vector with angle α can be easily determined. A small window with length of 2-5 pixels taken the projected image point as center and α as tangential vector is rotated into horizontal, followed by one-dimensional point template matching. The displacement dr determined by template matching can be rotated back to image

coordinate system according to α . Error equations of circle or arc reconstruction can be written as:

$$\begin{aligned} v_x &= A_1 \cdot dX_0 + A_2 \cdot dY_0 + A_3 \cdot dR - dx \\ v_y &= B_1 \cdot dX_0 + B_2 \cdot dY_0 + B_3 \cdot dR - dy \end{aligned} \quad (5)$$

where $A_1, A_2, A_3, B_1, B_2, B_3$ are the coefficients of unknowns, dx, dy constant items. Thus the parameters of space circles or arcs can be obtained directly from one or several images by LSTM with initial values obtained from CAD data and known camera parameters. The obtained parameters of circles or arcs should be rotated back to world coordinate system according to camera parameters.

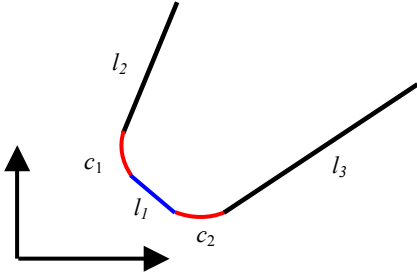

Figure 8. Connected arcs and lines

In modern industry, arcs in parts are usually connected to lines. As shown in Figure 8, two arcs c_1, c_2 and three line segments l_1, l_2 and l_3 are connected to each other. Generally, they are very difficult to reconstruct precisely. The model of obtaining uniform solution of arcs and lines will be addressed. For convenience of reconstruction, line segments are also rotated into a level plane, and represented as follows:

$$\begin{aligned} X &= X_s + i \cdot \Delta L \cdot \cos \beta \\ Y &= Y_s + i \cdot \Delta L \cdot \sin \beta \end{aligned} \quad (6)$$

where X_s, Y_s is the start point of line segment, β denotes the direction of the line, ΔL is the length of small segment approximately equal to the length of point window in circle and arc matching. Error equations of line reconstruction are:

$$\begin{aligned} v_x &= M_1 \cdot dX_s + M_2 \cdot dY_s + M_3 \cdot d\beta - dx \\ v_y &= N_1 \cdot dX_s + N_2 \cdot dY_s + N_3 \cdot d\beta - dy \end{aligned} \quad (7)$$

where M_1, M_2, M_3 and N_1, N_2, N_3 are coefficients of unknowns, dx, dy constant items. The circle or arc reconstruction equation (5) can be combined with line reconstruction equation (7) to get an uniform solution of connected arcs and lines. To ensure the stability of reconstruction, several geometric constrains should be added, such as the center of arc c_1 should lies on bisector of line l_1 and l_2 , the center of arc c_2 should lies on bisector of line l_1 and l_3 , the three lines should be tangential to the two arcs etc.

4. EXPERIMENTS

4.1 Overview of the System

To reduce the cost of measurement, only one non-metric CCD camera is used. Figure 9 shows the hardware configuration of the system. A planar grid is fixed on the rotation table for camera calibration and offering initial values of camera parameters during reconstruction. The part to be reconstructed is put on the grid. Image sequence is obtained while the table rotating under computer control. As mentioned in section 3, world coordinate system is chosen the same as that of grid.

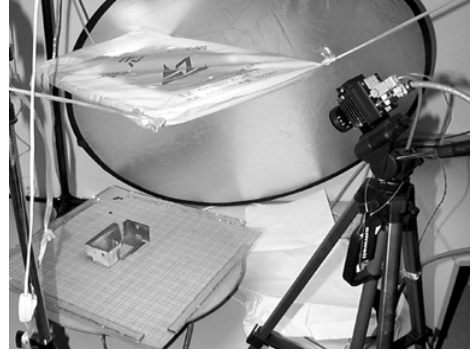

Figure 9. Hardware configuration of the measurement system

The developed software runs fully automatically. It can be used to reconstruct and measure industrial parts mainly composed of lines, circles, connected arcs and lines. The system is composed of 4 steps. Firstly, Image sequence is acquired by CCD digital camera automatically while the table turns around its center controlled by computer. Image points and lines are obtained by LSTM simultaneously with image acquiring. Then 3D wire frame model of the part is reconstructed accurately with hybrid point-line photogrammetry. Afterwards, circles, connected arcs and lines are reconstructed by direct object space solution. Finally, measurement can be done automatically or interactively.

4.2 Real Data Experiments

The measurement system has been tested with real image data of several parts taken by a pre-calibrated CCD camera (Zhang et al 2003). Experiments of two parts both with dimension of about 150mm will be presented in the following. The part to be reconstructed is put on the planar grid, which is fixed on the turntable. The CCD camera is fixed on a tripod with distance of about 600mm to the part. One image of each part is shown in Figure 10. A sequence of 25 images for each part is taken with equal angle intervals while the table turns around. Image matching is made simultaneously with image acquiring. Grid points are detected as the intersection of two line segments fitted to each corner. Lines are obtained by LSTM with initial values projected by the CAD-designed data and the camera parameters provided by the grid. Occlusions are detected before template matching to reduce mismatches.

White lines in Figure 10 are the matched lines of parts. There is nearly no mismatch for points of planar grid. But for parts that are very thin, there maybe some mismatched lines. Most of them can be removed successfully with Trifocal tensor (Hartley et al 2000) computed with camera parameters provided by the planar grid. The remained mismatches can be eliminated during

the iterative least squares adjustment.

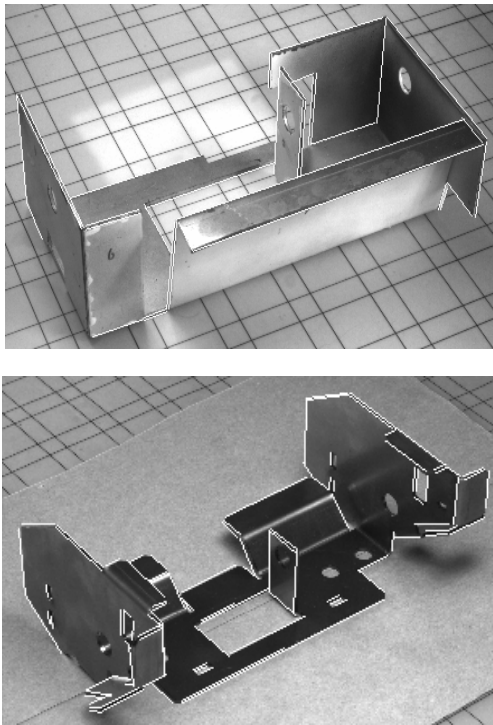

Figure 10. One image for each part to be measured

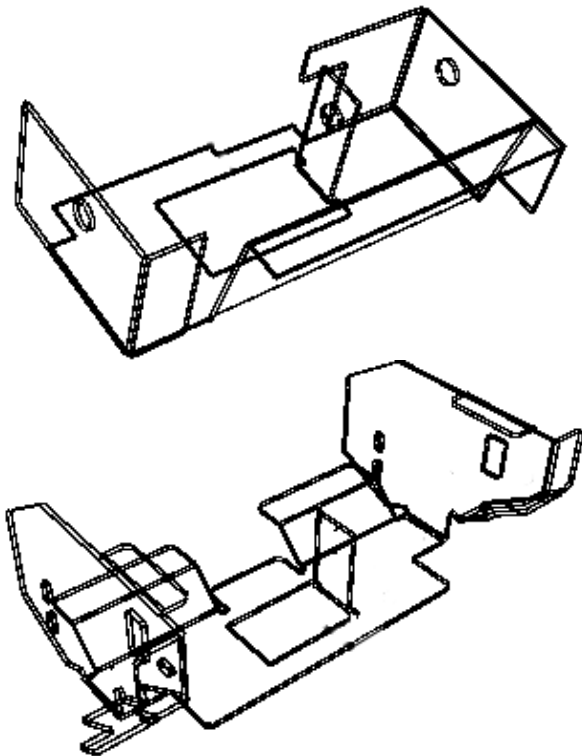

Figure 11. Reconstructed 3D view of the two parts

The system can generate final CAD model for each industrial part within 3 minutes (including image acquiring) in a PIV personal computer. Results of reconstruction are displayed with OpenGL (Figure 11) and can be used to measure the producing imprecision and deformation automatically or interactively.

In order to evaluate the precision of the reconstruction and measurement system, 25 distances between lines and planes on sheetmetal parts are measured by callipers and compared with the reconstructed CAD model (Figure 12). The distance between a line and a plane is defined as the mean of two distances from the two end points of a line to the plane determined by all points in it. Coordinates of points are obtained from the reconstructed CAD model. Distances between lines, planes are defined in a similar way. “Producing imprecision” means distances between lines, planes or line to plane measured by callipers subtracting the corresponding designed distances. “Computed imprecision” means distances computed with the reconstructed CAD model subtracting the corresponding designed distances.

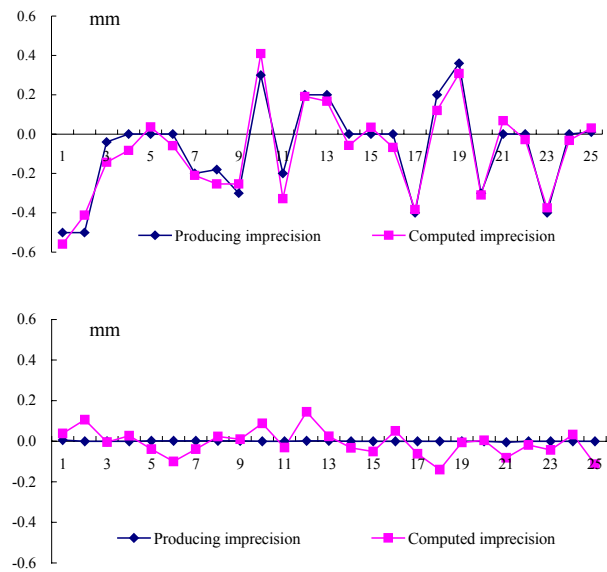

Figure 12. Measuring results of the two parts

It can be seen from top of Figure 12 that the largest “producing imprecision” of the first part is about 0.5mm, i.e., the maximum difference between the real part and the designed CAD model is 0.5mm. Note that all imprecision larger than 0.1mm can be detected accurately by the proposed system. Measured distances of the second part are very close to that of CAD data, i.e., the producing imprecision is nearly zero. Deviations of computed imprecision show a well normal distribution (bottom of Figure 12). The RMS error of deviation is 0.070mm and 0.067mm for the two parts, respectively. The relative precision, which can be calculated as the ratio of RMS against the distance between camera and part, are both higher than 1/8000 (0.07mm/600mm = 1/8570), which shows the precision of the proposed system when manually measured distances are treated as errorless. Actually, distances measured by callipers cannot be errorless, so precision of the proposed system should be higher than 1/8000.

The proposed circle reconstruction approach is also tested with several real image data. Top of Figure 13 shows two projections of a circle with CAD designed data and camera parameters obtained from hybrid point-line photogrammetry. As can be seen, there are many rusts on the circle. The reconstructed projections (bottom of Figure 13) are well fitted with actual image ones. The diameter of reconstructed circle is 9.948mm, very close to the real value 10.00mm measured by callipers.

Top of Figure 14 shows the initial projections in 2 images of 4 arcs and 4 lines connected to each other. The length of shorter line segments is about 12 pixels in image, and a few pixels for arcs. They are very difficult to reconstruct with common strategies. But for the proposed technique of object space solution with geometric constraints, they can be reconstructed easily and stably. The projection of reconstructed model is also well fitted to images (bottom of Figure 14).

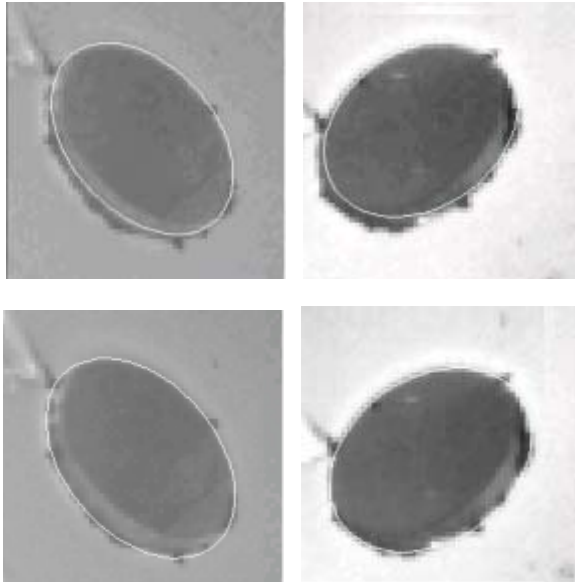

Figure 13. Initial (top) and reconstructed (bottom) projections of a circle

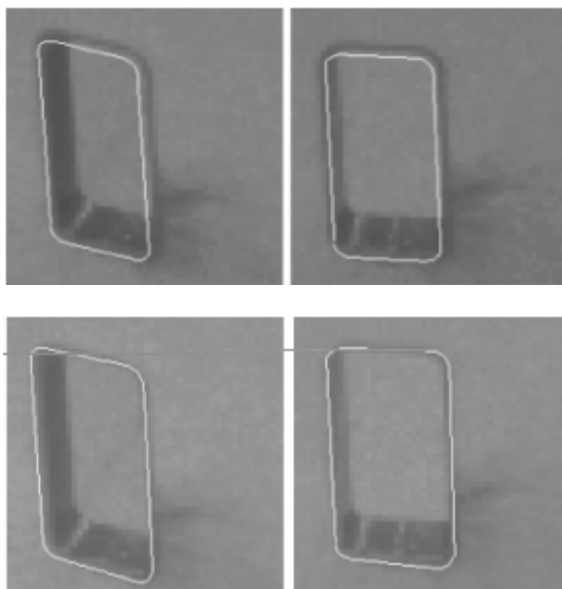

Figure 14. Initial (top) and reconstructed (bottom) projections of connected arcs and lines

5. CONCLUSIONS

An effective approach for 3D reconstruction and measurement of industrial parts mainly composed of line segments, circles, connected arcs and lines with non-metric image sequence and CAD-designed data is proposed. Wire frame model of industrial

part can be accurately reconstructed with hybrid point-line photogrammetry. Circles, arcs and lines connected to each other are reconstructed by one-dimensional point template matching and direct object solution with known camera parameters from hybrid adjustment.

Experiments of real images are very satisfying. The relative precision is higher than 1/8000, and all imprecision larger than 0.1mm can be detected accurately. The proposed reconstruction and measurement technique also has the advantages of low cost of hardware and fully automatic. It shows a promising potential in automatic 3D reconstruction and measurement of industrial parts mainly composed of lines, circles, connected arcs and lines.

REFERENCES

- Debevec P., 1996. Modelling and Rendering Architecture from Photographs: A hybrid geometry- and image-based approach [R], University of California at Berkeley
- Ernes P., 2000. Constrains in CAD Models for reverse Engineering using Photogrammetry [C]. IAPRS, Vol. XXXIII, part B 5/1: 215-221.
- Fraser C., 1999. Automated Vision Metrology: A Mature Technology For Industrial Inspection And Engineering Surveys [C]. 6th South East Asian Surveyors Congress Fremantle, Western Australia, 1-6 November 1999
- Gruen A., 1985. Adaptive least square correlation: a powerful image matching technique [J]. South African Journal of Photogrammetry and Remote Sensing, 14(3): 175-187.
- Hartley R., Zisserman A., 2000. Multiple View Geometry in Computer Vision [M]. Cambridge University Press, UK.
- Heuvel F. A., 1999. A Line- photogrammetry mathematical model for the reconstruction of polyhedral objects [C], Proceedings of SPIE, Vol. 3641: 60-71.
- Kraus K., 1993. Photogrammetry, Volume 1: Fundamentals and Standard Processes [M]. Dummmler Bonn.
- Kosmopoulos D, Varvarigou T., 2001. Automated inspection of gaps on the automobile production line through stereo vision and specular reflection [J]. Computer in Industry, 46: 49-63
- Moganti, M., Ercal, F., Dagli, CH, et al., 1996. Automatic PCB Inspection Algorithms: A Survey [J]. Computer Vision and Image Understanding, Vol. 63, No. 2: 287-313, 1996.
- Pappa R., Jones T., Black J. et al., 2002. Photogrammetry Methodology Development for Gossamer Spacecraft Structures [R]. NASA/TM-2002-211739, Langley Research Center, USA.
- Schenk T., 1999. Digital Photogrammetry [M]. TerraScience, USA.
- Steven S., 1999. Dimensional Inspection Planning for Coordinate Measuring Machines [D]. California: University of Southern California.
- Vosselman, G. and Tangelder J.W.H., 2000: 3D Reconstruction of Industrial Installations by Constrained Fitting of CAD Models to Images [C]. Mustererkennung 2000, Sommer G. et al, (Eds.), Springer Verlag: 285-292.
- Zhang Y., Zhang Z., Zhang J., 2003. Camera Calibration Technique with Planar Scenes [C]. Proceedings of SPIE, Vol. 5011: 291-296.