

PermaEdge Gravel Stop 2

INSTALLATION INSTRUCTIONS

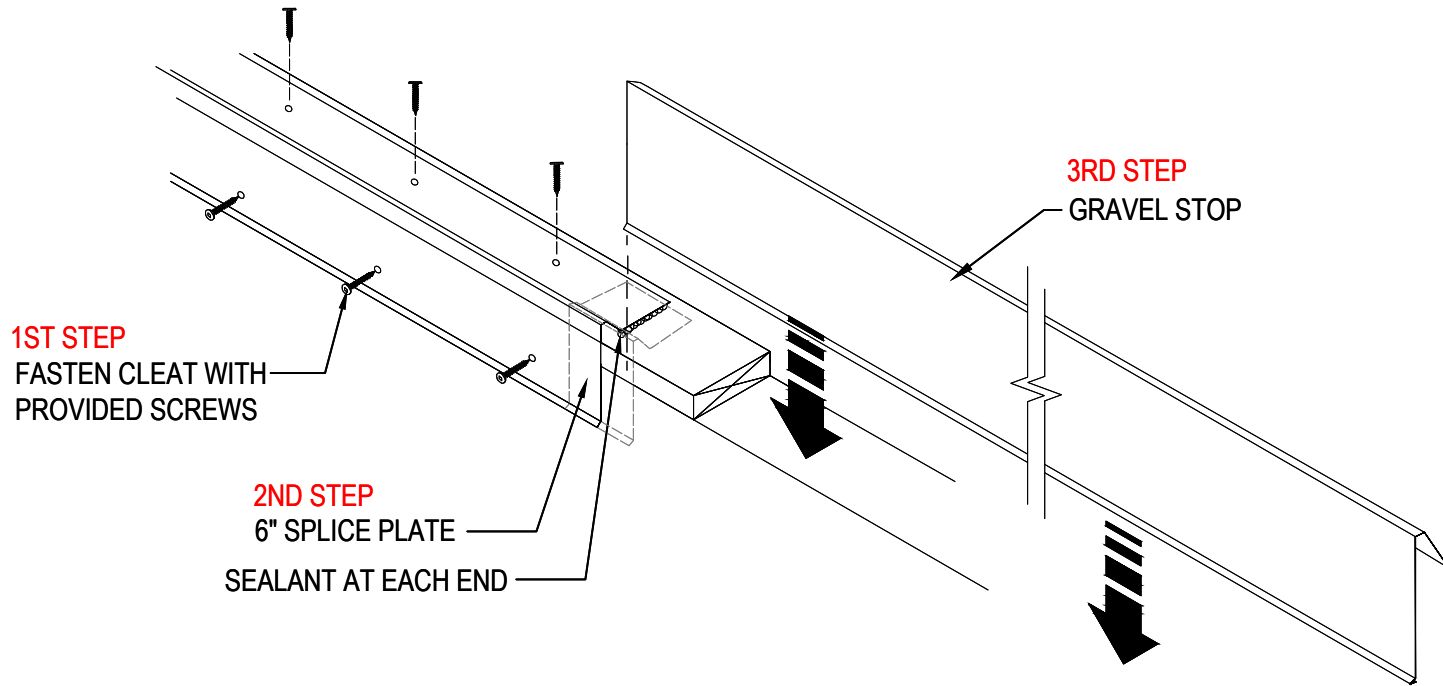

STEP 1, INSTALL 22 GA. GRAVEL STOP CLEAT WITH PROVIDED SCREWS FROM MANUFACTURER. INSTALLED 12" O.C. AND MAKE SURE TO ADD SEALANT AT SEAMS.

STEP 2 INSTALL 6" SPLICE PLATE (10' INCREMENTS).

STEP 3 INSTALL SNAP-ON GRAVEL STOP. (PUSH GRAVEL STOP DOWN UNTIL IT HOOKS INTO THE HEM ON THE CLEAT.

NOTE: REMOVE PROTECTIVE FILM IMMEDIATELY AFTER INSTALLATION.

TYPICAL INSTALLATION

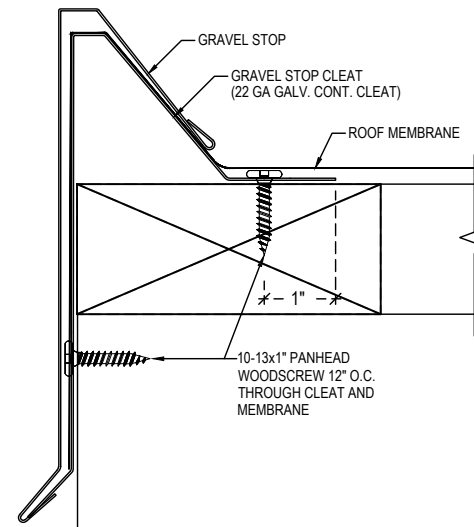

Corporate Office:
1200 Amboy Avenue
Perth Amboy, NJ 08861

Customer Support:
1-800-ENGLERT

WWW.ENGLERTINC.COM

DATE: 09/13/2022

DRAWN BY: NY

SHEET# 1 OF 1

DWG# G2