



BANK OF ENGLAND

Self-assessment of the Bank of England's
Real-Time Gross Settlement and CHAPS services
against the Principles for Financial Market
Infrastructures

December 2018

Contents

I	Preface	4
II	Executive summary	6
III	Introduction	20
IV	Service description	22
	Annex 1 – Key documents relating to the RTGS and CHAPS services	53
	Annex 2 – Useful links	54
	Annex 3 – Glossary	56
	Principle 1-Legal Basis	63
	Principle 2-Governance	70
	Principle 3-Framework for the comprehensive management of risks	81
	Principle 4-Credit risk	88
	Principle 5-Collateral	93
	Principle 7-Liquidity risk	97
	Principle 8-Settlement finality	100
	Principle 9 - Money Settlements	104
	Principle 13-Participant default rules and procedures	105
	Principle 15-General business risk	111
	Principle 16-Custody and Investment risks	114
	Principle 17-Operational risk	117
	Principle 18 - Access and participation requirements	133
	Principle 21-Efficiency and Effectiveness	145
	Principle 22-Communication procedures and standards	151
	Principle 23-Disclosure of rules, key procedures and market data	153

I Preface

- I.I The Bank of England, as operator of the RTGS and CHAPS services, is publishing a self-assessment against the Principles for Financial Market Infrastructures (PFMIs). This is the first joint assessment combining our role as the operator of the RTGS infrastructure and our operation of the CHAPS payment system. This follows the transfer of responsibility for CHAPS to the Bank in November 2017.
- I.II The formal assessment has been completed as of end-June 2018. The accompanying Introduction document (which includes a service description), and principle-by-principle narrative closely follow the published PFMI disclosure template. This is to aid comparison with the disclosures published by the operators of other FMIs. However, it is important that this formal assessment is put in a broader context in two key respects.
- I.III First, the UK has long been unusual internationally in separating delivery of its high-value payment system (CHAPS) from the underlying RTGS infrastructure. Following a strategic review, the Bank commenced ‘direct delivery’ of the CHAPS system in November 2017. The Bank now operates the two services with combined operations, risk and analytical teams, all sitting under an integrated and strengthened set of governance and risk management arrangements. As of the PFMI assessment date (June 2018), these arrangements had been established, and were being embedded. We will continue to refine and embed these arrangements. The Bank’s self-assessment of the RTGS and CHAPS services reflects this.
- I.IV Second, this is a point in time assessment. It is a snapshot of the RTGS and CHAPS services against the continued backdrop of sustained and significant change.
- On 9 May 2017, the Bank published a Blueprint for RTGS renewal. The Bank will design the renewed RTGS to deliver a resilient, flexible and innovative sterling payment system for the United Kingdom to meet the challenges posed by a rapidly changing landscape. The renewed RTGS service will be delivered through a multi-year programme of work. Section II.18-II.20 describes in greater detail the programme that will deliver this enhanced infrastructure.
 - Whilst the majority of the improvements identified in the Blueprint for RTGS renewal will be delivered over the next few years, certain enhancements have already been implemented, or are in progress. These include the widening of the RTGS access criteria

to include non-bank Payment Service Providers¹, and implementation of the common payment messaging standard, ISO 20022, for a large proportion of the retail and wholesale UK payments. These are covered in more detail under the relevant principles.

- There have also been other changes that will enhance the delivery of the RTGS and CHAPS services following the point of assessment. These include the creation of a dedicated Risk Directorate within the Bank in October 2018, bringing together our second-line risk functions; enhancements that follow from the completion of the effectiveness review over the RTGS/CHAPS Board; and on-going activities to draw on the full resources of the Bank to enhance our end-to-end systemic risk manager role, as envisaged in the Blueprint.

Bank of England

December 2018

¹ CHAPS access criteria were also widened to include non-bank payment service providers.

II Executive summary

- II.1 This publication is the Bank of England's public disclosure and self-assessment for the RTGS and CHAPS services against the Principles for Financial Market Infrastructures (PFMIs).² The self-assessment assesses the RTGS and CHAPS services as at end-June 2018. This is the first time the Bank has undertaken a self-assessment combining both the RTGS and CHAPS services, following the transfer of CHAPS to the Bank in November 2017.
- II.2 Consistent with the objectives of the PFMIs, this assessment has been completed by the Bank in its role as operator of the RTGS and CHAPS services, and not in its broader roles as supervisor of financial market infrastructures and banks.³ As part of the public disclosure, an updated description of the RTGS and CHAPS services is also being published.
- II.3 The Bank will continue to update the public disclosure and self-assessment of the CHAPS and RTGS services on a broadly annual basis.
- II.4 The Bank has embarked on its RTGS Renewal Programme to develop a renewed Real-Time Gross Settlement (RTGS) service. Whilst the refreshed technical infrastructure won't be operational in the short term, certain aspects of the Programme, such as the broadening of access to new types of institutions, are already live. This section summarises the current self-assessment as well as providing broader context around the provision of the RTGS and CHAPS services and how the UK's payments landscape is changing.

What are RTGS and CHAPS?

- II.5 'RTGS' stands for Real-Time Gross Settlement – the real-time settlement, in central bank money, of payments, transfer instructions or other obligations individually on a transaction-by-transaction basis.
- II.6 The terms 'RTGS' and 'HVPS' (High-Value Payment System) are often used interchangeably to describe a country's wholesale payment system, given that both services are often offered by the central bank. Indeed since November 2017, the Bank has been responsible for operating both of the UK's RTGS and HVPS (known as 'CHAPS') services.

² The Principles are international standards for the risk management of Financial Market Infrastructures; see http://www.bis.org/cpmi/info_pfmi.htm. There is additional guidance covering application of the Principles to FMIs operated by central banks; see <https://www.bis.org/cpmi/publ/d130.htm>.

³ Unless stated otherwise, references to banks include building societies.

The Bank operates the RTGS and CHAPS services in support of its mission to promote the good of the people of the United Kingdom by maintaining monetary and financial stability.

RTGS

- II.7 The Bank's RTGS infrastructure is an accounting system (or ledger) that records financial institutions' holdings of sterling balances in central bank money, called 'reserves', at the Bank.⁴ These balances can be used to settle the obligations arising from payments and securities transactions made by financial institutions and their customers on a gross or net basis.
- II.8 These considerations show that the UK's RTGS is not a payment system per se. Rather, it is the infrastructure that permits the final settlement of obligations, arising from payments and securities transactions, across accounts at the central bank. In addition to the CHAPS payment system, RTGS provides sterling settlement in central bank money for a number of privately operated payments systems. RTGS provides sterling settlement for UK's securities settlement system, CREST, managed by Euroclear UK & Ireland, four retail payment systems operated by Pay.UK (formerly the New Payment Systems Operator) (Bacs, Cheque & Credit (paper), Faster Payments, the Image Clearing Scheme for cheques) and two other retail payment systems (LINK and Visa). The sterling pay-in and pay-out legs of CLS Bank (a multi-currency settlement system) as well as the embedded sterling payment arrangements for LCH Ltd are also settled, via CHAPS, across RTGS. A separate function at the Bank undertakes prudential supervision of payment systems⁵ and other FMIs.

CHAPS

- II.9 CHAPS is the UK's high value payment system. A payment system is a set of arrangements to facilitate the transfer of money. The arrangements are typically made up of a rulebook, infrastructure, messaging services, and contractual arrangements between the payment system operator and the participants. The Bank is the 'payment system operator' for CHAPS. The Bank, as operator of CHAPS, sets the rules and technical standards for the CHAPS system and acts as a systemic risk manager. The Bank, as operator of RTGS, provides the settlement infrastructure for CHAPS.

⁴ Central bank money is the ultimate secure and liquid asset, offering the lowest risk means of final settlement of the claims and liabilities that arise between the participants in payment systems.

⁵ The Treasury recognises payment systems under the Banking Act 2009 for supervision by the Bank. A list can be found on the Bank's website, see http://www.bankofengland.co.uk/financialstability/Pages/fmis/supervised_sys/rps.aspx.

- II.10 Other key parts of the end-to-end payment systems are the CHAPS Direct Participants who submit CHAPS settlement instructions to RTGS, via the SWIFT network; the SWIFT network used for CHAPS payment messages; indirect participants and end-users who access CHAPS payments via one of the CHAPS Direct Participants; and a range of hardware, software and other service providers to these organisations.
- II.11 The CHAPS service provides efficient, settlement risk-free and irrevocable payments. As well as high-value, wholesale payments, CHAPS is also used for time-critical lower-value payments such as house purchases.

Changes to the RTGS and CHAPS services since the previous self-assessments

- II.12 The last year has seen a significant period of change for CHAPS and RTGS, as well as for the retail payment systems.
- II.13 First, in November 2017 responsibility for operating the CHAPS service transferred to the Bank from CHAPS Co, the previous private-sector operator. The Bank's decision to make this change was made following public consultation, which concluded that financial stability would be enhanced. The conclusion was endorsed by the Financial Policy Committee and met the recommendations made by the International Monetary Fund.⁶ The change was designed to enable the Bank, as the operator of the RTGS and CHAPS services, to operate effectively as an end-to-end systemic risk manager across the CHAPS payment system.
- II.14 Second, following the transfer of the CHAPS service to the Bank, we have undertaken a series of integration and transformation activities to deliver the intended benefits. These include:
- A new, enhanced and integrated governance framework for the RTGS and CHAPS services, headed by the new RTGS/CHAPS Board. The governance framework provides strategic leadership for the management, operation and future development of both services.
 - An integrated incident management framework spanning RTGS and CHAPS.
 - The integration of operational, analytical and risk teams as well as a strategy and governance 'hub' to support the Bank's operation of RTGS and CHAPS.

⁶ <http://www.imf.org/external/pubs/ft/scr/2016/cr16156.pdf>

- Increasingly integrated and enhanced arrangements for risk management. As of the assessment date of June 2018, a combined single interim framework aligns CHAPS to the Bank-wide risk management framework, and enables both a common language for articulating risks, and a set of common practices.
- Activities to develop our role as an end-to-end systemic risk management. This is a process of continuous improvement – building our understanding of the end-to-end system, assessing the risks, and determining how the Bank, and other key stakeholders in the CHAPS system can work to reduce these risks.
- Working with the wider Bank, including prudential supervisors, risk specialists, and cyber security experts, to draw on the depth and breadth of internal and external resources available to the Bank to inform our operation and risk management of the CHAPS service. For example, the Bank's operation of CHAPS can be informed by access to real-time payment and balance data which was not previously possible.

II.15 Third, we have significantly enhanced the external engagement for CHAPS and RTGS. The Bank undertakes regular engagement with the Direct Participants of CHAPS to seek feedback of the operation of the system. The Bank has also established a CHAPS Strategic Advisory Forum to provide a further feedback channel directly in to the Board. The Forum's external members are senior, experienced executives drawn from CHAPS Direct and Indirect Participants, as well as end-users. The Forum is chaired by an external member of RTGS/CHAPS Board. The RTGS Renewal Programme also continues with significant external engagement through its External Advisory Body, a range of working groups, and public consultation.

II.16 Fourth, the Bank has supported a continued increase in the number of CHAPS Direct Participants as well as directly-settling participants in the retail systems. This is alongside a significant increase in account holders in RTGS, reflecting continued growth to the Sterling Monetary Framework.

- In July 2017, the Bank announced that non-bank Payment Service Providers (NBPSPs) were eligible to apply for a settlement account in RTGS. Opening up direct RTGS access enables NBPSPs to compete on a more level playing field with banks, and to gain direct access to payment systems that require an RTGS settlement account. This reduces dependencies on bank competitors and potentially supports their ability to offer a wider range of payment services as well as having direct control over the quality of service provided to customers. In early 2018 the first two NBPSPs opened Settlement Accounts in RTGS for the purpose of settling

payment, one of whom has since also become a Direct Participant in CHAPS.

Further NBPSPs are in the pipeline for next year.

- ING, LCH Ltd and Elavon joined CHAPS as Direct Participants - reducing the level of tiering within the CHAPS system, and hence risks to financial stability.
- A number of small and/or challenger banks also gained access to the retail payment systems.
- 'Ring-fenced banks' must directly access all payment systems used⁷ - resulting in a number of additional participants across CHAPS, CREST and the retail systems that settle across accounts in RTGS.

Context of future changes to RTGS, CHAPS and the broader payments industry

II.17 The structure of UK payments continues to change significantly. Three developments are of particular importance:

- The ongoing RTGS Renewal Programme;
- The proposed move to a single UK Common Credit Message based on the ISO 20022 standard; and
- Changes to the governance and infrastructure of the UK's retail payments services.

RTGS infrastructure renewal

II.18 On 9 May 2017, the Bank published a Blueprint for RTGS renewal⁸. Renewing the service is necessary because the way payments are made has changed dramatically in recent years, reflecting changes in the needs of households and companies, changes in technology, and an evolving regulatory landscape. The Bank's vision is to develop an RTGS service which is fit for the future, increasing resilience and access, and offering wider interoperability, improved user functionality and strengthened end-to-end risk management of the UK's High Value Payment System.

II.19 The renewed RTGS service will be delivered through a multi-year programme of work. The Bank's approach to RTGS renewal is an open and collaborative effort with extensive

⁷ Under the Excluded Activities and Prohibitions Order (2014). The Order also specifies certain exemptions, where another bank in the same ring-fenced group is a member, alternative contingency arrangements exist, or where joining the payment system is prohibited or where the bank can demonstrate that joining the specific payment scheme would be disproportionate.

⁸ <http://www.bankofengland.co.uk/markets/Documents/paymentsystem/rtgsblueprint.pdf>

stakeholder engagement at all stages. As part of this, the Bank has established an External Advisory Body that includes a range of senior figures from the payment industry and other relevant stakeholders. The first meeting of the External Advisory Body was held on 19 July 2017, and it has convened a number of times since.

- II.20 Following publication of the Blueprint much progress has been made including: agreeing the scope of what the Programme will deliver, designing the overall technology solution, assessing the high level impact of the renewed service on our current processes and procedures, and importantly, how we will introduce the new RTGS service without disrupting the day-to-day running of RTGS given its critical importance to the UK economy. The next major phase of the Renewal Programme will see us continue to work with external partners and the current and prospective users of RTGS, to advance the design of the new service, and prepare for its implementation.

ISO 20022 Common Credit Message

- II.21 In June 2018, the Bank launched a joint consultation with Pay.UK on moving to the ISO 20022 payments messaging standard. It proposed that both entities adopt a standardised ISO 20022 'Common UK Credit Message' (CCM) in CHAPS (as part of the RTGS Renewal Programme) and the retail schemes operated by Pay.UK (as part of the New Payments Architecture). ISO 20022 is a globally-agreed and managed method for creating financial messaging standards which has an open standard, is network agnostic and will increase data carrying capacity with an improved structure.

- II.22 Realising benefits to the full, and preparing payments systems for the future, will require material changes not just by payment providers, but by many others across the payments chain, including some end-user companies and individuals. That will require close co-ordination across a wide range of separate bodies, over several years. The Bank and Pay.UK, as payment system operators, and the PSR, as economic regulator of payment systems, are committed to help deliver the broadest possible adoption of the standard. We will work closely together to minimise disruption and maximise the benefits for the United Kingdom. Following the assessment, the Bank and Pay.UK published a consultation response document in November 2018. They have jointly set up a Standards Advisory Panel to seek industry views on the adoption of ISO 20022, which will meet for the first time in early 2019.

Change in UK retail payments arrangements

- II.23 Pay.UK was incorporated in 2017 as the New Payment System Operator (NPSO) and is now responsible for four of the UK's retail payment systems – Bacs, Faster Payments, Cheque & Credit (paper), and the new Image Clearing Scheme for cheques. This follows the Payments Strategy Forum's strategy to create a new architecture for retail payments; simplify access to the market, improve end-user functionality and enhance safety and security.
- II.24 Pay.UK is responsible for the development of the New Payments Architecture and the safe and secure transition from the current systems to a shared retail payment infrastructure. The NPA is scheduled for implementation in the next few years, in line with the procurement and development process outlined by Pay.UK in October 2018.

How has the Bank assessed RTGS and CHAPS?

- II.25 The Bank's joint assessment of the RTGS and CHAPS services is a self-assessment. The assessment has been undertaken by the business area that operates and manages the delivery of the RTGS and CHAPS services, and has been reviewed by subject matter experts within the Bank. It is an input to the regular supervisory review undertaken by the Financial Market Infrastructure Directorate area of the Bank in its role as the non-statutory supervisor of the Bank's operation of CHAPS. The published version of the assessment has not been reviewed, undertaken or endorsed by the Bank in its capacity as prudential supervisor of FMIs.
- II.26 While RTGS is not a payment system, the RTGS aspects of the self-assessment has primarily been undertaken against the principles that apply to payment systems. For certain principles, a judgement has been made as to how they apply to the RTGS and CHAPS services – this is set out in the self-assessment where relevant.

What were the findings?

- II.27 The table below summarises the findings of the self-assessment.

Assessment category	Principle
Observed	Principles 1 – Legal basis, 4 – Credit risk, 5 – Collateral*, 7 – Liquidity**, 8 – Settlement finality, 9 – Money settlements, 13 – Participant-default rules and procedures, 15 – General business risk, 16 – Custody and investment risks*, 17 – Operational risk, 18 – Access and participation requirements, 19 – Tiered participation arrangements**, 21 – Efficiency and effectiveness, 22 – Communication procedures and standards and 23 – Disclosure of rules, key procedures, and market data.
Broadly observed	Principles 2 – Governance and 3 – Framework for the comprehensive management of risks.
Partly observed	Nil
Not observed	Nil
Not applicable	Principles 6 – Margin, 10 – Physical deliveries, 11 – Central securities depositories, 12 – Exchange-of-value settlement systems, 14 – Segregation and portability, 20 – FMI links and 24 – Disclosure of market data by trade repositories.

*Not applicable for CHAPS

**Not applicable for RTGS

II.40 Several principles do not apply to the RTGS or CHAPS services as the services do not have the characteristics of a central securities depository, a central counterparty or a trade repository.⁹ In addition, Principle 12 - Exchange-of-value settlement system does not apply as the Bank does not operate as such a system. Further explanation on these points is provided in the principle-by-principle narrative.

II.41 The Bank does not require liquidity to operate RTGS; therefore Principle 7-Liquidity risk is not applicable in relation to RTGS. Whilst the Bank takes on no liquidity risk as part of its operation of CHAPS, as a systemic risk manager the Bank monitors the extent to which liquidity risk arises between Direct Participants and seeks to mitigate it where possible and proportionate. Principle 7-Liquidity risk is therefore relevant to CHAPS but not RTGS. Similarly, tiered participation arrangements exist for access to CHAPS but not to RTGS, therefore Principle 19-Tiered participation is applicable to CHAPS only.

⁹ Principles 10 – Physical deliveries, 11 – Central securities depositories, 14 – Segregation and portability, 20 – FMI links and 24 – Disclosure of market data by trade repositories.

- II.42 Conversely, collateral (held by banks in RTGS form part of the Bank's balance sheet and the provision of intraday liquidity) is taken as part of the operation of RTGS but not CHAPS. Principle 5-Collateral and Principle 16-Custody and investment risks are therefore relevant to RTGS but not CHAPS.

Summary findings and scope for improvement

- II.43 Key findings under each theme are summarised below. Where relevant, the summaries highlight policy changes that have been announced but not yet delivered.

General organisation

- II.44 The Bank observes Principle 1-Legal basis. It broadly observes Principle 2-Governance and Principle 3-Framework for the comprehensive management of risks.
- II.45 The Bank has implemented appropriate and robust legal coverage for the RTGS and CHAPS services. The Bank draws on in-house legal experts and external legal services to produce legal documentation and to review any legal agreement that the Bank enters into.
- II.46 Responsibility for the CHAPS system transferred to the Bank in November 2017. A new, combined governance structure for RTGS and CHAPS was introduced at the same time. The revised governance arrangements for RTGS and CHAPS have been designed to meet best practice, where appropriate. The experience since November 2017 is that the structure in place is appropriate and working effectively. However, given the governance had been in place for just a few months at the time of the assessment, it is too early to demonstrate that the governance arrangements have a track record of consistently functioning as fully effective over an extended period of time. The Bank will continue to mature the governance arrangements, informed by a review of the Board's effectiveness that will be completed in early 2019.
- II.47 The RTGS/CHAPS Board determines the strategy for the management of and tolerance for risk. It takes the lead in setting a strong risk management culture and relies on a sound governance structure to ensure its risk management strategy is implemented through frameworks, policies and risk reporting. Enhancements will be implemented in phases over at least the next year.

II.48 One of the drivers behind transferring responsibility for CHAPS to the Bank was so that a single organisation (the Bank) could act as a fully effective end-to-end systemic risk manager. How we operate in this role continues to be enhanced, with the support of the CHAPS Direct Participants and the wider Bank. This will further improve our understanding of the end-to-end payment system, and enhance our ability to identify and manage systemic risks to the CHAPS system and financial stability.

II.49 Principle 2-Governance and Principle 3- Framework for the comprehensive management of risks are therefore both being rated as 'broadly observed' at this stage. This reflects that, whilst we believe that the structures are appropriate and have been operating effectively up to the point of assessment, more time is required to reach a mature self-assessment of the new governance and risk management arrangements.

Credit and liquidity risk management

II.50 The Bank observes Principle 4-Credit risk, Principle 5-Collateral, and Principle 7 – Liquidity risk. In running RTGS, the Bank takes only very limited credit risk through the provision of intraday liquidity against the very highest quality collateral supported by prudent margins. The Bank also takes minimal credit risk through the potential non-recovery of the RTGS or CHAPS tariff. The Bank takes on no liquidity risk in its operation of either of the RTGS or CHAPS services. However, as a systemic risk manager, the Bank monitors the extent to which liquidity risk arises within the CHAPS system and seeks to mitigate it where possible and proportionate.

Settlement

II.51 The Bank observes Principle 8–Settlement finality and Principle 9–Money settlements

II.52 The RTGS service provides settlement in real-time, and real-time settlement is used for CHAPS. All settlement across accounts in RTGS is in central bank money. CHAPS is a designated system under the Financial Markets and Insolvency (Settlement Finality) Regulations 1999 (SFR), which implemented the EU Settlement Finality Directive.

Default management

II.53 The Bank observes Principle 13-Participant-default rules and procedures. Actions the Bank can take if an account holder, including CHAPS Direct Participants, defaults are set out in

the RTGS Terms & Conditions (and associated CHAPS and CREST documents), supported by internal procedures. The likelihood and magnitude of credit losses are minimised and would not put the Bank's operation of the RTGS Service at risk.

General business and operational risk management

- II.54 The Bank observes Principle 15-General business risk, Principle 16- Custody and investment risks and Principle 17-Operational risk.
- II.55 The Bank carefully monitors, manages and recovers operating and investment costs associated with the RTGS and CHAPS services. The Bank adopts a risk-averse approach in relation to securities used to generate intraday liquidity for account holders.
- II.56 The Bank reduces and mitigates operational risks in order to provide a high degree of security, reliability and availability for RTGS and CHAPS. The Bank has comprehensive arrangements for business continuity and crisis management, based on a standard Gold, Silver and Bronze framework. A risk tolerance statement defines the nature and extent of risks (including operational risk) that the Bank is willing to accept for RTGS and CHAPS.
- II.57 The Bank introduced the Market Infrastructure Resiliency Service (MIRS) in 2014 as a contingency infrastructure for RTGS. MIRS is operated by SWIFT, with SWIFT's sites geographically remote from the Bank's own sites, and is technologically independent. The Bank undertakes a wide range of testing and exercises.

Access

- II.58 The Bank observes Principle 18–Access and participation requirements and Principle 19-Tiered participation arrangements.
- II.59 The Bank publishes and periodically reviews the access criteria for settlement accounts, taking due consideration of risks to its balance sheet. The Bank's policy on access to settlement accounts in RTGS was revised in July 2017 to enable access for NBPSPs.
- II.60 The access criteria for CHAPS are published as part of the CHAPS Reference Manual on the Bank's website and were also revised to enable access for NBPSPs. Additional information is available on the Bank's website and through private disclosure to applicants on the nature of the technical and operational arrangements.

II.61 The Bank has clear, published, tiering criteria for the CHAPS system. Payments data is regularly assessed against these criteria and the Bank considers what the appropriate course of action would be to reduce risks to the CHAPS system and wider financial stability. This may include activities to explore organisations moving from indirect to direct access.

Efficiency

II.62 The Bank observes Principle 21–Efficiency and effectiveness and Principle 22-Communication procedures and standards. The Bank prioritises the mitigation of risks to monetary and financial stability in its design and operation of the RTGS and CHAPS services. Wherever it can do so without compromising stability, the Bank seeks to provide value for money and functionality demanded by users. Messages to, and from, RTGS, including CHAPS settlement instructions, use SWIFT messaging formats. The Bank has consulted on moving to ISO 20022 for CHAPS as part of the renewed RTGS infrastructure.

Transparency

II.63 The Bank observes Principle 23 - Disclosure of rules, key procedures, and market data. The Bank publishes the RTGS Terms & Conditions, RTGS tariff and other information relating to RTGS, alongside the CHAPS Reference Manual and CHAPS tariff on its website. Certain confidential or systemically sensitive documents are only shared with account holders, CHAPS Direct Participants, and payment system operators.

Scope

II.64 The assessment reflects the RTGS and CHAPS services as of 30 June 2018.

II.65 The PFMI self-assessment is based on all the principles relevant to the Bank's RTGS and CHAPS services. Some principles are relevant only to characteristics associated with specific types of FMIs, and hence do not apply to one or both of the Bank's RTGS and CHAPS services. For example, Principle 24 – Disclosure of market data by trade repositories has not been assessed. In total, seven of the twenty-four Principles have not been assessed for either the RTGS or the CHAPS Services.¹⁰

¹⁰ Principles not assessed as they do not apply to either the RTGS or the CHAPS service are: Principles 6 – Margin; 10 – Physical deliveries; 11 – Central securities depositories; 12 – Exchange-of-value settlement systems; 14 – Segregation and portability; 20 – FMI links; and 24 – Disclosure of market data by trade repositories.

- II.66 Four principles are only relevant to either RTGS or CHAPS, but not both.
- Principle 5-Collateral and Principle 16-Custody and investment risks are only relevant to RTGS, as no collateral is taken in the operation of CHAPS.
 - Principle 7-Liquidity risk and Principle 19-Tiered participation arrangements are only for CHAPS; liquidity and tiering risks are not applicable to RTGS as it is not a payment system.
- II.67 The Bank has self-assessed itself against the remaining thirteen principles in relation to its operation of both the RTGS and CHAPS services.
- II.68 Some of these assessments have considered the two services separately, where discrete arrangements exist, such as the processes under Principle 13-Participant default arrangements.
- II.69 For other principles, such as Principle 2-Governance, largely integrated arrangements exist, leading to a joint assessment.
- II.70 The self-assessment includes an explanation of the scope and applicability of each of the self-assessed seventeen principles. Where relevant, the narrative also notes where the Bank, as operator of the RTGS service, supports CHAPS Direct Participants and payment system operators in their management of liquidity and tiering risks.
- II.71 A CPMI-IOSCO publication¹¹ outlining the application of the PFMI to central bank FMIs recognises and provides guidance for exceptions where PFMI are applied differently to central bank operators. It notes that nothing in the PFMI is intended to constrain certain central bank policies. The guidance has been used in this self-assessment. This is particularly relevant to principles such as Principle 5-Collateral, where the Bank's requirement for collateral provided to generate intra-day liquidity to be of the highest quality and liquidity restricts the type of collateral the Bank will accept.
- II.72 Where the Bank's operation of RTGS is being considered, the application of, and self-assessment against, the PFMI also takes into account the specific nature of the current RTGS service. RTGS is not a payment system itself – RTGS is infrastructure that permits the final settlement of obligations, arising from payments and securities transactions, across

¹¹ See <http://www.bis.org/cpmi/publ/d130.pdf>.

accounts in RTGS on a real-time gross or deferred net basis. In the UK, the arrangements that make up each of the payment systems aside from CHAPS are operated and managed by the private sector. For example, Euroclear UK and Ireland (EUI) manages the CREST service and there are a number of different operators of retail payment systems.

II.73 In terms of the RTGS service, the self-assessment captures the RTGS infrastructure and all of the accounts within it, the use of those accounts to hold reserves and undertake settlement, connections to RTGS under the control of the Bank – including the Enquiry Link service – and the provision of related services such as cash prefunding. The collateral pool arrangements provided to the paper cheque clearing system are not within scope: they are provided outside of RTGS. Nor is the Bank's collateral management system within scope of the RTGS Service (and hence the self-assessment), other than in respect of the crediting of RTGS accounts against collateral.

II.74 In terms of the CHAPS service, the self-assessment captures not only the Bank's own operations, but also the Bank's role as an end-to-end systemic risk manager. This means that in assessing the risks in the CHAPS system, it considers not only the risks arising to itself and that it causes in the payment system but also the end to end and systemic risks inherent in the system's operation. For example, the risks that arise within the CHAPS system from the potential actions or inaction of Direct Participants, Indirect Participants, the suppliers to those participants, and suppliers to the Bank itself. For instance the Bank takes on no liquidity risk from its operation of CHAPS and is a positive contributor to reducing liquidity risk to the system through the design of the system. However as a systemic risk manager, the Bank monitors the extent of liquidity risk within the system and actively takes steps to mitigate it, both on a proactive and reactive basis.

III Introduction

Responding institution: Bank of England.

Jurisdiction(s) in which RTGS and CHAPS operate: The RTGS and CHAPS services are operated within the UK in sterling. RTGS and CHAPS operate under the laws of England and Wales.

Authority(ies) regulating, supervising or overseeing RTGS and CHAPS: CHAPS (and those elements of RTGS that directly support CHAPS) are supervised, on a non-statutory basis, by the Bank's Financial Market Infrastructure Directorate. Supervision is conducted to the same standard as that applied to FMIs recognised by HM Treasury for statutory supervision.¹²

The CHAPS system remains designated by HM Treasury for regulation by the Payment Systems Regulator (PSR) which has statutory objectives focussed on promoting competition, innovation and the interests of service-users. The PSR does not have any regulatory powers over the Bank. However, continued designation preserves the PSR's regulatory powers over the payment service providers that participate in CHAPS.

RTGS is not a payment system. The Bank's management and operation of the RTGS Service, save from where it directly supports CHAPS, does not directly fall under any regulatory, supervisory or oversight framework for Financial Market Infrastructures (FMIs). Many of the payment system operators and other FMIs in the UK that directly or indirectly use the RTGS Service have been recognised by HM Treasury as systemically important and are therefore subject to statutory supervision by the Bank's Financial Market Infrastructure Directorate.

The date of this disclosure (i.e. the point of assessment) is 30 June 2018. It was published on 21 December 2018.

This disclosure can also be found at: <https://www.bankofengland.co.uk/payment-and-settlement>

For further information, please contact enquiries@bankofengland.co.uk

III.1 This self-assessment was carried out against the Principles for Financial Market Infrastructures (PFMIs)¹³ and is based on the methodology set out in the associated

¹² CHAPS, when operated by CHAPS Co, was previously recognised by HM Treasury and subject to statutory supervision under the Banking Act 2009 as a systemically important FMI.

¹³ See <http://www.bis.org/cpmi/publ/d101a.pdf>.

Disclosure Framework and Assessment Methodology.¹⁴ This is first joint self-assessment of the Bank's operation of both RTGS and CHAPS services. The Bank and CHAPS Co previously undertook separate self-assessments of the RTGS and CHAPS services respectively.

- III.2 In line with the requirements on other FMIs, the Bank, as operator of CHAPS, has submitted a version of this self-assessment to the Bank's FMI Directorate. This public disclosure has been revised to remove any information that is confidential to the Bank or external stakeholders including, but not limited to, information that is commercially sensitive, legally privileged or restricted for security reasons.
- III.3 The objective of publishing this self-assessment is to increase the transparency over the Bank's management of the RTGS and CHAPS services, and increase visibility over the associated governance, operations and risk management framework amongst a broad audience. The audience includes current and prospective RTGS account holders, payment system operators settling in RTGS, current and prospective CHAPS Direct and Indirect Participants, other market participants, authorities and the general public including those that use CHAPS payments. Better understanding of the activities of the Bank with regards to the provision of the RTGS and CHAPS services should support sound decision-making by various stakeholders. The assessment also serves to facilitate the implementation and ongoing observance of the PFMI's.
- III.4 This assessment was conducted by the Bank's Market Services Division. This is the area responsible for the day-to-day operation of the RTGS and CHAPS services. Subject matter experts with supervisory, risk, audit, legal and IT backgrounds were consulted and have provided internal challenge. The self-assessment was also reviewed, and the ratings agreed, by the RTGS/CHAPS Board.

¹⁴ See <http://www.bis.org/cpmi/publ/d106.pdf>.

IV. Service description

General background of RTGS and CHAPS services

- IV.1 The Real-Time Gross Settlement (RTGS) infrastructure is owned and operated by the Bank of England (the 'Bank'). It is an accounting system that allows institutions to hold cash at the Bank, and settle obligations to each other. 'Central bank money' (for sterling, primarily the money held in accounts at the Bank) is the ultimate secure and liquid asset, and therefore offers the lowest-risk way for financial institutions to meet their payment obligations.
- IV.2 The Bank is also the operator of CHAPS. CHAPS is a sterling same-day payments system that is used to settle high-value wholesale payments as well as time-critical, lower-value payments. The core infrastructure for the real-time settlement of CHAPS payments, in central bank money, is the Bank's RTGS infrastructure.
- IV.3 The Bank's mission is to promote the good of the people of the United Kingdom by maintaining monetary and financial stability. The Bank's delivery of the RTGS and CHAPS services primarily supports the Bank's mission in three ways:
- Holding of reserves balances in accounts in RTGS to eligible institutions (as defined in the Sterling Monetary Framework). These facilitate the transmission of monetary policy (as balances are remunerated at Bank Rate, as set by the Monetary Policy Committee). They also provide those institutions with access to central bank money to help manage their liquidity risks.
 - Provision of reserves, settlement and prefunding accounts to eligible institutions (as defined under the Bank's Settlement Account Policy). These can be used to settle the obligations arising from payments and securities transactions made by banks¹⁵ and other institutions' participation in sterling payment and settlement systems.
 - Provision of the CHAPS service, the UK's main payment system for settlement of high value and time-critical payments. This service eliminates settlement risk between CHAPS Direct Participants. The Bank acts as the end-to-end systemic risk manager for CHAPS with the objective of reducing risks to financial stability.
- IV.4 The Bank, through its operation of RTGS and CHAPS, also seeks to promote efficiency, innovation and competition in sterling payments, wherever that can be safely done without impairing stability.

¹⁵ Unless stated otherwise, references to banks include building societies.

Overview of the RTGS and CHAPS services

- IV.5 Institutions have accounts in RTGS so they can:
- participate in the Bank’s reserves scheme, under the Sterling Monetary Framework (SMF), which supports delivery of the Bank’s monetary policy decisions); and/or
 - settle obligations in any of the payment systems for which the Bank acts as settlement agent.
- IV.6 The Bank provides sterling settlement services for eight payment systems: Bacs, CHAPS, Cheque & Credit (paper and the Image Clearing System), CREST, Faster Payments, LINK and Visa. Around sixty institutions use their accounts in RTGS to settle in one or more payment systems.
- IV.7 A number of other FMI use direct or indirect access to CHAPS to complete the respective payment obligations. CLS Bank and LCH Limited are Direct Participants in CHAPS for this purpose. Central counterparties and some of their clearing members have relationships with various banks to access CHAPS indirectly.
- IV.8 Account holders in RTGS communicate with the RTGS infrastructure via SWIFT. Figure 1 provides a simplified illustration of some of the interlinkages between RTGS, CHAPS, settling participants and other FMIs.

Real-time gross settlement

- IV.9 The RTGS service forms an integral part of two systemically important payment systems: CHAPS and the payment arrangements embedded within CREST.
- IV.10 The Bank is the operator of CHAPS, the UK’s high-value payment system. Individual CHAPS settlement instructions are routed via the SWIFT network to RTGS and settled across the sending and receiving CHAPS Direct Participants’ accounts. Transactions settled using CHAPS include wholesale financial market, corporate, housing, government and financial market infrastructure transactions.
- IV.11 Through its provision of the CHAPS service, the Bank is responsible for managing the CHAPS system’s governance and rulebook and, as a central component of its responsibilities, managing risks across the end-to-end CHAPS system.
- IV.12 The UK’s securities settlement system (CREST) is operated and managed by Euroclear UK & Ireland (EUI). CREST settles UK securities such as gilts, equities and money market

instruments in sterling, euro and US dollars. The Bank provides settlement for sterling obligations. CREST functions on a Delivery versus Payment (DvP) basis with settlement risk eliminated as transactions between CREST settlement banks are settled with finality in real-time against segregated liquidity. The Bank also holds sterling prefunding to support CREST US dollar settlement arrangements.

Figure 1: Interlinkages between RTGS, CHAPS and Financial Market Infrastructures

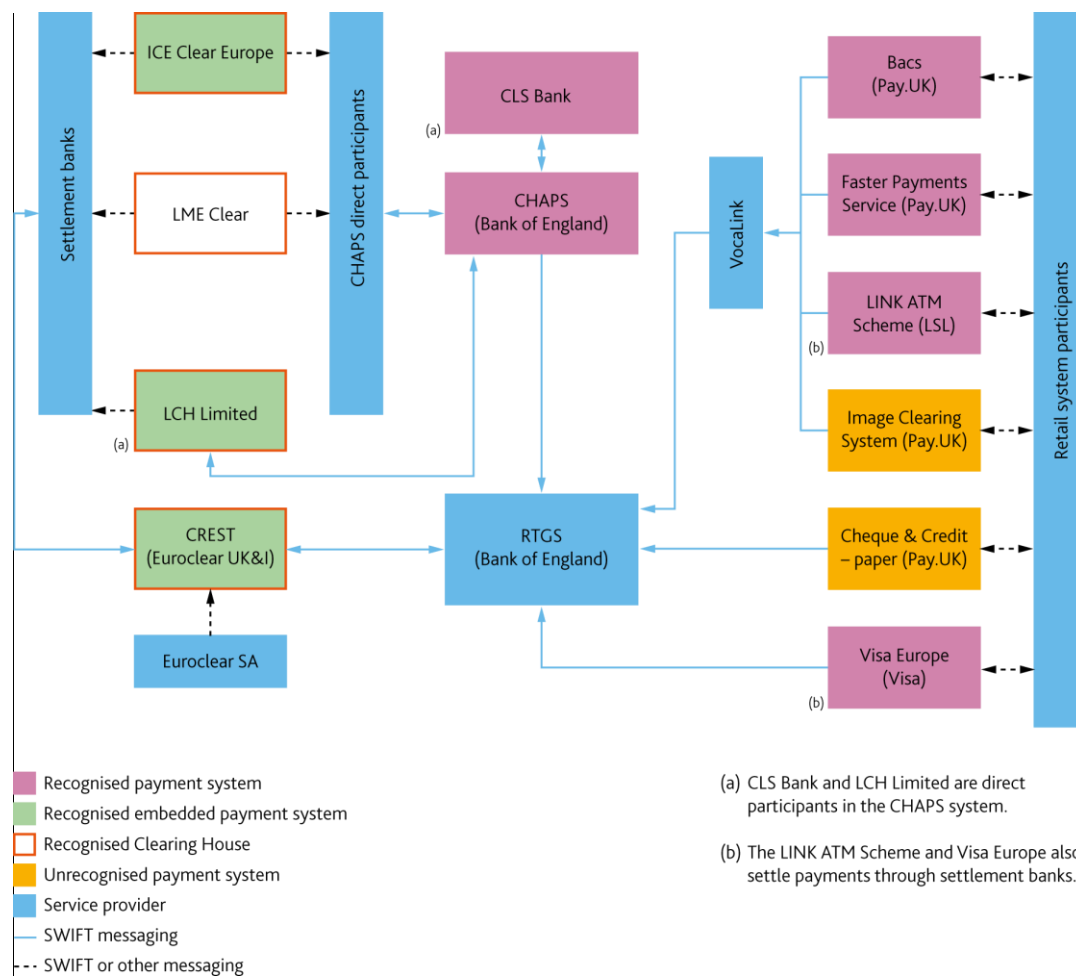

Deferred net settlement

IV.13 Accounts in RTGS are also used to settle the sterling net obligations arising from customer transactions for six retail payment systems. Each retail system settles on a multilateral, deferred net basis:

- Bacs: The UK's automated clearing house, processing Direct Debits (utility bills, subscriptions) and Direct Credits (salaries, pensions, benefits) across a three day cycle with net settlement taking place once a business day in RTGS.

- Cheque & Credit: Net settlement of cheques and paper credits¹⁶ takes place once a business day in RTGS. The clearing system operates on a three day cycle.
- The cheque-based Image Clearing System: Net settlement of cheques and paper credits based on an exchange of images, rather than paper, take places once a business day in RTGS. The clearing system operates on a two day cycle.
- Faster Payments: Faster Payments provides near real-time payments 24/7 and is used for standing orders, internet and telephone banking payments. Faster Payments settles net, three times every business day in RTGS.
- LINK: The UK's ATM network settles in 24 hour cycles; cycles that take place over the weekend and on public holidays all settle on a net basis on the following business day in RTGS.
- Visa: One of the card systems (for Visa debit, credit and prepaid cards) which settles in 24 hour cycles. Cycles that take place over the weekend and on public holidays all settle on a net basis on the following business day in RTGS.

IV.14 The Bank provides additional services in relation to Bacs, Faster Payments, Cheque & Credit and the Image Clearing System to help reduce, or eliminate credit risk between the direct settlement participants.

- For Bacs, Faster Payments and the Image Clearing System, direct settlement participants hold cash in special accounts to cover the maximum possible net debit positions they could reach (this is known as 'prefunding'). If a direct settlement participant defaults, the cash set aside can be used to complete settlement for the relevant system.
- For Cheque & Credit, the Bank manages a pool of collateral provided by direct settlement participants to cover a failure or significant delay in settling by one or more direct settlement participants.

IV.15 Figure 2 provides a simplified illustration of how accounts in RTGS are grouped and used. The illustration is for a participant which settles in the payment systems which settle across RTGS. CHAPS and the retail systems all settle from an account holder's primary reserves/settlement account. Cash for Bacs, Faster Payments and the Image Clearing System prefunding is held in separate accounts but forms part of an eligible institution's overall reserves balance, if applicable. CREST settlement is through a distinct account with liquidity moved to and from the primary reserves/settlement account each day.

¹⁶ The paper cheque & credit clearings are expected to be retired in 2019, following the completion of migration of cheques and credits to the Image Clearing System.

IV.16 For non-bank payment service providers, accounts must also be designated as either 'own funds' or 'client funds' given the legislative requirements for safeguarding of client funds. The account structure in RTGS has been designed to support the 'segregation method' where client funds are kept separately to those funds held by the relevant non-bank payment service provide in their own name.

IV.17 Further information on the different settlement models is set out in paragraphs IV.69 – IV.96.

Figure 2: Typical hierarchy of accounts in RTGS

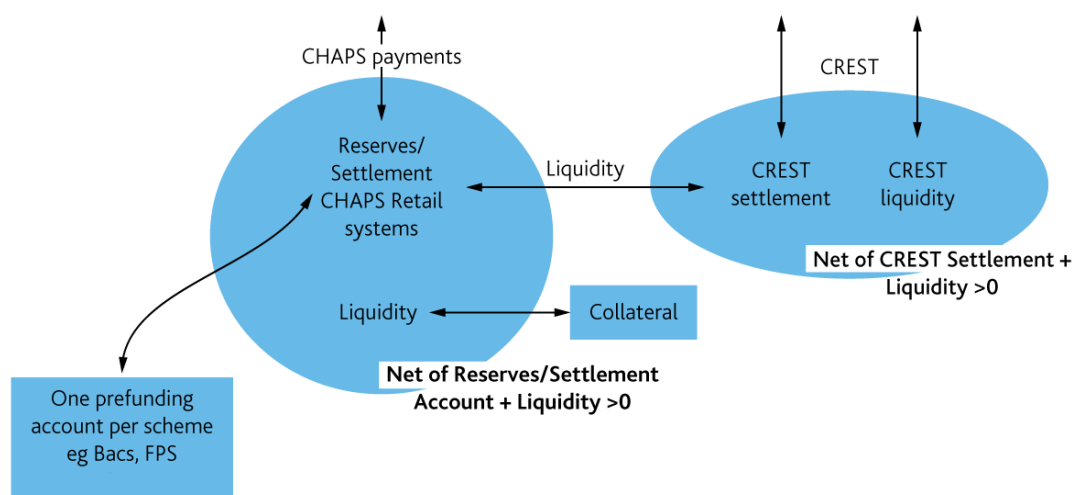

IV.18 An expanded explanation of the Bank's RTGS service has been published in the Bank's Quarterly Bulletin series.¹⁷

Key RTGS and CHAPS statistics

RTGS and CHAPS volume and value statistics

Table 1: Average daily RTGS and CHAPS settlement volumes and values

	2013	2014	2015	2016	2017
CHAPS values (£mn)	£277,229	£268,615	£270,400	£298,710	£333,661
CHAPS volumes	138,245	144,353	148,412	154,006	165,285
CREST DvP values (£mn)	£303,717	£274,257	£240,480	£220,970	£270,129
CREST DvP volumes	8,388	9,050	9,391	10,883	12,063
Faster Payments net values (£mn)	£586	£606	£663	£677	£775
Bacs net values (£mn)	£3,071	£3,122	£3,159	£3,193	£3,321
Cheque & Credit net values (£mn)	£211	£196	£190	£156	£137
LINK net values (£mn)	£249	£271	£294	£315	£324
Visa net values (£mn)	£1,144	£1,149	£1,425	£1,531	£1,776

Notes:

- All data are daily averages of transactions settled within the RTGS system.

¹⁷ See <https://www.bankofengland.co.uk/-/media/boe/files/quarterly-bulletin/2012/the-boes-real-time-gross-settlement-infrastructure.pdf>.

- CREST DvP activity in RTGS is measured by the debits applied to CREST settlement accounts at the end of each CREST settlement cycle, not the total volume or value of transactions in CREST itself.
- Retail payment system values represent the net value of each system's settlement across RTGS. Net settlement for retail payment systems takes place within defined clearing cycles at specific points during the RTGS operating day. Therefore, no volume data are available.
- Visa began settling its sterling net obligations across RTGS in November 2013.
- The cheque-based Image Clearing System started settling in RTGS from end-October 2017. The values in 2017 were negligible.

Participants

IV.19 At 30 September 2018, there were:

- 33 CHAPS Direct Participants;
- 21 CREST settlement banks;
- around 200 reserves account holders; and
- around half a dozen settlement account holders.

CHAPS trends

IV.20 CHAPS payments represent around 0.5% of UK total payment volumes, but 93% of sterling payment values (excluding internal payments). In 2017, CHAPS volumes grew by 6.9% to a new record of 41.7million, and CHAPS values grew by 11.3% to a new record of £84.1 trillion. Part of this increase is due to structural reform, which saw the Barclays and HSBC banking groups each join CHAPS for a second time to reflect the separation between their core, ring-fenced bank and other activities.

IV.21 Typically, around 75% of CHAPS by value relates to wholesale financial market transactions, while around the same proportion by volume relates to low-value, retail transactions. Peak days in CHAPS tend to be end-quarters, and can be particularly high around the end of March. The record value day in CHAPS, as of end-September 2018, is £468 billion on 20 December 2017. For volume, the record day is 29 March 2018 – with 320,034 – CHAPS payments worth £463 billion. This was the last working day of the quarter and the day before the Easter bank holiday weekend.

Figure 3: CHAPS volume and value profile 2017

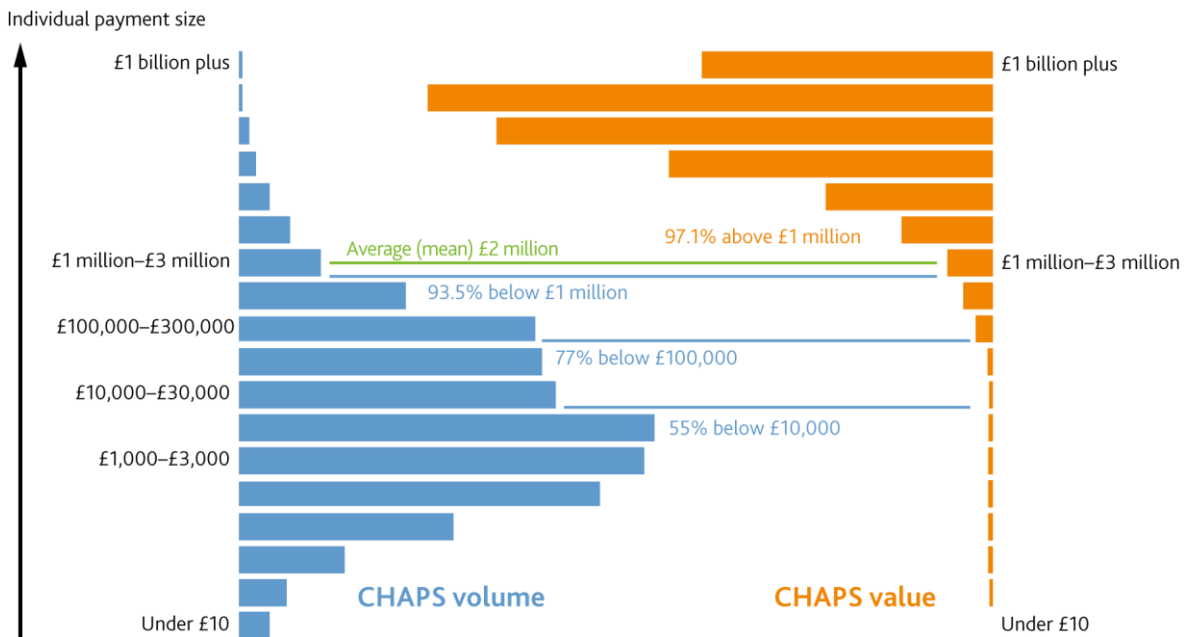

Figure 4: CHAPS values for the previous 12 months up to September 2018

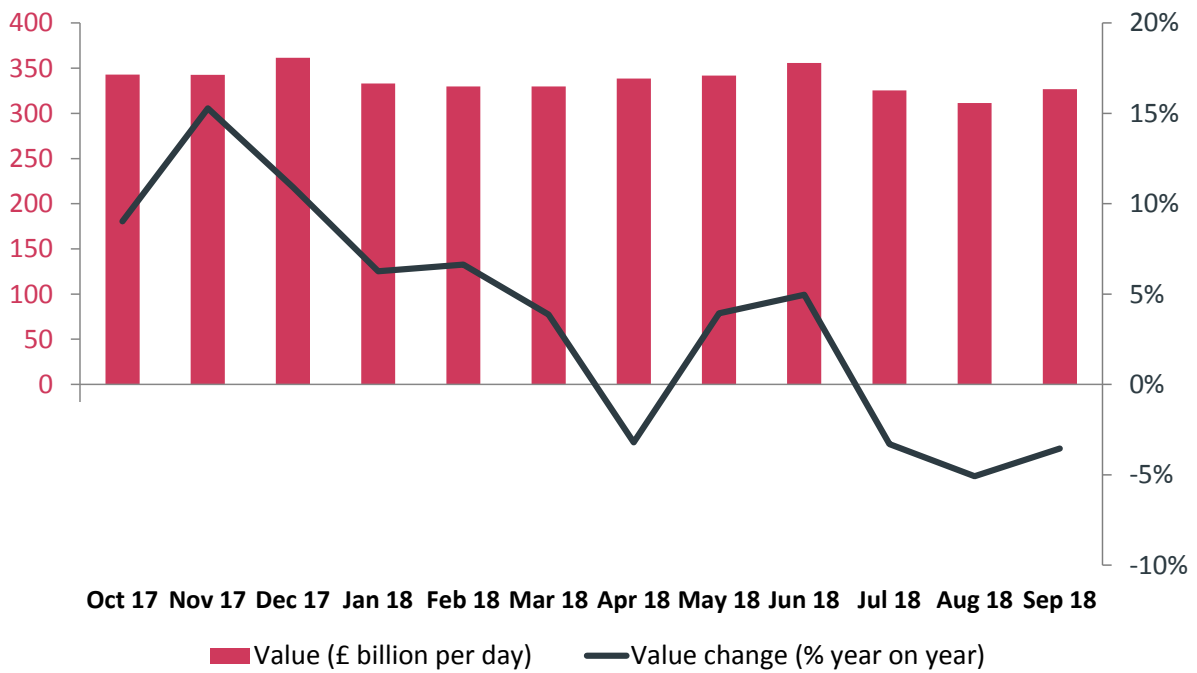
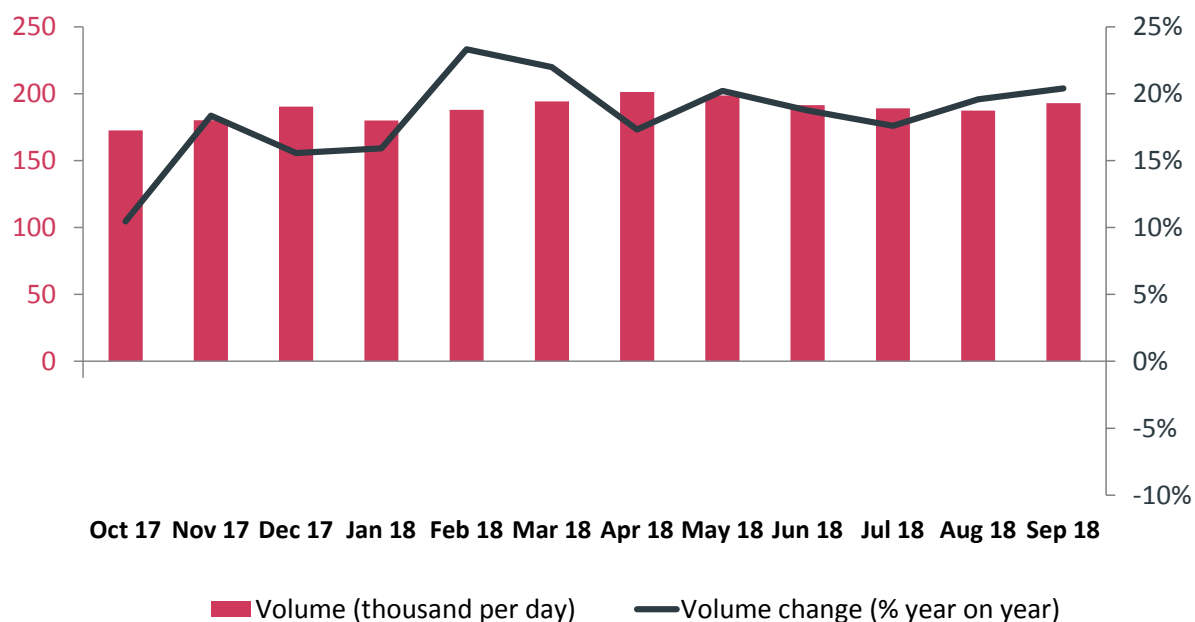

Figure 5: CHAPS volumes for the previous 12 months up to September 2018



Stock of Reserves

IV.22 As at end-February 2018, 86% of the Bank’s total consolidated balance sheet liabilities was held within the RTGS system, in the form of the banking systems’ reserves (£492bn on 28 February 2018).

Liquidity provision

IV.23 The settlement of CHAPS and CREST on a real-time gross basis means CHAPS Direct Participants and CREST settlement banks must have the ability to source intra-day liquidity from the Bank to supplement reserves if needed to fund outgoing payments, where eligible to participate in the SMF. On average in 2017, the Bank’s balance sheet increased by £48.4bn intra-day, of which £18.7bn of was provided for CHAPS intra-day liquidity and £29.7bn automatically generated via the auto-collateralised repo facility within CREST.

Overview of operational stability and resilience

IV.24 As the final record of sterling transfers, the operational stability and resilience of the RTGS system is of paramount importance to the Bank:

- Changes to RTGS are carefully considered and tested – the Bank engages on potential changes with the systems that settle in RTGS and relevant directly-settling participants of those systems.
- RTGS operates on fault-tolerant computer hardware which is replicated on a second site; and with the business operation also conducted on a split site basis.
- The Bank also has the option of using a third site and alternative technology in the form of SWIFT's 'Market Infrastructure Resiliency Service' (MIRS). MIRS is an additional contingency infrastructure that could be used in the event of a failure of its principal RTGS infrastructure. MIRS ensures that CHAPS payments continue to settle in the event of a disruption without resorting to a deferred net settlement model. It also facilitates the net settlement of CREST and the retail payment systems.

Table 2: Availability of RTGS Service in 2017¹⁸

Service Availability	Jan	Feb	Mar	Apr	May	Jun	Jul	Aug	Sep	Oct	Nov	Dec
RTGS infrastructure for 'urgent' CHAPS settlement (%)	100	100	99.76	100	100	100	100	100	100	100	100	100
RTGS infrastructure for 'non-urgent' CHAPS settlement (%)	100	100	99.64	100	100	100	100	99.62	100	100	100	100
Ability of RTGS and the RTGS-CREST link to support settlement in CREST (%)	100	100	100	100	100	100	100	100	100	100	100	100
Delays to net interbank settlement of retail payment systems (minutes)	0	0	0	0	0	0	0	0	0	0	0	0
RTGS Enquiry Link (%)	100	100	100	100	100	99.67	100	100	100	100	100	100

¹⁸ Historic data are published on the Bank's website. See <https://www.bankofengland.co.uk/payment-and-settlement/payment-and-settlement-statistics>

Table 3: Availability of RTGS Service in 2018

Service Availability	Jan	Feb	Mar	Apr	May	Jun	Jul	Aug	Sep
RTGS infrastructure for 'urgent' CHAPS settlement (%)	100	99.88	100	100	100	100	100	100	100
RTGS infrastructure for 'non-urgent' CHAPS settlement (%)	100	99.87	100	100	100	100	100	100	100
Ability of RTGS and the RTGS-CREST link to support settlement in CREST (%)	100	100	100	100	100	100	100	100	100
Delays to net interbank settlement of retail payment systems (minutes)	0	0	0	0	0	0	0	0	0
RTGS Enquiry Link (%)	100	100	100	100	100	100	100	100	100

Costs

IV.25 The Bank operates the RTGS and CHAPS services with a public objective to recover its costs fully over the medium term – typically a four year rolling horizon. Costs are recovered from those who use the RTGS and CHAPS service. Tariffs are set annually in accordance with principles agreed, and published, with relevant users to align income with budgeted cost. There are separate tariffs for CHAPS settlement, CREST DvP settlement, and each of the retail schemes. There is also a tariff for the CHAPS 'scheme' reflecting the additional costs of the Bank being the operator of CHAPS.

IV.26 There are a range of other costs for CHAPS Direct Participants. This includes one-off set-up costs, such as the cost of developing the necessary hardware, software and processes, and establishing sufficient expertise amongst staff. Ongoing costs may include the opportunity costs of providing collateral or holding liquid assets; maintenance of the necessary hardware and software; and staffing costs. Costs due to third parties include VocaLink charges for provision of the Extended Industry Sort Code Directory, SWIFT fees for CHAPS payment and advice messages and regulatory fees, including to the Payment Systems Regulator.

IV.27 The costs of RTGS renewal will be recovered through the tariff, once the new core ledger has been implemented. As in the past, the Bank will amortise these costs, but the scale of the programme means that the period of which costs are amortised is likely to be somewhat longer than usual.

Recent developments

Table 4: Major developments in RTGS and CHAPS in the last ten years:

Date	Development
May 2008	Automated net settlement introduced, enabling operators of retail payment systems to deliver settlement data to RTGS via SWIFT.
Sep 2010	Full FIN Copy Service implemented, copying the full CHAPS payment data to the RTGS Processor. This was a pre-requisite for business intelligence services.
Jan 2012	A business intelligence service for RTGS data (RTBI) became available to CHAPS Direct Participants, assisting them in meeting their regulatory reporting requirements.
Apr 2012	Tiering criteria introduced for CHAPS that sets out measures beyond which there is a presumption that an institution should move to direct access to reduce risk.
Apr 2013	Introduction of Liquidity Saving Mechanism (LSM) into RTGS, which identifies CHAPS payments to settle simultaneously to reduce use of intra-day liquidity.
May 2013	CHAPS Co (the previous operator of CHAPS) appointed its first independent chair to enhance the oversight and challenge to its operation of the CHAPS system.
Feb 2014	Introduction of Market Infrastructure Resiliency Service (MIRS) as a contingency RTGS infrastructure in the event of a failure of the principal RTGS infrastructure.
Oct 2014	Introduction of a new collateral management system that uses a collateral pooling model to manage the collateral for official operations and for intra-day liquidity.
Nov 2014	Extension of the eligibility criteria for membership of the reserves scheme to include central counterparties and broker dealers.
Jan 2015	CHAPS Co removed the 2% minimum contribution from Direct Participants, reducing costs of direct access for those with lower volumes.
Mar 2015	The RTGS Strategy Board was reconstituted from March 2015, in response to a recommendation made in Deloitte's independent review into the 2014 RTGS outage.
Sep 2015	Introduction of prefunding for Bacs and Faster Payments to address the settlement risk as a result of a build-up of obligations in the deferred net settlement systems.

- Jun 2016** The Bank extended the RTGS settlement day by one hour and forty minutes, with similar extensions implemented by the operators of the CHAPS and CREST systems.
- Feb 2017** The revised CHAPS Reference Manual was fully adopted, covering a set of Rules, Requirements and Procedures for the CHAPS system.
- May 2017** In its RTGS Blueprint, the Bank announced a number of significant policy changes and the intention to renew the RTGS service.
- Jul 2017** The Bank announced that non-bank payment service providers became eligible to apply for a settlement account in RTGS.
- Nov 2017** Responsibility for CHAPS transferred to the Bank, and a combined RTGS/CHAPS Board was set up to govern delivery of RTGS and CHAPS.

General organisation of the RTGS and CHAPS Services

Bank-wide governance and risk management

- IV.28 The Bank's governing body is its Board of Directors, known as the Court. The framework for governance and accountability is set by the Bank of England Act 1998, with some modifications made by the Banking Act 2009 and the Financial Services Act 2012. The Court is responsible for managing the Bank's affairs, other than the formulation of monetary policy which is the responsibility of the Monetary Policy Committee, the stability of the financial systems of the United Kingdom, which is the responsibility of the Financial Policy Committee and prudential regulation and supervision of banks, building societies, credit unions, insurers and major investment firms, which is the responsibility of the Prudential Regulation Committee (PRC).
- IV.29 The RTGS Renewal Committee is a sub-committee of Court responsible for overseeing the delivery of the RTGS renewal programme, and for making key decisions on the overall scope of the programme, the procurement and spending, within the overall budget envelope agreed by Court. It has six members, two external members from each of Court and the RTGS/CHAPS Board, as well the Deputy Governor for Markets & Banking and the Bank's Chief Operating Officer.
- IV.30 The executive management of the Bank lies with the Governors and Executive Directors. Court delegates the day-to-day management of the Bank to the Governor and through him to other members of the executive. But it reserves to itself a number of key decisions. These

'matters reserved to Court' are reviewed annually and are published on the Bank's website.¹⁹ The Governors serve as the Bank's top level executive team, and are responsible, in conjunction with the Bank's policy committees, for overseeing the fulfilment of the Bank's mission. Each Deputy Governor is assigned functional responsibility for a particular aspect of the Bank's work. The Executive Directors' Committee is accountable to Governors, the PRC (where applicable) and ultimately to Court.

RTGS- and CHAPS-specific governance and risk management

IV.31 The Bank's Deputy Governor for Markets and Banking has overall responsibility for the Bank's payment services operations, including the implementation of strategic changes, and the day-to-day- operation of, the RTGS and CHAPS services, under the Bank's internal application of the Senior Managers Regime.²⁰ The Executive Director for Banking, Payments and Financial Resilience oversees the operation and strategic development of the Bank's provision of payment system services, including the RTGS and CHAPS services. The Head of Market Services Division runs the RTGS and CHAPS services on a day-to-day basis.

IV.32 The Bank has dedicated, combined governance arrangements for the RTGS and CHAPS services with codified roles, compositions and reporting lines. Ultimately, the RTGS and CHAPS governance arrangements are accountable to the Governor, and through him, to the Bank's Court, the responsibilities for which are set out in legislation.

Key committees for the RTGS and CHAPS services

IV.33 The RTGS/CHAPS Board provides strategic leadership for the RTGS infrastructure and the CHAPS payment system. The Board operates within the Bank's wider governance structure, reporting to the Governor and Court. The Board supports the delivery of the Bank's mission to promote the good of the people of the United Kingdom by maintaining monetary and financial stability. It also seeks to promote efficiency, innovation and competition in sterling payments, wherever that can be safely done without impairing stability.

IV.34 The RTGS/CHAPS Board is chaired by the Deputy Governor for Markets and Banking. Members of the Board include four external appointees in order to provide additional challenge, broader experience and insight into the Bank's decision-making. Executive members include those with responsibility for the operation of the RTGS and CHAPS services as well as the Bank's Executive Directors for Technology and Markets. Non-

¹⁹ <https://www.bankofengland.co.uk/-/media/boe/files/about/legislation/matters-reserved-to-court.pdf>

²⁰ See <https://www.bankofengland.co.uk/-/media/boe/files/payments/smr.pdf>

member Board attendees are drawn from supporting functions across the Bank, including legal, risk and audit functions.

- IV.35 The Board is responsible for, in the context of the RTGS and CHAPS services, setting strategic aims, setting risk tolerances, reviewing the risk management frameworks and overseeing the risk profiles and risk mitigation, reviewing the audit programme and reviewing business continuity and crisis management.
- IV.36 The Board has delegated the monitoring of the RTGS and CHAPS risk management framework, risk tolerance and risk profiles to the RTGS/CHAPS Board Risk Committee. The Risk Committee has five members – two external, and three executive members.
- IV.37 The career experience of the external members can raise the possibility that individuals may have commercial interests which could give rise to a potential conflict. The Board has robust procedures in place to manage such conflicts to ensure the integrity and impartiality of the Board's decision-making.
- IV.38 The Bank also has a number of executive committees as part of the RTGS/CHAPS governance arrangements. This includes committees on risk, change and operations and input from other parts of the Bank including technology and risk functions. The RTGS Renewal programme has a parallel executive governance structure.

Stakeholder engagement

- IV.39 As operator of the RTGS and CHAPS services, the Bank has two-way engagement with CHAPS Direct Participants to seek views from them and to respond to their needs/interests, The Bank engages both through one-on-one meetings, and a range of forums, in some cases drawing in views from outside the Direct Participant population as well. Topics covered in multilateral forums include strategic matters, operations, technical change and testing. Thematic forums may also be held periodically on risk, security and liquidity.
- IV.40 The Bank also hosts a CHAPS Strategic Advisory Forum, which is a small, focussed and senior group to discuss, and provide feedback and advice on, the strategic direction of CHAPS with the Bank. It is chaired by one of the external members of the RTGS/CHAPS Board. Members are drawn from banks, other financial institutions, payment service providers and end-users.

- IV.41 The Bank also engages regularly with the operators of CREST and the retail systems that settle in RTGS in respect of the settlement services provided. This includes on the allocation of on-boarding slots for new participants to their systems, technical change, and the prefunding service for certain retail systems.
- IV.42 The RTGS Renewal programme has a dedicated set of arrangements for stakeholder engagement, including a senior External Advisory Body and Standards Advisory Panel. There are also a number of thematic and supporting working groups covering topics including transition as well as data and interoperability for ISO 20022 messaging.
- IV.43 The External Advisory Body represents a broad range of interests including CHAPS Direct Participants, Pay.UK, and a number of trade associations. The Standards Advisory Panel, jointly run with Pay.UK, will provide senior input on the implementation of ISO 20022 for CHAPS and Pay.UK's retail systems, as well as other relevant payments standards.

Legal framework

- IV.44 The Bank articulates the legal basis for its activities in legal documents that are made readily available to relevant stakeholders. The documents are governed by, and enforceable under English Law. Figure 6 sets out a summary of the legal arrangements in relation to RTGS and CHAPS.
- IV.45 For RTGS this includes: RTGS Account Mandate Terms and Conditions; multilateral agreements between the Bank, payment system operators and directly-settling participant(s) (typically owned by the operator, for example, the prefunding arrangements for Bacs and Faster Payments); and bilateral agreements with the payment system operators.
- IV.46 Specifically for CHAPS, each CHAPS Direct Participant also enters into a CHAPS Participation Agreement and undertakes to comply with the CHAPS rules, CHAPS Reference Manual and other relevant documents.
- IV.47 In addition to the above, where an institution wishes to participate in the Bank's Sterling Monetary Framework (which has its own eligibility criteria) and have a reserves account, it is required to sign up to the Sterling Monetary Framework Terms & Conditions which govern, amongst other things, the provision of collateral to cover any RTGS exposures.

Access criteria

- IV.48 To be eligible for direct access to CHAPS, an organisation must hold a reserves or settlement account at the Bank; be a participant within the definition set out in the Financial Markets and Insolvency (Settlement Finality) Regulations 1999; satisfy various security and resilience arrangements through a standard attestation process; and comply with the CHAPS Reference Manual. Applicants outside England & Wales must also provide information about company status and settlement finality through a legal opinion.
- IV.49 Access to reserves accounts is governed under the Sterling Monetary Framework's Red Book. Eligibility for settlement accounts and services are set out in the Bank's Settlement Account Policy. Institutions eligible for access to settlement accounts include banks, building societies, broker-dealers, CCPs, other Financial Market Infrastructures, and authorised non-bank payment service providers (electronic money institutions and payment institutions). In some cases, access is only possible for institutions that also participate in the Sterling Monetary Framework. Non-bank payment service providers require a non-objection from the Financial Conduct Authority following a supervisory assessment before being granted access to a settlement account by the Bank.
- IV.50 Applicants for settlement accounts must also be, or apply, to be a settlement participant in one of the payment systems that settles across accounts in RTGS. Institutions must also have the operational capacity to participate in and efficiently settle transactions in RTGS.
- IV.51 The legal documentation also sets out the steps that the Bank would take in non-routine events, including disablement and termination of accounts. The Bank has ultimate discretion to make unilateral changes if necessary for the UK's financial stability. As part of the central bank, the Bank, as operator of RTGS and CHAPS, works closely with other parts of the Bank in the event that an RTGS account holder is subject to resolution.

Figure 6: Legal documentation framework for services provided to payment system operators and their directly-settling participants

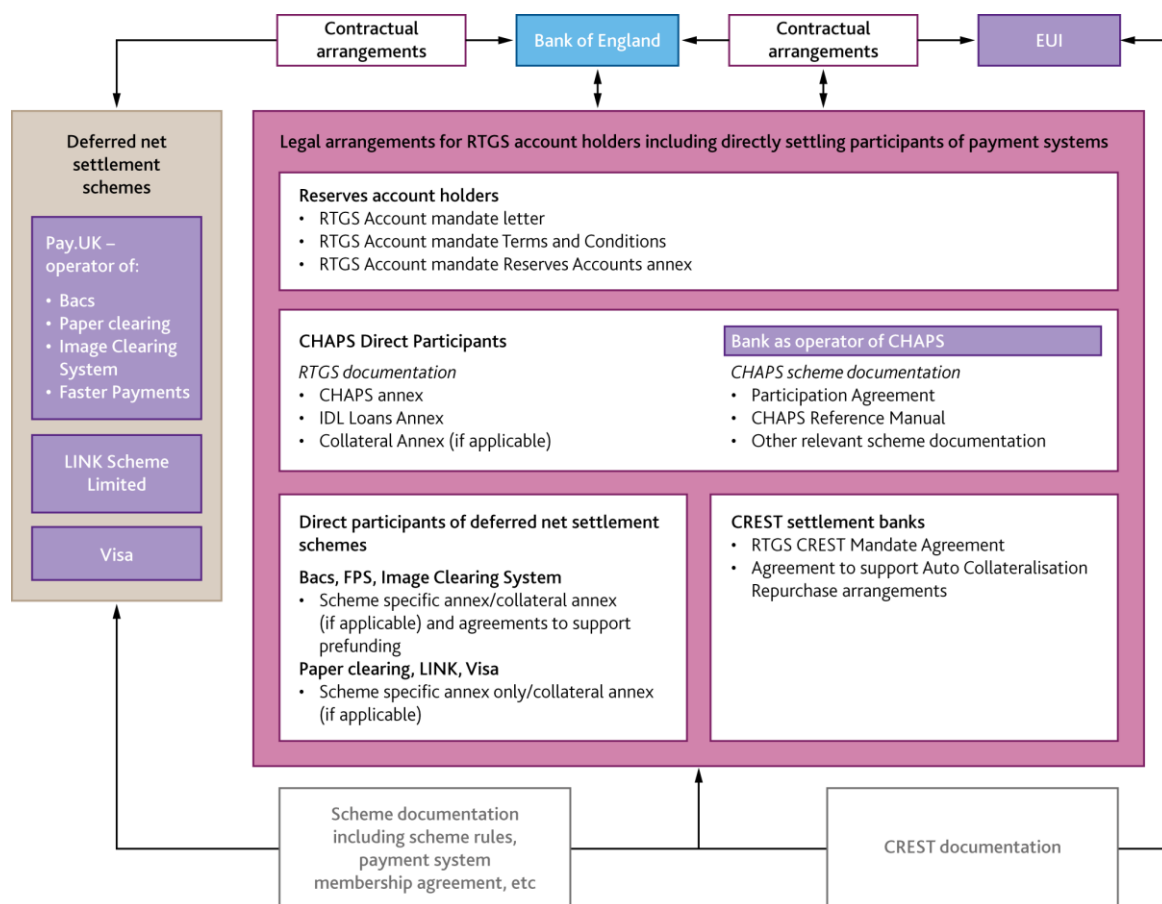

Regulatory framework

IV.52 The Bank’s management and operation of the RTGS service does not fall under any regulatory, supervisory or oversight framework for FMIs. It is, however, subject to the Bank’s internal governance arrangements.

IV.53 The Bank’s management and operation of CHAPS is subject to arms-length supervision, on a non-statutory basis, to the same standards applied to other systemically important payment systems that have been recognised.²¹ The Bank’s supervisory and operational areas sit in separate directorates, which report into different Deputy Governors. The Bank’s supervisory role is undertaken by the Bank’s Financial Market Infrastructure Directorate. This directorate undertakes an annual assessment of CHAPS against the Bank’s supervisory risk framework and assessing proposed material changes to business models or risk profiles to

²¹ In November 2017, the CHAPS system was de-recognised as a recognised payment system under the Banking Act 2009.

ensure that such changes do not increase risks to financial stability. There are also periodic reporting requirements and a programme of regulatory supervisory meetings and core assurance reviews. Both functions provide regular updates to the Bank's Financial Policy Committee.

- IV.54 The CHAPS system continues to be designated for settlement finality purposes by the Bank, as the relevant designating authority under the Financial Markets and Insolvency (Settlement Finality) Regulations 1999.
- IV.55 Many of the payment system operators and other FMI's in the UK that directly or indirectly use the RTGS Service are subject to statutory supervision by the Bank's Financial Market Infrastructure Directorate.
- IV.56 In the UK, the Payment Systems Regulator has objectives to promote competition, innovation and the interests of service-users in relation to payment systems. The CHAPS system continues to be designated under the Financial Services (Banking Reform) Act 2013. While the Payment Systems Regulator's regulatory powers do not apply to the Bank as either the operator of, or infrastructure provider to, the CHAPS system, the Payment Systems Regulator has regulatory powers over payment service providers who participate in the CHAPS system. The Payment Systems Regulator is also one of the UK's sectoral competition regulators, having concurrent competition powers with the Competition and Markets Authority.

System design and operations

- IV.57 The main technical features of the RTGS service are the RTGS processor and the Enquiry Link service.
- IV.58 The RTGS processor (or central system) is host to all the accounts held in RTGS and carries out all the postings made to those accounts. All payment messages pass through a validation process on reaching the RTGS processor, where the RTGS processor checks that the payment is valid and that it is not a duplicate.
- IV.59 The RTGS processor also has:
- an interface with the SWIFT network to receive settlement instructions (and send confirmations);
 - a link to the CREST system, to support the real-time DvP settlement process; and

- an interface with the Bank's collateral system, to enable accounts to be credited with intra-day liquidity secured by collateral.

IV.60 All account holders have access to the browser-based Enquiry Link service which is operated by the Bank. This enables account holders to monitor activity on, and receive information about, their account(s) in the RTGS processor, and in certain circumstances to transfer funds between accounts. Payment system operators that use cash prefunding also have access through the Enquiry Link.

IV.61 The key components of the CHAPS system are: SWIFT Fin Copy messaging which connects the CHAPS Direct Participants and the Bank; the necessary interfaces for the CHAPS Direct Participants and the Bank to connect to SWIFT; the Bank's RTGS processor which holds accounts for each CHAPS Direct Participant; and the browser-based Enquiry Link service.

IV.62 Within the RTGS processor is a central scheduler through which all CHAPS settlement instructions have to pass before actual settlement. CHAPS Direct Participants use the central scheduler for queue management. This includes controlling the rate and order in which their instructions proceed to settlement, and distinguishing between urgent and non-urgent CHAPS payments. CHAPS Direct Participants use the Enquiry Link to manage their accounts, including for queue management.

IV.63 More broadly, CHAPS Direct Participants maintain their own infrastructure to manage the accounts and other services they provide to their customers. End-users and indirect participants can initiate CHAPS payments through a number of channels, including the SWIFT FIN network, online banking products, branch networks, and written instructions/fax messages.

Reserves and settlement accounts²²

IV.64 Reserves accounts in RTGS are effectively sterling current accounts for Sterling Monetary Framework participants. As the balances constitute a form of central bank money, they are among the safest assets a financial institution can hold. They are the ultimate means of payment between financial institutions. Whenever payments are made between the

²² The special, segregated, accounts used for prefunding in Bacs, Faster Payments and the cheque-based Image Clearing System are subject to different arrangements, see IV.95-IV.96.

accounts of customers at different financial institutions, they are ultimately settled by transferring central bank money (reserves) between the reserves accounts of those banks.

- IV.65 Reserves balances can be varied freely to meet day-to-day liquidity needs, for example, to accommodate unexpected end-of-day payment flows. In this way, reserves balances can be used as a liquidity buffer. The funds held in reserves accounts are considered liquid assets for the purpose of the PRA's liquidity requirements. All reserves account balances earn Bank Rate.
- IV.66 Settlement accounts exist in the context of payment system membership. The same account may be used to settle the obligations from several payment systems, and may also be used for non-settlement purposes. An institution only holds a settlement account at the Bank where it is a member of one or more payment systems for which the Bank acts as Settlement Service Provider. Eligible institutions wishing to become direct participants in a payment system may apply for membership of that system, including CHAPS, simultaneously with their application for an account at the Bank.
- IV.67 For banks, building societies, CCPs and designated investment firms ('broker-dealers'), reserves accounts are also used as settlement accounts.
- IV.68 Some institutions, such as certain financial market infrastructures and non-bank payment service providers (NBPSPs), may be eligible for a settlement account but not a reserves account under the Sterling Monetary Framework. The eligible criteria for settlement accounts are set out in the Bank's Settlement Account Policy. The Bank extended the option of direct access to NBPSPs to enable broader access to sterling payment systems. This means that electronic money institutions and payment institutions authorised by the FCA²³ are now eligible to apply for settlement accounts with the Bank. They are not, however, eligible to participate in SMF and do not have access to reserves accounts or intraday liquidity. As they do not hold reserves accounts, settlement account balances are not remunerated.²⁴ NBPSPs are also eligible for direct access to CHAPS.

CHAPS settlement

²³ As defined in the Electronic Money Regulations 2011 and the Payment Services Regulations 2009 respectively. For further information on non-Bank PSPs see page 12 of the Blueprint <https://www.bankofengland.co.uk/-/media/boe/files/payments/a-blueprint-for-a-new-rtgs-service-for-the-uk.pdf>

²⁴ Any overnight balances on prefunding accounts will be remunerated.

- IV.69 The Bank provides same-day settlement for CHAPS payments made between 6:00 and 18:00 (with the ability to extend to 20:00 in contingency).²⁵ Settlement can occur at any point during this period but is subject to constraints controlled by the relevant account holders, such as available liquidity, and subject to account holders' exposure limits. CHAPS Direct Participants settle their own and indirect participants' CHAPS payments across accounts in RTGS.
- IV.70 Individual CHAPS payment instructions are routed via the SWIFT network to the RTGS system and settled across the sending and receiving CHAPS Direct Participants' settlement accounts. The message from the sending bank is stored within SWIFT FIN Copy while a full copy of the message is sent to the Bank for settlement. Once the payment is settled in RTGS with finality (sending bank's account debited, receiving bank's account credited), a confirmed is returned to SWIFT and the full payment message is then forwarded on to the receiving bank who then processes the payment as required in its own systems. Figure 7 illustrates this process.
- IV.71 Each CHAPS Direct Participant provides liquidity to support the timely settlement of CHAPS payments in RTGS. Liquidity is primarily provided by holding balances on a reserves/settlement account, and can be supplemented through the provision of intra-day liquidity where eligible to receive.

²⁵ The end-of-day was 16:20 until 17 June 2016.

Figure 7: CHAPS settlement

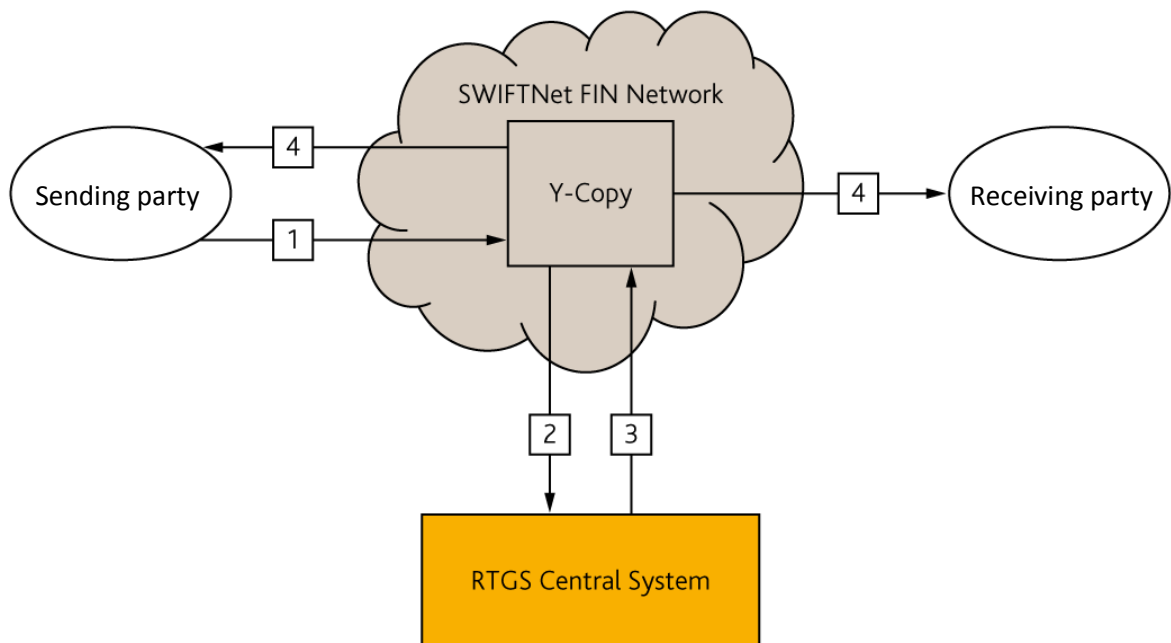

- 1 Payment instruction
- 2 Settlement request (full payment message)
- 3 Settlement confirmation
- 4 Payment/sender notification

IV.72 Since mid-April 2013, the Bank has provided a Liquidity Saving Mechanism (LSM) within RTGS. This LSM contains the central scheduler that enables the CHAPS Direct Participants to manage their payment flows centrally. In particular, they can decide whether CHAPS payments should settle via 'urgent' or 'non-urgent' streams. RTGS settles urgent CHAPS payments one at a time and in much the same way as it has since RTGS was first introduced. However, every few minutes the LSM suspends urgent payment processing and switches to a 'matching cycle' that, through the use of algorithms, matches and then simultaneously settles batches of offsetting non-urgent payments. Offsetting payments still settle gross from a legal standpoint but the simultaneous nature of the settlement means that banks economise on the use of liquidity.

CHAPS payment system management

IV.73 The CHAPS system is governed by rules, requirements and procedures which collectively set out the obligations and requirements that a CHAPS Direct Participant must meet, and

continue to comply with. These are contained in the CHAPS Reference Manual, the CHAPS Operational Reference Manual and the CHAPS Technical Reference Manual.

- IV.74 The Bank operates a 'trust and verify' approach which requires CHAPS Direct Participants to self-certify that they adhere to the relevant obligations and requirements. This is supported by additional participant assurance where the Bank seeks evidence of compliance, under a risk-based approach, with a 'consequence management' framework to manage non-compliances.
- IV.75 The CHAPS rules, as set out in the CHAPS Reference Manual, describe the key obligations for Direct Participants that help the Bank to identify, monitor, measure and/or manage material risks to the CHAPS system or the wider payments and financial eco- system as well as matters that have a significant effect on the efficiency or effectiveness of the CHAPS system.
- IV.76 The rules include: access criteria that institutions must meet, and continue to comply with, in order to access CHAPS directly; definitions for the point of entry, irrevocability and finality for CHAPS payment messages; and obligations and requirements in relation to events of default, voluntary withdrawal from the CHAPS system, as well as the arrangements for suspension or exclusion from the CHAPS system as deemed necessary by the Bank.
- IV.77 The principal function of the CHAPS participation requirements is to provide more granular detail underneath the CHAPS rules so that, taken collectively with the rules, the requirements can support the Bank in maintaining the security, integrity and reputation of the CHAPS system. The CHAPS procedures describe key elements of the CHAPS system's design and operations as well as describing certain key risks and controls.
- IV.78 Given the significance that tiering and throughput play in helping the Bank to monitor, manage and mitigate system and other risk, a review process, as outlined in the CHAPS Reference Manual, is available to current and prospective CHAPS Direct Participants should they wish to challenge a decision made by the Bank in these respects. Additionally, the Bank undertakes to seek input from CHAPS Direct Participants when making significant changes to the CHAPS Reference Manual.
- IV.79 The Bank defines a small number of categories to help to differentiate, in an objective manner, the inherent risks that CHAPS Direct Participants pose to the CHAPS system and wider financial stability. Categorisation is risk-based and takes into account factors including

values, volumes and the type of institution. There are currently four categories: Category 0 is for central banks; and Categories 1 – 3 are for all other types of participants. The participation requirements of less systemic CHAPS Direct Participants are less onerous, in places, to reflect the lower risk posed to the CHAPS system.

IV.80 Key areas of risk covered by the CHAPS Reference Manual are:

- Tiering: Under the CHAPS rules, the Bank may withdraw consent for a direct participant to provide access to CHAPS for an indirect participant if the indirect participant's average daily payment activities exceed either (i) 2% of the average total CHAPS payment activity, by value, or (ii) 40% of the average daily value of its direct participant's own payments. The Bank takes into account whether there are sufficient mitigating circumstances to address the financial and operational risks. One medium term mitigant is for the relevant indirect participant to move to accessing the CHAPS system directly.
- Throughput: Under the CHAPS throughput criteria, certain CHAPS Direct Participants are expected to settle 50% of payments, by value, by 12pm; 75% by 3pm; and 90% by 5pm. The rule seeks to ensure that payments should not be unnecessarily delayed in order to gain a disproportionate liquidity advantage. Submitting payments in a timely manner also mitigates operational risks associated with outages towards the end of the settlement day.
- Operational risk: Various expectations to reduce operational risk including for larger participants to maintain appropriately resilient and security arrangements including through management of third party service providers, and maintaining a tertiary solution for access to the CHAPS system.

IV.81 The Bank undertakes assurance against the obligations and requirements that Direct Participants are subject to under the CHAPS Reference Manual. All CHAPS Direct Participants must submit a self-certification of compliance annually. In addition, the Bank asks a series of questions based around the obligations set out in the CHAPS Reference Manual. The questions are risk-based and may vary between Direct Participants based on historic performance and the risks posed to the CHAPS system. The Bank also feeds in other information from verification activities such as site visits, as well as post-incident reviews.

IV.82 In addition to the self-certification and assurance activities, the Bank also collects a number of performance metrics. These include, for example, measures in relation to incidents, participation in testing, and whether any applicable throughput criteria are met.

- IV.83 The Bank's consequence management framework for the CHAPS system defines a number of actions that the Bank can take if a CHAPS Direct Participant's fails to comply with the relevant obligations and requirements. The Bank's response will depend on the level and severity of the associated risk. Where remediation is required, the 'service improvement plan' will be agreed with the relevant Direct Participant. Ultimately, the Bank may suspend or exclude a CHAPS Direct Participant from the CHAPS system in the event that the CHAPS Direct Participant threatens security, integrity or reputation of the CHAPS system.
- IV.84 The Bank works with CHAPS Direct Participants using standard incident and problem management processes. The Bank seeks to understand the root cause of any incidents and to drive down risk, and the likelihood of incidents, through sharing learnings from incidents. The Bank maintains a number of incident guides and playbooks, with a structured approach to communicating with CHAPS Direct Participants in the event of incidents.

DvP settlement for CREST

- IV.85 CREST is the UK's securities settlement system, operated by Euroclear UK & Ireland, which since November 2001 has provided real-time cash against securities settlement (referred to as 'Delivery versus Payment' or DvP) for its members. The CREST system settles securities transactions in a series of very high-frequency cycles through the day; after each cycle the Bank's RTGS system is advised of the debits and credits to be made to the CREST settlement banks' accounts in central bank money as a result of the settlement activity performed by CREST in that cycle.
- IV.86 The accounts in RTGS used for CREST settlement hold zero balances overnight; CREST settlement banks transfer funds each morning from their primary reserves/settlement account into their CREST account, and at the end of the CREST day, balances are automatically swept back up to the primary reserves/settlement account.
- IV.87 The settlement instructions to CREST settlement banks' accounts are underpinned by irrevocable and unconditional undertakings by the Bank to debit the paying CREST settlement bank in RTGS and credit the payee CREST settlement bank in RTGS.²⁶ In the unlikely event that a CREST software error creates an overdraft in RTGS, CREST

²⁶ See Chapter 6 of EUI's CREST Reference manual for further information: [https://my.euroclear.com/dam/EUI/Legal information/CREST-Reference-Manual.pdf](https://my.euroclear.com/dam/EUI/Legal%20information/CREST-Reference-Manual.pdf) (click 'Access as a guest').

settlement is suspended while the overdrawn account holder covers the overdraft. If it is unable, the Bank may invoke the Operational Error Lending Scheme (OELS) to ensure that any credit risk incurred from such an error is mitigated. Under OELS, account holders that are prematurely enriched due to an operational error may temporarily lend an equivalent amount of liquidity back to the 'overdrawn' CREST settlement bank on an unsecured intra-day basis.

- IV.88 There are several thousand CREST members, all with securities and cash accounts in the CREST system. Every CREST member must have a banking relationship with one or more CREST settlement banks. This relationship is reflected in the members' Cash Memorandum Accounts (CMAs) within CREST – against which all cash payments and receipts in respect of securities-related transactions are posted. Settlement banks set secured and unsecured credit caps to the CMAs of the CREST members that they represent, and which the CREST system operates on the settlement banks' behalf through the CREST business day.
- IV.89 CREST settlement accounts in RTGS have zero balances overnight. Before the start of CREST settlement each morning (and the sending of the first liquidity 'earmark' to CREST), settlement banks transfer funds to their CREST settlement accounts. During the day (between settlement cycles), settlement banks can add to or reduce the balance on their CREST settlement accounts. At the end of the CREST day, balances are automatically swept back up to the primary reserves/settlement account. Figure 5 illustrates this process.

Figure 8: CREST settlement

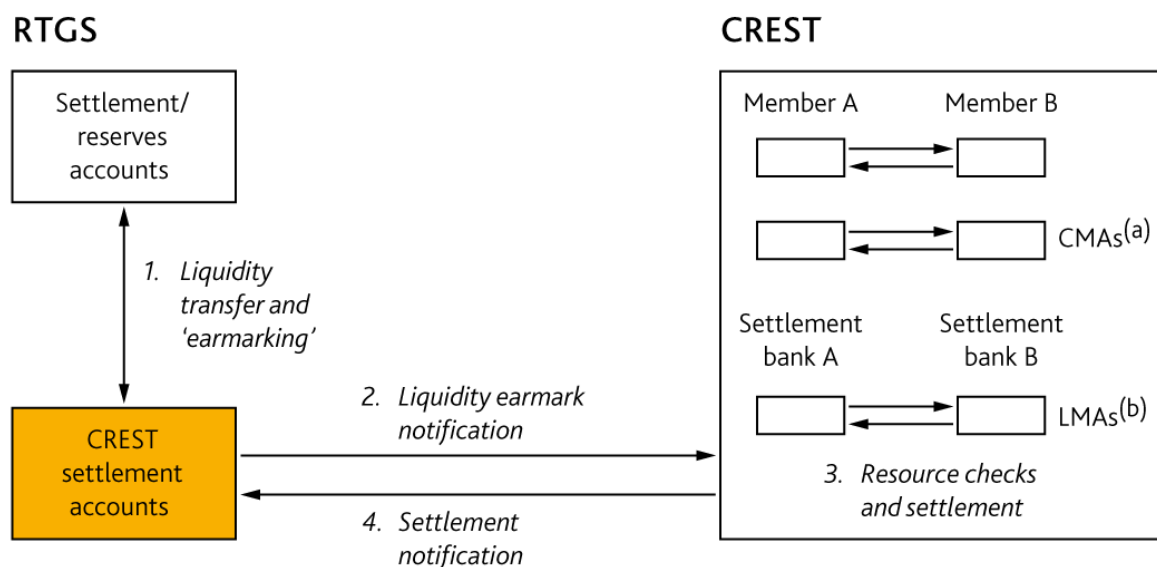

(a) Cash Memorandum Accounts.

(b) Liquidity Memorandum Accounts.

IV.90 As with CHAPS transfers, the Bank supports the real-time settlement process in CREST through the provision of intra-day liquidity to the CREST settlement banks; and again this is provided via an intra-day repo (under a procedure known as auto-collateralisation, which is carried out on the Bank's behalf by the CREST system).

Intra-day liquidity

IV.91 The Bank operates a collateral pooling model to support its official operations, which includes intra-day liquidity. Under this model, each SMF Participant maintains a collateral pool of securities within the Bank's collateral management system, which is used by the Bank to collateralise its current exposures.

IV.92 Intra-day liquidity is generated when there is excess eligible collateral in a member's main collateral pool. At the start of each Business Day, the Bank will credit the SMF Participant's liquidity account within the Payment Minimum Balance Group to the value of the excess eligible collateral available in the SMF Participant's main collateral pool; up to the 'intraday liquidity cap' set by each participant. At the end of each business day the Bank will debit the SMF Participant's Payment Minimum Balance Group of the intra-day liquidity amount, and the value of the excess collateral compared to exposures in the collateral pool will increase accordingly. During the operational day the value of the intra-day liquidity loan can be varied by the SMF Participant adjusting the value of excess eligible collateral in their main collateral pool.

Deferred net settlement

- IV.93 The RTGS Service provides same-day settlement on the value date for systems where multilateral net interbank obligations are settled on a deferred basis relative to the clearing of bilateral gross payments. These deferred settlements are scheduled at fixed points during the RTGS day, but may settle later than planned if there are operational delays or an account holder due to be debited lacks funds. The Bank supports multiple settlements per day per system – for example, Faster Payments currently settles three times per business day.
- IV.94 Each deferred net settlement system determines its own access criteria as well as the number and duration of settlement cycles:
- For Bacs, CHAPS, Cheque & Credit (paper and imaging), CREST and Faster Payments their Direct Participants (settlement bank in the case of CREST) must, under their respective access criteria, hold an account in RTGS which can be used for settlement.
 - For the LINK and Visa systems, a Direct Participant requires access to an account held in RTGS which can be used for settlement. Institutions ineligible for an account in RTGS may use the services of one of the other Direct Participants to settle their obligations arising from the payment system.
- IV.95 The operator of Bacs, Faster Payments and the cheque-based Image Clearing System require Direct Participants to prefund their maximum net settlement exposures. This involves a separate prefunding account²⁷ in RTGS for each directly-settling participant in Bacs, Faster Payments and the cheque-based Image Clearing System. Each prefunding account is linked to the relevant account holders' primary settlement account. Account balances in the prefunding account must always be greater than, or equal to, the size of a participant's 'cap' value (the maximum net debit position they are allowed to incur) in the relevant payment system.
- IV.96 Balances held in prefunding accounts that are in excess of the minima required to prefund deferred net settlement payment systems are withdrawable at times of stress. The 'minima required' refers to payments that are irrevocable but not yet settled. The caps set in Bacs, FPS, and the cheque-based Image Clearing System can be lowered to the 'minima required' at the request of the firm (and therefore the associated minimum balances set on the relevant prefunding account(s)).

²⁷ Prefunding accounts may be Reserves Collateralisation Accounts (for SMF participants), Settlement Collateralisation Accounts (typically for PRA-authorized institutions who do not hold a reserves account) or Completion Funds Accounts (for non-bank payment service providers).

Table 5: Summary of RTGS daily timetable

RTGS, CHAPS and Net Settlement Events	Time	CREST Event	Time
Transfers between own accounts and Enquiry Link access enabled; and Notes Circulation Scheme settlement	05:15		
Start of CHAPS settlement	06:00	Start of Delivery vs. Payment (DvP)/Free of Payment (FOP) ²⁸ settlement	06:00
Hourly CLS pay-in and/or pay-out deadlines	07:00 to 11:00		
Faster Payments settlement	07:05		
Bacs settlement	09:30		
Cheque & Credit settlements (up to six settlements between 10:40 and 11:10)	10:40		
LINK settlement	11:00		
CHAPS 50% Throughput Target	12:00		
Faster Payments settlement	13:05		
Visa settlement	14:00		
		End of equity and gilt DvP settlement	14:55
CHAPS 75% Throughput Target	15:00	Start of Delivery By Value (DBV) settlement ²⁹	15:00
Image Clearing System settlement	16:30		
Faster Payments settlement	17:05		
CHAPS 90% Throughput Target	90%		
		End of DBV settlement	17:30
End of CHAPS settlement for customer payments (MT103)	17:40		
End of CHAPS settlement for interbank payments (MT202)	18:00	End of FOP settlement	18:00
Notes Circulation Scheme settlement	18:30		
Latest end of contingency extension	20:00	Latest end of contingency extension	19:30

²⁸ FOP refers to free of payment, a delivery of securities which is not linked to a corresponding transfer of funds.

²⁹ DBV refers to Delivery-by-Value, whereby a member may borrow or lend cash against collateral in CREST for an agreed term. The system selects and delivers an agreed value of collateral securities meeting pre-determined criteria against cash from the account of the cash borrower to the account of the cash lender and reverses the transaction at the end of the agreed term.

RTGS Renewal Programme

IV.97 On 9 May 2017, the Bank published a Blueprint for RTGS renewal.³⁰ The Bank is designing the renewed RTGS to deliver a resilient, flexible and innovative sterling payment system for the United Kingdom to meet the challenges posed by a rapidly changing landscape. This followed a significant phase of stakeholder engagement and consultation. The renewed RTGS service is being delivered through a multi-year programme of work, and has designed the programme to be an open and collaborative effort with extensive stakeholder engagement at all stages.

IV.98 The renewed RTGS will deliver a range of new features and capabilities. This is necessary because the way payments are made has changed dramatically in recent years, reflecting changes in the needs of households and companies, changes in technology, and an evolving regulatory landscape.

IV.99 The Bank's vision for the renewed RTGS is organised around five key features:

- Higher resilience: The Bank will further strengthen the resilience of RTGS and flexibility to respond to emerging threats, including through enhanced contingency messaging channels.
- Broader access: The Bank will facilitate greater access to central bank money settlement for institutions and infrastructures. The Bank has already announced extended access for non-bank payment service providers. Further changes will target streamlining testing, connectivity and on-boarding as well as reducing the cost of access. In the medium term, the Bank will also require institutions above a certain value threshold to access CHAPS directly.
- Wider interoperability: The Bank will promote harmonisation and convergence with critical domestic and international payment systems. The Bank will adopt ISO 20022 messaging, facilitate synchronisation with other infrastructures, and promote alternative processing arrangements for time-critical retail payments.
- Improved user functionality: The Bank will support emerging user needs in a changing payment environment. Enhancements include near 24x7 technological capability, use of Application Programme Interface (API), and other tools to track and manage payments.
- End-to-end risk management: Responsibility for the management and operation of the CHAPS system transferred to the Bank in November 2017. The Bank continues to enhance its approach to management risks in CHAPS. As the systemic risk manager for CHAPS, the Bank seeks to manage risks to the end-to-end flow of payments.

³⁰ <https://www.bankofengland.co.uk/paper/2017/a-blueprint-for-a-new-rtgs-service-for-the-uk>

Annex 1 – Key documents relating to the RTGS and CHAPS services

Legal documentation

Published documents:

- RTGS/CHAPS fees: <https://www.bankofengland.co.uk/-/media/boe/files/payments/rtgstariffs.pdf>
- RTGS Settlement Account Policy: <https://www.bankofengland.co.uk/-/media/boe/files/payments/boesettlementaccounts.pdf>
- RTGS Terms & Conditions, including annexes: <https://www.bankofengland.co.uk/-/media/boe/files/payments/rtgs-mandate-and-annexes.zip>
- CHAPS Reference Manual: <https://www.bankofengland.co.uk/-/media/boe/files/payments/chaps/chaps-reference-manual.pdf>
- CHAPS Technical requirements: <https://www.bankofengland.co.uk/-/media/boe/files/payments/chaps/chaps-technical-requirements.pdf>

Documents shared with current and prospective account holders and payment system operators:

- Bespoke agreements with payment system operators
- Additional documentation for CREST settlement banks
- RTGS Reference Manual

Annex 2 – Useful links

General information relating to RTGS and CHAPS

- Background on RTGS/CHAPS including governance, risk management, and services provided: <https://www.bankofengland.co.uk/payment-and-settlement>
- Dedicated page for the CHAPS service: <https://www.bankofengland.co.uk/payment-and-settlement/chaps>
- Volume, value, and availability statistics for RTGS/CHAPS: <https://www.bankofengland.co.uk/payment-and-settlement/payment-and-settlement-statistics>

Quarterly Bulletin articles

- [Enhancing the resilience of the Bank of England's Real-Time Gross Settlement infrastructure](#)
- [The Bank of England's Real-Time Gross Settlement Infrastructure](#)
- [How has the Liquidity Saving Mechanism reduced banks' intraday liquidity costs in CHAPS?](#)

General information relating to the Sterling Monetary Framework

- [Sterling Monetary Framework](#)
- [Sterling Monetary Framework – The Red Book](#)
- [Reserves Accounts in RTGS – Quick reference guide](#)

General information relating to the Bank and related functions

- [Bank of England Annual Reports and Accounts](#)
- [Bank of England governance](#)
- [Bank's application of the Senior Managers Regime](#)
- [FMI Supervision Annual Report 2018](#)

Websites of the payment system operators

- [Pay.UK](#) – operator of Bacs, Cheque & Credit (imaging and paper), and Faster Payments
 - o [Bacs](#)
 - o [Cheque & Credit](#)
 - o [Faster Payments](#)
- [CLS](#)
- [Euroclear UK & Ireland](#)
- [LINK](#)

- [Visa Europe](#)

Principles for financial market infrastructures publications

- [Principles for financial market infrastructures](#)
- [Principles for FMIs: Disclosure framework and assessment methodology](#)
- [Application of the Principles for financial market infrastructures to central bank FMIs](#)

RTGS Renewal Programme

- RTGS Renewal Programme, including the Blueprint:
<https://www.bankofengland.co.uk/payment-and-settlement/rtgs-renewal-programme>
- RTGS Renewal Programme News: <https://www.bankofengland.co.uk/payment-and-settlement/rtgs-renewal-programme/rtgs-renewal-programme-news-events-and-milestones>
- ISO 20022, a new messaging standard for UK payments:
<https://www.bankofengland.co.uk/payment-and-settlement/rtgs-renewal-programme/consultation-on-a-new-messaging-standard-for-uk-payments-iso20022>

Annex 3 – Glossary

Auto-Collateralising Repo (ACR) – For the purpose of transactions settling in CREST, the repurchase agreement (repo) automatically generated by the CREST system between a CREST Settlement Bank's repo member account and/or its linked member account and the Bank. It delivers collateral to the Bank against which liquidity is provided by the Bank in the event of that CREST Settlement Bank would otherwise have insufficient liquidity available in CREST to settle a transaction. The Bank's agreements with each CREST Settlement Bank cover the generation and use of ACRs.

Automated Liquidity Transfer (ALT) – An automated movement of liquidity between different accounts, in RTGS. Certain ALTs are executed at the start of day as a means of putting liquidity into a CHAPS Settlement account. Enquiry Link also offers a facility, which transfers liquidity between a settlement bank's CHAPS and CREST accounts intra-day, when balances reach certain pre-specified parameters.

Bank or Bank of England – The Governor and Company of the Bank of England.

Bacs - The Direct Debit and Bacs Direct Credit payment schemes, generally used to pay salaries, settle invoices from suppliers and for direct debits. Bacs Payment Schemes Limited became a wholly owned subsidiary of Pay.UK in 2018.

Central Bank Money – The liabilities of the central bank, either in the form of banknotes, or reserves that are held by financial institutions at the Bank. Central bank money is close to risk-free: the risk of the Bank defaulting is the lowest of any agent in the economy.

Central Counterparty (CCP) – A financial market infrastructure (FMI) set up to act as an intermediary between trading counterparties to clear and settle trades. Importantly, a CCP becomes the buyer to every seller and the seller to every buyer. A CCP effectively guarantee the obligations to transfer cash or assets under a contract agreed between two counterparties. If one party fails, the other is protected as the CCP assumes the position of the defaulting party. Ultimately, resulting exposures to CCPs are protected by the default management procedures and resources of the CCP.

Central Scheduler - A logical process within the RTGS processor which allows CHAPS Direct Participants to manage their liquidity and control when CHAPS settlement requests are submitted for settlement. Once in the Central Scheduler, payments can be 'matched' via LSM, or cancelled by the sending CHAPS Direct Participant.

Central Securities Depository (CSD) - An FMI that holds records of individual securities and operates a Securities Settlement System, allowing transfer of ownership between parties through a book entry, rather than the transfer of physical certificates.

CHAPS - CHAPS is the sterling same-day payment system operated by the Bank, used to settle high-value wholesale payments, as well as time-critical, lower-value payments.

CHAPS Strategic Advisory Forum – The Strategic Advisory Forum is an advisory body which aims to support an ongoing and effective two-way dialogue between the RTGS/CHAPS Board, the executive responsible for CHAPS, and a representative set of senior and experienced users of the CHAPS service.

Cheque & Credit Clearing (C&CC) - A retail payment scheme for the clearing of cheques through the physical transfer of the paper instrument. The scheme settles on a DNS basis in RTGS, with completion of settlement supported by a liquidity funding and collateralisation agreement in the event that a participant defaults. It is currently being replaced by the Image Clearing System. The scheme is operated by the Cheque & Credit Clearing Company Limited, which became a subsidiary of Pay.UK in 2018.

CPMI-IOSCO - Committee on Payments and Market Infrastructures (CPMI) and the International Organisation of Securities Commissions (IOSCO). Both institutions are recognised by the Financial Stability Board (FSB) as standards-setting bodies, and work in collaboration to agree and publish the PFMI.

CRD (Cash Ratio Deposit) - Non-interest bearing deposits that both banks and building societies (known in this context as 'eligible institutions') are required to place with the Bank of England in accordance with the Bank of England Act 1998.

Continuous Linked Settlement (CLS) - A settlement service based in New York that provides global FX settlement in major currencies, including sterling. For sterling operations, CLS is a CHAPS settlement bank, enabling CLS participants to use CHAPS to fund net sterling requirements arising in CLS. Settlement takes place during the defined window when all real time gross settlement systems in the CLS settlement currency jurisdictions are open and able to make and receive payments.

CREST – The securities settlement system operated by Euroclear UK & Ireland Limited to facilitate the transfer of gilts, eligible debt, equity securities and other uncertified securities.

Custodian bank - A custodian bank is responsible for the safeguarding and upkeep of their customer's securities. The Bank uses custodian banks abroad as sub-custodians in order to facilitate collateral links.

Direct Participants (DP) - Direct participants are those banks, building societies and other PSPs that access one of the UK payment systems (such as CHAPS, Faster Payment or Bacs) directly.

Deferred Net Settlement (DNS) Payment System – A payment system where the obligations between participants are settled by calculating the sum of the payments made, minus the sum of the payments received, by each participant, over a defined period. This is opposed to settling each payment individually, and on a gross basis, like CHAPS. Settlement in RTGS takes place after the individual customer payments are cleared and exchanged.

Delivery versus Payment (DvP) – A mechanism to ensure that an asset is transferred if and only if the payment for the transfer of the asset is made at the same time.

End-to-End Systemic Risk Manager – The Bank is the systemic risk manager for the CHAPS system. At a high level, a systemic risk manager identifies, assesses, manages and responds to the full range of risks arising at all points in the system, looking at the system as a single entity.

Enquiry Link – The system that allows RTGS account holders and certain other organisations to interrogate balance and other information and to perform certain other functions.

Euroclear UK and Ireland Ltd (EUI) – The organisation that owns and operates the CREST system; part of the Euroclear group.

Faster Payments (FPS) – The UK retail scheme used for sending payments in near real-time. FPS is generally used for mobile or internet payments and for standing orders payments. Faster Payments Scheme Limited became a wholly owned subsidiary of Pay.UK in 2018.

Financial Conduct Authority (FCA) – The FCA is responsible for the conduct regulation of a wide range of financial institutions. Banks are dual regulated by the PRA and the FCA for prudential and conduct purposes respectively. For certain firms, such as non-bank payment service providers, the firm is solo-regulated by the FCA for prudential and conduct regulation.

Financial Markets and Insolvency (Settlement Finality) Regulations 1999 –The Regulations provide designated payment and settlement systems with certain protections against the normal operation of insolvency law, in order to reduce the likelihood of disruption to financial stability.

Image Clearing System (ICS) – A retail payment scheme for the processing and clearing of cheque images. It is operated by the Cheque & Credit Clearing Company Limited, which became a subsidiary of Pay.UK in 2018. Unlike the paper system, ICS is a prefunded DNS system. ICS will ultimately replace the existing paper system (Cheque & Credit Clearing)

Indirect Participant – A bank, building society or other PSP that accesses a payment system through another institution. Typically this institution is one of the Direct Participants of the relevant system.

Intra-day liquidity – Liquidity provided to certain CHAPS Direct Participants and CREST Settlement Banks to help ensure that they are able to make sterling payments, in addition to drawing on their reserves balances. The liquidity must be repaid before the end of the day.

ISAE 3402 – The International Standard on Assurance Engagements (ISAE) 3402 replaces SAS 70 (the Statement on Auditing Standards No. 70), which defined the standards an auditor must employ in order to assess the contracted internal controls of a service organisation.

ISO 20022 messaging standard – ISO20022 is a globally-agreed and managed method for creating financial messaging standards. It will enrich the data carried in payments messages, improve compatibility across technology platforms and create opportunities for collaboration and innovation.

Level A collateral – Level A collateral is a subset of the highest rated sovereign debt, with low credit, liquidity and market risk. A fuller definition is published in the Bank's Red Book, and a list of eligible collateral is provided on the Bank's website.

LINK - LINK is the retail payment system that supports the UK's cash machine network. It settles on a DNS basis in RTGS.

Liquidity Saving Mechanism (LSM) – Functionality within the RTGS Processor which matches pairs or groups of CHAPS Payments, settling them in batches simultaneously to

offset their liquidity needs against one another. CHAPS Direct Participants use the Central Scheduler to manage their payment flows within the RTGS Processor and the Matching Process employs algorithms to attempt to offset the queued payments.

Market Infrastructure Resiliency Service (MIRS) – A contingency payment settlement service provided by SWIFT that offers a market infrastructure operational resilience in the event of unavailability of its RTGS system. Once activated, MIRS calculates accurate balances for all RTGS accounts and provides final settlement in central bank money.

Matching Cycle - A single running of the LSM Matching Process.

MT103 – SWIFT message type for single customer credit transfers.

MT202 – SWIFT message type for general financial institution transfers.

Market Services Division (MSD) – The division within the Bank of England which supports the operation of the CHAPS and RTGS services.

Non-Bank Payment Service Provider (NBPSP or Non-Bank PSP). The term used to describe two categories of regulated institutions that are not banks but specialise in providing payment services: E-Money Institutions and Payment Institutions.

New Payments Architecture (NPA) - The New Payments Architecture, under the governance of Pay.UK, will renew the technical infrastructure support the processing of Bacs and FPS retail payments and associated payment services

Non-CHAPS transfers – Non-CHAPS transfers as real-time gross transfers of funds within RTGS but outside the scope of the CHAPS scheme. These are largely to support the functioning and administration of the RTGS system itself, and include the transfers account holders may make between their own accounts within RTGS, and interest credited to reserves accounts. A full list is set out in the RTGS Reference Manual.

Note Circulation Scheme (NCS) – The scheme operated by the Bank which governs the distribution, processing and storage of banknotes issued by the Bank. Payments associated the Bank's [Note Circulation Scheme](#) (NCS), such as purchases of banknotes by participants from the Bank are settled via RTGS.

Operational Error Lending Scheme (OELS) – Part of the error handling procedures for DvP transactions in CREST. OELS governing how the Bank and EUI may request CREST settlement banks, that are prematurely enriched due to an operational error, to temporarily lend an equivalent amount of liquidity back to the 'overdrawn' bank, on an unsecured intra-day basis.

Pay.UK - The consolidated entity responsible for the operation of four of the UK's retail payment systems via its operating subsidiaries– Bacs, Faster Payments, Cheque & Credit and the Image Clearing System. Pay.UK was previously known as the New Payment System Operator (NPSO).

Payment Minimum Balance Group – A group of accounts in RTGS all held by the same account holder. The prime account within the group is the Payment Settlement Account (which may be the Reserves Account) across which all CHAPS payments are settled. Other accounts within the group are liquidity accounts. The prime account within the group may go

overdrawn intra-day providing it is supported by funds on the Liquidity Accounts, i.e. the Minimum Balance Group as a whole may not go overdrawn.

Payment Service Provider (PSP) - Any institution that provides payment services by way of business, such as banks, building societies, E-Money Institutions, and Payment Institutions.

Payment Systems Regulator (PSR) – The independent economic regulator of payment systems in the UK. The PSR has objectives to ensure payment systems develop and are operated in the interests of consumers, whilst promoting competition and innovation.

Point of Irrevocability – The stage of a payment transaction specified in the payment system's rulebook at which the payment has passed the point where it can be revoked by the payment initiator. It is defined separately for each payment system and is linked but not always equivalent to the point of finality.

Prefunding Account – A segregated account held at the Bank of England used for prefunding. There are three types of Collateralisation Account:

- Reserves Collateralisation Accounts (RCAs) for members of the SMF already holding a reserves account;
- Settlement Collateralisation Accounts (SCAs) for institutions ineligible for SMF membership settling using their own funds; and
- Completion Funds Account (CFAs) for institutions ineligible for SMF membership settling using their clients' funds.

Each settlement participant of a prefunded system has a separate prefunding account for each payment system. The Minimum Balance on each prefunding account is maintained by the operator of the relevant payment system to correspond to the net debit cap in the payment system, and a balance equal to or in excess of the net debit cap must remain in place at all times. The balance on an RCA forms part of an institution's total reserves account balance. All prefunding accounts (RCAs, SCAs and CFAs) are remunerated at the same rate as reserves accounts (i.e. Bank Rate).

Prefunding – A model for collateralising Deferred Net Settlement Payment Systems that uses cash balances to eliminate settlement risk between direct settling members. Each settlement participant always has the necessary resources set aside in an RCA, SCA or CFA to meet their maximum possible settlement obligation. Prefunding is currently used within Bacs, Faster Payments and the Image Clearing System.

Principles of Financial Market Infrastructure (PFMIs) - The PFMIs are internationally agreed standards published by the Committee on Payments and Market Infrastructures (CPMI) and the International Organisation of Securities Commissions (IOSCO). They are part of a set of standards that the international community considers essential to strengthening and preserving financial stability.

Risk Management Framework - The Risk Management framework outlines the system of risk management for the Bank's delivery of RTGS and CHAPS. The framework is intended to ensure that risks are identified, assessed, monitored, reported and controlled appropriately when the Bank deliver the RTGS and CHAPS systems in line with the agreed business aims.

Real-Time Gross Settlement (RTGS) – The accounting arrangements established for the settlement in real-time of sterling payments across settlement accounts maintained in the RTGS System.

Red Book – The document which explains the framework for the Bank's operations in the sterling money markets – the Sterling Monetary Framework. The Red Book is periodically updated to reflect changes to the Bank's operations.

Reserves Account – An account held at the Bank of England for the purpose of the Bank's reserves account facility under the Sterling Monetary Framework, as described in the Red Book.

RTGS/CHAPS Board – The RTGS/CHAPS Board (the Board) provides strategic leadership for the RTGS infrastructure and CHAPS payment system. The Board operates within the Bank's wider governance structure, reporting to the Governor and Court.

RTGS/CHAPS Board Risk Committee – The RTGS/CHAPS Board Risk Committee has delegated responsibility (from the Board) for monitoring of the CHAPS and RTGS risk management framework risk tolerances and risk profiles.

RTGS Reference Manual – A manual describing the RTGS facility provided by the Bank for account holders in accordance with and subject to any limitations contained in their mandate agreement. It also contains the operating procedures describing intra-day liquidity advances between the Bank and relevant account holders.

RTGS Renewal Programme- In 2017, the Bank published a Blueprint for renewing the UK's RTGS infrastructure. The multi-year Programme will deliver a resilient, flexible and innovative sterling payment infrastructure for the United Kingdom to meet the challenges posed by a rapidly changing landscape.

RTGS Terms & Conditions – A document that all RTGS account holders are required to sign up to, detailing the legal basis for the Bank's operation of RTGS, and the rights and obligations of the Bank and account holders in the provision and use of this service.

Settlement Service Provider Agreement – The Settlement Service Provider Agreement is an agreement between the Bank of England and each Deferred Net Settlement Payment System operator that governs the relationship between the Bank, as settlement service provider, and each operator.

Settlement Account – Term used for a reserves account used to settle obligations in a payment system which settles across RTGS. Or where the institution is ineligible for a reserves account, an account held in RTGS for the purpose of settling obligations in a payment system which settles across RTGS.

Sterling Monetary Framework (SMF) – The framework for the Bank's operations in sterling money markets. The operations are designed to implement the Monetary Policy Committee's decisions in order to meet the inflation target and reduce the cost of disruption to the critical financial services, including liquidity and payment services, supplied by SMF participants to the UK economy. The framework is explained in the Red Book (see above)

SWIFT (Society for Worldwide Interbank Financial Telecommunication) - SWIFT is a global member-owned cooperative that provides secure financial messaging services.

Throughput – Throughput refers to the proportion of a day's payments that has been made by a particular time.

Tiering - Where indirect participants access a payment system through another institution.

Vocalink – Vocalink is an infrastructure provider that currently provides the clearing infrastructure for the Bacs, FPS, ICS and LINK payment systems.

Visa - A retail payment scheme settled on a deferred net basis in RTGS. Visa facilitates electronic fund transfers via cards.

Principle 1-Legal Basis

An FMI should have a well-founded, clear, transparent, and enforceable legal basis for each material aspect of its activities in all relevant jurisdictions.

Scope and applicability: This principle refers to rules, procedures and contracts. The provision of RTGS and CHAPS services remain governed by separate legal documentation reflecting the different nature of the services and different participants. It also reflects the historically separate governance arrangements by the Bank for the RTGS infrastructure and CHAPS Co for the CHAPS payment system, prior to the responsibilities for CHAPS transferring to the Bank in November 2017.

Rating: Observed

Summary of compliance: The Bank has implemented appropriate and robust legal coverage for the RTGS and CHAPS services. The Bank draws on in-house legal experts and external legal services to produce legal documentation and to review any legal agreement that the Bank enters into as operator of the RTGS and CHAPS services. Where there exists a risk for legal uncertainty, the Bank commissions legal opinions to help it assess the potential legal risk and to consider any appropriate mitigants.

Key consideration 1.1: Legal basis should provide a high degree of certainty for each material aspect of an FMI's activities in all relevant jurisdictions.

Provision of accounts in RTGS

Eligibility criteria and policies for admitting account holders into RTGS are specified in the Bank's published Settlement Account Policy. This was updated in July 2017 to permit non-bank payment service provider access to RTGS settlement accounts (see *Principle 18 - Access and participation requirements*).

The Bank has robust legal documentation which governs the provision of accounts in RTGS, primarily the RTGS Terms & Conditions. These set out the legal framework for how accounts are operated. Account holders in RTGS sign a mandate letter, agreeing to be legally bound by the RTGS Terms & Conditions and by the relevant annexes. The annexes set out additional terms and conditions depending on the services provided, and whether the

institution will be a directly-settling participant in a particular payment system,³¹ or wishes to open a reserves or settlement account.

The intraday liquidity loans annex sets out the terms and conditions pursuant to which the Bank provides intraday liquidity to certain CHAPS Direct Participants. Additional documents are required for CREST settlement banks setting out the terms and conditions pursuant to which we provide the DvP settlement arrangements for CREST.

Where an institution wishes to participate in the Bank's Sterling Monetary Framework (which has its own eligibility criteria) and hold a reserves account, the institutions will need to sign up to the RTGS Terms & Conditions and the Reserves Accounts Annex. The institution will also need to sign up to the SMF Terms & Conditions which govern, amongst other things, the provision of collateral to cover any RTGS exposures using collateral held by account holders in the single collateral pool.

The documents referred to above are amended periodically and published on the Bank's website (except the additional CREST documentation).

CHAPS-specific documentation

CHAPS Direct Participants (DPs) enter into a Participation Agreement with the Bank with respect to the CHAPS system. CHAPS DPs are required to comply with obligations set out in the CHAPS Reference Manual. CHAPS DPs are also required to sign the CHAPS Sterling Payments Annex to the RTGS Terms & Conditions.

The CHAPS payment system is designated under the Financial Services (Banking Reform) Act 2013 for regulation by the Payment Systems Regulator (PSR). This gives the PSR certain powers over Payment Service Providers (PSPs) who participate in the CHAPS system. For example, the PSR may require a CHAPS DP to grant indirect access to CHAPS to another PSP under section 56(3). Ordinarily, the PSR would have regulatory powers over the payment system operator and infrastructure provider(s) for designated systems. However, the Bank is exempt from the application of these regulatory powers.

Relationship with EUI

The CREST system is operated by Euroclear UK & Ireland (EUI). CREST operates on a 'Delivery versus Payment' (DvP) basis, meaning that the legal transfer of a security occurs if,

³¹ For the avoidance of doubt, payment system and payment system operator include CREST and EUI respectively through this self-assessment unless noted otherwise, reflecting the embedded payment arrangements within the CREST securities settlement system. There is additional contractual documentation for CREST.

and only if, the payment for the security is settled over RTGS. The Bank and EUI have put in place arrangements to enable sterling payments for securities settlement to be made on a real-time basis through the CREST system. The rights and obligations of the Bank, as operator of the RTGS Service, and EUI are set out in a bilateral contract.

Separately, the contractual framework governing the service between the Bank, EUI and each of the CREST settlement banks is set out in a framework agreement. A new CREST settlement bank is required to enter into the RTGS CREST mandate agreement with the Bank governing the operation of the sterling CREST accounts. The Bank also has a contractual framework in place to govern the operation of the auto-collateralising repurchase transactions which the Bank enters into with the CREST settlement banks.

Relationship with retail payment system operators

The Bank, acting as settlement service provider, provides settlement services, pursuant to Settlement Service Provider Agreements, to a number of payment system operators of deferred net settlement systems (the Bacs, Faster Payments and paper cheque and image clearing schemes operated by Pay.UK, as well as the LINK and Visa schemes). These enable directly-settling participants to settle multilateral net obligations arising in the relevant payment systems across their RTGS accounts.

Directly-settling participants in the Bacs, Faster Payments and Image Clearing schemes hold cash in special accounts to cover the maximum possible net debit positions they could reach in those systems. For institutions with a reserves account, the balance on each account forms part of their overall reserves balance and is remunerated at the same rate (i.e. Bank Rate). If one of the participants defaults, the cash set aside can be used to fulfil its obligation enabling the multilateral settlement to complete. This eliminates credit risk between Direct Participants in Bacs, Faster Payments and the Image Clearing schemes and removes the mutualised risk that was inherent in the previous arrangements. This is underpinned by a set of contractual agreements.

Jurisdictions

The Bank only provides sterling settlement within the United Kingdom. All contractual relationships with RTGS account holders, payment system operators and CHAPS Direct Participants are governed by English law and subject to the Courts of England and Wales.

Some institutions participate in RTGS and/or CHAPS that are incorporated in a jurisdiction other than England and Wales. In these cases, the Bank may ask for legal opinions. In such an instance, the Bank may require that the legal opinion (a) confirms the institution's power

and authority to enter into and to execute the documentation and (b) opines on the enforceability of the RTGS and/or CHAPS documentation as applicable (and the rights and obligations thereunder).

The Bank also allows RTGS account holders to generate sterling liquidity by posting euro-denominated central bank money held outside RTGS as collateral. When euro cash is used for liquidity generation, the cash is held by the Bank in a named account with a Eurozone central bank. The agreements between the Bank and the Eurozone central bank underlying this arrangement are subject to the relevant local law.

Key consideration 1.2: An FMI should have rules, procedures, and contracts that are clear, understandable, and consistent with relevant laws and regulations.

The Bank's legal documentation for the RTGS and CHAPS services is clear, understandable and consistent with English law. It is comprised of standardised agreements which have been drafted in a clear and considered manner. Documents are drafted, regularly reviewed, and if necessary updated by the Bank's internal legal team (together with external legal advisors), in consultation with business area experts. Reviews also take place at certain trigger points. For example, documentation is reviewed and revised in anticipation of changes to legislation (for example, the introduction of GDPR). The CHAPS documentation was also reviewed and updated at the point the Bank took responsibility for the CHAPS service.

The Bank seeks external legal advice on any substantial changes it makes to RTGS and/or CHAPS documentation. The Bank provides a RTGS Reference Manual and a number of user guides to supplement the RTGS legal documentation, and a CHAPS Operational Reference Manual, CHAPS Technical Reference Manual and other documents to supplement the CHAPS legal documentation. These documents are made available both to existing and potential account holders, payment system operators and CHAPS Direct Participants, as relevant. These provide clear and understandable descriptions of the RTGS and CHAPS services consistent with their respective legal frameworks.

The Bank works with prospective RTGS account holders and CHAPS Direct Participants to ensure they have a sufficient understanding of the RTGS and/or CHAPS requirements and procedures. As part of the signing of the legal documentation, applicants for an RTGS account confirm to the Bank that they understand the legal and operational requirements of holding and operating an RTGS account. Similarly, CHAPS DPs confirm to the Bank that they understand and will adhere to the obligations contained in the CHAPS Reference Manual.

Material changes to the CHAPS rules, procedures and contracts require a non-objection from the Bank's FMI Directorate, which supervises the Bank's operation of the CHAPS system on a non-statutory basis. The FMI Directorate also review changes that might impact the adequacy of CHAPS default arrangements, as the designating authority under the Financial Markets and Insolvency (Settlement Finality) Regulations 1999 (SFR).

Key consideration 1.3: An FMI should be able to articulate the legal basis for its activities to relevant authorities, participants, and, where relevant, participants' customers, in a clear and understandable way.

The Bank articulates the legal basis for its activities in the RTGS Terms & Conditions and CHAPS service documentation, as well as its contracts with the payment system operators and the documents governing the Bank's provision of settlement arrangements for CREST. All documents are governed by, and enforceable under, English law. This documentation is clearly set out and made available to relevant stakeholders, with most documents available on the Bank's website.

Key consideration 1.4: An FMI should have rules, procedures, and contracts that are enforceable in all relevant jurisdictions. There should be a high degree of certainty that actions taken by the FMI under such rules and procedures will not be voided, reversed, or subject to stays.

The Bank's contracts with account holders, including CHAPS Direct Participants, and payment system operators are governed by, and enforceable under, English law. Where an institution is incorporated in a jurisdiction other than England and Wales, the Bank asks, where required, for a legal opinion covering, amongst other things, the enforceability of the agreements (and the rights and obligations contained therein). As such, the Bank has a high degree of confidence that the relevant rules, procedures and contracts are enforceable in all relevant jurisdictions.

The documentation is reviewed regularly and in advance of any changes to RTGS and CHAPS to ensure they remain enforceable and provide robust legal protection.

Collateral

The Bank, as operator of the RTGS service, takes collateral to secure intraday exposures to RTGS account holders in its liquidity provision operations. All relevant collateral is transferred by way of full title transfer to the Bank, which ensures that the Bank can enforce on the collateral immediately if required.

The Financial Markets and Insolvency (Settlement Finality) Regulations 1999 modifies the law of insolvency in so far as it applies to collateral security provided to the Bank in connection with its functions as a central bank.

CHAPS – transfer orders

The CHAPS payment system is designated under the Financial Markets and Insolvency (Settlement Finality) Regulations 1999 (as amended). As a designated system, payments within CHAPS have certain protections against normal insolvency law. This guarantees that payments which enter into the CHAPS payment system are finally settled, even if the sender has become insolvent or transfer orders have been revoked i.e. CHAPS payments cannot be voided or reversed at the request of an insolvency practitioner. The CHAPS Reference Manual defines the point at payments are deemed as finally settled and therefore transparently marks the point at which settlement finality occurs within the CHAPS payment system.

The Bank has a very low risk tolerance to uncertainties surrounding or a lack of settlement finality protection for CHAPS.

Non-CHAPS payment systems that settle across RTGS

CREST, Bacs, Faster Payments and Cheques (both the paper and Image Clearing schemes), are all designated under the Financial Markets and Insolvency (Settlement Finality) Regulations 1999 and payments in those systems receive similar protections against insolvency law to ensure that, amongst other things, notwithstanding a directly-settling participant's insolvency, any transfers within these systems that have been submitted into the relevant system are irrevocable (beyond a defined processing point) and that collateral security is enforceable.

Further reference is made to settlement finality in the self-assessment against *Principle 8 – Settlement Finality*.

Key consideration 1.5: An FMI conducting business in multiple jurisdictions should identify and mitigate the risks arising from any potential conflict of laws across jurisdictions.

While RTGS and CHAPS are operating solely within the UK in sterling, and all RTGS and CHAPS documentation is governed by English law, some account holders, including some CHAPS DPs, operate outside the UK. Where required, the Bank may ask for legal opinions opining on (amongst other things) the enforceability of the documentation, including an

opinion of whether (a) the choice of English law to govern the documents will be recognised and upheld as a valid and effective choice of law by a court of the relevant home country; and (b) the judgment of an English court would be recognised and given effect in the relevant home country without a re-examination or re-litigation.

Principle 2-Governance

An FMI should have governance arrangements that are clear and transparent, promote the safety and efficiency of the FMI, and support the stability of the broader financial system, other relevant public interest considerations, and the objectives of relevant stakeholders.

Scope and applicability: Applicable to the combined governance arrangements for the RTGS and CHAPS services. Under the CPMI-IOSCO guidance note on application of the PFMI to central bank FMIs, where an FMI is operated as an internal function of the central bank, the PFMI are not intended to constrain the composition of the central bank's governing body or that body's roles and responsibilities.

Rating: Broadly observed

Summary of compliance: The Bank has defined governance arrangements for the RTGS and CHAPS services, with a strong focus on the Bank's mission to maintain monetary and financial stability. These are defined through: codified roles, compositions and reporting lines; business area objectives; and individual job descriptions.

Responsibility for the CHAPS system transferred to the Bank in November 2017. A new, combined set of governance arrangements for RTGS and CHAPS was introduced at the same time, replacing the previously separate governance arrangements at the Bank for the RTGS service, and at CHAPS Co for CHAPS.

The revised governance arrangements had only been in place for around seven months as at the point of assessment (end-June 2018). The arrangements have been designed to meet best practice, where appropriate. The arrangements increase the degree of internal and external independent challenge that the Bank's operation of RTGS and CHAPS is subject to.

The experience of these early months is that the structure in place is appropriate and working effectively. However, it is also too early to demonstrate that the governance arrangements have a track record of consistently functioning as fully effective over an extended period of time. Rating the principle as 'broadly observed' at this stage indicates that, whilst we believe that the arrangements have been operating effectively over the first few months, it is too soon to reach a mature self-assessment of the governance outcomes produced by the new governance arrangements.

Key consideration 2.1: An FMI should have objectives that place a high priority on the safety and efficiency of the FMI and explicitly support financial stability and other relevant public interest considerations.

The Bank's mission is to promote the good of the people of the UK by maintaining monetary and financial stability, as detailed in the Bank's Annual Report.³² This mission informs the operation of the RTGS and CHAPS services, and ensures that the Bank places a high priority on the safety and efficiency of the RTGS and CHAPS services.

RTGS was developed to enhance financial stability by removing credit and settlement risks from CHAPS and, later, CREST. The Bank also provides a net settlement service to several retail payment systems. This removes the risks associated with net obligations settled in commercial bank money for these systems. The Bank supports its financial stability objectives by providing a reliable, resilient and responsive system for high value sterling payments.

To ensure that the RTGS and CHAPS services contributes towards monetary and financial stability, and where appropriate supports other relevant public interest considerations, the Bank regularly engages with a range of users and consults on material changes to the RTGS and CHAPS services.

Key consideration 2.2: An FMI should have documented governance arrangements that provide clear and direct lines of responsibility and accountability. These arrangements should be disclosed to owners, relevant authorities, participants, and, at a more general level, the public.

Governance arrangements

The management and operation of the RTGS and CHAPS services sits within the Bank and is subject to the Bank's standard governance arrangements such as oversight by the Bank's Court of Directors and its sub-committee, the Audit and Risk Committee.

The RTGS/CHAPS Board (the Board) provides strategic leadership for the RTGS infrastructure and CHAPS payment system. The Board supports the delivery of the Bank's mission to promote the good of the people of the United Kingdom by maintaining monetary and financial stability. It also seeks to promote efficiency, innovation and competition in sterling payments, wherever that can be safely done without impairing stability.

The Board has delegated the monitoring of the CHAPS and RTGS risk management framework, risk tolerance and risk profiles to the RTGS/CHAPS Board Risk Committee, a sub-committee of RTGS/CHAPS Board chaired by an external member of the Board.

³² <https://www.bankofengland.co.uk/annual-report/2018>

As operator of a systemically important payment system, the Bank is accountable for the end-to-end risk management of the CHAPS payment system. The Board supports this through the oversight of all risks that could impact the resilience of the payment system.

There is a governance structure specific to the Bank's management and operation of the RTGS and CHAPS services. Each committee has a codified role, responsibilities, composition and reporting line. Ultimately, these committees are accountable to, and act under delegated authority from, the Bank's Governor, and through him, to the Bank's Court. Although the Bank is not legally required to adhere to the Senior Managers Regime, the Bank published how the regime would apply to the Bank. The Deputy Governor for Markets & Banking (DGM&B) has the overall responsibility for the RTGS and CHAPS services.³³

Supervision of the governance arrangements

Supervision of the Bank as the operator of the CHAPS payment system is carried out on a non-statutory basis, by the Bank's FMI Directorate, to the same standard applied to payment system operators recognised by HM Treasury for statutory supervision.³⁴

The supervisory model emphasises transparency and independence between the areas of the Bank responsible for the operation and supervision of the CHAPS system. Each area reports into a separate Deputy Governor. RTGS is not subject to supervision. These arrangements mitigate potential internal policy tensions where the Bank, as operator of the RTGS and CHAPS services, provides services to banks and FMIs.

Disclosure of governance arrangements

The Bank's enterprise-wide governance arrangements are published on its website and described in its Annual Report.³⁵

A high-level description of governance arrangements for the RTGS and CHAPS services is included on the Bank's [website](#)³⁶ and published as part of the Bank's PFMI disclosure. The new, combined governance arrangements were shared with CHAPS Direct Participants as part of the transition. Further information regarding the communication channels and the lines of accountability to stakeholders are detailed in the assessment of *Principle 23- Disclosure of rules, key procedures and market data*.

³³ <https://www.bankofengland.co.uk/-/media/boe/files/about/human-resources/smr.pdf>

³⁴ <https://www.bankofengland.co.uk/news/2018/february/supervision-of-financial-market-infrastructures-annual-report-2018> Box 2, Page 14

³⁵ <https://www.bankofengland.co.uk/annual-report/2018>

³⁶ <https://www.bankofengland.co.uk/payment-and-settlement>

Key consideration 2.3: The roles and responsibilities of an FMI's board of directors (or equivalent) should be clearly specified, and there should be documented procedures for its functioning, including procedures to identify, address, and manage member conflicts of interest. The board should review both its overall performance and the performance of its individual board members regularly.

Roles and responsibilities of the board

The collective responsibilities of the Board are set out in the Terms of Reference and broadly cover for RTGS and CHAPS: setting strategy aims and risk tolerance, reviewing the risk management framework described in *Principle 3-Framework for the comprehensive management of risks* and overseeing the risk profiles and risk mitigation, reviewing the audit programme, and reviewing business continuity and crisis management.

The Board has ten members including: DGM&B as chair; five executive members; and four external members. The external members provide additional independent and expert challenge, and broader experience and insight. One of the external members chairs the Board Risk Committee and another leads the strategic engagement with users and wider stakeholders.

Board Risk Committee

The Board has delegated the monitoring of the CHAPS and RTGS risk management framework, risk tolerance and risk profiles to the RTGS/CHAPS Board Risk Committee. The Board Risk Committee provides assurance to the Board that the Bank is discharging its risk management responsibilities as the operator of RTGS and CHAPS. It also plays a key role in reviewing and challenging on the design and implementation of the risk framework.

Board Risk Committee also forms part of the Bank's three lines of defence risk management framework.

Board Risk Committee has five members, of which two are external.

Conflicts of interest

The career experience of the external members, in particular, can raise the possibility of commercial interests that could give rise to a potential conflict. The Board has robust procedures in place to manage such conflicts to ensure the integrity and impartiality of the Board's decision making.

All Board members must declare their interests (personal, business and financial) and financial assets and liabilities. The Chairman informs the Board of any interest which may give rise to an actual or potential conflict and, the Board agrees the appropriate manner to manage that conflict.

A Board 'conflicts register' of all members' material potential conflicts and their treatment is maintained.

Review of performance

A review of the previous governance arrangements for RTGS was conducted in February 2017. As at the point of assessment, a Board Effectiveness Review has been commissioned and will complete in early 2019. The review will assess whether the Board is suitably established to discharge its responsibilities including those set out in its Terms of Reference, and to assess how effectively it has begun to discharge those responsibilities in its first year. The Board will continue to undertake regular reviews of its effectiveness in the future.

The experience of the first few months suggests to us that the Board structure in place has been operating effectively so far. However, the limited number of Board cycles to date means it is also too early to demonstrate that the Board structure has a track record of consistently functioning as fully effective over an extended period of time.

The Board, through the Chair, has committed to an annual assessment of its individual and collective skills, the first of which will be delivered in early 2019. The Board Effectiveness Review will assess the extent to which Board members, including external members, are engaged, understand the risks/issues and the reasons why key decisions have been made.

Key consideration 2.4: The board should contain suitable members with the appropriate skills and incentives to fulfil its multiple roles. This typically requires the inclusion of non-executive board member(s).

Board members as at the assessment date are: DGM&B; both the Executive Director and Head of Division responsible for the areas that operates RTGS and CHAPS; the Bank's Chief Information Officer; the Executive Director for the Bank's Markets Directorate; the Director for Supervisory Risk Specialists; and four external members, as appointed by DGM&B. This provides for a wide diversity of interests and backgrounds.

The Bank publishes the list and biographies of all ten Board members on the Bank's website, including identifying those who are external members. Some of the executive

members are also drawn from outside the RTGS and CHAPS functions, providing a degree of additional independence and challenge.

The Bank has defined a list of skills required collectively within the RTGS/CHAPS Board. The list covered three broad categories: (i) institutional and strategic skills, such as understanding the environment around CHAPS; (ii) technical knowledge and experience; and (iii) soft skills such as independence of thought and interpersonal skills. The external members were specifically recruited for their strong risk management expertise, and ability to challenge the executive. The external members all have a firm grasp of risk management, and are well-equipped to provide the challenge necessary to the executive.

The executive members were selected based on their seniority and their responsibilities for business functions and/or expertise closely connected to RTGS and CHAPS. Skills and knowledge are inherent and continually developed in relation to their specific executives roles.

Incentives for the executive members are linked to performance against their personal performance objectives that comprise an aspect of their employment with the Bank. These objectives cascade down to executive members of the RTGS/CHAPS Board from the Bank's Court and are ultimately linked to the Bank's objectives of maintaining and enhancing monetary and financial stability.

The Board and Risk Committee are able to draw on the advice of a wider range of relevant experts, who will attend meetings. They are not, however, members of the Board. For example, the Bank's Chief Information Security Officer, the Bank's Executive Director responsible for Bankwide Risk, a senior legal advisor and the Head of Audit.

Key consideration 2.5: The roles and responsibilities of management should be clearly specified. An FMI's management should have the appropriate experience, a mix of skills, and the integrity necessary to discharge their responsibilities for the operation and risk management of the FMI.

The day to day executive decision making is delegated to the head of the division that operates the RTGS and CHAPS services, supported by a local management team. They attend the RTGS/CHAPS Board and Board Risk Committee, and are advised by the RTGS/CHAPS Executive Committee and its supporting committee structure which include representation from the wider Bank including its technology and risk functions. Certain key decisions are escalated to Executive Director for Banking, Payments and Financial Resilience (ED-BPFR) or 'reserved' to the RTGS/CHAPS Board.

Roles and responsibilities are codified for the RTGS and CHAPS governance arrangements, Bankwide and local business area objectives. Performance objectives are set (and assessed) for each member of staff each year.

As of June 2018, the RTGS Renewal Programme had a parallel executive governance structure, reporting in to RTGS/CHAPS Board through an executive programme board.³⁷

Experience, skills and integrity

Local management sits at the end of the delegated chain of authority and has the appropriate integrity, skills and experience to operate the RTGS and CHAPS services. Training is provided where individual knowledge gaps are identified. Managers in the area responsible for the management and operation of the RTGS and CHAPS services are typically employees with a broad range of experience and skills, leaving them well placed to understand the relevant risks.

The Bank has a formal process for assessing performance. The Bank's HR Directorate owns the Bank's recruitment, training, competency and retention strategies. Succession planning is in place to maintain staffing and experience levels. Local management put forward appropriate budget and staff numbers for adequate resourcing of the RTGS and CHAPS services, which are approved and monitored under the Bank's governance arrangements. Staff are also subject to robust vetting.

Key consideration 2.6: The board should establish a clear, documented risk-management framework that includes the FMI's risk-tolerance policy, assigns responsibilities and accountability for risk decisions, and addresses decision making in crises and emergencies. Governance arrangements should ensure that the risk-management and internal control functions have sufficient authority, independence, resources, and access to the board.

Risk management framework

The Bank's enterprise-wide governance arrangements include a clear and documented risk management framework. The Bank's arrangements for risk management were described on

³⁷ Subsequent to the point of assessment, the Court of the Bank agreed changes to the governance of the RTGS Renewal Programme at their 21 September 2018 meeting. The new RTGS Renewal Committee is a sub-committee of Court responsible for overseeing delivery of the RTGS renewal programme, and for making key decisions on the overall scope of the programme, the procurement and spending, within the overall budget envelope agreed by Court. It has six members, two external members from each of Court and the RTGS/CHAPS Board, as well the Deputy Governor for Markets & Banking and the Bank's Chief Operating Officer.

pages 34-37 of the Bank's Annual Report for 2018.³⁸ A Bankwide risk tolerance statement was agreed by the Bank's Court in December 2015.

Generally, the Bank seeks to keep its exposure to risk low and aims to have a control environment and risk culture that supports this. There is a very low tolerance for operational risks which impact business-critical functions such as the operation of the RTGS and CHAPS services.

Consistent with these arrangements, the RTGS/CHAPS Board is responsible for setting the RTGS and CHAPS risk tolerances, consistent with the overall Bank risk tolerance, and overseeing the RTGS and CHAPS Risk Management framework. Whilst a new RTGS and CHAPS risk framework is in place, there is further work planned in 2018 to further enhancement this risk framework. This is covered in greater detail under *Principle 3-Framework for the comprehensive management of risks*.

Board Risk Committee is responsible for: monitoring the RTGS and CHAPS risk management framework, risk tolerance and risk profiles. Board Risk Committee also seeks to ensure that, where relevant, the RTGS and CHAPS risk management framework will operate in an aligned manner with the Bankwide risk framework.

Risk monitoring is performed through: continuous monitoring of the RTGS and CHAPS services; periodic reporting to Board and executive governance; regular penetration testing and other security testing; and regular updates on vulnerabilities. In respect of the CHAPS service, the Bank also undertakes assurance over the CHAPS Direct Participants to ensure they meet requirements for system participation.

An annual, externally-commissioned ISAE 3402 control audit considers whether the Bank meets certain specified controls for the RTGS service. This is in addition to internal audit and other risk and control reviews, and the Bank's internal operational risk and compliance function.

Authority and independence of risk management and audit functions

Risks arising to the operation of its RTGS and CHAPS responsibilities fall within the Bankwide risk framework. This Bankwide framework is considered at the Bank's Executive Risk Committee and Court's Audit and Risk Committee. Where appropriate, the Board will raise specific risk matters with the Bank's Executive Risk Committee.

³⁸ <https://www.bankofengland.co.uk/annual-report/2018>

The first line, the business area responsible for RTGS and CHAPS delivery, is responsible for owning the RTGS and CHAPS risks, developing and delivering the risk management framework and implementing controls as appropriate. It is in control of deploying local risk policies, tools and methods to effectively manage the risks. A Bankwide second line function is responsible for defining the Bank's overall risk management framework, as well as providing tools, support and challenge to the first line of defence. It reports into a different Deputy Governor, and the head of the relevant division also has a direct reporting line to the Audit and Risk Committee of the Bank's Court.

The Bank's third line (Internal Audit) provides assurance that the RTGS and CHAPS risk management framework is robust and that internal controls are appropriate and effective.

The RTGS/CHAPS Board Risk Committee is responsible for owning and approving the RTGS and CHAPS risk management framework and for reviewing the RTGS/CHAPS risk profile against the agreed tolerances. The review of the RTGS and CHAPS risk management framework is the responsibility of the Board Risk Committee, which will then make recommendations to the full Board. Where it considers appropriate the Board refers specific risk matters to the Bank's Executive Risk Committee.

The Board Risk Committee has agreed the interaction between the RTGS/CHAPS governance structure and Bank second line and the information flows between the two areas. The Board Risk Committee assesses the effectiveness of the RTGS/CHAPS risk management function. This includes whether it has sufficient authority, independence and resource, within the context of the operating model for RTGS and CHAPS, and the Bank's three lines of defence.

Board Risk Committee provides a recommendation to the Board on the adequacy and timeliness of the executive's proposed response to risk-based audit assessments. It also reviews whether the Bank's Internal Audit programme of review adequately reflects the key risks to RTGS and CHAPS and provides sufficient assurance on the activities of the first and second lines of defence and makes recommendations to Board based on this.

The Bank's overarching framework for crisis and incident management, based on a standard Gold, Silver and Bronze set of arrangements, is applied to RTGS and CHAPS. This framework is subject to continuous improvement, and provides clarity for decision making and information flows in emergencies that might affect the operation of the RTGS and CHAPS services. Parallel arrangements exist for a financial crisis that might, for example, include the resolution of an RTGS account holder (including a CHAPS Direct Participant).

Key consideration 2.7: The board should ensure that the FMI's design, rules, overall strategy, and major decisions reflect appropriately the legitimate interests of its direct and Indirect Participants and other relevant stakeholders. Major decisions should be clearly disclosed to relevant stakeholders and, where there is a broad market impact, the public.

The Bank, as operator of the RTGS and CHAPS services, considers the legitimate interests of RTGS account holders, including CHAPS Direct Participants, payment system operators and other relevant stakeholders. As the end-to-end, systemic risk manager for the CHAPS system, this includes the interests of indirect participants, end-users and the wider public of the safe and efficient operation of CHAPS to support monetary and financial stability as well as other public interests.

The Bank undertakes a range of layered engagement and communications with CHAPS users. One of the key channels for seeking input from CHAPS users is the CHAPS Strategic Advisory Forum, chaired by one of the external Board members. The purpose of the Strategic Advisory Forum is to support an ongoing and effective dialogue between the RTGS/CHAPS Board, the executive responsible for CHAPS, and a balanced set of senior and experienced users in respect of the CHAPS service. The forum is advisory, providing a user input into RTGS/CHAPS governance.

In addition, the Bank's executive meets with CHAPS Direct Participant representatives at strategic and operational levels on a range of topics, gathering input from the Direct Participants. The Bank also looks to engage with trade associations including the Law Society of England & Wales and the Association of Corporate Treasurers.

Through these channels, the interests of the participants and other users feed into decision-making at Board. For instance, the Board receives an update from the CHAPS Strategic Advisory Forum chair following every Forum meeting.

The Bank's RTGS Renewal Programme includes a significant engagement programme with key stakeholders. For example, the Bank published a detailed consultation on the adoption of the ISO 20022 messaging standard described in *Principle 22-Communication procedures and standards*. The Bank also set up an External Advisory Body, which includes a range of senior figures from the payment industry and other relevant stakeholders, to advise the Bank on the RTGS renewal programme. This follows the extensive consultation with a broad range of stakeholders across industry by the Bank ahead of the publication of the Blueprint for the future of the RTGS service in 2017.

The Bank is also subject to challenge from payment system operators and their directly-settling participants, and meets with them regularly to discuss the RTGS service and consults them on all material changes. The Bank, in its capacity as operator of the RTGS system, attends EUI's Settlement Bank Committee as an observer³⁹. Major decisions are cascaded to the payment system operators and relevant account holders, and communicated to the public where appropriate.

Disclosure

The Bank communicates and publishes information relating to relevant major decisions involving RTGS and CHAPS to relevant stakeholders including other payment system operators and their settlement participants, CHAPS Direct Participants, other RTGS account holders, market committees (such as the Bank's Money Markets Committee) and other channels as relevant. However, information relating to major decisions is only communicated externally to the extent that it would not, amongst other things, risk prejudicing the security and integrity of RTGS or CHAPS, the Bank and the financial system or release commercially sensitive information.

³⁹Following the assessment date, the Bank now attends Pay.UK's Participant Advisory Council as an observer

Principle 3-Framework for the comprehensive management of risks

An FMI should have a sound risk-management framework for comprehensively managing legal, credit, liquidity, operational, and other risks.

Scope and applicability: Applicable to the combined risk management arrangements for the RTGS and CHAPS services. Under the CPMI-IOSCO guidance note on application of the PFMI to central bank FMIs, Key Consideration 3.4 (recovery and wind-down) does not apply.

Rating: Broadly observed

Summary of compliance: The Bank as a whole has a clear high-level risk management framework operating with a standard three lines of defence model. Within the Bank-wide framework, RTGS/CHAPS determines the strategy and tolerance that applies for the RTGS and CHAPS services.

The RTGS/CHAPS Board determines the strategy for managing risk and the tolerance for risk. It takes the lead in setting a strong risk management culture and relies on a sound governance structure to ensure its risk management strategy is implemented through frameworks, policies and risk reporting. Board approves the Risk Framework and the Risk Tolerance Statements on an annual basis, or whenever there is a significant change to CHAPS and/or RTGS.

As of the assessment date of June 2018, the risk framework aligns CHAPS risk management to the Bank-wide risk management framework, and enables both a common language for articulating risks, and a set of common practices for the Bank's management and operation of the CHAPS payment system and the RTGS infrastructure. This framework is owned and annually reviewed by the RTGS/CHAPS Board and overseen by the RTGS/CHAPS Board Risk Committee.

As the systemic risk manager for CHAPS, the Bank seeks to undertake risk management on an end-to-end basis, drawing on the full set of tools and resources available to the Bank to identify, mitigate, and respond to risks as they emerge across the CHAPS ecosystem as a whole. In line with this approach, the risk framework covering RTGS and CHAPS will continue to evolve to adopt an increasingly holistic approach for RTGS and CHAPS, including the CHAPS system as a whole, not just the parts that the Bank is responsible for delivering.

In the early months since responsibility for CHAPS transferred to the Bank in November 2017, we have been able to address many of the structural deficiencies in relation to information sharing and control between RTGS and CHAPS. This is achieved through integrated teams, governance and risk management.

However, we plan a series of further enhancements over the upcoming months. And while we have undertaken early integration activities, there is more to be done to integrate and enrich our approach to risk management for RTGS and CHAPS. This is particularly the case for drawing on the tools and resources available from the wider Bank where it is too soon to reach a mature self-assessment of the risk reducing outcomes produced by the new, and yet to be implemented, risk management arrangements. The end-state of our enhanced framework is being designed for RTGS/CHAPS to enable us to act as an effective risk manager for CHAPS and RTGS, on an integrated basis.

Key consideration 3.1: An FMI should have risk-management policies, procedures, and systems that enable it to identify, measure, monitor, and manage the range of risks that arise in or are borne by the FMI. Risk-management frameworks should be subject to periodic review.

The primary risk to the RTGS and CHAPS services is operational risk. The Bank also considers a range of financial and other non-financial risks including credit, legal, and third party risks. Both CHAPS and the RTGS infrastructure follow a common risk taxonomy with the principle areas of risks identified as, but not limited to operational, conduct, strategic and reputational risk.

Risk management policies, procedures and systems

The Bank's Court of Directors reviews the effectiveness of the risk management and internal control systems. Court determines the strategy for managing risk and the Bank's tolerance for risk. A Bank-wide risk tolerance statement is approved by Court and sets out the extent of financial, operational and policy implementation risk that the Bank is willing to accept. Executive Directors and Directors certify compliance with the wider Bank's risk management and internal controls, including reviewing the risk and control issues identified and reported during the year.

There is an RTGS and CHAPS risk management framework agreed by the RTGS/CHAPS Board. It sets out the system of risk management for the Bank's delivery of the RTGS and CHAPS services, including how the RTGS/CHAPS governance and the three lines of defence model are implemented within the context of the wider Bank governance and risk

management. It is intended to ensure that risks impacting RTGS and CHAPS are identified, assessed, and monitored, reported, controlled and mitigated appropriately, including operational, policy implementation and financial risks impacting the RTGS and CHAPS services.

Risks are managed through an overarching documented risk management framework that is reviewed to ensure risk management policies, systems and procedures are effective. It is also intended to apply consistency and transparency of risk management. It will ensure suitable mitigating actions are developed for those internal and external exposures deemed out of tolerance. Risks are identified, measured, monitored and managed via a variety of forward and backward looking processes such as including horizon scanning as well as stress testing and scenario analysis.

Risks are categorised via the Bank's risk taxonomy and rated for impact and likelihood, with tolerances set to ensure aggregated risk exposure is understood and risks are managed to within specified tolerances. Regular risk reporting takes place across the three lines of defence and is used by the executive to monitor risks.

Review of risk management policies, procedures and systems

The Bank operates a standard three lines of defence model. Responsibility for enacting, oversight and review of the RTGS/CHAPS risk management function is allocated according to the three lines of defence model.

The Bank's Audit and Risk Committee (ARCo), a committee of Court, assists Court in meeting its responsibilities for an effective system of financial reporting, internal control and risk management. It oversees the Bank's Internal Audit programme for the year, and is responsible for reviewing the findings for internal and external auditors and monitoring outstanding actions for timely completion. ARCo receives reports on the Bank's risk profile, the operation of the risk framework and the risk management processes and systems in place in the Bank. The Chair of ARCo, one of the Bank's Non-executive Directors, is responsible for the performance of ARCo, and for ensuring and overseeing the integrity of the independence of the Bank's risk functions.

Internal Audit seeks assurance that internal controls, risk management and governance processes are operating effectively. Internal Audit also attend (but it not a member of) RTGS/CHAPS Board and Board Risk Committee.

The first line, which sits within the area operating RTGS/CHAPS, is responsible for owning the risks and implementing controls as appropriate. It is in control of deploying local risk policies, tools and methods to effectively manage the risks.

The Directorate that delivers the RTGS and CHAPS service has a team focused on operational risk and compliance which works with the area delivering the RTGS and CHAPS services to identify and manage operational, delivery risks relating to RTGS and CHAPS.

The Bank's second line is responsible for defining and maintaining non-financial risk management frameworks and policies and reviewing RTGS/CHAPS risks. It provides supporting tools and challenge to the first line of defence's operation of the risk framework.

Credit risk management is part of the responsibilities of a separate team which works with the area delivering the RTGS and CHAPS services to analyse and control all financial risks. Risk decisions are subject to individual challenge by a second line function responsible for holistic assessment and forward-looking challenge on overall financial risks to the Bank's balance sheet.

The RTGS/CHAPS Board Risk Committee is responsible for owning, approving the risk management framework and for reviewing the RTGS/CHAPS risk profile against the agreed tolerances. The RTGS/CHAPS Board Risk Committee is also responsible for reviewing and proposing potential changes to the risk management frameworks, and/or the RTGS/CHAPS risk tolerance. These proposals are evaluated by the RTGS/CHAPS Board.

In certain circumstances risk matters will be escalated to the Bank-wide second line committee, the Bank's Executive Risk Committee (ERC). This will be the case in the event that RTGS/CHAPS Board Risk Committee or RTGS/CHAPS Board considers risks within the RTGS and CHAPS services to exceed tolerance, and in particular requires changes to Bank-wide policies to return risks to within tolerance.

The Bankwide Risk Division (BRD) attends (but is not a member of) RTGS/CHAPS Board Risk Committee. ERC, as part of its Bank-wide responsibilities, is responsible for monitoring RTGS/CHAPS risk profile against tolerance. The RTGS/CHAPS Board Risk Committee has agreed the interaction between the RTGS/CHAPS governance structure and Bank-wide second line and the information flows between the two areas.

The risk management framework is regularly reviewed to determine its effectiveness at Board level. This will look at all aspects of the framework, with a particular focus on ensuring that the risk tolerances remain appropriate.

Key consideration 3.2: An FMI should provide incentives to participants and, where relevant, their customers to manage and contain the risks they pose to the FMI.

All account holders in RTGS, including CHAPS Direct Participants are subject to appropriate prudential supervision. The Bank's requirements on account holders include evidencing a sufficient level of technical capability and operational resilience. The Bank does not currently levy any penalties directly in respect of settlement agent activities, but will levy interest if, for example, an intraday loan is unable to be repaid.

CHAPS participant performance – assurance and non-compliances

The CHAPS participant assurance function reviews the risks posed to the CHAPS system from Direct Participants and seeks assurance and evidence of how DPs are managing these risks, and the risks posed to them. The model for CHAPS participant assurance uses a self-assessment process of compliance against the CHAPS Reference Manual and attestation from each DP. This is complemented by targeted information requests including, for example, on tiering data and follow-up questions from the self-assessment process. This picture is also completed by information on, for example, live incidents. The CHAPS consequence management framework set out how non-compliances are managed, including agreeing a path back to compliance and escalation if required. Further information on the CHAPS participant assurance is set-out under *Principle 18-Access and participation requirements*.

The Bank, as operator of CHAPS, holds regular bilateral and multilateral meetings with CHAPS Direct Participants, which provides an opportunity to discuss risks posed to CHAPS by the Direct Participants and how these are managed. All rules and requirements CHAPS Direct Participants are required to comply with are set out in the published CHAPS Reference Manual, supported by operational and technical requirements.

Tools to support risk management

The Bank, as operator of RTGS and CHAPS, uses a real-time dashboard to monitor operational performance. A similar dashboard makes live information available to CHAPS DPs to help them manage their liquidity risk. The RTGS system also has several features that incentivise account holders to manage their risks. This includes a Liquidity Saving Mechanism (LSM), providing a more liquidity efficient method for making non-urgent CHAPS payments. DPs are incentivised to submit their CHAPS payments as early as possible to allow the greatest possibility of liquidity savings – which also reduces operational and systemic risks which in turn promotes financial stability. In addition to this the Bank sets

throughput targets for CHAPS Direct Participants, varying by category, and monitors adherence to these agreed targets.

Key consideration 3.3: An FMI should regularly review the material risks it bears from and poses to other entities (such as other FMIs, settlement banks, liquidity providers, and service providers) as a result of interdependencies and develop appropriate risk-management tools to address these risks.

Material risks in relation to other entities

Key stakeholders that rely on RTGS are Euroclear UK and Ireland (regarding the operation of the CREST system) and Pay.UK (regarding the multilateral settlement of the net obligations arising from Bacs, the Faster Payment Service and the paper and Image Clearing schemes), LINK Scheme Limited and Visa Europe.

The risk register for RTGS/CHAPS includes risks borne to RTGS and CHAPS from other entities. The Bank has a formal process to identify and monitor these risks.

Contingency procedures are in place for settlement of payment systems in the event of an operational incident. Individual transactions in CREST and the retail payment systems can continue to be processed in the event of an RTGS outage, but financial and operational risks may increase in the event of a prolonged outage. These procedures are reviewed and tested on a regular basis and detailed under the assessment of *Principle 17-Operational risk*. However, CHAPS payments cannot be made between banks unless the RTGS Service is available (see the self-assessment under *Principle 17 – Operational risk* for business continuity arrangements) The Bank, as RTGS operator, holds at least quarterly liaison meetings with each of the payment system operators in which any relevant changes in risk profiles and resulting impacts are discussed. The Bank also collaborates with a number of other key stakeholders in assessing the resilience of RTGS, the payment systems and the wider UK financial infrastructure. Regarding physical and cyber security, the Bank closely collaborates with EUI, SWIFT and the relevant UK authorities, such as National Cyber Security Centre, to ensure appropriate logical and physical controls are available and implemented.

The enhanced systemic risk management framework is designed to capture the risks to the wider RTGS/CHAPS ecosystem. Therefore, risks arising in relation to other entities will form an integral part of the standard risk register and associated tools when the enhanced framework is fully embedded. The governance structure and frequency of review for the enhanced framework will follow the same procedures as described above.

Risk management tools in relation to other entities

The predominant risks arising from and to RTGS and the wider Bank are tracked on the RTGS/CHAPS risk report and underlying risk tools as described above. They are therefore reviewed by RTGS/CHAPS Risk Committee and Board on this basis. As an end-to-end systemic risk manager for CHAPS, this will include all risks arising from and to the CHAPS ecosystem. The risk report, emerging risk register and key risk indicators form the tools that the executive and Board Risk Committee use to monitor and review risks to RTGS/CHAPS. The tools themselves have been reviewed and agreed by RTGS/CHAPS Board.

A supplier assessment framework exists for all companies that provide technology or services to RTGS to ensure they do not pose a risk to resilience. The self-assessment against *Key Consideration 17.7* includes an assessment of the risks posted to the Bank, as operator of RTGS, from other organisations. The Bank also reviews the arrangements in place with organisations identified as critical service providers to the CHAPS system.

Principle 4-Credit risk

An FMI should effectively measure, monitor, and manage its credit exposures to participants and those arising from its payment, clearing, and settlement processes. An FMI should maintain sufficient financial resources to cover its credit exposure to each participant fully with a high degree of confidence.

Scope and applicability: Under the CPMI-IOSCO guidance note on application of the PFMI to central bank FMIs, the PFMI are not intended to constrain central bank policies on provision of credit by the central bank, or the terms of or limits on such provision. Credit risk is predominantly only relevant when considering the Bank's role in operating RTGS, although a de minimis amount of credit risk remains in relation to the Bank's operation of the CHAPS system.

Rating: Observed

Summary of compliance: The Bank, as operator of RTGS and CHAPS, is not exposed to any material current or future credit exposures other than through the provision of liquidity against collateral, which is secured against the very highest quality collateral, and the non-payment of the RTGS/CHAPS tariff.

Key consideration 4.1: An FMI should establish a robust framework to manage its credit exposures to its participants and the credit risks arising from its payment, clearing, and settlement processes. Credit exposure may arise from current exposures, potential future exposures, or both.

Risk standards and frameworks are created and owned centrally for risks to the Bank's balance sheet. The Bank-wide risk framework is reviewed on an annual basis.

The area of the Bank that operates the RTGS and CHAPS services adheres to these and provides an annual sign-off of compliance. This includes standards for the mitigation of credit risk to the Bank. A dedicated second-line financial risk division monitors all of the Bank's credit exposures as part of a 'three lines of defence' framework.

Key consideration 4.2: An FMI should identify sources of credit risk, routinely measure and monitor credit exposures, and use appropriate risk-management tools to control these risks.

Exposure through settlement

The nature of RTGS settlement fully eliminates credit risk between account holders. As settlement occurs in real-time, there are no intraday exposures built up between RTGS account holders through use of RTGS. RTGS requires sufficient liquidity to be in place before settlement can take place. This applies both to bilateral settlement, such as CHAPS, as well as the multilateral settlement used for the retail payment systems, although in the latter case exposures build up outside RTGS.

No direct credit risks are posed to the Bank from settlement across accounts in RTGS. The Bank, as operator of RTGS, neither guarantees transfers to meet payment obligations, nor allows overdrafts that would permit payments to settle if the account holder lacks liquidity (for CREST see below). This is understood by RTGS account holders and payment system operators and reflected in the relevant legal documentation.

There are system checks built into RTGS that prevent account holders from becoming overdrawn. The Bank monitors credit exposure through setting and enforcing a zero overdraft on all account groups.

In the event of a default of an RTGS account holder (including a CHAPS Direct Participant), procedures exist to prevent further transfers being carried out through RTGS, including CHAPS payments (where applicable) (see *Principle 13 – Participant default rules and procedures*).

In the event of the Bank's tertiary site, MIRS, being invoked, no additional credit or settlement risk is posed to the payment systems settling in RTGS. Settlement would restart with the same intraday liquidity positions. These positions are then unwound manually at the end of the day; this process is automated in business-as-usual operations.

Exposure through liquidity provision

The key credit exposure from the Bank's operation of RTGS is through liquidity provision. Only SMF Participants that are CHAPS Direct Participants can generate intraday liquidity, and CREST settlement banks can generate auto-collateralising repo to meet their liquidity needs in the course of the settlement day. Such liquidity provision is secured against the very highest quality collateral (known as 'Level A') and, in all normal circumstances, is intraday. The relevant framework is described in detail in the Bank's Red Book.⁴⁰ Section VII of the Red Book lists the eligible collateral, the haircut principles and the daily valuation process.

⁴⁰ [The Bank of England's Sterling Monetary Framework](#)

All institutions eligible for intraday liquidity in RTGS, i.e. SMF participants, are subject to appropriate prudential supervision. The operational areas of the Bank also monitor the credit worthiness of these institutions through internal risk assessment processes.

The Bank may provide contingency arrangements to turn this intraday exposure into an overnight exposure in the event of an operational or liquidity issue. In the unlikely event of an operational error in CREST resulting in a negative earmark being received in RTGS that cannot be covered from a relevant account, the Bank has a procedure in place to ensure that any credit risk incurred from such an error is effectively mitigated through the Operational Error Lending Scheme (OELS). This can arise from the Bank's irrevocable and unconditional undertaking, to debit paying CREST settlement banks and credit payee CREST settlement banks, which underpins CREST settlement.

Haircuts

The Bank takes only the very highest quality collateral, to which it applies prudent haircuts to control for market risk and minimise the arising credit risk exposure (see *Principle 5 – Collateral*). While the provision of intraday liquidity can have financial and monetary stability benefits, the Bank must also protect its balance sheet. Reserves are the principal source of liquidity held at the Bank. In the unlikely event that a credit risk materialised, the Bank could use these reserves to cover any shortfall.

There is no value limit on intraday liquidity generation. Such credit is, however, limited by the value of Level A collateral that each participant holds, subject to appropriate haircuts.

Haircuts are designed to be sufficient to cover intraday price movements. If these haircuts were found to be insufficient, there is a process for calling margin on liquidity provision including any that has been rolled overnight.

Managing concentration risk

The Bank monitors the level of liquidity generation and retains a right to exercise discretion to limit it, if deemed necessary. The Bank is also able to set a limit on auto-collateralising repo generation in CREST, though has not so far judged it necessary to do so. The positions are unwound automatically.

The Bank has the discretion to require counterparties to provide collateral diversified across a number of issuers. However, the acceptance of only the very highest quality collateral by a small number of issuers means that the Bank in practice has concentrated holdings of collateral. As outlined above, the assets accepted are of very high quality and have deep,

liquid markets. The concentrated holding of these assets should not normally impair the Bank's ability to liquidate these assets quickly without significant price effects.

Key consideration 4.3: A payment system or SSS should cover its current and, where they exist, potential future exposures to each participant fully with a high degree of confidence using collateral and other equivalent financial resources (see Principle 5 on collateral). In the case of a DNS payment system or DNS SSS in which there is no settlement guarantee but where its participants face credit exposures arising from its payment, clearing, and settlement processes, such an FMI should maintain, at a minimum, sufficient resources to cover the exposures of the two participants and their affiliates that would create the largest aggregate credit exposure in the system.

Operating RTGS does not expose the Bank to any material current or future credit exposures other than through the provision of liquidity against collateral and the non-payment of the RTGS/CHAPS tariff in the highly unlikely event that there are insufficient funds on their settlement account to recover the tariff.

As the Bank does not accept direct credit risk, there is no requirement for the Bank to hold resources to cover potential exposure to account holders. See the self-assessment against *Principle 5-Collateral* for how the Bank manages residual exposures associated with collateral.

A dedicated second line financial risk division monitors all of the Bank's credit exposures as part of a 'three lines of defence' framework. The Bank has a framework, which sets the standards for the Bank's exposures relative to the Bank's capital, consistent with the Bank's overall risk tolerance. There is a clear framework for remediation of breaches, with mechanisms for challenge.

The Bank encourages and supports payment system operators and their participants to manage credit exposures incurred within their systems. For example, the Bank implemented cash prefunding for Bacs, Faster Payments and the Image Clearing Scheme enabling a fully funded, 'defaulter pays' model to eliminate credit risk between the directly-settling participant in each system.

Key consideration 4.7: An FMI should establish explicit rules and procedures that address fully any credit losses it may face as a result of any individual or combined default among its participants with respect to any of their obligations to the FMI. These rules and procedures should address how potentially uncovered credit losses

would be allocated, including the repayment of any funds an FMI may borrow from liquidity providers. These rules and procedures should also indicate the FMI's process to replenish any financial resources that the FMI may employ during a stress event, so that the FMI can continue to operate in a safe and sound manner.

RTGS Terms & Conditions and associated CREST documentation set out the arrangements in the event of a participant default in RTGS, including the insolvency of an account holder. These detail the bilateral close-out and set-off provisions. There are no exposures between account holders in RTGS by virtue of holding an account in RTGS and so there are no mutualised loss-sharing arrangements between account holders that would require allocation of losses. More broadly, there are standardised Bank-wide procedures for the management of default. Further information is under the self-assessment against *Principle 13-Participant default rules and procedures*.

Any credit losses due to non-payment or under-collateralisation would be recovered through the collection from RTGS accounts. This right is set out in the RTGS Terms & Conditions. As any credit exposures are generally low relative to the RTGS account balances, this will ensure any credit exposures can be fully recovered. Credit exposures arising from the historic provision of services, such as unpaid accrued fees, would be for negligible amounts.

Principle 5-Collateral

A payment system that requires collateral to manage its or its participants' credit exposure should accept collateral with low credit, liquidity, and market risks. A payment system should also set and enforce appropriately conservative haircuts and concentration limits.

Scope and applicability: Under the CPMI-IOSCO guidance note on application of the PFMLs to central bank FMIs, the PFMLs are not intended to constrain policies on what can be accepted as eligible collateral in central bank lending operations. Principle 5 - Collateral is only relevant to the Bank in its role as operator of RTGS as no collateral is taken in the operation of CHAPS.

Rating: Observed (RTGS); Not applicable (CHAPS)

Summary of compliance: The Bank provides intraday credit for liquidity purposes on a fully collateralised basis, in order to settle obligations in payment and settlement systems. The Bank accepts only the very highest quality collateral and sets prudent margins. By requiring the very highest quality collateral, the Bank ensures the collateral it accepts has deep and liquid markets. Because of this there is no need for a limit on the extent to which collateral is concentrated in certain securities.

Key consideration 5.1: An FMI should generally limit the assets it (routinely) accepts as collateral to those with low credit, liquidity, and market risks.

The Bank provides intraday credit for liquidity purposes, in order to settle obligations in payment and settlement systems. Acceptable collateral to secure intraday liquidity is drawn from a list of the highest rated sovereign and central bank debt, with low credit, liquidity and market risk. This is known as 'Level A' collateral. This approach is set out publicly in the Bank's 'Red Book', which describes the Sterling Monetary Framework, and the list of Level A collateral is published on the Bank's website.⁴¹ The Bank also accepts euro-denominated central bank money as intraday liquidity collateral. The auto-collateralising repo mechanism for CREST is secured against gilts, Treasury bills and sterling bills issued by the Bank.

The list of Level A collateral is reviewed annually and is subject to second line challenge under the Bank's 'three lines of defence' model for financial risk management of the Bank's balance sheet. The Bank continually monitors the range of securities it accepts as collateral in its operations and can make ad hoc changes if necessary. The Bank's collateral

⁴¹ See <http://www.bankofengland.co.uk/markets/Pages/money/eligiblecollateral.aspx>.

management system will only use collateral that is specified as 'Level A' for intraday liquidity generation.

As the Bank only accepts the very highest quality collateral, the default of an account holder should not impact the value of the collateral, and wrong-way risk is largely mitigated. Collateral is monitored at the account holder level, meaning that the Bank can require counterparties to provide collateral diversified across a number of issuers to help mitigate wrong-way risk if further protection is deemed necessary.

Key consideration 5.2: An FMI should establish prudent valuation practices and develop haircuts that are regularly tested and take into account stressed market conditions.

The Bank applies conservative haircuts to all collateral used to secure the provision of intraday collateral to minimise the chance of under-collateralisation. Collateral is marked to market on a daily basis. 'Level A' collateral only includes certain government securities with deep and liquid markets. The Bank is the pricing agent.

A dedicated first line financial risk management function analyses and controls risks from the securities held as collateral including the undertaking of valuation and haircut practices and coordinating their review. Haircuts are reviewed regularly and are subject to independent second line challenge. Haircuts, and which collateral is accepted, can also be adjusted in response to changes in market conditions and the underlying risks. The Executive Director for the Markets Directorate is responsible for haircut policy and can exercise discretion in stressed scenarios. The aim of the framework is to deliver valuation and haircut practices that are prudent and robust.

Key consideration 5.3: In order to reduce the need for procyclical adjustments, an FMI should establish stable and conservative haircuts that are calibrated to include periods of stressed market conditions, to the extent practicable and prudent.

In order to take into account potential stress events when calibrating haircuts, modelling is done using the most volatile two-year period since 1999 or the earliest year from which data are available. This long-term view takes into account the potentially procyclical nature of collateral requirements and means the Bank's haircuts are broadly stable through changing market conditions.

Calculations of haircuts are based around extreme price moves over the holding period. Changes in the liquidity of this collateral are not modelled explicitly, but market liquidity conditions are captured within the historical periods of market stress used. Furthermore, a

conservative holding period assumption provides a further cushion as this collateral is of the very highest quality and intended to be held on an intraday basis only.

Key consideration 5.4: An FMI should avoid concentrated holdings of certain assets where this would significantly impair the ability to liquidate such assets quickly without significant adverse price effects.

The acceptance of only the very highest quality collateral by a small number of issuers means that the Bank has concentrated holdings of collateral and is potentially exposed to concentration risk. The assets accepted are of very high quality and have deep, liquid markets. The concentrated holding of these assets should not normally impair the Bank's ability to liquidate these assets quickly without significant price effects.

The Bank-wide Risk Management Framework is reviewed annually. Policies relating to operation of the Sterling Monetary Framework, as described in the Red Book, are reviewed on a regular basis, at least annually. This will include the concentration risk policies relating to collateral held to secure against the provision of intraday liquidity, which are reviewed annually and subject to an internal second line review.

The Bank's general preference is to accept the concentration risk outlined above – and not set concentration limits – rather than widen the pool of issuers and accept increased credit, liquidity and market risks.

Key consideration 5.5: An FMI that accepts cross-border collateral should mitigate the risks associated with its use and ensure that the collateral can be used in a timely manner.

The Bank accepts sovereign or central bank securities in certain non-sterling currencies. The haircuts applied, alongside the depth and liquidity of the markets for 'Level A' collateral, are deemed sufficient to mitigate the associated risk, including pricing risk. This collateral is accepted through delivery to the Bank's account at the home central bank, in the issuing Central Securities Depository (CSD), or through accredited CSD links. This mitigates the operational risks associated with the use of cross-border collateral.

Collateral is held in the Bank's name through transfer of title, not 'on behalf of' the relevant RTGS account holder. The terms on which the Bank receives and holds collateral ensure it can be used in a timely manner during RTGS operating hours.

Key consideration 5.6: An FMI should use a collateral management system that is well-designed and operationally flexible.

Collateral management system design

The key functionality of the Bank's collateral management system is a single collateral pool which allows account holders to manage their own collateral and the Bank to monitor margin, where exposures to counterparties are collateralised, in real-time. The system also offers straight through processing and a browser-based portal for participants to manage their activity.

As the Bank does not re-hypothecate collateral, there is no risk of re-use of collateral used to cover its exposures. Therefore, the re-use of collateral and the Bank's rights to the collateral are not tracked within the collateral management system.

Operational flexibility

The collateral management system configuration can be easily altered to accommodate changes in the criteria for managing collateral and associated exposures. The system was designed with such flexibility in mind, with the ability to introduce new operations as well as to change the rules that dictate existing facilities. The Bank has a dedicated team that manages the configuration to ensure that it correctly captures the current and/or any changing requirements.

Collateral management activities for RTGS are tracked and reported to management. The Bank ensures that there are sufficient resources to maintain the operation of its collateral management system at a high standard. Collateral operations are staffed on a split site basis and use dual data centres to ensure smooth operations.

Principle 7-Liquidity risk

An FMI should effectively measure, monitor, and manage its liquidity risk. An FMI should maintain sufficient liquid resources in all relevant currencies to effect same-day and, where appropriate, intraday and multiday settlement of payment obligations with a high degree of confidence under a wide range of potential stress scenarios that should include, but not be limited to, the default of the participant and its affiliates that would generate the largest aggregate liquidity obligation for the FMI in extreme but plausible market conditions.

Scope and applicability: The liquidity risk principle is relevant to CHAPS as a payment system. Whilst the Bank takes on no liquidity risk as part of its operation of CHAPS, as a systemic risk manager the Bank monitors the extent to which liquidity risk arises between CHAPS Direct and Indirect Participants and seeks to mitigate it where possible and proportionate. Hence only Key Considerations 7.1 and 7.2 are relevant to the Bank as operator of CHAPS.

The Bank does not require liquidity to operate RTGS. The Bank is not a party to transfers between account holders, nor does the Bank provide a financial guarantee to underpin settlement. As the sterling central bank of issue, the Bank is not liquidity constrained and would not face a shortfall. Therefore, this Principle is not applicable in relation to RTGS.

However, the Bank does provide intraday liquidity and other arrangements to support timely settlement to CREST settlement banks and settlement participants in prefunded retail systems.

- *For CREST, the Bank provides intraday liquidity to CREST settlement banks through auto-collateralised repo to help optimise the amount of liquidity committed to CREST.*
- *For Bacs, Faster Payments and the Image Clearing Scheme, Pay.UK requires cash prefunding – directly-settling participants must hold cash sufficient to cover their largest net position in each system with the Bank in special ‘prefunding accounts’. These balances would be used to complete settlement in the event of default.*

Rating: Observed (CHAPS); Not applicable (RTGS)

Summary of compliance: As an end-to-end systemic risk manager (see Principle 3-Framework for the comprehensive management of risks), the Bank monitors the potential for liquidity risk arising between the Direct and Indirect Participants in relation to the CHAPS system. Tools used to manage tiering risk within the system include the LSM and monitoring against the CHAPS throughput criteria.

Key consideration 7.1: An FMI should have a robust framework to manage its liquidity risks from its participants, settlement banks, nostro agents, custodian banks, liquidity providers, and other entities.

The Bank takes on no liquidity risk itself in the operation of CHAPS. Within the CHAPS system, the Bank primarily seeks to manage liquidity risk between CHAPS Direct Participants (DPs) via the throughput criteria and through the operation of the Liquidity Saving Mechanism (LSM).

The CHAPS throughput criteria are a target for the proportion of payments to be made by value by certain times in the settlement day. The Throughput Criteria set out certain criteria, principles, expectations and other matters to which the Bank, as operator of the CHAPS payment system, is required to have due regard and give due weight. With certain exemptions (FMIs, NBPSPs and the smallest banks) DPs are required to have settled (by value and averaged over each calendar month) their 'target'. For non-exempt institutions this target is 50% of payments by 12pm, 75% by 3pm and 90% by 5pm, with tolerances dependent on the systemic importance of the relevant participant. This seeks to ensure that payments should not be unnecessarily delayed and receipt-reactive behaviour, i.e. where DPs wait to receive incoming payments before making their own, is limited.

The Bank introduced the LSM in April 2013 to provide a liquidity management tool for DPs. The LSM matches queued non-urgent payments for simultaneous, off-setting settlement. By matching and settling payments in this way the amount of liquidity required in the system reduced.

For the end-to-end CHAPS system, the Bank seeks to manage liquidity risk through the tiering rules, supported by an analysis of tiered concentration risk. The CHAPS rules state that an indirect relationship may be prohibited if an indirect participant's average daily payment activities exceed either: (i) 2% of the average total payment activity, by value, processed each day; or (ii) 40% of the average daily value of its settlement bank's own payments. CHAPS Indirect Participants may consider that their CHAPS Direct Participant is a provider of unsecured credit facilities under all conditions, both business-as-usual and stressed. Conversely, CHAPS Direct Participants may depend on the credit balances created by their Indirect Participants for their own intraday liquidity needs. The tiering criteria set out in the CHAPS Reference Manual looks to assess the levels of concentration risk and mitigate the risk through exploring the possibility of moving institutions from indirect to direct participation, where appropriate.

Key consideration 7.2: An FMI should have effective operational and analytical tools to identify, measure, and monitor its settlement and funding flows on an ongoing and timely basis, including its use of intraday liquidity.

The Bank's business intelligence system can display statistics on all CHAPS flows across RTGS in easily customisable tables. The Bank uses this information in its own analysis, and provides each DP with access. This system contains information on CHAPS Indirect Participants within their own BIC, which allows partial monitoring of exposures between Direct and Indirect Participants. Data are also provided externally from DPs regarding their internal flows which do not settle across RTGS as CHAPS payments.

The liquidity analysis undertaken by the Bank feeds into the regular throughput reporting alongside stress test scenarios. If a DP fails to comply with the throughput rules and outside agreed tolerance levels, remediation actions or mitigation are agreed.

In specific, usually stressed, scenarios, some monitoring can be undertaken in real-time. Stress testing is also performed including using scenarios such as an outage, suspension or exclusion of a DP.

The Bank also monitors CHAPS values for Indirect Participants to identify any (presumptive) breach of the CHAPS tiering criteria (see *Principle 19 – Tiered participation risks*). If a CHAPS Indirect Participant is large enough to present a liquidity risk to the system, the Bank can encourage them to join directly. In extremis, the Bank can withdraw consent for the sponsoring CHAPS Direct Participants to process CHAPS payments on behalf of the relevant Indirect Participant.

Principle 8-Settlement finality

An FMI should provide clear and certain final settlement, at a minimum by the end of the value date. Where necessary or preferable, an FMI should provide final settlement intraday or in real time.

Scope and applicability: CHAPS is a payment system designated by the Bank under the Financial Markets and Insolvency (Settlement Finality) Regulations 1999.

The RTGS system is not a payment system itself: rather it is the infrastructure that permits the final settlement of the obligations, arising from payments and securities transactions, across accounts at the central bank. Furthermore, the RTGS system is neither an interbank payment system for the purposes of the Banking Act 2009, nor is it designated under the Financial Markets and Insolvency (Settlement Finality) Regulations 1999.

However, as well as CHAPS, some of the other UK payment systems that settle across accounts in RTGS are also designated under the Financial Markets and Insolvency (Settlement Finality) Regulations 1999: Bacs, Cheque & Credit (paper and image clearing), CLS, the embedded payment arrangements within CREST, and Faster Payments. Furthermore, UK central counterparties have also designed their sterling payment arrangements as to be settled through CHAPS and CREST, and such payment arrangements are themselves so designated: ICE Clear Europe, LCH.Clearnet Limited, LME Clear Limited and SIX x-clear. As a consequence, where a system is designated, the payment 'transfer orders' executed within that system and settled through the RTGS system benefit from statutory protections under the Financial Markets and Insolvency (Settlement Finality) Regulations 1999.

As part of the work to extend RTGS access to non-bank PSPs, in January 2018 HM Treasury extended the scope of the Settlement Finality Regulations to include non-bank PSPs. For non-designated arrangements (LINK, Visa and settlement of positions from the Notes Circulation Scheme) and internal transfers within RTGS that do not originate from a designated system, protection is at a contractual level, for example, the RTGS Terms & Conditions and relevant documentation owned by the payment system operator.

Rating: Observed (RTGS and CHAPS)

Summary of compliance: The RTGS Service provides settlement in real time. The point of settlement finality is clearly defined for CHAPS payments in the CHAPS Reference Manual and for all other payments in the RTGS Reference Manual. This information is available to

all participants and sufficiently advanced potential participants. Arrangements in contingency situations, where links to SWIFT are not available, are also specified.

CHAPS is a designated system under the Financial Markets and Insolvency (Settlement Finality) Regulations 1999 (SFR). The Bank, as CHAPS operator, relies on sound legal opinions regarding the applicability of settlement finality in those jurisdictions where the Bank cannot rely on statutory settlement finality protection.

Key consideration 8.1: An FMI's rules and procedures should clearly define the point at which settlement is final.

Point of finality of settlement

For all RTGS settlement instructions (including CHAPS payments), finality of settlement is set out in the RTGS Reference Manual, both in normal operations and in contingency scenarios.

For each type of settlement instruction in RTGS, finality occurs at a different point and is defined in the RTGS Reference Manual. In normal circumstances finality of settlement is:

- For urgent CHAPS payments, the finality of settlement is at the point the settlement response has been stored by SWIFT.
- For non-urgent CHAPS payments, i.e. payments matched in the Liquidity Saving Mechanism, finality of settlement is at the point at which all messages marked for settlement related to a specific cycle have been stored by SWIFT.
- For payment systems that settle on a deferred basis, finality of the multilateral net settlement is the point at which the settlement confirmation has been stored by SWIFT.
- In CREST, finality of settlement is within the infrastructure operated by EUI. The CREST payment that discharges the buyer's obligation to the seller is supported by an irrevocable undertaking by the Bank to debit the buyer's CREST settlement bank and credit the seller's CREST settlement bank.
- Finality of settlement for so-called 'non-CHAPS transfers' is at the point the relevant settlement confirmation has been stored by SWIFT. Such transfers include the transfers that account holders may make between their own accounts and interest credits to reserves accounts. A full list is set out in the RTGS Reference Manual.

In a contingency, if MIRS is active, finality is when the payer's account is debited and the payee's account is credited.

Key consideration 8.2: An FMI should complete final settlement no later than the end of the value date, and preferably intraday or in real time, to reduce settlement risk. An LVPS or SSS should consider adopting RTGS or multiple-batch processing during the settlement day.

Final settlement on the value date

The RTGS service provides settlement in real-time. RTGS provides same-day settlement for CHAPS and other settlement instructions. CHAPS payments may be submitted to RTGS for settlement between 06:00 and 18:00. CHAPS Direct Participants submit CHAPS payments on their value date for same day settlement.

For CHAPS payments, the timing of payments is subject to constraints controlled by the relevant account holders, such as available liquidity, and their own internal exposure limits between each other, including those defined through the Bank's Liquidity Saving Mechanism.

The RTGS service also provides same-day settlement on the value date for systems where multilateral net obligations are settled on a deferred basis relative to the clearing of gross bilateral payments. These deferred settlements are scheduled at fixed points during the RTGS day, but may settle later than planned if there are operational delays or if an account holder lacks sufficient funds. The Bank can support multiple settlements per day per system. For example, Faster Payments currently settles three times per business day.

The Bank, as RTGS operator, seeks to settle all settlement instructions received on the same day. Any payments that are not settled, either due to lack of funds or operational error, are automatically cancelled by the Bank. Sending institutions may resubmit them the next business day.

In the event of an issue, a CHAPS/RTGS extension may be requested to provide up to an extra two hours (i.e. until 20:00) for final settlement to occur on the value date. Any extension to operating hours is exceptional and can provide additional time to ensure settlement takes place. Extensions are also covered under the self-assessment against *Principle 17 – Operational risk*.

Key consideration 8.3: An FMI should clearly define the point after which unsettled payments, transfer instructions, or other obligations may not be revoked by a participant.

Most settlement instructions submitted to RTGS, including all CHAPS payments, can be unilaterally revoked up to the point of finality of settlement. For example, payments queuing in the Liquidity Saving Mechanism (LSM) can be cancelled.

For payments made in error, the relevant payment service provider would need to agree to return the funds through the creation of a new (equal and opposite) payment.

Settlement instructions relating to CREST and the deferred net settlement systems have their point of irrevocability defined in the rules and procedures relevant to that system, and this can differ significantly from the point of finality of settlement. For example, for Bacs the point of irrevocability is defined as the extraction cut-off on input day i.e. the first day of the three day cycle for Bacs payments. Settlement takes place on the third day of the cycle.

CHAPS Direct Participants outside the EEA

CHAPS is a designated system under the Financial Markets and Insolvency (Settlement Finality) Regulations 1999 (SFR).

In relation to non-bank payment service providers, the RTGS Settlement Account Policy and CHAPS access criteria current only permit FCA-authorized non-bank payment service providers.

CHAPS payments made by non-EEA CHAPS Direct Participants are not covered by the protections arising from the settlement finality regulations. However, the Bank seeks to ensure that the level of risk (given the absence of statutory protection) is not inconsistent with its low risk tolerance for settlement finality. This reassurance is provided by legal opinions which conclude that a successful challenge against the settlement finality of the CHAPS system would be highly unlikely.

Principle 9 - Money Settlements

An FMI should conduct its money settlements in central bank money where practical and available. If central bank money is not used, an FMI should minimise and strictly control the credit and liquidity risk arising from the use of commercial bank money.

Scope and applicability: This principle is applicable to CHAPS and RTGS. However:

- *Key considerations 9.2 and 9.3 are not applicable and have not been assessed. They relate to where commercial bank money rather than central bank money is used for settlement.*
- *Key consideration 9.5 is not applicable and has not been assessed. It relates to an FMI conducting money settlement on its own books, where money settlement is conducted in commercial bank money.*

Rating: Observed

Summary of compliance: All settlement, including CHAPS, across accounts in RTGS is in central bank money.

Key consideration 9.1: An FMI should conduct its money settlements in central bank money, where practical and available, to avoid credit and liquidity risks.

All settlement, including CHAPS, across accounts in RTGS is in central bank money.

Key consideration 9.4: If a payment system conducts money settlements on its own books, it should minimise and strictly control its credit and liquidity risks.

All settlement across RTGS is in central bank money, which is part of the Bank's balance sheet. However, the Bank, as operator of the RTGS and CHAPS services, is not typically a counterparty to settlement. The primary exceptions are where the Bank is itself a settlement participant in CHAPS, CREST, Bacs and Cheque & Credit clearing as part of its own banking business. The Bank is also the counterparty for settlement in relation to the Notes Circulation Scheme and where it extends intraday liquidity. Separate arrangements for controlling credit and liquidity risks are in place, managed outside RTGS by the relevant business areas of the Bank.

The self-assessments against *Principle 4 – Credit risk* and *Principle 7 – Liquidity risk* explain how the Bank minimises and controls any credit and liquidity risks arising from the operation of the RTGS service.

Principle 13-Participant default rules and procedures

An FMI should have effective and clearly defined rules and procedures to manage a participant default. These rules and procedures should be designed to ensure that the FMI can take timely action to contain losses and liquidity pressures and continue to meet its obligations.

Scope and applicability: Under the CPMI-IOSCO guidance note on application of the PFMI to central bank FMIs, the PFMI is not intended to constrain central bank policies on maintaining financial stability including managing participant defaults.

This self-assessment covers the default rules and procedures that relate directly to the Bank's operation of RTGS and CHAPS. The Bank interacts with RTGS account holders, including CHAPS Direct Participants (DPs), in a range of other capacities. Most notably in this context as: prudential supervisor for some of the payment system operators; prudential supervisor for account holders such as banks, building societies and PRA-designated investment firms; and resolution authority.

In the case of a default, the outlined procedures for the RTGS and CHAPS services may be amended or driven by the Bank's actions and priorities in the capacities outlined above.

The participant default procedures for RTGS and CHAPS services are distinct but related, reflecting the historically separate ownership and governance of the infrastructure and the CHAPS system, prior to responsibility for the CHAPS system transferring to the Bank in November 2017.

Rating: Observed

Summary of compliance: Actions the Bank can take if an RTGS account holder, including a CHAPS DP, default are set out in the RTGS Terms & Conditions (and associated CREST document) and the CHAPS Reference Manual. These are supported by internal procedures.

In the event that a default event does occur, there should be no material adverse effect on the Bank's ability to meet its obligations as operator of the RTGS and/or CHAPS services. Settlement does not complete in RTGS (including for CHAPS payments) unless there are sufficient funds. The likelihood and magnitude of any credit losses to the Bank are minimised (see *Principle 4 – Credit*).

The Bank regularly practices how it would handle the default of an RTGS account holder, including a CHAPS DP. Testing is undertaken at least annually to ensure processes and

responsibilities are clear and understood internal and external under a range of specific scenarios.

Key consideration 13.1: An FMI should have default rules and procedures that enable the FMI to continue to meet its obligations in the event of a participant default and that address the replenishment of resources following a default.

Identifying a default event

Events of default are defined in Section 8 of the RTGS Terms and Conditions, including 'technical' defaults – such as where the aggregate credit balance across a firm's RTGS accounts falls below the minimum balance - and 'external' default events – such as if the Bank determines that a change in the corporate structure following a 'designated event' materially weakens the creditworthiness of an account holder. The CHAPS Reference Manual also sets out events of default in Rules 3.6 and 3.7.

In the event that a default event does occur however, there should be no material adverse effect on the Bank's ability to meet its obligations as operator of the RTGS and CHAPS services. Funds must be available before settlement can take place in RTGS, including for CHAPS payments.

Retail systems settling in RTGS

For retail systems that settle across accounts in RTGS, credit risk between the directly-settling participants can build up between when the payment is cleared, and when it is due to settle. If the default event were to affect a participant with an unsettled net debit position, losses would crystallise, particularly for settlement participants in a net credit position. In the event that a directly-settling participant of one of these systems defaults, the Bank's own resources are not used to complete settlement.

However, the Bank provides a role in assisting with managing settlements due in the event of a participant default, as a part of certain retail schemes' participant default arrangements. In particular:

- For the Bacs, Faster Payments and Image Clearing Scheme, settlement participants each provide prefunding which is held in segregated accounts in RTGS. In the event of a participant default for these prefunded retail systems, the Bank would use funds from these segregated accounts to enable settlement to complete.

- Cheque & Credit participants in the paper clearing scheme hold securities at the Bank through an arrangement where the Bank acts as security trustee for a pool of assets. The assets can be sold to refund liquidity provided on the day by 'surviving' members to enable settlement to complete in the event of member default.

Default notification

An account holder must notify the Bank when an Event of Default occurs.

The Bank is also the prudential supervisor of almost all account holders. Internal guidance and processes facilitate the sharing of supervisory judgments and information with other areas of the Bank as necessary. The FCA is the competent authority in the UK for authorising e-money institutions and payment institutions (collectively non-bank payment service providers, or non-bank PSPs). Where a non-bank PSP has a settlement account in RTGS, the FCA would share relevant information with the Bank including any decision to revoke authorisation.

Default response

Actions the Bank can take if an account holder defaults are set out in the RTGS Terms & Conditions (and associated CHAPS and CREST documentation), supported by internal procedures.

On notification the account may be suspended and credit- and debit-disabled. The Bank has wide discretion to prevent further settlement activity occurring in the event of a default of an account holder who also settles in any of the payment systems. The Bank can also suspend, or exclude, CHAPS DPs from the CHAPS system. In taking any such discretionary decision, the Bank will carefully consider its responsibilities in the widest sense i.e. as responsible for maintaining financial stability, and as a systemic risk manager for the CHAPS system.

If a CHAPS DP is suspended or excluded then no payment instructions can be accepted. The point of irrevocability and finality for CHAPS settlement instructions is clearly defined. CHAPS settlement instructions can be cancelled up to this point by the sending DP. There is no distinction made within RTGS between proprietary transactions and transactions made on behalf of a participant's customer. Prioritisation decisions are for the DP to manage, subject to the Payment Services Regulations.

Decisions made in respect of account holders, including DPs, will not be made in isolation given the Bank's wider responsibility to maintain financial stability. This includes the Bank's

responsibilities for prudential supervision and resolution. Certain decisions will be taken at Governor-level (or will follow from a Governor-level decision).

For account holders other than deposit-takers, the Bank, as operator of RTGS and CHAPS would engage, and coordinate its actions with:

- The Bank's FMI Directorate in respect of FMIs such as CLS and LCH.
- The FCA in respect of non-bank PSPs.

Key consideration 13.2: An FMI should be well prepared to implement its default rules and procedures, including any appropriate discretionary procedures provided for in its rules.

The Bank's internal procedures codify and sequence the steps the Bank would take in response to a default event. The procedures include the actions that the Bank, as operator of RTGS and CHAPS, can take in the event of a participant default and in its discretion. The internal procedures have been integrated for RTGS and CHAPS and tested since responsibility for CHAPS transferred to the Bank in November 2017.

The Bank regularly practices how it would handle the default of an RTGS account holder. Staff with appropriate system permissions can disable an RTGS account almost immediately if an authenticated instruction is received to do so. This is rehearsed regularly during testing.

The roles and responsibilities involved in these processes are outlined in comprehensive process instructions and operational procedures, which are in turn referenced in a playbook to support fast navigation in conditions of market or operational stress.

The Bank's incident management processes include roles and responsibilities for local management in the event of a critical incident, including a default situation of a CHAPS DP. The local management responsibilities in a response to an incident in relation to both the CHAPS and RTGS systems are well defined and the escalation route within the Bank established. This extends through the Deputy Governor for Markets and Banking (DGM&B), the senior Bank executive with responsibility for CHAPS and RTGS under the Bank's application of the Senior Manager's Regime.

Indeed, it is likely that a financial default event will be immediately escalated up to DGM&B due to the potential financial stability implications and cross-Bank impact.

The documents also set out the circumstances around which the Bank's Critical Incident Management Framework (CIMF) will be triggered and the extent to which the incident is

escalated within the Bank. The roles and responsibilities, including decision-making responsibility, depending on the level of invocation, are set out in the CIMF.

External stakeholders

The Bank will communicate directly with CHAPS DPs and other external stakeholders in the event of a CHAPS default event, as operator of the CHAPS.

External communications concerning any default in respect of obligations for one of the other payment systems (CREST, deferred net settlement) - beyond direct engagement with the defaulting account holder and the relevant regulators - are the responsibility of the relevant payment system operator, with whom the Bank would communicate.

Key consideration 13.3: An FMI should publicly disclose key aspects of its default rules and procedures.

The publicly available RTGS Terms & Conditions and CHAPS Reference Manual disclose key aspects of the Bank's default rules:

- Section 8 of the RTGS Terms & Conditions describes the events that could be a default, in order to provide certainty and predictability. Section 9 also sets out what action the Bank may take in such an event, including declining to process any more transfer instructions on behalf of the defaulting account holder.
- Rules 3.6, 3.7, 4.2 and 6.8 in the CHAPS Reference Manual sets out the default arrangements in relation to the CHAPS system. Additional technical information may be shared with DPs. In addition, the Bank maintains discretion over default rules and procedures in light of its broader functions and responsibilities.

Key consideration 13.4: An FMI should involve its participants and other stakeholders in the testing and review of the FMI's default procedures, including any close-out procedures. Such testing and review should be conducted at least annually or following material changes to the rules and procedures to ensure that they are practical and effective.

The Bank undertakes testing with its account holders and relevant payment system operators of its operational default procedures for an account holder in RTGS (including EUI in respect of CREST settlement banks). The operational process to suspend and then remove an account holder is documented in the RTGS process instructions and is straightforward and regularly tested.

The Bank also works with the other payment system operators, as requested, to support regular tests of the default procedures of the retail systems.

Principle 15-General business risk

An FMI should identify, monitor, and manage its general business risk and hold sufficient liquid net assets funded by equity to cover potential general business losses so that it can continue operations and services as a going concern if those losses materialise. Further, liquid net assets should at all times be sufficient to ensure a recovery or orderly wind-down of critical operations and services.

Applicability: This principle is applicable to RTGS and CHAPS jointly. Key Considerations 15.2, 15.3, and 15.4 (ring-fenced liquid net assets to cover business risk and support a recovery or wind-down plan) do not apply, and have not been assessed, given a central bank's inherent financial soundness. Key Consideration 15.5 (a plan to raise additional equity) does not apply, and has not been assessed given the Bank's ownership arrangements.

Rating: Observed

Summary of compliance: The Bank carefully monitors, manages and recovers operating and investment costs associated with the RTGS and CHAPS services.

Key Consideration 15.1: An FMI should have robust management and control systems to identify, monitor, and manage general business risks, including losses from poor execution of business strategy, negative cash flows, or unexpected and excessively large operating expenses.

The Bank of England has an enterprise-wide risk framework for monitoring and managing risks to the Bank. General business risk associated with the management and operation of the RTGS and CHAPS services is managed within this framework. Major investment projects are subject to oversight from the Bank's Investment Board. Where necessary, the Court, the Bank's board of directors, is responsible for setting and monitoring the Bank's strategy and makes key decisions on spending. The financial position, income and costs of the RTGS and CHAPS services are monitored by the Bank's finance function, in particular through the annual tariff review process.

Cost recovery and tariff setting

The Bank operates RTGS and CHAPS services with a public objective to recover its costs fully over the medium-term. The cost recovery approach aims to recover costs without generating any long-term profit or loss; to smooth costs where appropriate to reduce tariff volatility; and so there is no cross-subsidisation of one service by another.

Costs are recovered from account holders who use the RTGS service for settlement, including additional costs from CHAPS Direct Participants to cover CHAPS scheme activities. The relevant tariffs are reviewed annually, to align with expected costs, and set in advance for the coming year, applying from 1 April each year.

As the Bank uses a forward-looking measure of revenues and costs in its tariff calculations, it may in practice over- or under-recover against actual costs. The short-term implications of any over- or under-recovery are managed within the Bank's overall balance sheet. Nevertheless, the Bank aims to hold a small surplus of income in respect of each payment system (i.e. including CHAPS) to cover such fluctuations as well as any other unexpected changes in operating costs.

Tariffs are set annually to align expected income with budgeted costs, aligned with the above cost recovery approach. The annual review involves constructing robust projections on payment volumes settling over RTGS and operating costs and making an informed decision on whether the tariffs should be amended. Tariffs are agreed annually by the RTGS/CHAPS Board.

The RTGS settlement tariffs (for CHAPS and CREST DvP settlement), and the CHAPS scheme tariff each consist of an annual fee and a per-item fee. To set the 'per item' tariffs, the Bank estimates CHAPS and CREST DvP volumes in the following years. The Bank offers CHAPS Direct Participants and CREST settlement banks, through EUI, sight of relevant operating costs and investment plans as part of the annual review process.

The Bank also charges an annual fee to the settlement participants of UK retail payment systems that settle in RTGS: Bacs, the paper cheque and Image Clearing schemes, Faster Payments, LINK, and Visa. The fee reflects the marginal costs of providing the service and an element of share costs. There is no per-item fee applied.

Investment

When considering new functionality or investment project, the Bank identifies likely costs and how it will recover such costs. Account holders, in some cases through EUI and the retail operators, are consulted where any substantive investment plans would affect them and they would be expected to cover the Bank's costs. For example, payment system operators and account holders were informed of the expected costs to them arising from the spring 2017 RTGS hardware upgrade.

The Bank intends to continue operating the RTGS and CHAPS services on a full cost recovery basis via the annual tariffs. The Bank does not intend to begin recovering costs of the RTGS Renewal Programme⁴² in advance of delivery of the first tranche of functionality. This approach should ensure that the renewal is funded from future users, who stand to benefit from some of the new features, as well as current users. Recent capital investments in RTGS, such as the introductions of the Liquidity Saving Mechanism (LSM) and the Market Infrastructure Resiliency Service (MIRS) contingency, were amortised over a three to five-year period. The scale of the RTGS Renewal Programme means that the amortisation period is likely to be somewhat longer. The Bank will provide more detail on delivery costs and implications for steady-state operating costs for the renewed service in due course alongside the final delivery roadmap.

Financial risks

If in-year income from the tariffs is not sufficient to cover the annual operating cost of the RTGS and CHAPS services, the Bank has sufficient capital and reserves to absorb an under-recovery in the short-term with no material adverse effect on the Bank's financial position or its ability to deliver these services. For example, the annual operating costs of the combined RTGS and CHAPS services are around £20mn, compared with the Bank's capital and reserves of £4.5bn (end-February 2018)⁴³.

Long-term deficits are considered a very low risk due to the Bank's policy of cost recovery and the annual tariff update process in which income against operating costs is reviewed. This process includes reviewing project-specific recovery. The majority of income is generated from account holders settling in CHAPS and CREST. The Bank monitors the risk of these systems ceasing to use RTGS, or of payment volume migrating quickly to a net or commercially-settled system, leaving the Bank with unrecovered costs. The Bank judges the risk of a sudden, unexpected and permanent change causing an unrecoverable risk to the Bank's balance sheet to be extremely low.

⁴² Details of the Renewal Programme, including the new features and key milestones are contained in section II.18-II.20.

⁴³ On 21 June the Bank and HMT agreed a new financial framework for the Bank, encompassing the Bank's capital and the funding arrangements for the Bank's costs that are not directly recovered (as RTGS/CHAPS costs are). The exchange of letters setting this out between the Governor and the Chancellor of the Exchequer are published at <https://www.bankofengland.co.uk/letter/2018/banks-financial-framework-june-2018>.

Principle 16-Custody and Investment risks

An FMI should safeguard its own and its participants' assets and minimise the risk of loss on and delay in access to these assets. An FMI's investments should be in instruments with minimal credit, market, and liquidity risks.

Scope and applicability: Under the CPMI-IOSCO guidance note on application of the PFMI to central bank FMIs, the PFMI is not intended to constrain central bank policies on its investment strategy (including that for reserve management) or the disclosure of that strategy.

For the purposes of this assessment, the relevant assets are balances held in RTGS as well as euro cash and securities provided to the Bank in order to generate intraday liquidity. All relevant collateral is transferred to the Bank by way of full title transfer – the Bank does not hold assets in custody in connection with its operation of RTGS.

Key Consideration 16.4 (investment strategy) does not apply, and has not been assessed; no assets relating to the RTGS Service are invested other than as part of the Bank's overall approach to managing its balance sheet.

No assets are taken in relation to the Bank's operation of CHAPS. This principle is therefore not applicable to the Bank in relation to CHAPS.

Rating: Observed (RTGS); Not applicable (CHAPS)

Summary of compliance: The Bank adopts a risk-averse approach in relation to securities used to generate intraday liquidity for account holders.

Key consideration 16.1: An FMI should hold its own and its participants' assets at supervised and regulated entities that have robust accounting practices, safekeeping procedures, and internal controls that fully protect these assets.

Accounts in RTGS hold sterling cash balances, including intraday liquidity secured against collateral. The Bank uses a risk-based hierarchy when deciding where to hold collateral (i.e. cash and/or securities) provided by account holders, whilst taking into account the ease of dealing with the custodians in question and any regulations or restrictions that would apply when using the services of that entity. In descending order of preference the Bank's preferred means of holding collateral are through:

- a) direct Bank membership of a Central Securities Depository (CSD) or ICSD (International CSD) for securities issued directly into the CSD/ICSD;

- b) the relevant central bank acting as custodian (including the Eurosystem's Correspondent Central Banking Model); and then
- c) direct links (i.e. with no intermediary custodian) between an investor CSD and the relevant issuer CSD.

The selection is also subject to cost and operational efficiency, for example, it is not proportionate for the Bank to be a direct member of every CSD and ICSD which can both hold the relevant collateral and meet the Bank's criteria.

The three commercial CSDs of which the Bank is a member (i.e. CREST – the UK CSD – along with Euroclear Bank and Clearstream, the two ICSDs) are subject to prudential supervision. The Bank also reviews the ISAE 3402 audits for these institutions.

The Bank, as operator of RTGS, also undertakes a risk assessment of the small number of direct links between the ICSDs and other domestic CSDs which focuses on legal soundness, custody risk, risk management procedures and operational reliability. These assessments are reviewed and signed off at Executive Director level.

Internal controls and processes are in place to reduce the risk of fraud that could adversely affect account holders. The Bank maintains strict segregation between its own accounts and those of third parties.

Key consideration 16.2: An FMI should have prompt access to its assets and the assets provided by participants, when required.

RTGS has no assets itself – it is the accounting system which holds the commercial participants' funds at the Bank. The Bank takes full legal ownership of all collateral that is placed with it under the terms and conditions of the Sterling Monetary Framework. The Bank's assets are strictly segregated from those of third parties, and between those assets held as collateral and those held as reserves or other funds.

During RTGS operating hours the Bank provides immediate access to funds held in RTGS, and the ability to settle in real-time. The securities the Bank holds against the provision of intraday liquidity can be accessed on demand if the Bank considers that the collateral is not required to cover any exposure.

For the Bacs, Faster Payments and Image Clearing schemes, the Bank holds cash on behalf of directly settling participants in prefunding accounts that the account holders have control

over (and access to) these funds subject to a minimum balance set by the individual scheme operators to match the net sender cap in the relevant payment system.

The Bank has procedures for identifying, verifying and responding to potential or actual trigger events and events of default under the legal agreements in place between the Bank and account holders for collateral. These agreements outline the steps required for:

- issuing a default notice under one or more of the legal agreements;
- establishing gross and net exposures to the defaulting account holder;
- valuing collateral under the relevant legal agreements; and
- closing out/setting off exposures between the Bank and the account holder.

Key consideration 16.3: An FMI should evaluate and understand its exposures to its custodian banks, taking into account the full scope of its relationships with each.

Due to the Bank's hierarchy of preferences described above, the Bank's use of commercial custodians is low, and risk of actual loss is very low. The Bank is not exposed to any significant credit risk. Any cash balances held externally at a commercial custodian are either defunded overnight, or designed to be sufficiently low to be within the Bank's risk tolerance. Exposures to commercial custodians are monitored by the Bank's dedicated second line financial risk division as part of a 'three lines of defence' framework.

Principle 17-Operational risk

An FMI should identify the plausible sources of operational risk, both internal and external, and mitigate their impact through the use of appropriate systems, policies, procedures, and controls. Systems should be designed to ensure a high degree of security and operational reliability and should have adequate, scalable capacity. Business continuity management should aim for timely recovery of operations and fulfilment of the FMI's obligations, including in the event of a wide-scale or major disruption.

Scope and applicability: Sources of operational risk could arise from either the operation of the RTGS or CHAPS services. One of the primary sources of potential operational risk to the CHAPS system is that RTGS infrastructure which provides settlement of CHAPS payments. As an end-to-end systemic risk manager, we broadly define the CHAPS system to including the Bank's suppliers, direct and indirect participants (and their suppliers) and end-users. The operational risk implications are both considered as part of the broader integrated risk management framework.

Rating: Observed

Summary of compliance: The RTGS/CHAPS risk management framework details the system of risk management for the Bank's delivery of RTGS and CHAPS, which ensures that relevant risks are identified, assessed, monitored, controlled and mitigated appropriately to provide a high degree of security, reliability and availability. The new integrated RTGS and CHAPS risk management framework covers the operational risk arising from the Bank's delivery of RTGS and CHAPS. A set of Key Risk Indicators is used to provide both qualitative and quantitative thresholds at which risk exceeds tolerance.

The Bank clearly defines operational reliability objectives for RTGS and CHAPS. The Bank-wide risk tolerance defines the nature and extent of risks (including operation risk) that the Bank is willing to tolerate. The RTGS/CHAPS risk tolerance statements are consistent in scope, but given the criticality of the RTGS and CHAPS services, apply tighter tolerances in some areas. The Bank has a very low but non-zero tolerance for operational unavailability, and considers the trade-off between integrity and availability.

The Bank has comprehensive arrangements for business continuity and crisis management. The Bank operates the RTGS service with no single point of failure. The tertiary option in the event of both primary sites being unavailable is to invoke MIRS.

Since responsibility for CHAPS transferred to the Bank, the combined RTGS and CHAPS operations have been subject to Bank-wide business continuity planning. Most CHAPS Direct Participant and RTGS incidents are managed at a local level, but those of a more significant nature have the potential to invoke the Bank-wide Critical Incident Management Framework (CIMF).

Key consideration 17.1: An FMI should establish a robust operational risk-management framework with appropriate systems, policies, procedures, and controls to identify, monitor, and manage operational risks.

Operational risk management framework for RTGS/CHAPS

The Bank has a robust enterprise-wide operational risk management framework with appropriate systems, policies, procedures and controls in place to identify, monitor and manage operational risks. It sets out a Bank-wide minimum standard for the management of risks, including operational risks. Risks are identified and logged, and the probability of their crystallisation and impact are assessed. The controls and mitigation for these risks are also logged and tracked.

Within the context of the Bank's risk management framework, an RTGS/CHAPS-specific risk management framework has been created which follows the structure of the Bank-wide framework and highlights all appropriate systems, policies and controls in place to identify, monitor and manage risks that may impact the operation of the RTGS and CHAPS services.

The RTGS/CHAPS Board has an overall responsibility for approving and maintaining the RTGS risk framework and setting risk tolerance levels for RTGS and CHAPS. The RTGS/CHAPS Board Risk Committee has delegated responsibility for monitoring that risks associated with the operation of the RTGS and CHAPS services are identified, evaluated and appropriately mitigated. It reviews conformance with business continuity and crisis management plans, including the results of relevant exercises that test the plans.

Identifying operational risk

The KRIs for the RTGS and CHAPS services are in place to cover process, security, people and business continuity risks.

Aside from external cyber risks, the Bank also has policies to mitigate against insider risks as part of its cyber security framework. This draws on a regular assessment of threats to RTGS. The Bank seeks to ensure that key person risks are identified and mitigated.

Monitoring and managing operational risk

The roles and responsibilities of day-to-day operational risk management are delegated to the executive from the Board through the Deputy Governor for Markets & Banking. This is recorded in both governance documentation which covers responsibilities and routes of escalation and, for those staff that have specific objectives to identify and manage operational risks within their areas of responsibility, the Bank's performance review system. Further details on the potential categories and sources of operational risk are provided below.

The monitoring of operational risk is managed through the combined RTGS/CHAPS Risk Management Framework. As described in *Principle 3 – Comprehensive framework for the management of risk*, the operational risks arising from and to RTGS, CHAPS and the wider Bank are tracked on the RTGS/CHAPS risk report. As an end-to-end systemic risk manager, this includes systemic risks arising from and to the CHAPS ecosystem.

The risk report and underlying integrated risk register, emerging risk register and key risk indicators form the tools that the executive and Board Risk Committee use to monitor and review operational risks to RTGS/CHAPS. The tools themselves have been reviewed and agreed by RTGS/CHAPS Board.

For CHAPS DPs, the CHAPS Reference Manual and supporting documents set out the necessary operational and technical requirements. Adherence to the CHAPS Reference Manual is monitored by an annual self-certification and review process incorporating industry-standard controls, e.g. ISO 27001.

Policies, processes and controls

The Bank has appropriate Bank-wide policies in place to attract, train and retain individuals with the experience required, and monitors key person risk on an ongoing basis. The Bank's Chief Information Security Officer is responsible for developing and contributing to policies regarding information security that covers RTGS and Bank-wide IT systems.

Operational controls for the RTGS and CHAPS services, such as daily checklists and process instructions, are documented and reviewed by local management. The annual, externally-commissioned ISAE 3402 control audit for RTGS looks at whether the Bank meets the Internal Control Policy as specified. This is in addition to any reviews undertaken by internal audit and compliance.

The Bank enforces segregation of duties and/or dual control over certain key processes to prevent fraud. For example, the operational team that manages the RTGS service on a day-

to-day basis cannot transfer money within RTGS. This is undertaken by a separate division within the same directorate.

Change management policies

Risk management is a key element of all change evaluation, both at the design phase and throughout the delivery and evaluation phases.

A formal and proportionate sign-off process for changes is in place. The level of governance and sign-off required is dependent on the assessed potential impact of the change on RTGS and CHAPS. Assurance and risk mitigation plans form part of the approvals process. In later phases of the change management process, monitoring remains proportional to the size of the change.

A local system tracks all changes to RTGS currently in the pipeline; changes are allocated to a maintenance release or project based on their nature and priority. This process must be completed before the technological change procedure outlined above takes place. If deemed necessary, an appropriate level of technical testing and user acceptance testing will take place, which involves processing messages through the system in order to ensure the software is functional and will often include external involvement (particularly in the case of larger project implementations), including participation from relevant account holders and payment system operators.

For change management decisions involving investment decisions and wider projects, the Bank's Technology directorate has a robust centralised change management process. Investment for projects is determined at the Bank-wide Investment Board.

As of June 2018, the RTGS Renewal Programme had a parallel set of executive governance arrangements, similarly reporting in to RTGS/CHAPS Board. The senior executive body was the RTGS Renewal Programme Board. The various work streams of the Programme fed into decisions made at Programme Board, which reported to RTGS/CHAPS Board.⁴⁴

Key consideration 17.2: An FMI's board of directors should clearly define the roles and responsibilities for addressing operational risk and should endorse the FMI's operational risk-management framework. Systems, operational policies, procedures,

⁴⁴ Subsequent to the point of assessment, the Court of the Bank agreed changes to the governance of the RTGS Renewal Programme at their 21 September 2018 meeting. The new RTGS Renewal Committee is a sub-committee of Court responsible for overseeing delivery of the RTGS renewal programme, and for making key decisions on the overall scope of the programme, the procurement and spending, within the overall budget envelope agreed by Court. It has six members, two external members from each of Court and the RTGS/CHAPS Board, as well the Deputy Governor for Markets & Banking and the Bank's Chief Operating Officer.

and controls should be reviewed, audited, and tested periodically and after significant changes.

Roles, responsibilities and framework

The governance arrangements for RTGS and CHAPS in relation to identifying, assessing, remediating and reporting risks (including operational risk) are set out in a combined RTGS/CHAPS risk management framework. The governance arrangements that define the roles and responsibilities for maintaining a risk management framework (including for operational risk) are set out in more detail under the self-assessments against *Principle 2 – Governance* and *Principle 3 – Framework for the comprehensive management of risks*.

The responsibility for approving the RTGS/CHAPS risk management framework is reserved for RTGS/CHAPS Board. Operational risk is a key element of the combined risk management framework. Board Risk Committee is responsible for monitoring the operation of the RTGS/CHAPS risk management framework and assurance on its quality and performance. It also ensures that, where relevant, it will operate in an aligned manner with the Bank-wide risk management framework.

The responsibility for managing risks on a day-to-day level is delegated to the executive from the RTGS/CHAPS Board through the Deputy Governor for Markets and Banking. On a day-to-day basis responsibility for managing risk resides with the head of the area responsible for operating RTGS and CHAPS, advised by various advisory executive forums.

Whilst RTGS/CHAPS Board is responsible for the delivery of the RTGS and CHAPS systems, the Board operates within the Bank-wide framework for the management of risks to the Bank's own assets. Critical assets relevant to RTGS and CHAPS include the Bank's staff, the RTGS infrastructure and a range of supporting technology. The Board cannot operate independently of the wider Bank. In particular this is true for how risks are managed and mitigated.

Additional features have been added to the framework for CHAPS where a small number of 'scheme'/end-to-end risks benefit from richer treatment than would be possible under the standard taxonomy used for the Bank-wide risk framework.

Review, audit and testing

The Bank, as RTGS operator, reviews, audits, and/or tests procedures and controls periodically and after significant changes to minimise operational risks. Under the three lines of defence model, the Bank's internal audit function carries out an independent annual risk

assessment of policies, procedures and controls to determine the focus of auditing carried out in relation to both RTGS and CHAPS.

In addition to the Bank's Internal Audit function, the Bank annually commissions an external control audit on the operation of defined controls related to the Bank's RTGS service. A report is produced to provide assurance to Bank's management and governance, and key stakeholders who use the RTGS service, on the operation of the Bank's control environment and procedures as they relate to the RTGS service.

The Bank undertakes periodic testing of some aspects of its operational risk management arrangements with account holders and payment system operators.

An annual Participant Assurance exercise is conducted with all CHAPS DPs, with evidence submitted subject to DPs' internal audit sign-off.

Key consideration 17.3: An FMI should have clearly defined operational reliability objectives and should have policies in place that are designed to achieve those objectives.

The Bank's mission is to promote the good of the people of the UK by maintaining monetary and financial stability. Given the importance of CHAPS to financial stability, the Bank targets availability of CHAPS settlement to be at least an average of 99.95% over any month.

In the case of an outage, however, the Bank's primary goal is to maintain data integrity. The Bank seeks to deliver this through either restoration of the live RTGS service, invoking standby arrangements in an orderly manner, or activating MIRS, the additional contingency infrastructure that can be used in the event of an RTGS failure.

Should the RTGS system become unavailable, the Bank has a near-zero tolerance for restarting settlement without ensuring that to do so would be safe. This requires ensuring that opening balances are correct (to ensure that all payments settled once the system has restarted are valid) and being reasonably certain that restarting would not cause a reoccurrence of the fault or error. The Bank also has a near-zero tolerance for payments settling any later than the day which CHAPS Direct Participants intended for their payments to settle.

For certain time critical processes, there is also a near-zero tolerance policy for delays to settlement in RTGS. For example, there are contingency arrangements in place for CLS pay-ins to ensure that they can settle within the CLS contingency window even in the event of an RTGS outage. The Bank also commits on a best endeavours basis to processing two

CHAPS payments per participant per hour to ensure that the most critical payments can still be made.

CHAPS DP operational availability is monitored throughout the CHAPS day, with action taken where breaches of agreed rates are indicated.

Other performance measures regarding DP availability are monitored on a monthly basis. Any breach outside tolerance is identified, root cause analyses undertaken and rectification/mitigation plans put in place and monitored. Where relevant, consequence management is progressed with DPs. DP performance is also tracked on a rolling quarter by quarter perspective in order to measure trends and emerging potential systemic risks.

Policies are in place to achieve these stated operational reliability objectives. This include: the comprehensive and regularly reviewed and tested incident and crisis documentation; our continued intent to have a tertiary solution, and principles that relate to the invocation of MIRS.

The Bank also has an option of extending the CHAPS settlement to 20:00, enabling participants to resolve issues and finalise settlement of their most critical payments. Similar arrangements apply for CREST settlement.

Key consideration 17.4: An FMI should ensure that it has scalable capacity adequate to handle increasing stress volumes and to achieve its service-level objectives.

Volume testing takes place regularly to ensure that the RTGS system is able to consistently handle peak volume settlement. This includes testing the ability to process a full day's payments - in the event of an outage for part of the day – within a shorter window. Regular volume testing is based on the transactions received on a record day plus an additional 10% buffer, all for processing within three hours. Volume testing is also undertaken using MIRS.

The operational capacity of SWIFT is monitored through a regular monthly report of performance against SLA on FIN-Copy service. An annual incident review meeting is held as part of our relationship with SWIFT.

The RTGS hardware and associated software has the capacity to process more than 300,000 transactions in three hours. If volumes were to increase greatly, the Bank would review how to increase capacity further.

In order to estimate future capacity demands, the Bank produces a series of volume forecasts. These are also shared with CHAPS Direct Participants to support their capacity planning. Forecasting for peak days is performed monthly 12 months in advance, and

forecasts acted upon if exceptional business peaks are identified. Total yearly volumes for the next ten years are forecast annually.

Key consideration 17.5: An FMI should have comprehensive physical and information security policies that address all potential vulnerabilities and threats.

The Bank has a clear Information Security Management System (ISMS), appropriately restricted physical and logical access, an appropriate degree of staff security vetting before being allowed unescorted access within the Bank, or access to Bank systems, and local representatives to advise on data protection and Freedom of Information as well as central teams.

The Bank's information security policies are produced to apply across all platforms i.e. the policies are not specific to RTGS. The Bank's internally produced policies are complemented by a variety of international and domestic standards.

Physical security

Physical access to the Bank's premises, systems, other equipment and documentation is restricted to authorised individuals. The Bank's guidelines on the information technology elements of physical security also cover the disposal of hardware and sensitive paper-based information.

Physical security of the Bank is the responsibility of the Bank's Security and Privacy Division (SPD). SPD are responsible for security for the whole Bank and work closely with law enforcement and governmental organisations to co-ordinate physical threat intelligence. The Bank aims to have the highest industry-level standards of physical security and to operate robust incident management processes to protect its people and physical assets from external or internal threats. Its tolerance for compromise of physical security is very low.

Employees and contractors are subject to the UK Government's security vetting process before being allowed unescorted access within the Bank. Once access is granted, further controls are in place over physical security including security passes and monitoring of access.

The Bank's requirements, as the systemic risk manager for CHAPS, for the endpoints of DPs are set out in the CHAPS Reference Manual. Direct Participants self-assess against these requirements and provide an annual attestation to the Bank. The Bank conducts selective risk-based verification to ensure compliance with the CHAPS Reference Manual.

Information security

The Bank-wide information security objectives include use of the Bank's sector knowledge to secure the Bank, and using Bank expertise to help defend the sector. For RTGS and our external suppliers, this primarily means drawing on the advice of the Bank's information security experts through a combination of first and second line functions.

Within the wider Bank, the Bank's Chief Information Security Officer is responsible for managing information security policies, governance and risk, user education and conducting investigations. The Bank works closely with the National Cyber Security Centre and gathers intelligence from other external sources. The Bank's internally produced policies are complemented by a variety of international and domestic standards.

The Bank's critical information assets are protected by detecting and mitigating cyber threats, through robust governance of risk and compliance and management of information security policies, threat and risk assessments, appropriate access controls for staff, and by providing all Bank staff with the knowledge they need to meet their information security responsibilities. This includes cultural awareness programmes such as regular phishing campaigns against staff.

The Bank's risk tolerance for information security of critical assets is very low. RTGS, SWIFT and all external services are protected by firewalls. The RTGS infrastructure is hosted on a segregated network that is separated from the rest of the Bank's IT estate by 'boundary' firewalls with only permitted connections allowed. The Bank network is rigorously monitored to detect intrusion, with reports reviewed by security staff.

RTGS settlement instructions are protected from interception and messages are encrypted and authenticated in order to establish validity and non-repudiation.

Processes and technology are subject to external assurance such as penetration testing and the ISAE3402 control audit. In 2017 RTGS achieved an ISO 27001 certification, an internationally recognised standard for information system security management. Information security is also audited on a Bank-wide basis as well as at a business area level specific to RTGS.

Key consideration 17.6: An FMI should have a business continuity plan that addresses events posing a significant risk of disrupting operations, including events that could cause a wide-scale or major disruption. The plan should incorporate the use of a secondary site and should be designed to ensure that critical information technology (IT) systems can resume operations within two hours following disruptive events. The plan should be designed to enable the FMI to complete settlement by the

end of the day of the disruption, even in case of extreme circumstances. The FMI should regularly test these arrangements.

Objectives of business continuity plan

Each operational area of the Bank undertakes an annual review of business continuity plans to ensure the viability of contingency arrangements. The Bank's Chief Operating Officer has overall accountability for the Bank's business continuity programme. Local Executive Directors are accountable for ensuring their directorates have developed and tested plans. A central Business Continuity team exists to review local plans annually or following any major changes within the business area.

The Bank has formal business continuity arrangements for the operation of RTGS and CHAPS. Policies are designed so that the Bank can maintain full operational capabilities even in the event of major disruption or loss of one site, and achieve recovery and timely resumption of critical operations. For major incidents, the Bank can fall back to a secondary site within an hour, typically around 45 minutes.

In the event of loss of both sites, operational capabilities will be maintained by switching to a tertiary site (MIRS) operating on different software in no longer than around two and a half hours. For minor incidents, RTGS and CHAPS would continue to operate without impact because of back-up processes and redundancy built into the system.

The Bank maintains a recovery target of two hours, but cannot guarantee to achieve to it in every circumstance, for example where a serious loss of data integrity was uncovered, as integrity must be restored first. Recovery could be either restoring the primary site or switching to another site, including MIRS. Where necessary, the Bank is able to extend operation of RTGS up to 20:00 to give the Bank and the DPs time to deal with technical issues and allow transactions to take place on the day intended.

The Bank has explored extreme but plausible cyber scenarios and uses the results to feed into continuous improvements into the continuity and resilience of its system.

Most RTGS and CHAPS Direct Participant incidents are managed at a local level, but those of a more significant nature have the potential to invoke the Bank-wide Critical Incident Management Framework (CIMF), which enables communication, information management and decision making processes and senior stakeholders up to Governor-level to help manage disruptive events. The CIMF is able to draw on technical, communication and leadership resources Bank-wide in order to resume interrupted services efficiently while managing communication with key external stakeholders. This plan is tested regularly.

With regard to the Bank's role as an end-to-end systemic risk manager for the CHAPS system, as part of the participant assurance work, the Bank requires the business continuity planning for CHAPS Direct Participants to at least meet the equivalent standards as set out in the PFMI. The requirements are determined by how systemic the CHAPS Direct Participant is. The more systemic Direct Participants are required to be able to receive payments at their contingency site SWIFT Interface within one hour of the decision to invoke their contingency site measures. Less systemic Direct Participants are required to be able to receive payments at their contingency site SWIFT Interface within two hours of the decision to invoke their contingency site measures.

Data Integrity

The Bank's primary concern is data integrity – it would not resume operations for RTGS or CHAPS until it was sure it was certain of integrity of the data. There is a requirement for the reconciliation of all Direct Participants balances overnight to ensure the integrity of the data with no discrepancies at the opening of RTGS each day. The Bank has a set of principles defining the circumstances under which it would invoke MIRS; these principles have been shared with relevant external stakeholders.

In the event of a processing interruption to Bank systems, procedures are in place which allow the reconstruction of data files, programs and transactional information (including the status of transactions), followed by the restart of processing and critical business operations at fallback locations.

Secondary site and alternative arrangements

The Bank operates the RTGS service with no single point of failure under an active/hot-standby configuration. During operating hours, one of two sites is always actively processing payments (primary) whilst the other – technologically identical secondary site – is updated in real-time and stands ready to take over the processing of payments if required (standby). The fallback process should not take longer than an hour. Key operational documents are backed up on an auxiliary system.

The Bank has adopted MIRS as an additional layer of contingency to RTGS. SWIFT runs the MIRS service from outside the UK and it uses separate hardware and software. MIRS activation should take no longer than two and a half hours, depending on the complexity of reconciliation calculations; MIRS takes the most recent balances that are known with certainty and applies all of the message confirmations received since that point. Having

recourse to MIRS reduces a number of risks including those related to credit, technology, geographic concentration, operations, and complex designs.

The Bank regularly tests continuity arrangements for its secondary and tertiary sites for the provision of the RTGS service. For example, MIRS tests are performed at least four times a year, as well as regular fallbacks between the Bank's primary and secondary site.

The RTGS Reference Manual sets out detailed operating hours and intraday events. Any contingency extension to RTGS operating hours is exceptional and requires justification from the relevant account holder or payment system operator. This would typically be to complete processing after operational issues. The Bank can also call an extension.

The primary alternative arrangement in the event of a loss of both sites is the invocation of MIRS, as described above.

Both the Bank, as operator of CHAPS, and EUI make clear to the relevant RTGS account holders the rules governing an extension. As long as the extension is within the timetable agreed with payment system operators, the Bank will normally grant it. Any instructions that are not settled (either due to resource constraints or operational error) are cancelled by the Bank towards the end of the extension. Sending institutions may resubmit them the next business day. Specific contingency arrangements exist for instructions relating to CREST and deferred net settlements. There are contingency arrangements in place for CLS payments to ensure that they can settle within the CLS contingency window in the event of an RTGS outage.

In an extreme scenario, some CHAPS payments would be able to be enacted by a manual processing solution. This would require upload to a secure online facility in order to allow critical payments (identified by participant) between participants to continue.

Review and testing

RTGS/CHAPS Board defines and assesses the extent to which the Bank complies with the associated risk tolerance statements within the RTGS/CHAPS risk management framework. Responsibility for reviewing and testing the business continuity plans in relation RTGS and CHAPS is delegated to the executive. However the outcomes in relation to the defined risk tolerance statements (including business continuity planning) are reviewed by Risk Committee, and subsequently Board, as part of the risk framework.

To assess the ability of the Bank to be able to deliver on its business continuity plan, the Bank has engaged in an extensive programme of testing. This has encompassed both

testing following the creation of the integrated incident management framework and the regular schedule for testing on an ongoing basis.

Ahead of the integration of CHAPS into the Bank, the Bank and CHAPS Co amended the incident management process to co-ordinate between the two plans. Over 2018, the Bank has enhanced this joint incident management framework. The integration has produced two new joined-up incident management guides, one for managing RTGS incidents and another for managing CHAPS Direct Participant incidents. On 19 June, the Bank tested the procedures in a desktop exercise, using a cyber-attack scenario.

The Bank intends to run further similar exercises every six months with the next exercise to be conducted by the end of January 2019.

Alongside the internal testing of the Bank's incident management framework, the Bank also takes part in, or leads, industry-wide tests. In November 2016, the Bank worked with the industry to deliver a challenging scenario based on a prolonged outage to RTGS (and hence CHAPS settlement). Participants included the operators of CREST, Bacs and Faster Payments as well as many of their settlement participants and other FMIs (such as CCPs). As with other tests, a number of lessons learned were identified and further improvements to help the Bank and industry prepare for real crisis situations.

These cross-industry exercises are intended to be repeated every two or three years in the future to build on the work that has already been completed. The next exercise is in November 2018.

Alongside the large scale external tests, the Bank runs multiple tests throughout the year with a number of third parties. These include the regular testing of out of hours participant debit cap increase requests for participants in prefunded deferred net settlement schemes (Bacs, Faster Payments and Image Clearing) involving the relevant PSO and participant, and a comprehensive bilateral testing plan with other RTGS stakeholders.

Key consideration 17.7: An FMI should identify, monitor, and manage the risks that key participants, other FMIs, and service and utility providers might pose to its operations. In addition, an FMI should identify, monitor, and manage the risks its operations might pose to other FMIs.

Risks to the FMI's own operations

The area that operates the RTGS and CHAPS services maintains and updates a risk register which assesses risks that operating RTGS and CHAPS pose to the Bank. Each risk

on the risk framework is assessed for the likelihood and impact to the operation of RTGS and CHAPS. Monitoring of the risks is undertaken by the executive and is subject to review by RTGS/CHAPS Risk Committee. Where a breach is identified, decisions are made on how to manage that risk. Risk assessments take into account the impact of third parties on the delivery of the RTGS and CHAPS services.

There is regular horizon scanning of risks and monitoring against agreed Key Risk Indicators to ensure that risk levels do not exceed agreed tolerances.

For CHAPS, the Bank identifies and assesses Critical Service Providers (CSPs). These are providers where a disruption to the services provided would impact CHAPS in the short term, to the extent that disruption to the continued smooth functioning of CHAPS was likely, with potential material adverse effects on financial stability.

In order to manage the risks to CHAPS, the Bank assesses these CSPs against the expectations set out in Annex F of the PFMLs. This sets out expectations applicable to CSPs.

Two sets of services provided by third parties have been identified as critical to the continued functioning of the CHAPS service. These are the Bank Reference Data (BRD) service provided by Pay.UK via VocaLink, and the SWIFT messaging and network services.

Formal contracts, including service level agreements, are in place with third party service providers to RTGS and the Bank monitors their activities. Whilst most software pertaining to RTGS is written in-house, and therefore involves no third party risk, all of the Bank's hardware relating to the RTGS infrastructure is provided by third parties, although it is installed within the Bank's premises.

A vendor management framework aims to identify, assess and mitigate the impact posed to RTGS through the failure of relevant software or service providers.

RTGS (and hence CHAPS settlement) is reliant on the effective functioning of the SWIFT messaging service on a day-to-day basis to receive settlement instructions and communicate the outcome of settlement. The SWIFT messaging service is operationally robust with a high level of availability. In the event of a loss of SWIFT connectivity, the Bank aims to settle a small number of payments per hour manually to support the settlement of the most critical payments. Settlement of the retail payment systems that settle in RTGS and CLS pay-ins/pay-outs would be transmitted to the Bank via an alternative channel and processed manually.

For SWIFT, the Bank, as operator of RTGS and CHAPS, takes account of co-operative oversight arrangements when considering what assurance to seek directly from SWIFT. The operators of the CREST and retail systems, where relevant, manage their own relationships with SWIFT.

In extending access to non-bank PSPs in RTGS/CHAPS, and the use of technical aggregators in CHAPS, the Bank has also considered the risks that these changes could pose to RTGS and the wider system. In both instances careful consideration was given as to how to mitigate risks. For non-bank PSPs, the Bank worked with the FCA to ensure that in extending access to non-bank PSPs, the Bank's ability to achieve its monetary stability and financial stability objectives and the resilience of RTGS was maintained. For CHAPS Direct Participants using aggregators, additional tailored security requirements were put in place.

Risks posed to other FMIs

The clearing and exchange of individual payments in the retail payment systems are not dependent on RTGS. The retail payment systems are, however, dependent on RTGS for settlement of the net obligations in central bank money. Functionality to settle the retail payment systems on a deferred net basis is included in MIRS. If there are issues with transmission of the settlement figures to the Bank via SWIFT, these data can be received via other means and processed manually.

In the case of the Bacs, Faster Payments and Image Clearing schemes, net debit positions must be prefunded with cash held in RTGS. Lack of access to RTGS would therefore mean that additional cash could not be transferred to support increases to the limits of these net debit positions (unless MIRS had been invoked). It is feasible that a retail system net settlement could be delayed (either if manually input, or if RTGS and MIRS were unavailable). This would likely lead to an increase in settlement exposures for the non-prefunded schemes, which could become more of a risk to financial stability over time. In the event of an issue with SWIFT connectivity to RTGS, settlement of the retail payment systems that settle in RTGS and CLS pay-ins/pay-outs can be transmitted to the Bank via an alternative channel and processed manually. CREST can continue to operate without the RTGS connection in 'recycle' mode, with any liquidity transfers with RTGS being made manually.

In the twelve months leading up to end-June 2018, 25 new payment system settlement participants have been added across the seven systems which settle in RTGS. Five of these were for CHAPS. Demand to be a new settlement participant has come from multiple sources, including entities subject to ring-fencing rules (Structural Reform) and newly eligible

institutions, e.g. FMIs and non-bank PSPs. Extensive stakeholder management and coordination has been undertaken to ensure that the significant increase in on-boarding does not compromise the performance of RTGS at any time and that the Bank can meet demand for access where to do so does not impair the stability or resilience of RTGS.

In the event of incidents in the payment systems that settle in RTGS, the relevant payment system operators share information with the Bank where relevant. For CHAPS, this extends to the operator of Bacs and Faster Payments sharing information about incident within their systems, or their population of settlement participants, with the Bank as CHAPS operator. This is particularly valuable where a payment service provider wants to re-route payments from the retail systems through CHAPS.

Industry-wide scenario exercises are walked through periodically to help identify improvements to collective response arrangements, with a view to improving resilience of the financial sector as a whole. As at the point of assessment, the last major exercise was a November 2016 scenario based on a prolonged outage to RTGS. The exercise received positive feedback from the industry and allowed the Bank to gain an understanding of the effect on users of RTGS and their contingency processes in the event of an outage to RTGS.

Principle 18 - Access and participation requirements

An FMI should have objective, risk-based, and publicly disclosed criteria for participation which permit fair and open access.

Scope and applicability: Under the CPMI-IOSCO guidance note on application of the PFMI to central bank FMIs, the PFMI is not intended to constrain central bank policies on whom to offer central bank accounts to and on what terms. The Bank's assessment of this principle in relation to RTGS was considered in the context of which accounts can be used for settlement of payment obligations, but not access to the Bank's overnight and other central bank facilities under the SMF delivered through accounts held in RTGS. For example, central banks may have separate public policy objectives and responsibilities for monetary and liquidity policies that take precedence. The main guidance also states that "central banks may exclude certain categories of financial institutions (such as non-deposit-taking institutions) ... because of legislative constraints or broader policy objectives."

There is a separate set of criteria and requirements to become a CHAPS Direct Participant. This is covered separately in this assessment. However, it includes the requirement to hold a settlement account at the Bank that can be used for settling CHAPS.

Rating: Observed

Summary of compliance: The access criteria to hold an account in RTGS that can be used for settlement and to become a CHAPS Direct Participant are both carefully designed and regularly reviewed to ensure there are no unreasonable barriers to entry to specific institutions or group of institutions. The Bank looks to ensure that access is available as widely as possible, whilst ensuring the integrity of the systems and its role regarding maintain financial and monetary stability. The Bank publishes the access criteria for settlement accounts in RTGS and CHAPS on the Bank's website.

References to 'settlement accounts' refer to RTGS accounts that can be used for the purposes of settlement. This includes reserves accounts for institutions eligible for the Bank's Sterling Monetary Framework (which as separate eligibility criteria, outside the scope of this self-assessment) as well as settlement accounts for institutions ineligible for the SMF)

Key consideration 18.1: An FMI should allow for fair and open access to its services, including by direct and, where relevant, Indirect Participants and other FMIs, based on reasonable risk-related participation requirements.

There are two broad functions provided through accounts held in RTGS – participation in the Sterling Monetary Framework (SMF) and the use of funds to settle payment system

obligations, including CHAPS. Access criteria to the SMF are not covered in this self-assessment. The Bank can incur risks through its provision of settlement services; it mitigates these risks by choosing its counterparties carefully and by securing any exposures with appropriate collateral. The Bank provides access directly to account holders in RTGS and does not set any requirements on account holders regarding onwards provision of services.

Participation criteria and requirements

The Bank has published eligibility criteria for those wishing to become settlement account holders in RTGS (and access intraday liquidity) as well as operators of payment systems which want the Bank to act as settlement agent for their system. The Bank publishes these criteria in section 4 of the Settlement Account Policy.

The Bank's Settlement Account Policy is clear that account holders must have the operational capacity to participate, and effectively settle transactions, in the RTGS system. The policy also sets out the high-level legal and technical requirements for accessing intraday liquidity. To be eligible for a settlement account in RTGS, an institution must be: a bank or building society; a broker-dealer; a CCP or other Financial Market Infrastructure (FMI) that is ineligible for a reserves account but that provides a function that is systemically important and the Bank considers that financial stability would be enhanced if it settled in central bank money by becoming a direct member of a system for which the Bank acts as SSP; or an authorised electronic money institution or authorised payment institution.

An institution that is eligible for a reserves account but is not granted access would not be eligible for a settlement account at the Bank for the purposes of directly settling payment obligations.

CHAPS eligibility criteria

The high level eligibility criteria for CHAPS Direct Participants are that a financial institution must: hold a reserves or settlement account at the Bank; be a participant within the definition set out in the Financial Markets and Insolvency Regulations 1999; if domiciled outside England and Wales, provide information about company status and settlement finality through a legal opinion; satisfy the Bank on security and resilience arrangements through a standard attestation process; and comply with the CHAPS Reference Manual on an ongoing basis.

Payment system requirements

To hold a settlement account at the Bank, an entity must be ‘*a member of a payment system (or is in the process of applying to join a payment system) for which the Bank has chosen to act as settlement service provider*’. The payment system operators set their own access criteria for settlement participation. In the case of Bacs, the paper and Image Clearing schemes, CREST and Faster Payments, the operator requires their directly-settling participants to hold an account at the Bank which can be used for settlement.

In the case of LINK and Visa, the operators require a direct participant to have access to an account held with the Bank which can be used for settlement. As such there are a number of Direct Participants in the LINK and Visa system which settle indirectly across the account of one of the other Direct Participants. This arrangement is used by institutions that are not eligible for a settlement account with the Bank (for example, independent ATM operators).

Fair and open access

In deciding whether to provide an RTGS settlement account to an institution, the Bank will be guided by the eligibility criteria described above. However, access to a settlement account remains at the sole discretion of the Bank. The Bank will consider all applications for a settlement account in a fair and transparent manner whilst considering the risks that extending a settlement account would involve.

In addition to the risk of non-repayment of intraday liquidity and reputational risk, the Bank also needs to consider the financial stability impact that the failure of an institution holding a settlement account might have on the integrity of the payment system for which the Bank acts as settlement service provider.

Any organisation that meets the CHAPS criteria and requirements, as specified in the CHAPS Reference Manual, including holding an account in RTGS, has the ability to participate in CHAPS payment system as a Direct Participant. The precise timing of entry will be dependent upon a number of factors including access to a Reserves or Settlement account and technical readiness.

The Bank is, however, cognisant of the need as the systemic risk manager for the CHAPS payment system to balance its underlying operational and technical requirements with the need for strong risk management in the system. The CHAPS categorisation model provides an objective and risk-based methodology for ensuring that, where appropriate, less onerous requirements are in place for smaller participants whilst ensuring stronger requirements remain in place for participants that transmit more significant values or support large indirect participation.

Prospective CHAPS Direct Participants are categorised in advance of direct participation, which also ensures that less onerous requirements are in place at the point of joining the payment system e.g. tertiary connectivity requirements are not mandated for certain Direct Participants.

The Bank proactively seeks to provide fair and open access to a broad range of institutions. The Bank has expanded the perimeter of the type of institutions eligible for access to include institutions such as non-bank PSPs.

Key consideration 18.2: An FMI's participation requirements should be justified in terms of the safety and efficiency of the FMI and the markets it serves, be tailored to and commensurate with the FMI's specific risks, and be publicly disclosed. Subject to maintaining acceptable risk control standards, an FMI should endeavour to set requirements that have the least-restrictive impact on access that circumstances permit.

When determining the criteria for access to settlement accounts in RTGS, and direct participation in CHAPS, as well as when assessing individual applications, the Bank considers the benefits and risks to monetary and financial stability. For RTGS, it also considers risks to the Bank through use of its balance sheet, for example, credit risk through the provision of intraday liquidity, reputational risk, and operational risk. All reserves account holders are subject to appropriate prudential supervision; this provides a degree of assurance over governance, capital and liquidity. Non-reserves settlement account holders are typically subject to appropriate prudential supervision, either by the Bank in its role as supervisor of FMIs or by the FCA for non-bank PSPs.

To become a CHAPS Direct Participant, the entity must meet the definition of a "participant" as defined in the Financial Markets and Insolvency Regulations 1999. However, this requirement is in part risk-based, as it designed to be consistent with the designation of the CHAPS payment system under settlement finality regulations, therefore ensuring that the protection afforded to CHAPS payment via the Regulations remains valid.

A proportionate approach to access arrangements

The participation and access arrangements for different types of institutions vary based on the type of institution. Nonetheless, they have been designed so that the risk profile of RTGS/CHAPS is not materially increased by the opening up of access to new types of institutions.

For example, the Bank has worked with the FCA in the development of an enhanced supervisory regime for non-bank PSPs who want access to settlement accounts in RTGS, including both e-money institutions and other payment institutions. This ensures the widening of access to new types of participants to compete on a more level playing field does not impact the resilience of the system. Extending RTGS access to non-bank PSPs requires participants to comply with a comprehensive risk management framework to ensure that the resilience of RTGS and the broader sterling payment system is not compromised. This framework was developed by the Bank, working closely with the Financial Conduct Authority (FCA), HM Treasury, HM Revenue & Customs, the Payment Systems Regulator (PSR) as well as the retail payment system operators. The first non-bank PSP opened their settlement account in RTGS in April 2018.

The access criteria for RTGS and CHAPS are applied transparently and proportionately across all participants who must meet minimum compliance requirements via testing/trialling and self-certification against key requirements of the CHAPS Reference Manual. As noted above, the CHAPS Reference Manual proportionately categorises requirements according to risk posed to the CHAPS system.

Reviewing access criteria

The Bank's Settlement Account Policy for accounts in RTGS is reviewed periodically and in response to demand. The Bank is mindful of its public duty to ensure access is as open to as wide a population of organisations as possible, whilst also protecting the Bank's balance sheet. The opening up of RTGS to non-bank PSPs is an example of how the Bank has ensured participation requirements are the least restrictive possible whilst maintaining the Bank's risk profile. Participation criteria for CHAPS are also subject to comprehensive review periodically and in response to demand. Whilst a comprehensive review of the participation requirements happen every few years, the review of, and changes to, the operational and technical requirements happens more often. All material changes to the access requirements, particularly those that alter the risk profile, are subject to a non-objection from the Bank's Financial Market Infrastructure Directorate in their role as the non-statutory supervisor of the Bank as operator of the CHAPS system.

Disclosure of criteria

The criteria for access to settlement accounts in RTGS is published on the Bank's website in the Settlement Account Policy document. The Bank does not publish a list of institutions with accounts used for settlement (aside from CHAPS Direct Participants who are published by the Bank in its role as the payment system operator); it is for the payment system operators

to disclose, if they wish, the list of participants that settle directly in their respective systems. The Bank does not disclose a list of reserves account holders. Institutions with the same regulatory status are subject to the same access criteria.

The Bank publishes the CHAPS eligibility criteria on the CHAPS section of the website, together with links to the CHAPS Reference Manual and a summary of technical requirements. More detailed operational and technical requirements are disclosed to current and prospective CHAPS Direct Participants.

Key consideration 18.3: An FMI should monitor compliance with its participation requirements on an ongoing basis and have clearly defined and publicly disclosed procedures for facilitating the suspension and orderly exit of a participant that breaches, or no longer meets, the participation requirements.

Monitoring compliance

The Bank's and account holders' continuing rights and obligations are set out in the RTGS Terms & Conditions (and relevant annexes and associated CREST documentation). For CHAPS, the Bank's and Direct Participants' continuing rights and obligations are also set out in the CHAPS Reference Manual.

Account holders must inform the Bank of any operational changes that might be significant for its fulfilment of the qualification requirements or for the functioning of RTGS. On an ongoing basis, monitoring of a firm's eligibility to hold a reserves account lies with the Bank's Markets directorate for SMF participants. The situation where an entity loses eligibility for RTGS account access due a default event is covered under *Principle 13 – Participant default rules and procedures*. For non-bank PSPs, the FCA will inform the Bank where this could have a bearing on the Bank's decision to continue to provide an RTGS account to the non-bank PSP. The Bank monitors CHAPS Direct Participants' performance across a range of risk measures. The CHAPS annual participant assurance programme requires CHAPS Direct Participants to annual self-certification of compliance against the CHAPS Reference Manual. On rare occurrences the process does highlight certain areas of non-compliance. A consequence management framework exists regarding how Direct Participants are managed back to compliance, and if necessary how non-compliances are escalated. In extremis, this may include suspension or expulsion from the CHAPS payment system.

Suspension and orderly exit

The Bank reserves the right in its legal documentation to disable or terminate an RTGS account. For example, pursuant to the RTGS Terms & Conditions, it can do so where:

- there is an Event of Default (as defined in the Terms & Conditions);
- there is a breach of the Terms & Conditions or other requirements related to RTGS; or
- the Bank determines that it is necessary or desirable for its own protection or for the protection of the stability or efficient operation of the financial system.

Suspending an RTGS account is a relatively straightforward, well established and documented operational process. The Bank engages with account holders through its role as the sterling monetary authority and as prudential supervisor of deposit-takers and FMIs. For non-bank PSPs, the Bank engages with the FCA as the relevant prudential supervisor.

Internal guidance and processes facilitate the sharing of supervisory judgements and information with other areas of the Bank when necessary, for example if an account holder, including CHAPS Direct Participants, were presenting a significant risk to financial stability. Information on causes for exclusion, rights in connection with exclusion and requirements for warning and information are made publicly available in Section 9 of the RTGS Terms & Conditions. The payment system operators that settle through RTGS have their own processes for the suspension and exclusion of their respective settlement participants (which they are responsible for monitoring).

While the Bank reserves the right to disclose information where required in accordance with the RTGS Terms & Conditions, the Bank would generally not disclose such action to anyone other than the account holder and supervisors (and, if appropriate, relevant payment system operators if the account holder is a settlement participant). It would not generally disclose information to the public that could lead to speculation on the circumstances whereby an account holder may have been suspended or excluded from RTGS, because exclusion could lead to loss of confidence in an institution, presenting a risk to the Bank's mission of maintaining monetary and financial stability.

There is also a process for managing the suspension and orderly exit of a CHAPS Direct Participants that breaches or no longer meets the eligibility criteria, including if it poses a threats to the security, integrity or reputation of the CHAPS system. This can be found in Sections 5 and 6 of the CHAPS Reference Manual.

The CHAPS Reference Manual states the circumstances, policies and process for off-boarding a CHAPS Direct Participant. The CHAPS Reference Manual is disclosed in full on the Bank's website.

Principle 19- Tiered participation arrangements

An FMI should identify, monitor, and manage the material risks to the FMI arising from tiered participation arrangements.

Scope and applicability: Tiered participation occurs when direct participants in a system provide services to other institutions to allow them to access the system indirectly.

Tiered participation occurs within the CHAPS payment system.⁴⁵ This self-assessment therefore covers the operation of CHAPS

However, with respect to RTGS account holders, they engage with the Bank as principal rather than as an agent. As such, the Bank does not consider that this principle applies to its role as operator of RTGS and provider of settlement in central bank money, and has therefore not assessed itself against it. As an accounting system, RTGS accepts settlement instructions from account holders to transfer funds from their account to another account holder. In that regard, there is limited technical or operational risk that arises from tiering.

Tiering does however exist in the payment systems that settle across accounts held in RTGS. Although no risks to the Bank, as operator of RTGs, stem from tiered accounts in payment system, tiering does introduce broader risks to financial stability, and hence is an ongoing concern for the Bank across its broader central banking functions. The Bank works with the payment system operators and account holders to reduce such risks across a number of fronts.

Operators of systemically important payment systems are supervised by the Bank's FMI directorate. The regulatory regime is framed by the PFMLs, and operators are expected to monitor and manage tiering risks within their systems accordingly. The Bank, as operator of RTGS, has previously worked with the operator of EUI to increase the number of CREST settlement banks. And the PRA, as the prudential supervisor of banks, encourages first-tier firms to consider the risks associated with the services they provide to others and, in some cases, encourage or require a second-tier firm to move to direct access.

Rating: Observed (CHAPS)/Not applicable (RTGS)

Summary of compliance: Certain CHAPS Direct Participants (DPs) provide payment services that allow other financial institutions to access CHAPS indirectly. This is known as

⁴⁵ An introduction to tiering in CHAPS was given in <https://www.bankofengland.co.uk/-/media/boe/files/quarterly-bulletin/2013/tiering-in-chaps>

'tiering' and the higher the proportion of system activity arising from Indirect Participants through Direct Participants, the more 'tiered' the system is.⁴⁶

Tiering arrangements in CHAPS are regularly monitored by the Bank using data provided by the Direct Participants as well data taken directly from CHAPS settlement instructions. The Bank has clear quantitative criteria for identifying tiered relationships. These criteria are published and kept under review. Crystallised breaches and near breaches of these criteria, as well as the overall concentration within the system are reviewed within the RTGS/CHAPS risk framework.

The number of CHAPS Direct Participants has more than doubled – from fourteen to over thirty – since the 2007 -2008 financial crisis. ING joined CHAPS in May 2018 and was the last to join of the six banks identified by the Bank as systemic in 2011 as part of a one-off exercise. Nevertheless, CHAPS continues to be a highly tiered although, as at the point of assessment, the Bank has not identified any indirect participants who process more than 2% of the total CHAPS system value under the CHAPS tiering criteria which were subsequently introduced.

Key consideration 19.1: An FMI should ensure that its rules, procedures, and agreements allow it to gather basic information about indirect participation in order to identify, monitor, and manage any material risks to the FMI arising from such tiered participation arrangements.

As at 30 June 2018, the CHAPS payment system had 31 Direct Participants, an increase of five over the previous year. CHAPS is a relatively highly tiered system, particularly when compared to peer international high-value payment systems. This is largely due to the concentration in the UK banking system and the global nature of the UK's financial sector, resulting in a large number of international financial institutions electing for indirect access. 31 Direct Participants represents a significant increase in direct access over the last few years, meaning that CHAPS is significantly less tiered, relative to if the population had remained constant.

Data on indirect participation is reported to the Bank quarterly by DPs, as applicable. Each DP is required to notify and seek approval from the Bank for any significant new indirect participant relationship i.e. if the average daily value is predicted to be £150m or more.

The potential material risks to the CHAPS system and financial stability arising out of tiered participation arrangements are credit, liquidity and operational risk. Certain payments are also important by virtue of their nature e.g. margin payments to CCPs and CLS pay-ins.

- The extent of the credit risk is dependent on the size and fluctuations of the flows between DPs and their indirect participants. The tiering criteria are designed to directly address this risk through direct access where there are not sufficient mitigating circumstances.
- DPs and their indirect participants require intraday liquidity to make CHAPS payments. Each may rely on the other to provide some, or all, of this liquidity. Risks to the system arise if payments cannot be made – particularly in stressed circumstances – following liquidity being withdrawn. The associated liquidity risk is monitored through an assessment of tiered concentration risk, with a view to mitigating through direct participation, where appropriate.
- An operational incident at a DP can mean that its indirect participants may not be able to make their payments unless alternative arrangements are in place.

The Bank expects mitigants to be in place regarding payment flows. These are assessed as part of the annual participant assurance process. Further information on these mitigations are set out in the CHAPS Reference Manual.

Key consideration 19.2: An FMI should identify material dependencies between direct and Indirect Participants that might affect the FMI.

The largest dependencies between DPs and indirect participants are identified by assessing the tiering data submitted by DPs against the tiering criteria set out in the CHAPS Reference Manual (and detailed below). Stress and scenario testing is also undertaken to assess the risks arising from significantly tiered relationships in various stressed scenarios.

Key consideration 19.3: An FMI should identify Indirect Participants responsible for a significant proportion of transactions processed by the FMI and Indirect Participants whose transaction volumes or values are large relative to the capacity of the Direct Participants through which they access the FMI in order to manage the risks arising from these transactions.

The tiering data collected by the Bank is used to identify indirect participants responsible for a significant proportion of transactions by value. This assessment is taken relative to the system as a whole as well as relative to the DP(s) through which they access CHAPS. The

Bank also identifies which DPs process a significant value – in absolute and relative terms – on behalf of indirect participants.

The tiering criteria are that:

1. the average daily value of CHAPS payments sent and received for, or on behalf of, the indirect participant⁴⁷ exceeds 2% of the CHAPS system; or
2. the average daily value of CHAPS payments sent and received for, or on behalf of, the indirect participant exceeds 40% of the average daily value of CHAPS payments and other internalised (often known as 'on-us') CHAPS payments settled across the books of the relevant DP.

The CHAPS tiering criteria set out the circumstances when the Bank could withdraw consent for a specific tiering relationship in the absence of sufficient mitigating circumstances, in order to enable the indirect participant to move to direct access. Presumptive breaches or near-breaches of the tiering criteria are considered within the risk management framework that covers RTGS and CHAPS.

Beyond specific breaches, the Bank regularly undertakes a quantitative analysis of concentration risk, as well as a qualitative assessment of how tiered relationships might operate in normal and stressed scenarios. Continued compliance is monitored through the regular participant assurance programme.

DPs are expected to work with their indirect participant(s) to address any potential breach. If an indirect participant has been identified as potentially breaching a threshold, the Bank engages with all DPs sponsoring the relevant indirect participant. Mitigating options may include the indirect participant joining CHAPS directly, going through other DPs or medication to the relationship between the DP and its indirect participant greater operational, financial or legal controls.

Key consideration 19.4: An FMI should regularly review risks arising from tiered participation arrangements and should take mitigating action when appropriate.

The tiering criteria in the CHAPS Reference Manual are reviewed regularly. In particular, a change in the CHAPS population resulting in new types of DPs would lead to a review of the applicability of the criteria. For example, the tiering criteria were reviewed in light of planned admission of ring-fenced banks, aggregators and non-bank Payment Service Providers.

⁴⁷ Including related entities within the same financial group

The CHAPS tiering criteria are positioned such that there is a presumption that the Bank, as CHAPS operator, will use its powers to withdraw consent within twelve months in relation to a breach of the tiering criteria. The exception to this is if a DP or their indirect participant can demonstrate countervailing factors and argue that the Bank using its powers for suspending or withdrawing consent where a breach has been identified would lead to deterioration in financial stability. A DP has the ability to request a review of the executive's judgement of a breach of the tiering criteria. The review panel would be formed of a group of one or more external RTGS/CHAPS Board members (subject to conflicts).

Principle 21-Efficiency and Effectiveness

An FMI should be efficient and effective in meeting the requirements of its participants and the markets it serves.

Scope and applicability: The Bank, as operator of RTGS and CHAPS, aims to be efficient and effective in meeting the requirements of participants and the wider market those participants support. For the retail systems, this is primarily the responsibility of the retail payment system operators with the Bank's focus typically limited to the settlement arrangements.

Rating: Observed

Summary of compliance: The Bank prioritises the reduction of risks to monetary and financial stability in its design and operation of the RTGS and CHAPS services. Wherever it can do so without compromising stability, the Bank seeks to provide value for money and functionality demanded by users.

Bringing responsibility for CHAPS into the Bank has enabled the Bank to integrate the operation of RTGS and CHAPS under a single governance and risk management framework. This now ensures that a single organisation – the Bank – has control over the operations, technology and procedures to deliver the CHAPS system.

The Bank engages with a wide range of stakeholders in the RTGS and CHAPS services, in order to understand the needs of users. This is achieved through a range of interactions, including group meetings with CHAPS Direct Participants, bilateral engagements with stakeholders, and a range of forums such as the CHAPS Strategic Advisory Forum and the RTGS renewal programme's External Advisory Body.

Key consideration 21.1: An FMI should be designed to meet the needs of its participants and the markets it serves, in particular, with regard to choice of a clearing and settlement arrangement; operating structure; scope of products cleared, settled, or recorded; and use of technology and procedures.

The Bank seeks to ensure that it is taking into account the needs/interests of its participants, key stakeholders and the markets it serves through the provision of the CHAPS and RTGS services.

CHAPS

The Bank undertakes regular engagement with the CHAPS Direct Participants (DPs) to seek feedback. This is done through a range of groups that include topics such as assurance, rules, liquidity, testing, and operations. In addition, DPs are normally consulted when considering changes to the CHAPS Reference Manual and other requirements, particularly where there may be a cost/impact on them of such a change.

The Bank also engages at a strategic level bilaterally with each DP and through the CHAPS Strategic Advisory Forum, which includes DPs, indirect participants and end-users and is chaired by an external member of RTGS/CHAPS Board.

The Bank seeks to ensure that requirements on CHAPS DPs are proportionate to the risks they bring to the CHAPS service. Under the CHAPS Reference Manual, DPs are categorised according to the potential risk each poses to CHAPS. The participation requirements of less systemic DPs are less onerous, in places, to reflect the lower risk posed to CHAPS service.

RTGS

RTGS fulfils multiple functions, including real-time gross settlement for CHAPS and CREST, holding reserves accounts underpinning the implementation of monetary policy and the provision of liquidity to the financial system, as well as net settlement for several retail payment systems. When considering the objectives for, and design of, RTGS, the Bank aims to balance the needs of its diverse users and the broader aims of public policy. Those needs are often aligned; however, at times the Bank may need to make trade-offs between competing objectives, or prioritise investment of changes to functionality.

When the Bank plans major investment or change projects related to RTGS it engages with the payment system operators, account holders and, where appropriate, with end-users such as corporates. Over the previous years, the Bank in its role as the RTGS operator has introduced a number of features to meet the needs of account holders and payment system operators, including: a business intelligence tool and Liquidity Saving Mechanism for DPs; MIRS as an additional contingency infrastructure in the event of a failure to the RTGS infrastructure; and cash prefunding using reserves to eliminate settlement risk in Bacs and Faster Payments.

As part of the RTGS Renewal Programme, the Bank is also committed to gathering industry wide input into the design and development on the new RTGS system. The Bank holds regular External Advisory Body (EAB) meetings and working groups in which a broad range of stakeholders are represented. The Bank has sought to encourage wider engagement on

key topic areas through open call workshops, bilateral engagement with other key stakeholders, industry events and public consultations. The broad scope of the Bank's engagement, with both financial services and non-financial services stakeholders has allowed it to identify and implement significant advancements to RTGS, current and future.

Key consideration 21.2: An FMI should have clearly defined goals and objectives that are measurable and achievable, such as in the areas of minimum service levels, risk-management expectations, and business priorities.

Defining objectives

The RTGS/CHAPS Strategy was agreed at the RTGS/CHAPS Board meeting of March 2018. The strategy included a mission statement for the Bank's operation of the RTGS/CHAPS services, consistent with the Bank's overall mission. This sets out that the purpose of the services is to deliver:

the Bank's Financial and Monetary Stability mission by providing a well-run, resilient and responsive RTGS infrastructure that enables access to central bank money accounts and payment services; and the Bank's Financial Stability mission by providing a reliable, resilient and responsive system for high value sterling payments.

For CHAPS, in line with the Bank's mission, the Bank seeks to act as an end-to-end, systemic risk manager – assessing, managing, and responding to the full range of risk arising from all points within the system. The Bank also seeks to promote efficiency, innovation and competition in sterling payments, where that can be safely done without impairing stability. For RTGS, enhancements are made periodically in order to mitigate risks to the Bank's mission and RTGS/CHAPS mission statement.

The Strategy also set out strategic vision for the future RTGS/CHAPS combined infrastructure, which is:

- a renewed RTGS infrastructure for the UK that offers the service, resilience and responsiveness required to consistently deliver the Bank's Financial and Monetary Stability mission in an evolving environment;
- a high value payments scheme, with an enhanced proactive end-to-end/systemic risk management approach at its core, that is integrated into the Bank and consistently delivers a responsive, well run and resilient payment system to its users.

The RTGS/CHAPS executive records and tracks the key actions/deliverables required during the year to meet the RTGS/CHAPS Strategy, both in terms of overall timelines and

specific milestones for each piece of work, and escalates any resourcing or timing issues to Board Risk Committee or Board where appropriate. Deliverables set by the Board are measurable and challenging but achievable.

Evaluating progress

In the period since responsibility for CHAPS transferred to the Bank, an early focus has been on greater integration of the internal governance and risk management of RTGS and CHAPS. This seeks to deliver a reduction in risk to financial stability as well as greater efficiency and effectiveness of internal governance.

The Bank also prioritises the safe and reliable operation of the RTGS and CHAPS services. The initial goals for RTGS (and CHAPS) set out in the Blueprint in 2017 regarding the delivery model for the UK HVPS have been delivered. In particular, the operation of the CHAPS system is integrated within the Bank with no degradation of service (including no interruption to regular CHAPS processes, no crystallisation of identified risks and 100% availability over Q2 2018). CHAPS and RTGS teams have been integrated across the business functions (operations, risk, analysis and governance). The Bank has set the foundations for an end-to-end systemic risk management approach through detailed design. The Bank is beginning to harness the benefits of drawing on access to wider expertise e.g. in cyber risk management. Progress against these strategic goals is assessed at Board.

The Bank has evaluated the processes that it is responsible for and concluded that it is being as flexible as it can be in these areas under the current RTGS infrastructure whilst maintaining integrity and resilience. There is recognition amongst participants that the Bank is aiming for high standards regarding systemic risk irrespective of what is demanded by comparative systems.

Where the Bank is unable to further streamline the process at present without compromising the resilience and integrity of the Bank systems, the Bank is incorporating the feedback in to the design specification of the renewed RTGS infrastructure. In May 2017, the Bank published the Blueprint which set out its vision for the renewed RTGS service, following an industry wide consultation. As part of the Blueprint, the Bank set out its plans for streamlined testing and onboarding for CHAPS Direct Participants.

The Bank is committed to a materially more efficient testing regime for CHAPS DPs in the renewed RTGS service that maintains or enhances the resilience and security of the system but is less onerous on participants. In particular, the Bank will introduce automated testing and simulators, and will design the new system to ensure the risks involved in making

common changes, such as adding new DPs, are minimised. Taken together, the expectation is that the amount of testing required for such changes should be substantially reduced.

A new testing framework reflects the responses to the consultation, which showed the current testing regime to be the most frequently-cited burden on participants wanting to join CHAPS, and a potential barrier to direct participation. The second most frequently-cited burden was the on-boarding process for new DPs. The Bank will explore ways to continue to streamline this process.

A key focus of the combined RTGS/CHAPS delivery is transparency. The RTGS/CHAPS Board is committed to seeking feedback from participants and users and taking into account feedback received when making decisions. The new communication channels described above are examples of this approach, designed to explain the rationale for why decisions are possible as much as possible.

Key consideration 21.3: An FMI should have established mechanisms for the regular review of its efficiency and effectiveness.

A range of performance and risk indicators are produced covering the RTGS and CHAPS services. These are used by the executive and the RTGS/CHAPS Board to consider the efficiency and effectiveness of the RTGS and CHAPS services.

The annual tariff review process is periodically reviewed by the Bank's internal audit function. Standard investment projects are considered through the Bank's standard project management process (with costs usually recovered directly from relevant account holders). The process for recovery of the costs involved in the RTGS Renewal Programme is covered under *Principle 15-General Business Risk*. The costs associated with the RTGS and CHAPS services, the process of their recovery, are communicated to relevant account holders, together with an explanation for any significant changes (positive or negative) to charges. The budget / overall cost base for the RTGS and CHAPS service is also reviewed as part of the Bank's annual budget round.

Processes are reviewed on an annual basis to review whether all processes are still required, and for potential improvements.

The Bank also engages externally to understand their perspective on the efficiency and effectiveness of RTGS and CHAPS. The core focus continues to be on the RTGS Renewal Programme including how the industry transition to the renewed RTGS service, including the adoption of the ISO 20022 messaging standard for CHAPS.

Principle 22-Communication procedures and standards

An FMI should use, or at a minimum accommodate, relevant internationally accepted communication procedures and standards in order to facilitate efficient payment, clearing, settlement, and recording.

Scope and applicability: Applicable to both CHAPS settlement instructions as well as other messages sent and received by RTGS.

Rating: Observed

Summary of compliance: Messages sent and received by RTGS, including CHAPS settlement instructions, use SWIFT messaging formats.

The Bank will adopt the ISO 20022 message standard for CHAPS as part of the renewed RTGS infrastructure. In June 2018, the Bank jointly consulted with Pay.UK on moving to a UK 'Common Credit Message' using ISO 20022.

Key consideration 22.1: An FMI should use, or at a minimum accommodate, internationally accepted communication procedures and standards.

All payment messages involving RTGS, including CHAPS payment messages, use internationally accepted communication procedures which are commonly used for high-value payment systems (SWIFT FIN). SWIFT FIN messages have been the de-facto international standard for many years. The Bank owns the CHAPS message standard. Many of the fields are used to communicate information about the ultimate beneficiaries and senders – this supports reconciliation as well as screening for financial crime.

The Bank will adopt the ISO 20022 messaging standard for CHAPS as part of the renewed RTGS infrastructure. In June 2018, the Bank jointly consulted with Pay.UK on moving to ISO 20022. ISO 20022 is a globally-agreed and managed method for financial messaging standards which has an open standard, is network agnostic and will increase data carrying capacity with an improved structure. Following the assessment, the Bank and Pay.UK published a consultation response document in November 2018. They have jointly set up a Standards Advisory Panel to seek industry views on the adoption of ISO 20022, which will meet for the first time in early 2019.

The Bank uses a SWIFT message type for settlement instructions submitted to RTGS by retail payment systems and has set out its own domestic standard.

The Bank provides a separate portal, the Enquiry Link, for payment queue management and liquidity management. This uses a proprietary messaging standard developed by the Bank and is accessed via SWIFT.

Principle 23-Disclosure of rules, key procedures and market data

An FMI should have clear and comprehensive rules and procedures and should provide sufficient information to enable participants to have an accurate understanding of the risks, fees, and other material costs they incur by participating in the FMI. All relevant rules and key procedures should be publicly disclosed.

Scope and applicability: RTGS and CHAPS have separate sets of rules and procedures.

For many FMIs, rules set out how system participants engage with the operator of the system as well as each other, including management of risks to and from other participants.

- This is the approach following for CHAPS documentation with parts of the documentation describing how DPs should behave with respect to each other.*
- For RTGS's role as the settlement agent for other FMIs, the RTGS Terms & Conditions (and associated CREST documentation) are a bilateral relationship between the Bank and each account holder only.*
- Interaction between account holders in the context of their system participation for example, in Bacs or CREST, is governed by the rulebooks and legal documentation owned and managed by the payment system operators.*

Rating: Observed

Summary of compliance: The Bank publishes a comprehensive set of the documentation relating to the RTGS and CHAPS services. This includes the documents describing the rules, responsibilities and risks associated with the operation of both RTGS and CHAPS; the RTGS Terms & Conditions (with accompanying annexes) and the CHAPS Reference Manual. Additional information regarding the governance, cost recovery and user consultation within the RTGS/CHAPS systems is also disclosed on the Bank's website.

Certain information is disclosed on a need-to-know basis to the Direct Participants, applicants, payment system operators and RTGS account holders. This is typically more sensitive information relating to technical matters and security.

Key consideration 23.1: An FMI should adopt clear and comprehensive rules and procedures that are fully disclosed to participants. Relevant rules and key procedures should also be publicly disclosed.

Rules and procedures

The RTGS Terms & Conditions (and associated annexes and CREST documentation), alongside the Bank's Settlement Account Policy, set out entry, continuing and exit requirements for access to an RTGS account. These are clear and comprehensive, and subject to review periodically. In practice, changes to the RTGS Terms & Conditions are driven by functional or policy changes. Changes made to any legal documentation are subject to thorough internal (and if necessary, external) review to ensure they are clear and comprehensive. The RTGS Terms & Conditions (and associated annexes and CREST documentation) include provisions covering the process, and circumstances in which they can be amended and/or waived. Any substantial changes are agreed through the RTGS/CHAPS governance process in conjunction with the Bank's legal advisors.

The Bank provides the RTGS Reference Manual and other documents to account holders and, where relevant, the payment system operators. The RTGS Reference Manual is updated on a regular basis. Documentation between the Bank and each payment system operator set outs relevant information for the Bank's interaction with each operator and, where relevant, their directly-settling participants.

The RTGS Terms & Conditions are published on the Bank's website (including service-specific annexes). Other documents, including the RTGS Reference Manual, Enquiry Link Guide, documentation covering CREST settlement, and agreements with the payment systems operators, are made available to current and potential account holders and/or the relevant payment system operators.

The key document that sets out the CHAPS rules and procedures is the CHAPS Reference Manual and this is publically disclosed on the Bank's website.

Other documents including the CHAPS Participation Agreement, the CHAPS Operations Reference Manual, CHAPS Technical Reference Manual, and Cloud/Aggregator requirements are disclosed to Direct Participants (and applicants) but are not published.

Disclosure

The RTGS Terms & Conditions (and associated CREST documentation) set out the steps that the Bank would take in non-routine events, including disablement and termination of accounts (including defining what constitutes a default). It also makes clear that the Bank has ultimate discretion to make unilateral changes if necessary for the UK's financial stability.

Rule changes follow a proportionate notification process. RTGS account holders will generally be notified of minor changes with an immaterial impact. For material changes, the

Bank has a public duty obligation to consult widely e.g. on significant changes to its operations. In this event, the Bank will generally design a consultation process which is appropriate for the nature of the change. For example, extending the RTGS/CHAPS settlement day in 2016 was subject to significant engagement with CHAPS Co, Euroclear UK and Ireland, Direct Participants, and parts of the wider user community.

Appropriate measures are in place to deal with non-routine but foreseeable events involving the provision of CHAPS. These are set out in the CHAPS Rules, the CHAPS Operational Reference Manual, the CHAPS Technical Manual and key incident management and resilience policies and procedures. The documents are reviewed at least annually.

Specifically, information on extensions and the processes Direct Participants follow are covered in the CHAPS Reference Manual. The Bank has wide discretion to make changes to the settlement day to maintain financial stability and the Bank will keep in close communication with Direct Participants to ensure they are appropriately informed. The steps that the Bank can take to vary the timings relating to its operation of CHAPS following non-routine events are listed.

The CHAPS Reference Manual contains information regarding the internal change process. Information on changes made will be disclosed to Direct Participants. The Technical & Operations Committee is a key conduit. And one of its working groups will typically be engaged on the nature of changes before changes are formally made.

Key consideration 23.2: An FMI should disclose clear descriptions of the system's design and operations, as well as the FMI's and participants' rights and obligations, so that participants can assess the risks they would incur by participating in the FMI.

The Bank's website provides information on the design and operations of RTGS and CHAPS, including service availability statistics. There are a number of articles published in the Bank's Quarterly Bulletin that provide further information on particular aspects of the design and operation of the RTGS and CHAPS services. A description of the RTGS and CHAPS service is published alongside the Bank's self-assessment of RTGS and CHAPS against the PFMI.

The Bank discloses the rights and circumstances in which the Bank can exercise discretion (for example, if necessary for the UK's financial stability).

As set out in the PFMI, information is only disclosed to the extent it would not, amongst other things, risk prejudicing the security and integrity of the FMI or release commercially sensitive information.

RTGS

The RTGS Reference Manual describes the technical details of RTGS to account holders from a user's perspective. It is shared with potential account holders at an appropriate point in the application process. Rights and responsibilities within RTGS are set out in the RTGS Terms & Conditions, including the annexes and, where relevant, the associated CREST documentation.

CHAPS

Documents comprising information about the CHAPS systems design and operations include the CHAPS Reference Manual, the CHAPS Operational Reference Manual and the CHAPS Technical Reference Manual. These are shared with potential DPs at an appropriate point in the application process. The CHAPS Reference Manual is published on the Bank's website.

Rights and responsibilities within the CHAPS system are set out in the CHAPS Reference Manual (specifically the Rules) and the CHAPS Participation Agreement.

Key consideration 23.3: An FMI should provide all necessary and appropriate documentation and training to facilitate participants' understanding of the FMI's rules and procedures and the risks they face from participating in the FMI.

The Bank provides relevant documentation related to RTGS and CHAPS to account holders, including CHAPS DPs, and payment systems operators to facilitate their understanding of the RTGS and CHAPS services and the risk they face from participating. However, information is only disclosed to the extent it would not, amongst other things, risk prejudicing the security and integrity of RTGS or CHAPS, the Bank and the financial system or release commercially sensitive information.

RTGS

The Bank has a defined process for on-boarding new RTGS account holders – or for a change to the account type – and supports account holders through the application procedure. This includes guiding them through costs, modelling their potential intraday liquidity needs and providing the requisite supporting documentation.

The Bank's support of RTGS account holders continues after on-boarding as necessary. The Bank has also run education sessions when new tools or services are delivered. For example, the Bank delivered a range of support ahead of the introduction of the Liquidity Saving Mechanism as well as cash prefunding.

CHAPS

Standardised and structured on-boarding support for CHAPS is provided through a dedicated team. Each potential DP has access to the full set of legal and process documentation.

Prior to being allocated an on-boarding slot in CHAPS, a potential DP will be assessed for its readiness to join. A series of workshops is delivered to seek to ensure that the potential DP understands the rules, procedures and the risks associated with participating in CHAPS.

The Bank undertakes assurance of CHAPS DPs against their ability to meet the rules and requirements set out in the CHAPS Reference Manual. The Bank may identify a DP's lack of understanding through this assurance work and supporting self-certification process. The Bank has a number of options available to address such shortcomings including education as well as escalation through the consequence management process.

Key consideration 23.4: An FMI should publicly disclose its fees at the level of individual services it offers as well as its policies on any available discounts. The FMI should provide clear descriptions of priced services for comparability purposes.

The Bank publishes its fees policies and tariff on its website. The Bank's documentation describes the services provided and how they are provided. No discounts are available. Tariffs for RTGS settlement (including CHAPS) and the CHAPS 'scheme' are set for the year in advance and RTGS account holders, including CHAPS DPs, are given written notice before any change, together with an explanation of any changes.

The Bank provides CHAPS DPs and Euroclear UK and Ireland sight of relevant operating costs and investment plans as part of this annual process. The retail payment system operators are consulted where any substantive investment plans would affect them, and they would be expected to cover the Bank's costs.

Key consideration 23.5: An FMI should complete regularly and disclose publicly responses to the CPMI-IOSCO disclosure framework for financial market infrastructures. An FMI also should, at a minimum, disclose basic data on transaction volumes and values.

This self-assessment is published alongside the Bank's response to the disclosure framework for the RTGS and CHAPS services. Responsibility for operating the CHAPS payment system transferred to the Bank in November 2017. The Bank intends to publish a

self-assessment of its operation of the RTGS and CHAPS services on a broadly annual basis.

Data on values and volumes are regularly published on the Bank's website for each payment system settling over RTGS, together with information about RTGS's monthly availability.

- For CHAPS, gross volumes and values are published on the Bank's website as well as a description of summary trends.
- For CREST and the retail systems, the volumes and values reflect the net settlement across RTGS, not gross volumes and values.

The Bank, as prudential supervisor of payment systems, publishes annual values and volumes settled in CHAPS, CREST and some of the retail payment systems.⁴⁸

The Bank publishes the RTGS Terms & Conditions, the CHAPS Reference Manual, fee policies and tariffs. The Bank also publishes: RTGS/CHAPS Board responsibilities and member biographies; the Terms of Reference and summaries from the CHAPS Strategic Advisory Forum and the RTGS Renewal Programme's External Advisory Body; and a list CHAPS DPs.

⁴⁸ <https://www.bankofengland.co.uk/news/2018/february/supervision-of-financial-market-infrastructures-annual-report-2018>

