



MacBook (Retina, 12-inch, Early 2016)

MacBook (Retina, 12-inch, 2017)

Apple Recycler Guide

July 2023

Contents

3	About This Guide
4	Identification
5	Directive 2012/19/EU Annex VII Components
6	Safety Considerations
9	Recommended Tools
10	Disassembly Instructions
27	Material Categorization of Output Fractions

About This Guide

Apple Recycler Guides provide guidance for electronics recyclers on how to disassemble products to maximize recovery of resources. The guides provide step-by-step disassembly instructions and information on the material composition to help recyclers direct fractions to the appropriate material recycler.

To conserve important resources, we work to reduce the materials we use and aim to one day source only recycled or renewable materials in our products. A key path to reaching that goal is resource recovery from end-of-life electronics.

Disassembly procedures are intended to be performed only by trained electronics recycling professionals. The recycler is responsible for independently evaluating and ensuring compliance with all applicable environmental, health, and safety laws related to the work. These include but are not limited to laws relating to the management, handling, shipping, and disposal of the outputs of this work as waste and laws in place to ensure the health and safety of all employees who support this work.

For questions or feedback about this guide, email contactesci@apple.com.

Note: This guide may show images from other similar models, but the procedures are the same.

Identification

You can find the model number printed on the underside of the MacBook, near the regulatory markings.

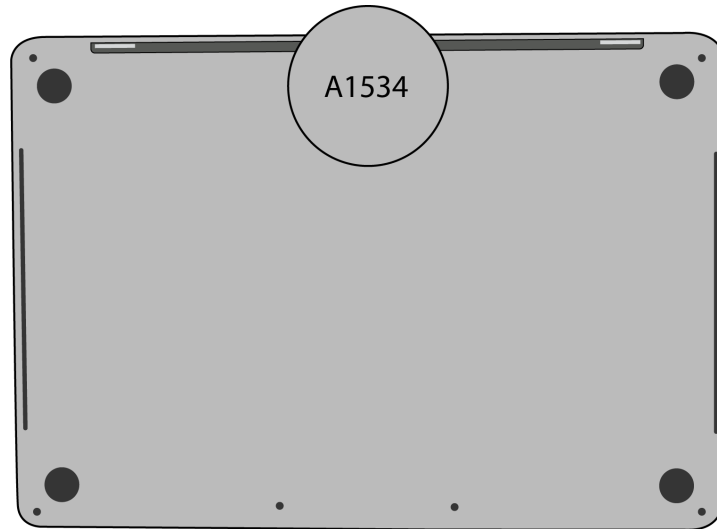

Model number:
A1534

Directive 2012/19/EU Annex VII Components

Directive 2012/19/EU Annex VII requirements apply to the following substances and components.

Substance/Component	Apple Part Name	Removal Instructions
Printed circuit board if the surface is greater than 10 square centimeters	Main logic board, battery logic board, trackpad, keyboard, data board assembly, and light-emitting diode (LED) logic board	Follow steps 1–20
External electric cables	Charge cable	Follow step 1
Battery	Lithium-ion polymer batteries	Follow steps 1–3
Cover glass and liquid crystal display (LCD) cell if the surface is greater than 100 square centimeters	LCD cell	Follow steps 1–16
No further substances or components as listed in Annex VII		

Safety Considerations

The recycler is responsible for independently evaluating all activities undertaken by its employees to perform or support the work and ensuring compliance with all applicable health and safety laws related to the work. These include but are not limited to laws relating to the health and safety of all employees who perform or support this work. The recycler is also responsible for evaluating the workspace and ensuring that the area in which the work is to be undertaken is designed using ergonomic best practices and meets all ergonomic requirements to ensure the protection of its employees.

Personal Protective Equipment

Personal protective equipment should be worn during the entire recycling process.



Wear hand protection



Wear a mask



Wear eye protection



Wear foot protection



Wear protective clothing

Battery Safety

This product uses a lithium-ion polymer battery. Before beginning any disassembly work, ensure that a safe working procedure for handling lithium-ion batteries has been established, which could include discharging the batteries so that they can be more safely managed. The following considerations may also be included:

- Remove anything from your person that could conduct energy, such as jewelry and watches, to avoid electric shock to yourself or the logic board.
- To avoid the potential for thermal runaway and the release of potentially noxious fumes, don't puncture, strike, or crush lithium-ion polymer batteries or devices powered by them.
- Don't throw, drop, or bend the battery.
- Don't expose the battery to excessive heat or sunlight.
- Don't use tools that are sharp or conduct electricity.
- Keep your workspace clear of foreign objects and sharp materials.
- Dispose of batteries according to local environmental laws and guidelines.

Workspace safety guidelines

- Use heat-resistant gloves and safety glasses.
- Keep a sand dispenser within arm's reach (2 feet or 0.6 m) on one side of the workstation, not above the workstation. The dispenser should be a wide-mouthed, quick-pour metal container with a flip-top lid or tray that contains 8–10 cups (1.9–2.4 L) of clean, dry, untreated sand.
- Keep the battery at least 2 feet (0.6 m) from paper and other combustible materials.
- Work in an area with adequate ventilation.

Handling a thermal runaway

If you notice any of the following signs, a thermal runaway is likely underway, and you should act immediately:

- The lithium-ion polymer battery or a device containing one begins to smoke or emit sparks or soot.
- The battery pouch suddenly and quickly puffs out.
- You hear hissing or popping sounds.

Don't use water or an ABC/CO₂ fire extinguisher on a thermal runaway battery or a device containing one. Water and ABC/CO₂ fire extinguishers will not stop the reaction.

Do smother the battery or device immediately with plenty of clean, dry sand, dumped all at once. Timing is critical; the faster you pour all the sand, the faster the thermal runaway will stop.

Do leave the room for 30 minutes if the thermal runaway causes any irritation.

Do wait 30 minutes before touching the battery. Wear heat-resistant gloves and safety glasses to remove the battery from the sand, or use a touchless thermometer to measure the battery temperature. Only touch the battery when the event has finished.

Do dispose of the damaged battery or device (including any debris removed from the sand) according to local environmental laws and guidelines.

LED Safety

Broken LEDs must be handled properly to ensure the safety of your employees and mitigate any hazards. Package broken LEDs in an appropriate container to properly manage the hazards associated with the materials and store only with compatible materials. All waste must be properly classified, packaged, and labeled in accordance with all relevant laws and regulations.

Hazard Warnings



Rechargeable battery hazard



Chemical exposure hazard



Broken glass hazard



Chemical inhalation hazard

Recommended Tools

Flat surface scraper

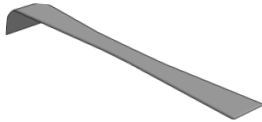

Long-nose pliers

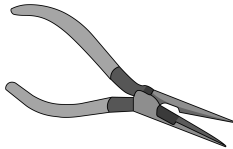

Miniature pry bar

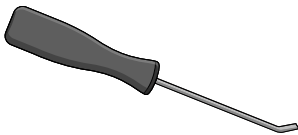

Nail-pulling screwdriver

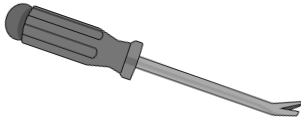

Phillips screwdriver

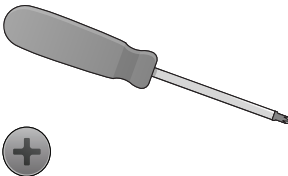

Plastic pry bar

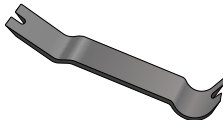

Precision pick

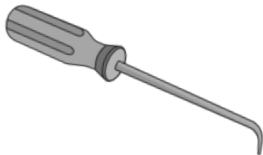

Torx T3 screwdriver

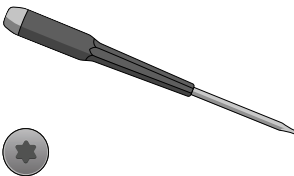

Torx T5 screwdriver

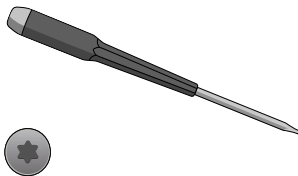

Torx T8 screwdriver

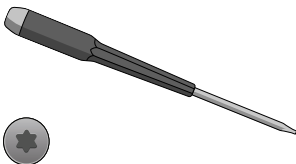

Wire cutters

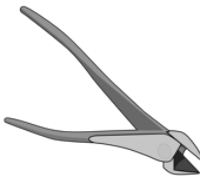

Disassembly Instructions

1. Remove the power adapter and the charge cable.

» *Ensure that the MacBook is turned off.*



» *Unplug the power adapter and remove the charge cable.*

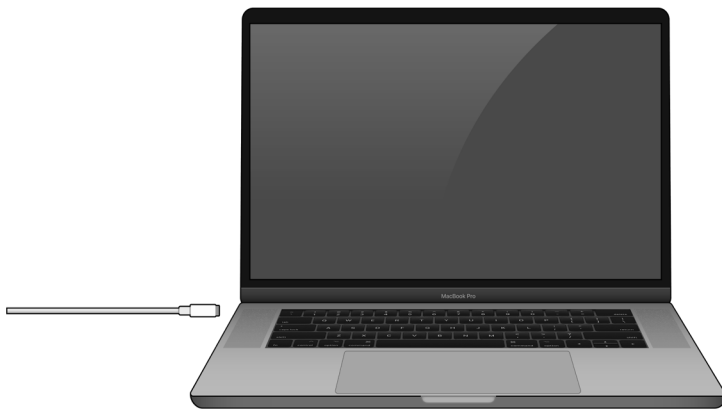

Fraction



Power adapter



Charge cable

Cu

Copper

2. Carefully pry off the bottom case. To avoid damaging the batteries, only pry near the fastener attachments.

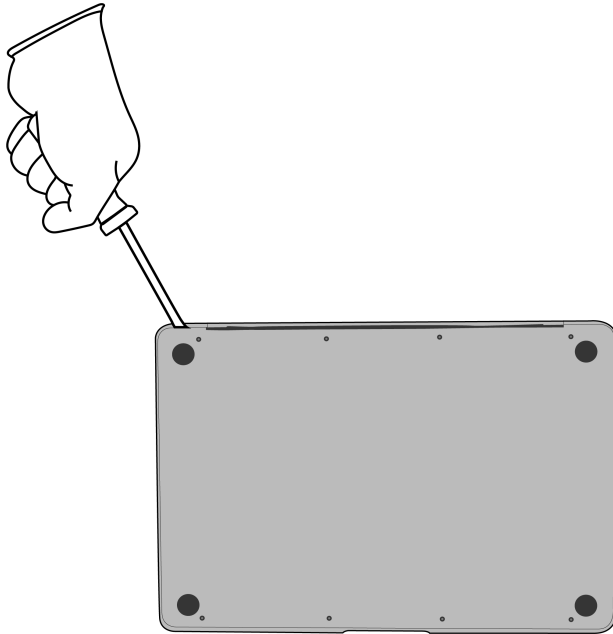

Tools Used



3. Inside the bottom case, carefully remove the six lithium-ion polymer batteries.



Rechargeable battery hazard

Tools Used

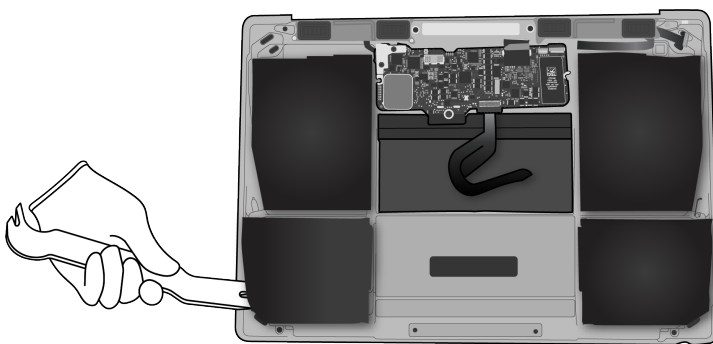
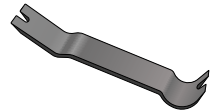

Fraction



Lithium-ion polymer
batteries

BT

Battery

4. Pry off both speakers.

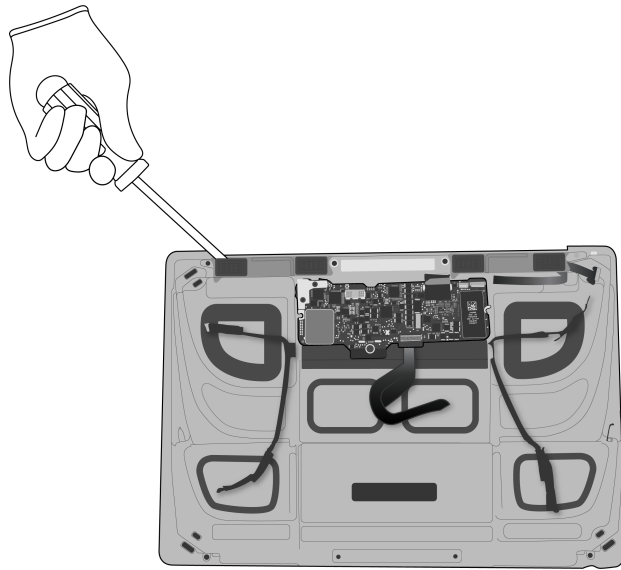

Tools Used



Fraction



Speakers

REE

Rare Earth
Elements

5. Pry off the main logic board.

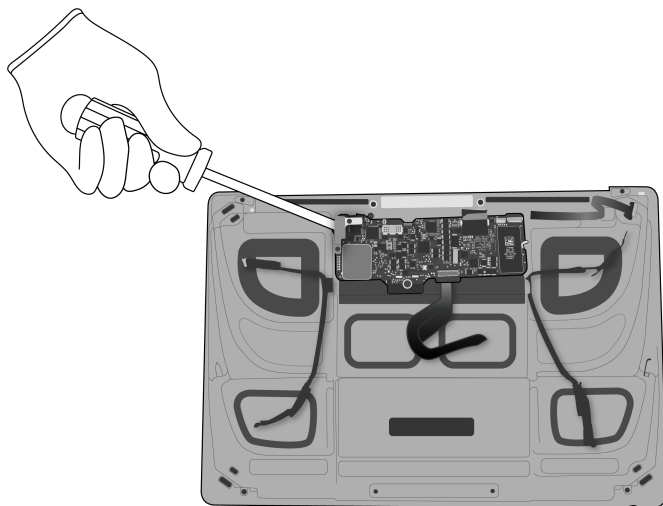

Tools Used



6. Pull off the ribbon cable.

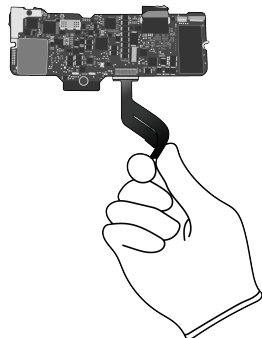

Fraction



Ribbon cable

Cu

Copper

Fraction



Main logic board

PMs

Precious Metals

7. Pry off the battery logic board.

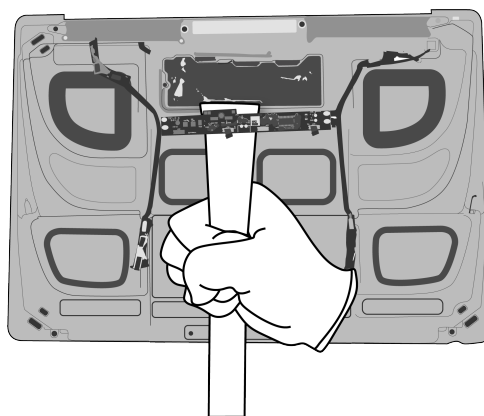

Tools Used



8. Cut off the battery cables on both sides.

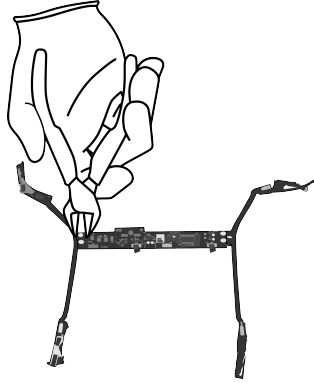

Tools Used



Fraction



Battery cables

Cu
Copper

Fraction



Battery logic board

PMs
Precious Metals

Fraction



Bottom case

Al
Aluminum

9. Separate the display from the top case.

» Unscrew the four Torx T8 fasteners from the hinges.

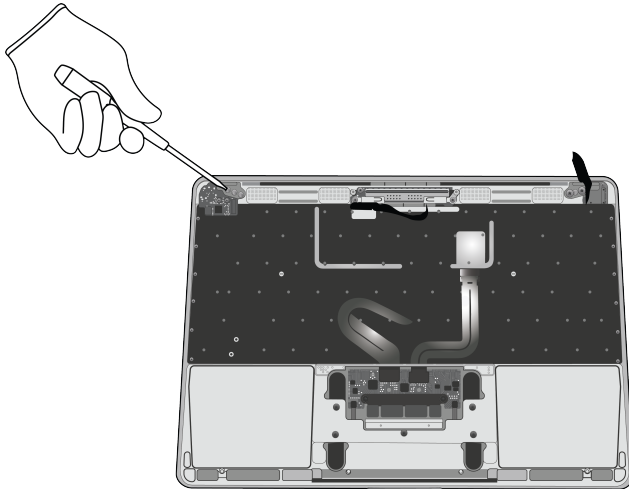

Tools Used

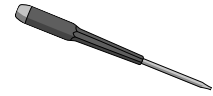

Fraction



Fasteners (x4)

Fe

Ferrous

» Unscrew the two Torx T5 fasteners from the top case logic board.

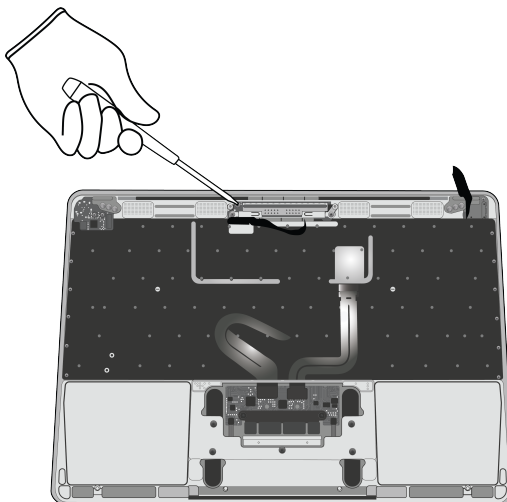

Tools Used

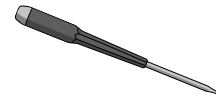

Fraction



Fasteners (x2)

Fe

Ferrous

» Pull the display away from the top case. Set the display aside.

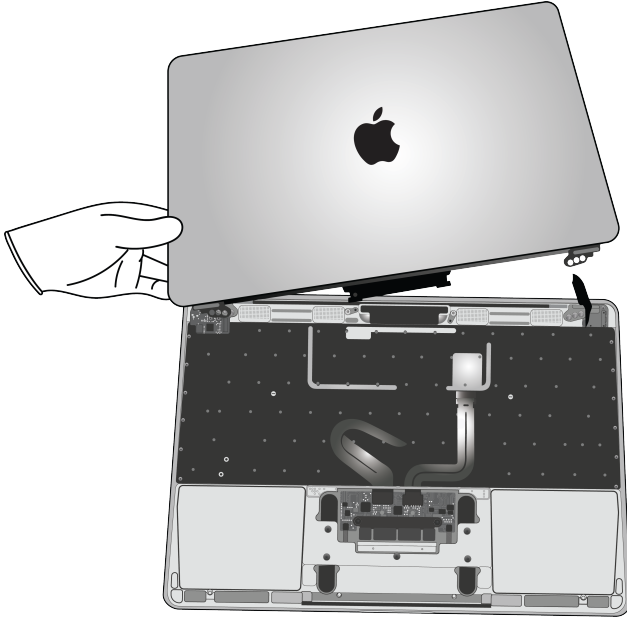

10. Remove the headphone jack logic board by unscrewing the two Torx T5 fasteners.

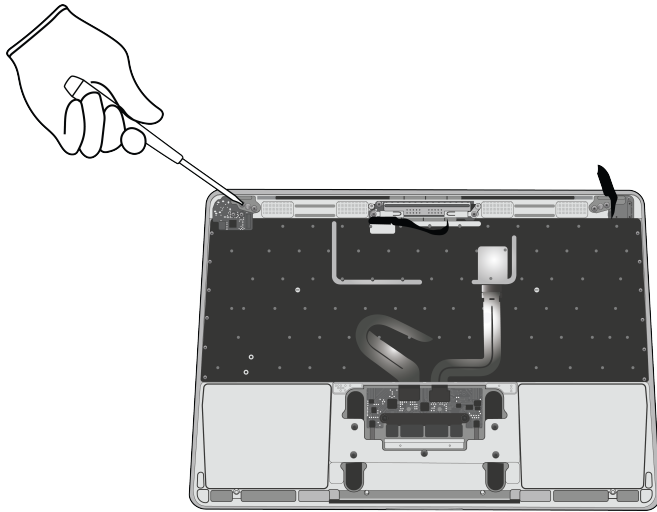

Tools Used

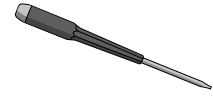

Fraction



Fasteners (x2)

Fe

Ferrous

Fraction

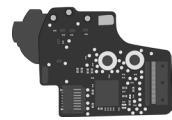

Headphone jack
logic board

PMs

Precious
Metals

11. Remove the USB-C logic board.

» Unscrew the two Torx T5 fasteners.

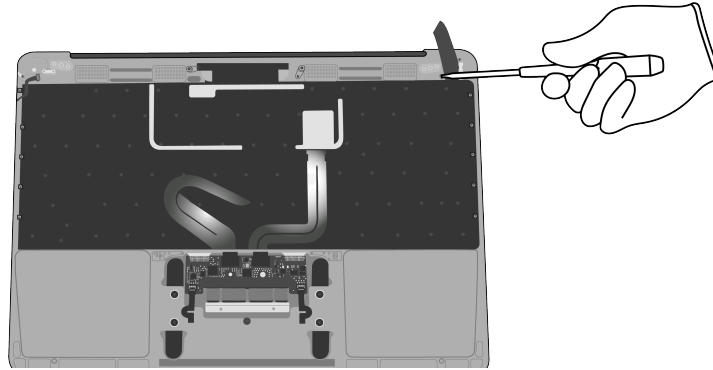

Tools Used

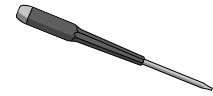

Fraction



Fasteners (x2)

Fe

Ferrous

» Pull off the ribbon cable.

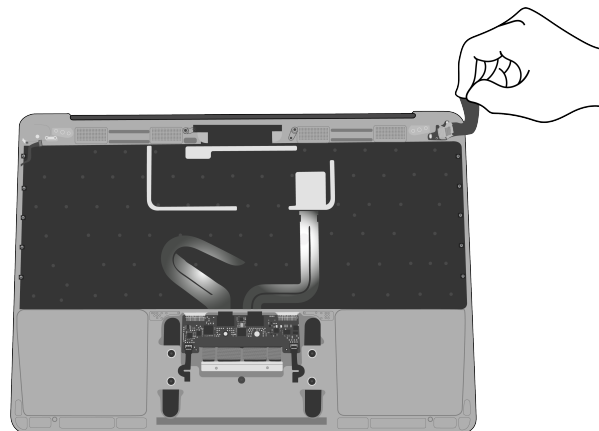

Fraction

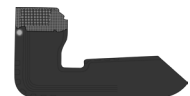

Ribbon cable

Cu

Copper

Fraction

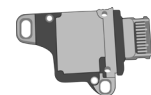

USB-C logic board

PMs

Precious Metals

12. Remove the trackpad.

» Unscrew the five Torx T3 fasteners.

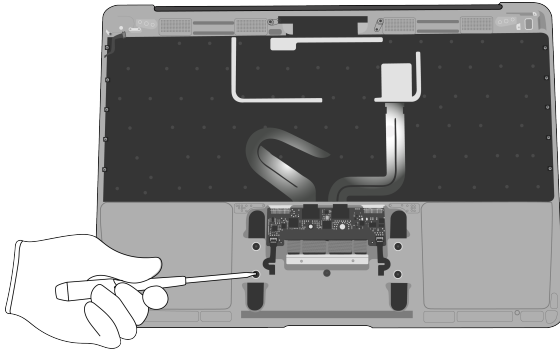

Tools Used

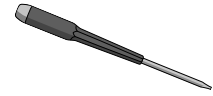

Fraction



Fasteners (x5)

Fe

Ferrous

» Pull the ribbon cables off the trackpad.

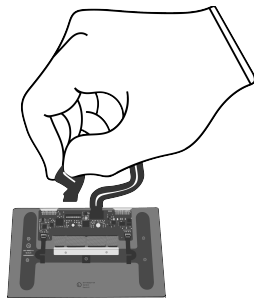

Fraction



Ribbon cables

Cu

Copper

Fraction



Trackpad

PMs

Precious Metals

- 13.** Separate the keyboard and trackpad enclosure by breaking the top case in half.

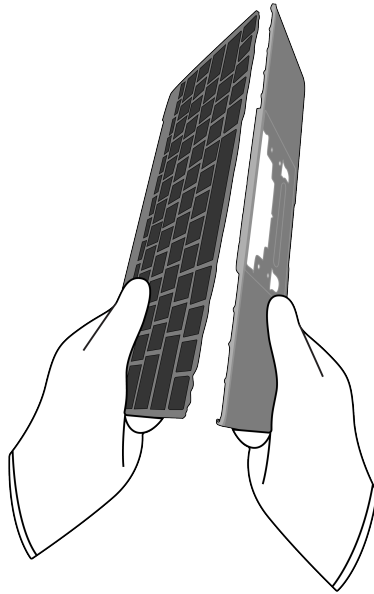
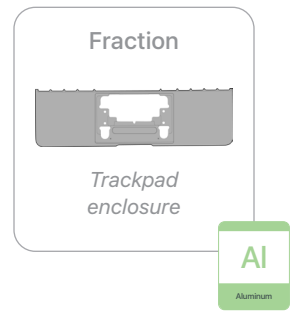
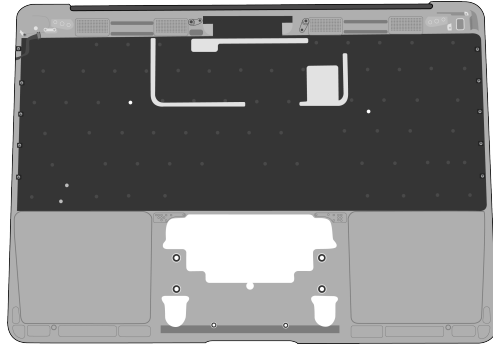

14. Remove the keyboard sheet from behind the keyboard.

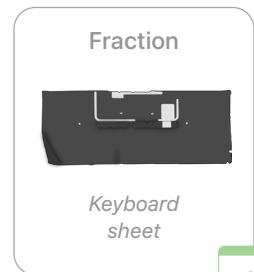
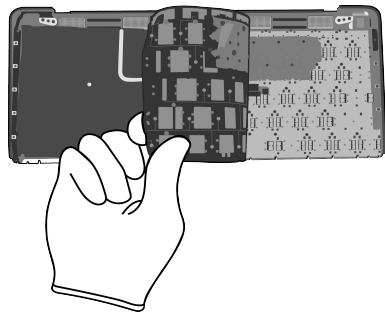

15. On the display, scrape off the display gasket.

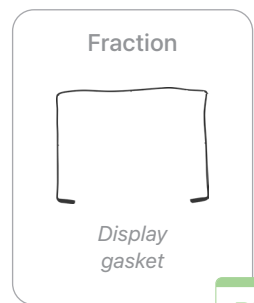
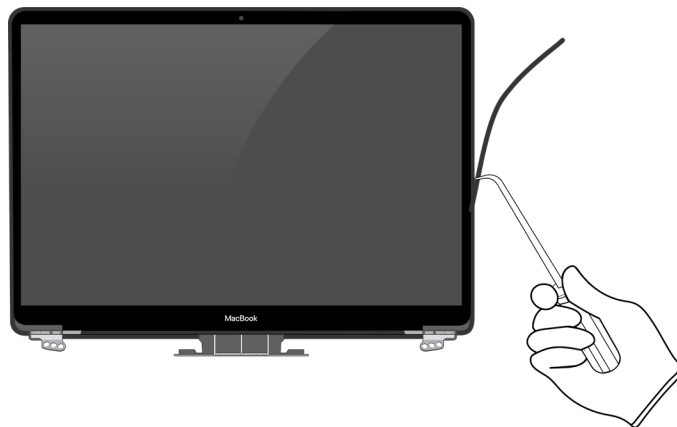
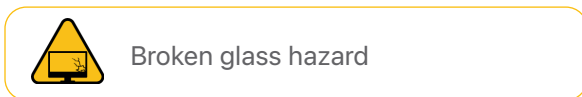

16. Pry the LCD cell and display films away from the display.

 Broken glass hazard

 Chemical exposure hazard

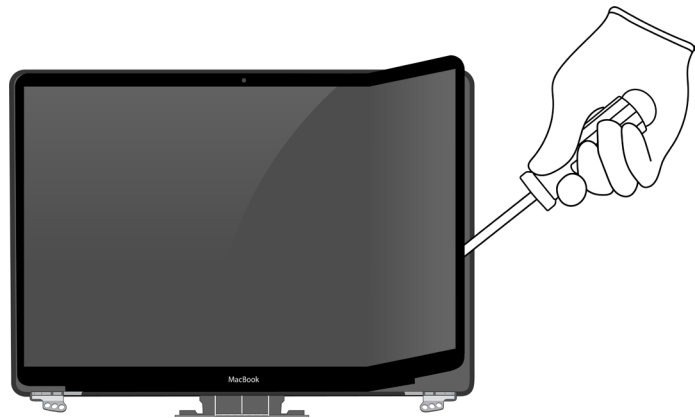

Tools Used



Fraction



Display films

PL
Plastics

Fraction



LCD cell

GL
Glass

17. Remove the camera with logic board.

» Unscrew the three Phillips fasteners.

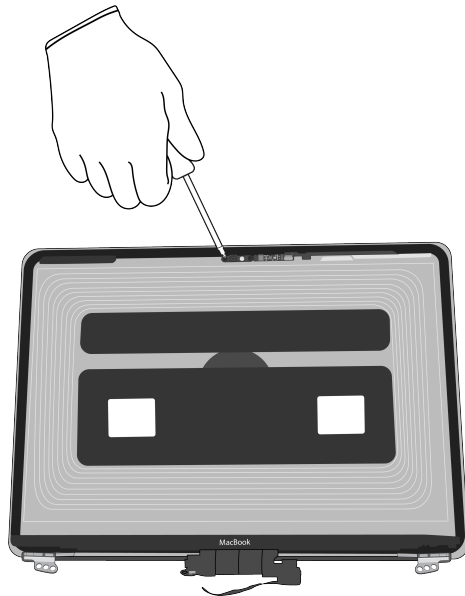

Tools Used

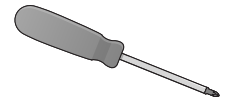

Fraction



Fasteners (x3)

Fe

Ferrous

» Pry off the camera with logic board.



Tools Used



Fraction



Camera with logic board

PMs

Precious Metals

18. Remove the data board assembly.

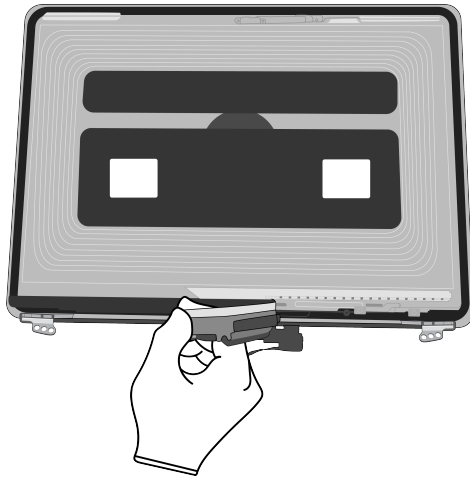

Fraction



Data board assembly

PMs

Precious Metals

19. Remove the LED logic board.



Chemical inhalation hazard

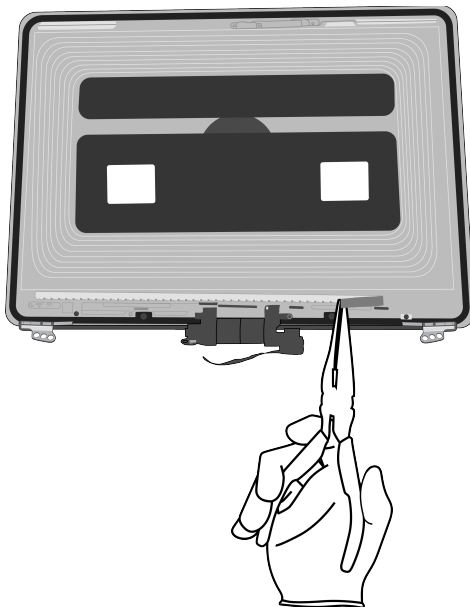

Tools Used



Fraction



LED logic board

PMs

Precious Metals

20. Remove the display logic board. Then pull off the ribbon cables.

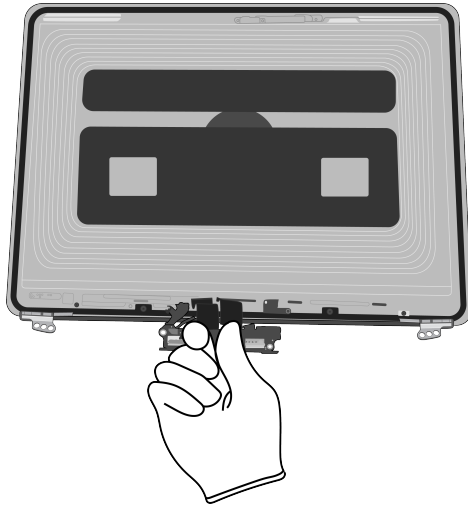

Fraction



Display logic board

PMs
Precious Metals

A diagram showing a rectangular display logic board. To its right is a green box containing the text "PMs" and "Precious Metals".

Fraction



Ribbon cables

Cu
Copper

A diagram showing several black ribbon cables. To its right is a green box containing the text "Cu" and "Copper".

21. Remove the magnets.

» Bend the display housing to pop up the four magnets.

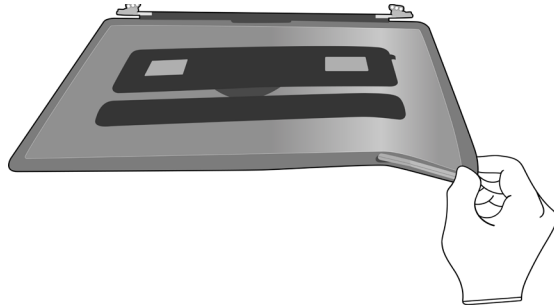

» Pry off the magnets.

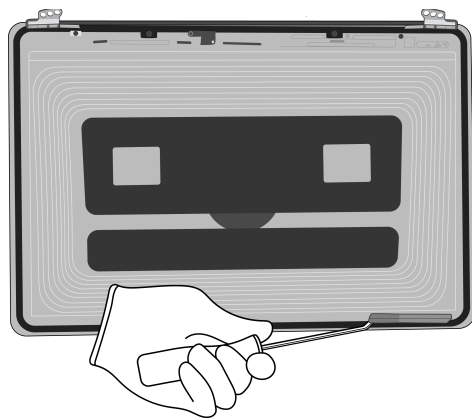

Tools Used



Fraction

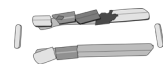

Magnets

REE
Rare Earth
Elements

Fraction









Display
housing

Al
Aluminum

Material Categorization of Output Fractions

All outputs from this process must be managed, handled, and disposed of in accordance with applicable waste laws and regulations, including but not limited to the Waste Framework Directive and its national enactments in Europe.

Fraction	Downstream Processing
<p>Aluminum</p>  <p><i>Bottom case</i></p>  <p><i>Trackpad enclosure</i></p>  <p><i>Keyboard sheet</i></p>  <p><i>Display housing</i></p>	<p>Primary Target Material</p>  <p>Potential Additional Materials</p> 

Fraction

Downstream Processing

Batteries



Lithium-ion polymer batteries

Primary Target Material



Ferrous



Fasteners (x18)

Primary Target Material



Glass



LCD cell

Primary Target Material



Potential Additional Materials



Fraction

Downstream Processing

Logic Boards



Main logic board



Battery logic board

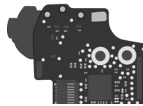

Headphone jack logic board



USB-C logic board

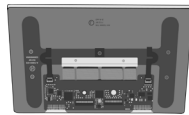

Trackpad



Keyboard

Primary Target Material



Potential Additional Materials



Logic Boards (cont.)



Camera with logic board



Data board assembly



LED logic board

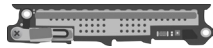

Display logic board

Mixed Electronics



Power adapter



Charge cable



Battery cables

Primary Target Material



Potential Additional Materials



Fraction

Downstream Processing

Mixed Electronics (cont.)

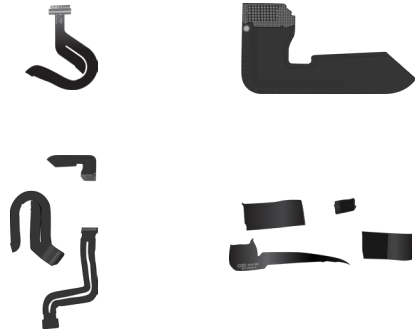

Ribbon cables

Mixed Plastics

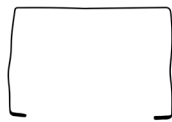

Display gasket



Display films

Primary Target Material



Rare Earth Magnets

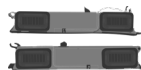

Speakers

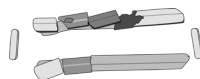

Magnets

Primary Target Material



Potential Additional Materials

