

HOMICIDE

IN CALIFORNIA 2006



Edmund G. Brown Jr., Attorney General
California Department of Justice
Division of California Justice Information Services
Bureau of Criminal Information and Analysis
CRIMINAL JUSTICE STATISTICS CENTER

HOMICIDE

IN CALIFORNIA

2006



Printed Annually by the
California Department of Justice
Division of California Justice Information Services
Bureau of Criminal Information and Analysis
CRIMINAL JUSTICE STATISTICS CENTER

Released August 2008

An electronic version of this report and other reports are available on the
California Attorney General's website: <http://ag.ca.gov>

CALIFORNIA DEPARTMENT OF JUSTICE

Edmund G. Brown Jr., Attorney General

DIVISION OF CALIFORNIA JUSTICE INFORMATION SERVICES

Gary Cooper, Director

BUREAU OF CRIMINAL INFORMATION AND ANALYSIS

Julie Basco, Bureau Chief

Marilyn Yankee, Assistant Bureau Chief

HOMICIDE IN CALIFORNIA, 2006

Umash Prasad, Principal Analyst

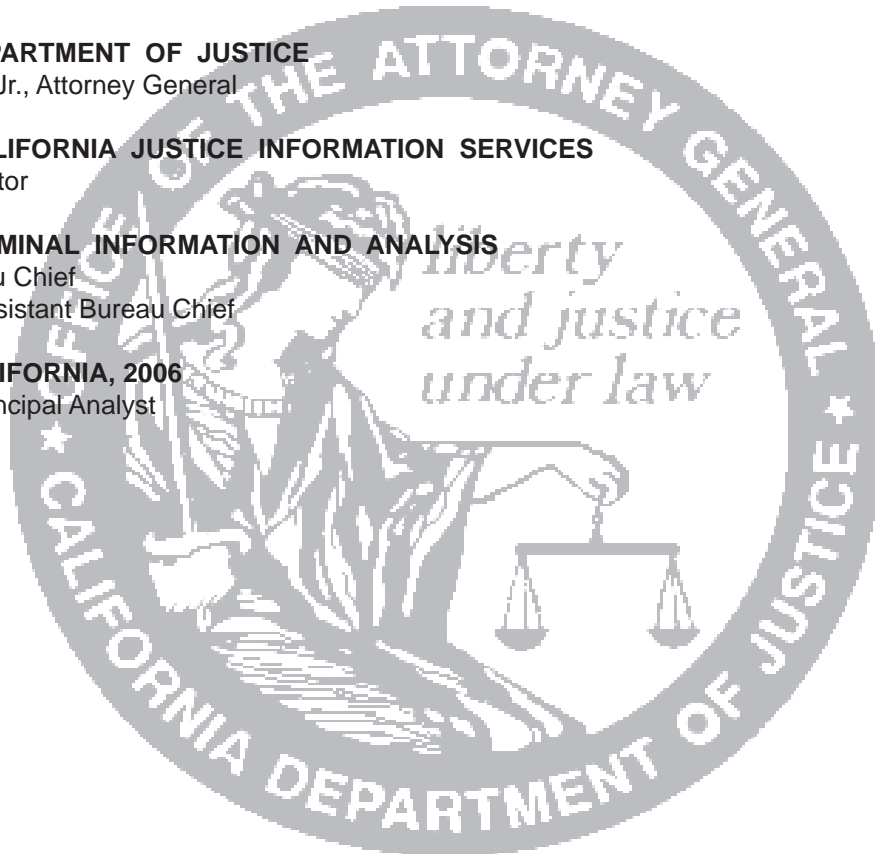

The role of the Criminal Justice Statistics Center is to:

- Collect, analyze, and report statistical data which provide valid measures of crime and the criminal justice process.*
- Examine these data on an ongoing basis to better describe crime and the criminal justice system.*
- Promote the responsible presentation and use of crime statistics.*

CONTENTS

Introduction..... iv

Highlights..... v

Homicide Overview Chart, 2006..... vi

Data Analysis..... 2

 Homicide Crimes..... 2

 Homicide Arrests..... 26

 Death Penalty Sentences 32

 Peace Officers Killed in the Line of Duty..... 36

 Justifiable Homicides 40

Data Tables 46

Appendices..... 89

 1 Computational Formulas..... 89

 2 Criminal Justice Glossary 90

INTRODUCTION

Homicide in California, 2006 contains information about the crime of homicide and its victims, as well as demographic data on persons arrested for homicide. Information about the death penalty, the number of peace officers killed in the line of duty, and justifiable homicide is also included.

Information displayed in this publication is extracted from several databases maintained by the California Department of Justice (DOJ). The primary source of information is the Homicide File, which captures willful and justifiable homicide crime data. Other databases capture information about persons arrested for homicide, death penalty sentences, and peace officers killed in the line of duty. The reader should consider that the type of data collected, and the methods used to collect these data, differ for each data set. *Unless otherwise indicated, all calculations are based on the number of known incidents.*

To provide the most valid data possible, the disposition section of this report has been removed. In 2001, Criminal Justice Statistics Center (CJSC) staff determined that a number of homicide arrests submitted to the DOJ's Automated Criminal History System (from which adult felony arrest disposition data are extracted) between 1997 and 2001 should have been submitted as arrests for attempted homicide. In addition, some correctly submitted attempted homicide arrests were programmatically treated as homicide arrests. As a result, more homicide arrests were counted during these years than occurred. This caused a lower percentage

of homicide convictions and a higher percentage of assault convictions. (Both percentages were based on the number of adult felony arrests for homicide for which dispositions were received.) Based on CJSC staff findings, the reader is advised against using previously published disposition data from 1997 to 1999. It should be noted that the DOJ has addressed this issue and that the exclusion of disposition data does not affect crime, arrest, death penalty, nor other data included in this or past reports. When homicide disposition data are once again determined to be accurate, they will be included in this publication.

Since 2004, the population estimates used to calculate rates were based on revisions of the 2000 census. Prior to 2003, these population estimates were based on revisions of the 1990 census. Readers are advised to exercise care in interpreting changes in percent and rates between decennial census samples, as these census samples are statistically independent and measure two different populations at two different points in time. In addition, the "Other" population category now includes the new race/ethnic group of "Multi-racial." The extent to which this new race/ethnic group affects other population estimates is unknown at this time.

CJSC publications, available in either printed or electronic format (via the Attorney General's website), are listed on the inside of the back cover. Customized statistical reports or additional statistical information may be requested by contacting the CJSC at the numbers or addresses provided.

HIGHLIGHTS

HOMICIDE CRIMES *(see pages 2–23)*

- ❑ From 1997 to 2006, the homicide crime rate decreased 15.4 percent (7.8 to 6.6). From 2005 to 2006, homicide crimes decreased 2.9 percent in rate per 100,000 population (6.8 to 6.6). (Source: Table 1.)
- ❑ A greater percentage of white victims were female than were Hispanic or black victims. White victims tended to be older, Hispanic and black victims, younger. (Source: Tables 8 and 9.)
- ❑ In 2006, where the victim-offender relationship was known, 43.2 percent of the victims were killed by friends or acquaintances. (Source: Table 12.)
- ❑ Of the 35 counties for which 2006 homicide rates were calculated, Tulare County experienced the highest rate per 100,000 population (11.5); Marin County experienced the lowest (1.2). (Source: Table 14.)
- ❑ In 2006, the highest average daily number of homicides occurred on weekends. (Source: Table 16.)
- ❑ In 2006, where the contributing circumstance was known, 38.7 percent of homicides were the result of an argument. (Source: Table 24.)

HOMICIDE ARRESTS *(see pages 26–29)*

- ❑ From 1997 to 2006, the homicide arrest rate decreased 22.1 percent (8.6 to 6.7). From 2005 to 2006, homicide arrests decreased 1.5 percent in rate per 100,000 population at risk (6.8 to 6.7). (Source: Table 29.)
- ❑ From 1997 to 2006, the overwhelming majority of homicide arrestees and victims were male. (Source: Tables 5 and 30.)

- ❑ From 1997 to 2006, the largest percentage of homicide arrestees and victims were Hispanic. (Source: Tables 6 and 31.)
- ❑ From 1997 to 2006, the largest percentage of homicide arrestees and victims were aged 18–29. (Source: Tables 7 and 32.)

DEATH PENALTY SENTENCES

(see pages 32–33)

- ❑ By the end of 2006, there were 665 persons under sentence of death in California. Of these, 17 were sentenced in 2006. (Source: Table 35.)

PEACE OFFICERS KILLED IN THE LINE OF DUTY *(see pages 36–37)*

- ❑ Between 1997 and 2006, there were 50 peace officers feloniously killed in the line of duty. Five were killed in 2006. (Source: Table 37.)
- ❑ Between 1997 and 2006, the homicide rate for peace officers killed in the line of duty varied from 2.9 to 10.7 per 100,000 sworn law enforcement personnel. (Source: Table 37.)

JUSTIFIABLE HOMICIDES *(see pages 40–43)*

- ❑ In 2006, justifiable homicides by peace officers were most often the result of a felon attacking a peace officer (91.1 percent). (Source: Table 41.)

Figure 1
HOMICIDE IN CALIFORNIA, 2006
Overview

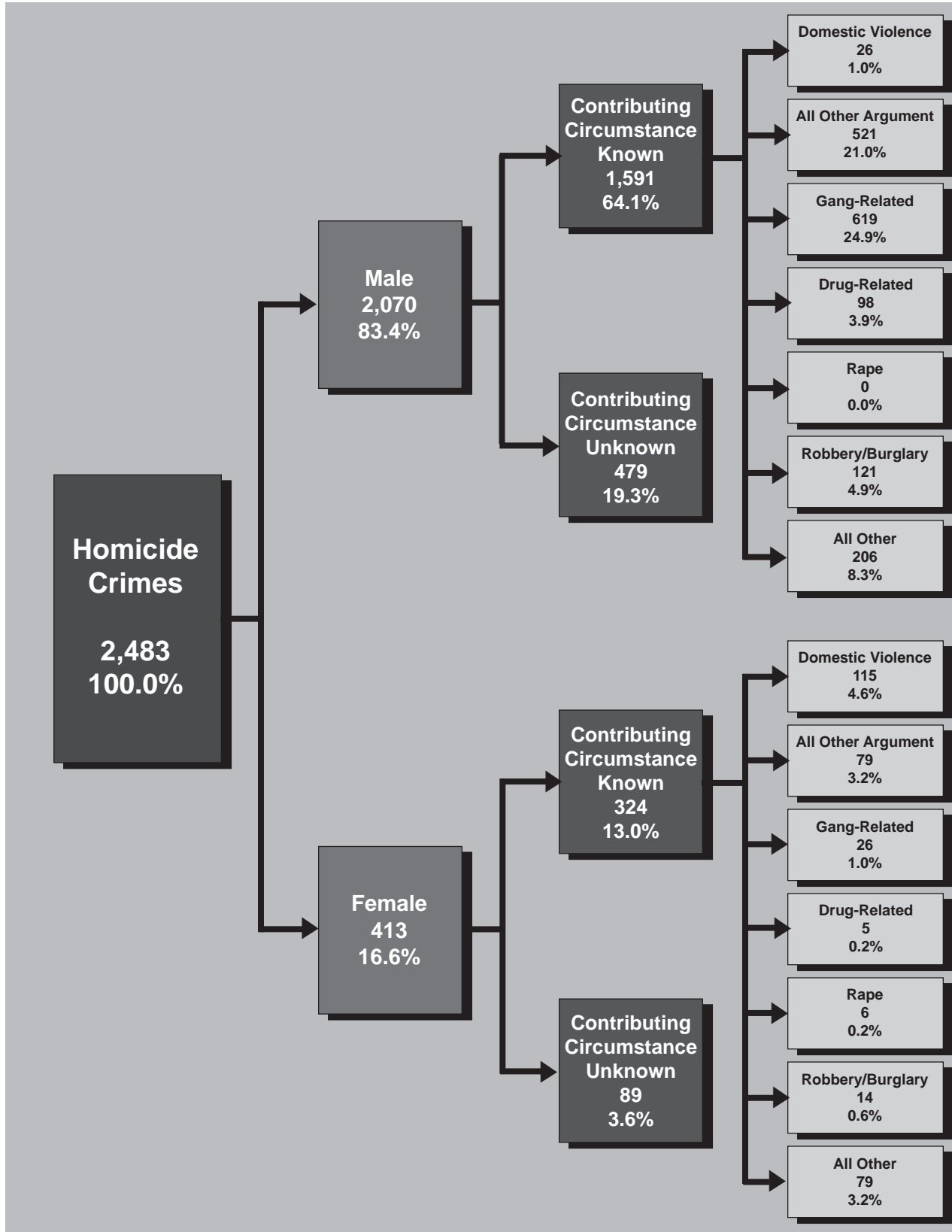

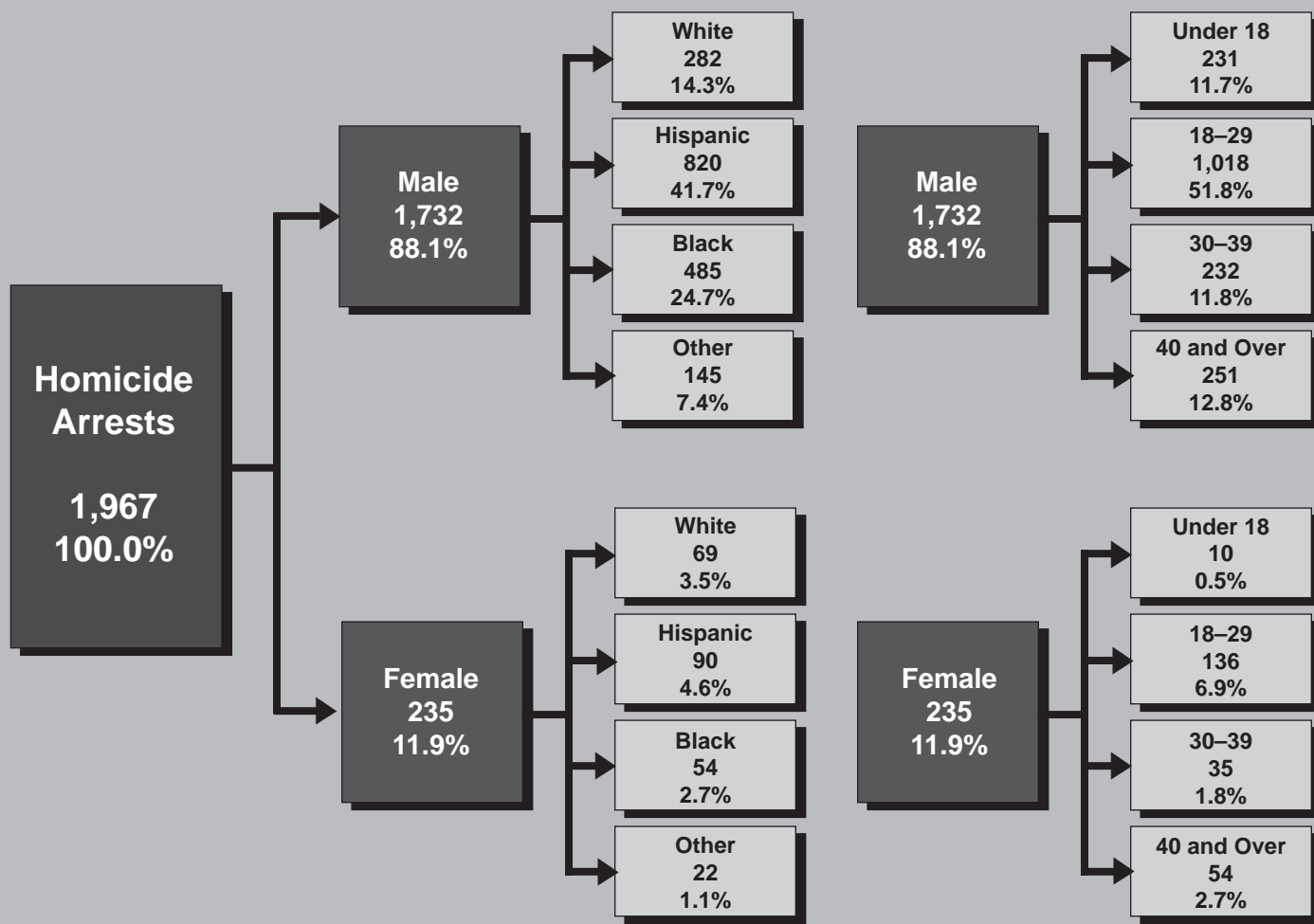

Source: Tables 25 and 34.

Notes: Percentages may not add to subtotals or 100.0 because of rounding.

Contributing circumstance percent calculations in this figure are based on the total number of victims, rather than on the number of known circumstances. Therefore, percentages displayed here will not match percentages displayed elsewhere in this report.

CRIMES

The homicide category comprises murder and non-negligent manslaughter. Attempted murder, justifiable homicide, manslaughter by negligence, and suicide are excluded.

CONTRIBUTING CIRCUMSTANCE

Contributing circumstance, when known, is reported by law enforcement agencies on the supplemental homicide report. In 2006, there were 568 homicides in

which the contributing circumstance was unknown. Of this number, 479 involved male victims and 89 involved female victims.

ARRESTS

All California law enforcement agencies report arrest information to the DOJ on the *Monthly Arrest and Citation Register*. Data submitted includes age, gender, and race/ethnic group; and specifies the most serious arrest offense and law enforcement disposition.

***HOMICIDE
CRIMES***



HOMICIDE CRIMES

Homicide is defined by the FBI's Uniform Crime Reporting (UCR) Program as the "willful (non-negligent) killing of one human being by another." The homicide category comprises murder and nonnegligent manslaughter. Attempted murder, justifiable homicide, manslaughter by negligence, and suicide are excluded. Data depicting homicide in California have been collected and published for 55 years.

From 2005 to 2006:

- The homicide rate per 100,000 population decreased 2.9 percent (6.8 to 6.6).
- The number of homicides decreased 0.8 percent (from 2,503 to 2,483).

Comparing 1997 to 2006:

- The homicide rate per 100,000 population decreased 15.4 percent (7.8 to 6.6).
- The number of homicides decreased 3.7 percent (from 2,579 to 2,483).

In 2006, the number of homicides decreased 0.8 percent, while the rate per 100,000 decreased 2.9 percent.

Table N-1
HOMICIDE CRIMES, 1952-2006
Number and Rate per 100,000 Population

Year(s)	Number	Rate
2006	2,483	6.6
2005	2,503	6.8
2004	2,394	6.5
2003	2,402	6.7
2002	2,392	6.8
2001	2,201	6.3
2000	2,074	6.0
1999	2,006	5.9
1998	2,170	6.5
1997	2,579	7.8
1996	2,910	9.0
1995	3,530	11.0
1994	3,699	11.5
1993	4,095	12.9
1992	3,920	12.5
1991	3,876	12.6
1990	3,562	12.1
1989	3,159	11.0
1988	2,947	10.5
1987	2,929	10.7
1986	3,030	11.3
1985	2,781	10.7
1984	2,724	10.6
1983	2,640	10.5
1982	2,778	11.3
1981	3,140	13.1
1980	3,405	14.4
1979	2,941	12.6
1978	2,601	11.4
1977	2,481	11.1
1976	2,214	10.1
1975	2,196	10.2
1974	1,970	9.3
1973	1,862	8.9
1972	1,789	8.7
1971	1,633	8.0
1970	1,355	6.8
1969	1,376	6.9
1968	1,171	6.0
1967	1,051	5.4
1966	897	4.7
1965	892	4.8
1964	758	4.2
1963	656	3.7
1962	671	3.9
1961	609	3.7
1960	620	3.9
1959	515	3.4
1958	547	3.7
1957	497	3.5
1956	474	3.5
1955	417	3.2
1954	419	3.3
1953	276	2.3
1952	279	2.4

Figure 2
VIOLENT CRIMES, 1997–2006
Rate per 100,000 Population

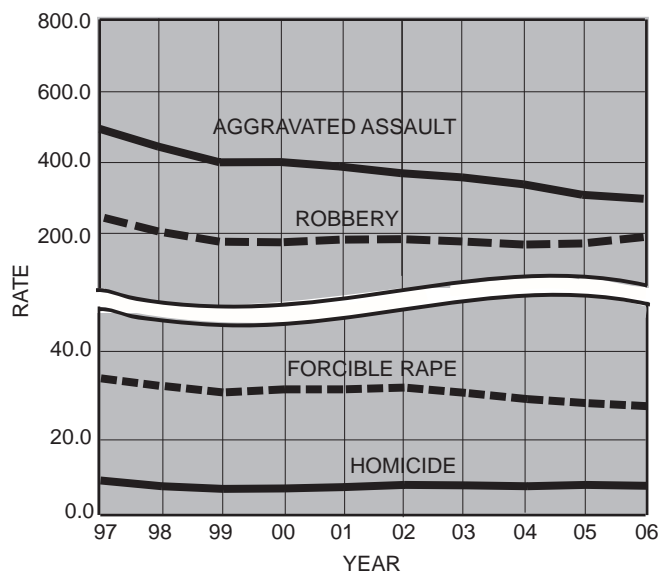

Source: Table 1.

There are four offenses classified as violent crimes by the FBI: *homicide, forcible rape, robbery, and aggravated assault*. For comparison, changes in the rates of the four offenses follow:

From 2005 to 2006:

- Homicide decreased 2.9 percent (6.8 to 6.6).
- Forcible rape decreased 2.8 percent (25.3 to 24.6).
- Robbery increased 10.6 percent (171.4 to 189.5).
- Aggravated assault decreased 3.6 percent (308.9 to 297.7).

Comparing 1997 to 2006:

- Homicide decreased 15.4 percent (7.8 to 6.6).
- Forcible rape decreased 20.4 percent (30.9 to 24.6).
- Robbery decreased 23.3 percent (247.0 to 189.5).
- Aggravated assault decreased 39.9 percent (495.3 to 297.7).



Figures 3, 4, and 5 display homicide rates per 100,000 population for victims classified by gender, race/ethnic group, and age.

In 2006,

- The total homicide rate was 6.6 per 100,000 population.
- The male homicide rate was over 5.0 times that of the female homicide rate (11.1 vs. 2.2).
- The black homicide rate was almost 11 times that of whites and over 3 times that of Hispanics (29.5 vs. 2.7 and 8.3, respectively).

Comparing 1997 to 2006:

- The male homicide rate decreased 9.0 percent and the female homicide rate decreased 21.4 percent.
- The white homicide rate decreased 12.9 percent, the Hispanic homicide rate decreased 25.2 percent, and the black homicide rate was the same.

Between 1997 and 2006, homicide rates declined considerably for both males and females (down 9.0 and 21.4 percent, respectively). The homicide rate for blacks declined for the second year in a row after being on a general increase since 2000.

Figure 3
HOMICIDE CRIMES, 1997–2006
By Gender of Victim
Rate per 100,000 Population

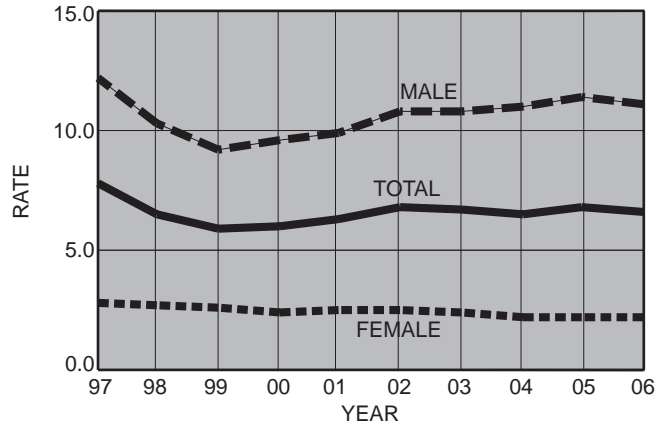

Source: Table 2.

Figure 4
HOMICIDE CRIMES, 1997–2006
By Race/Ethnic Group of Victim
Rate per 100,000 Population

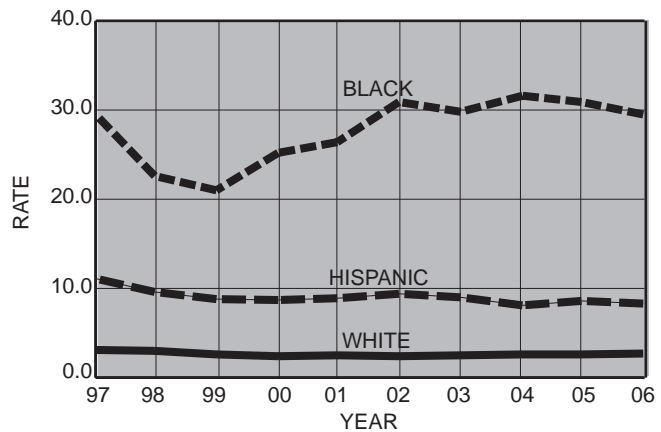

Source: Table 3.

Figure 5
 HOMICIDE CRIMES, 1997–2006
 By Age of Victim
 Rate per 100,000 Population

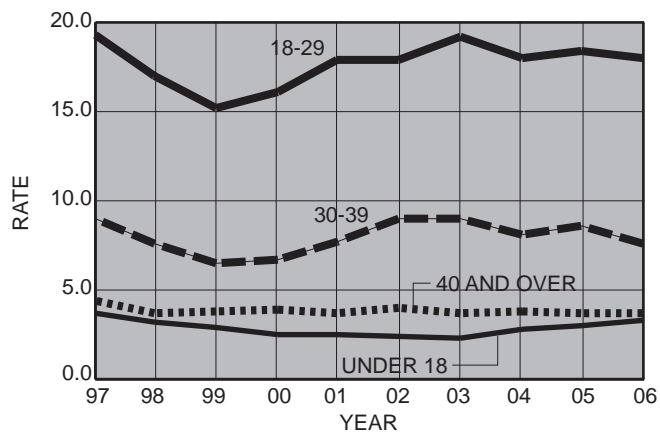

Source: Table 4.

In 2006,

- Persons aged 18–29 had the highest homicide victimization rate (18.0 per 100,000 population).

Comparing 1997 to 2006, the homicide rate:

- Decreased 10.8 percent for victims under age 18.
- Decreased 6.7 percent for victims aged 18–29.
- Decreased 15.6 percent for victims aged 30–39.
- Decreased 15.9 percent for victims aged 40 and over.

The homicide rate for victims aged 18–29 has consistently been the highest of any age group.

In 2006,

- ☐ Males represented 83.4 percent of total homicide victims; they comprised 49.9 percent of the population.
- ☐ Females represented 16.6 percent of total homicide victims; they comprised 50.1 percent of the population.

Figure 6
HOMICIDE CRIMES, 2006
By Gender of Victim

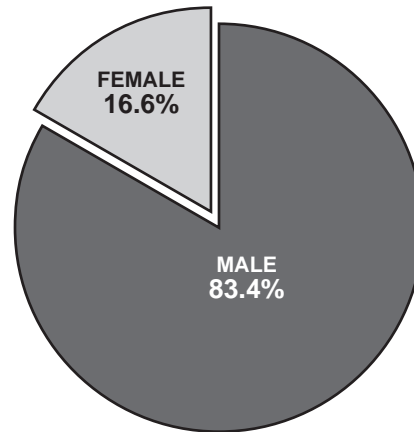

Source: Table 5.

Figure 7
HOMICIDE CRIMES, 2006
Gender of Victim by Percent of Total Victims and Percent of Population

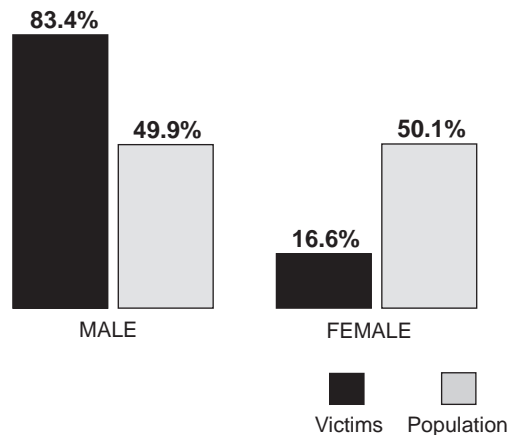

Source: Tables 2 and 5.

The ratio of male to female homicide victimization has been approximately 4:1. This ratio represents a consistent historical trend (see Tables 2 and 5).

Figure 8
HOMICIDE CRIMES, 2006
By Race/Ethnic Group of Victim

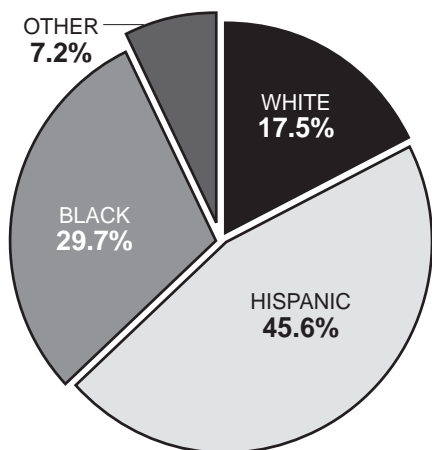

Source: Table 6.

In 2006, where the victim's race was known:

- Whites represented 17.5 percent of the homicide victims; they comprised 42.2 percent of the population.
- Hispanics represented 45.6 percent of the homicide victims; they comprised 36.4 percent of the population.
- Blacks represented 29.7 percent of the homicide victims; they comprised 6.7 percent of the population.
- The "other" race/ethnic group category represented 7.2 percent of the homicide victims; they comprised 14.7 percent of the population.

Figure 9
HOMICIDE CRIMES, 2006
Race/Ethnic Group of Victim by Percent of Total Victims
and Percent of Population

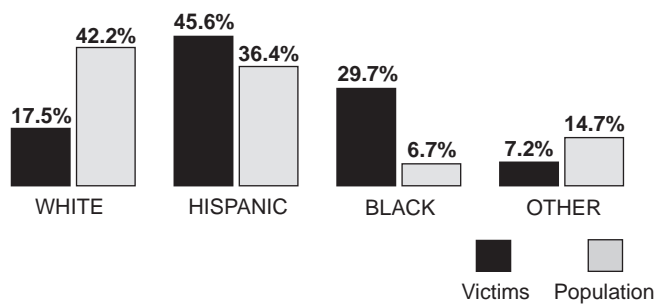

Source: Tables 3 and 6.



In 2006, where the victim's age was known:

- 12.8 percent of the homicide victims were under age 18; this age group comprised 25.9 percent of the population.
- 46.5 percent of the homicide victims were aged 18–29; this age group comprised 17.1 percent of the population.
- 16.9 percent of the homicide victims were aged 30–39; this age group comprised 14.8 percent of the population.
- 23.8 percent of the homicide victims were aged 40 and over; this age group comprised 42.3 percent of the population.

Figure 10
HOMICIDE CRIMES, 2006
By Age of Victim

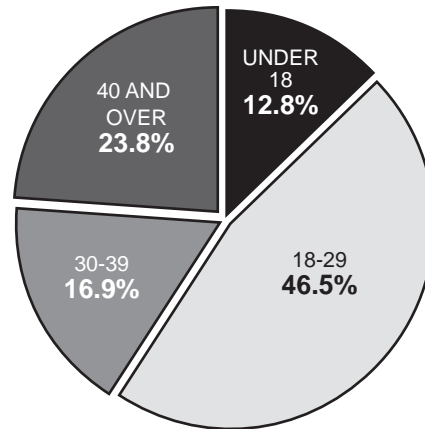

Source: Table 7.

Figure 11
HOMICIDE CRIMES, 2006
Age of Victim by Percent of Total Victims and Percent of Population

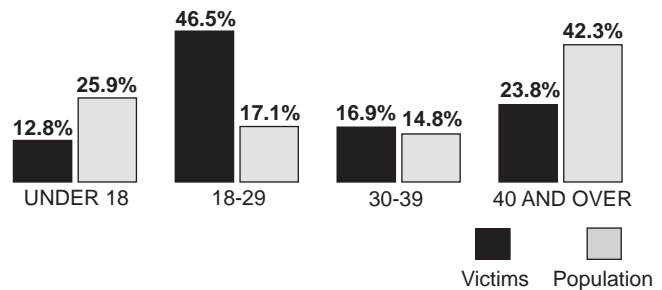

Source: Tables 4 and 7.
Note: Percentages may not add to 100.0 because of rounding.

Where the age of the victim was known, victims aged 18–29 have accounted for over 40 percent of the homicides (see Table 7).

Figure 12
HOMICIDE CRIMES, 2006
Race/Ethnic Group of Victim by Gender of Victim

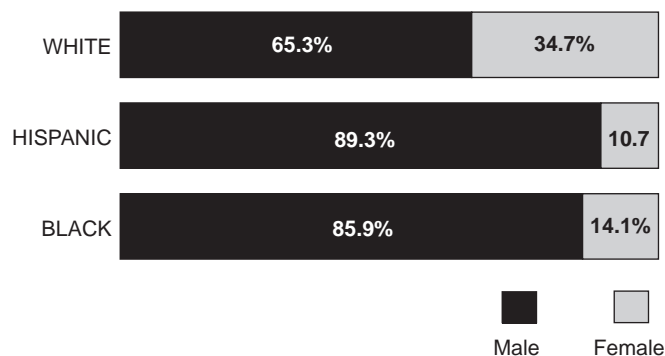

Source: Table 8.

Figure 13
HOMICIDE CRIMES, 2006
Race/Ethnic Group of Victim by Age of Victim

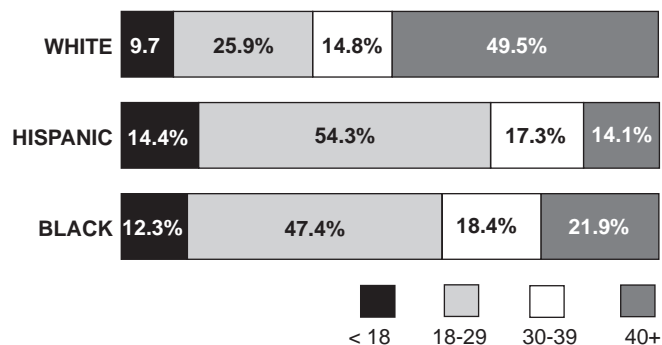

Source: Table 9.

Note: Percentages may not add to 100.0 because of rounding.

In 2006,

- A greater percentage of white victims were female than were either Hispanic or black victims (34.7 vs. 10.7 and 14.1 percent, respectively).
- A greater percentage of Hispanic and black victims were aged 18–29 than were white victims (54.3 and 47.4 vs. 25.9 percent, respectively).
- A greater percentage of white victims were aged 40 and over than were either Hispanic or black victims (49.5 vs. 14.1 and 21.9 percent, respectively).

In 2006, females constituted a higher percentage of white victims than of Hispanic or black victims. White victims tended to be older, while Hispanic and black victims tended to be younger.

In 2006, when homicides were examined by the relationship of the victim to the offender, it was found that:

- 43.2 percent of victims were friends or acquaintances of offenders.
- 6.3 percent of victims were spouses of offenders.
- 6.8 percent of victims were parents or children of offenders.
- 3.1 percent of the relationships of victim to offender fell into the "other relative" category.
- 40.6 percent of victims were strangers to offenders.

Comparing 1997 to 2006:

- The proportion of homicides in which victims were friends or acquaintances of offenders decreased from 50.5 percent to 43.2 percent.
- The proportion of homicides in which victims were strangers to offenders increased from 35.0 percent to 40.6 percent.

In 2006, where the victim/offender relationship was known, 43.2 percent of the victims were killed by a friend or acquaintance.

Figure 14
HOMICIDE CRIMES, 2006
By Relationship of Victim to Offender

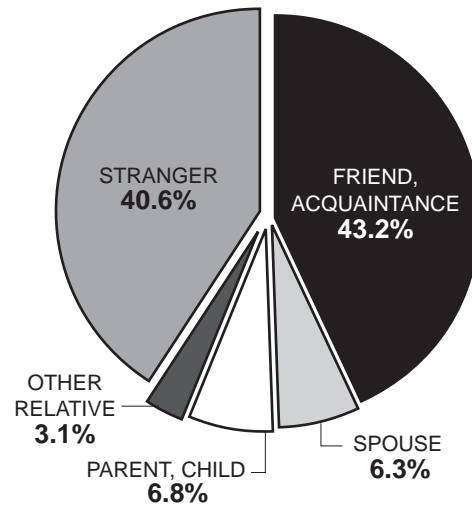

Source: Table 11.

Figure 15
HOMICIDE CRIMES, 1997–2006
By Selected Relationships of Victims to Offenders

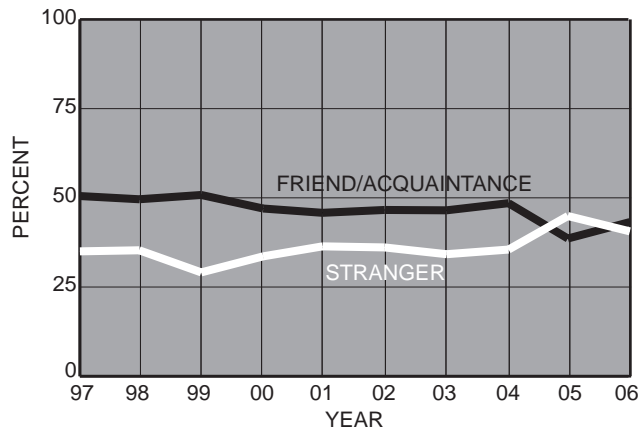

Source: Table 11.

Figure 16
HOMICIDE CRIMES, 2006
Gender of Victim by Relationship of Victim to Offender

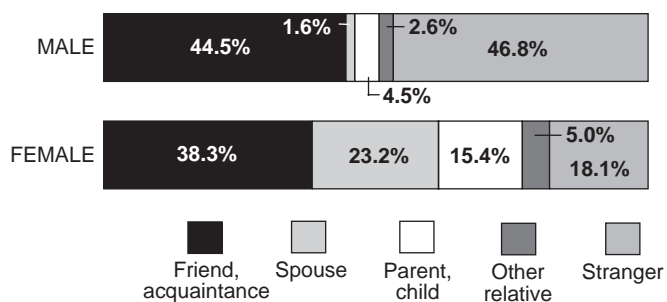

Source: Table 12.

In 2006,

- A greater percentage of female victims were spouses of offenders (23.2 percent) than were male victims (1.6 percent).
- A greater percentage of Hispanic and black victims were strangers to offenders than were white victims (45.5 and 37.0 vs. 32.7 percent, respectively).

Figure 17
HOMICIDE CRIMES, 2006
Race/Ethnic Group of Victim by Relationship of Victim to Offender

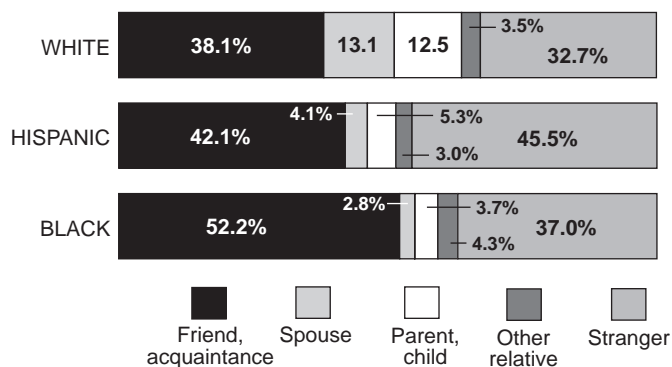

Source: Table 12.

Note: Percentages may not add to 100.0 because of rounding.



In 2006,

- ❑ Victims under 18, 30–39, and 40 and over were most likely friends or acquaintances of the offenders (41.2, 44.8, and 41.1 percent, respectively).
- ❑ A greater percentage of victims aged 40 and over were spouses of the offenders (13.9 percent) than were victims in any other age group shown.

Figure 18
HOMICIDE CRIMES, 2006
Age of Victim by Relationship of Victim to Offender

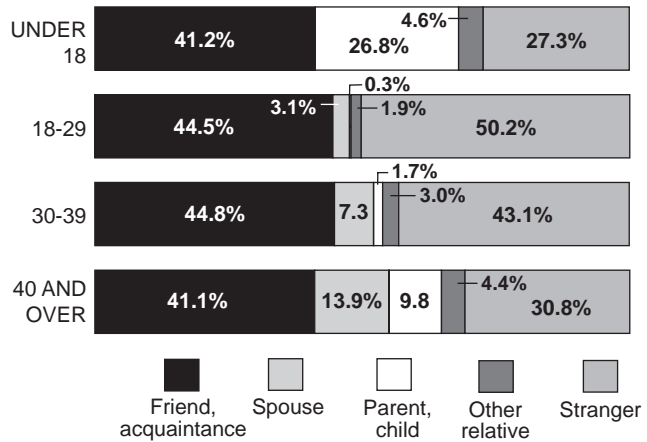

Source: Table 13.
Note: Percentages may not add to 100.0 because of rounding.

In 2006, 26.8 percent of homicide victims under age 18 were children of the offenders. Over 50 percent of homicide victims aged 18–29 were strangers to the offenders.

Figure 19
 HOMICIDE CRIMES, 2006
 County by Rate per 100,000 Population

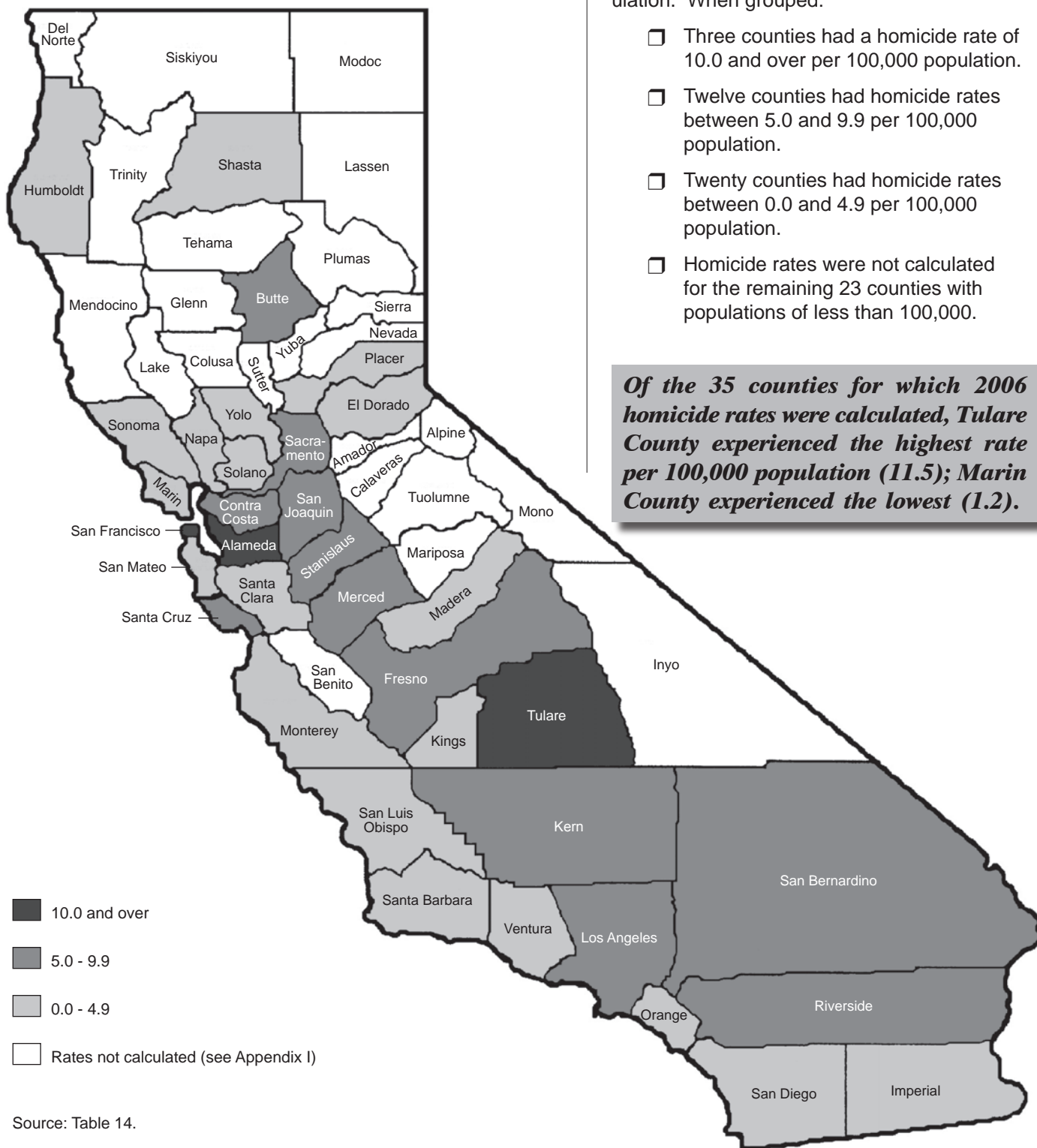



In 2006, when homicides were examined by season of incident, it was found that:

- ☐ The incidents leading to death occurred more often in the summer than in any other season (27.5 percent).

Figure 20
HOMICIDE CRIMES, 2006
By Season of Incident

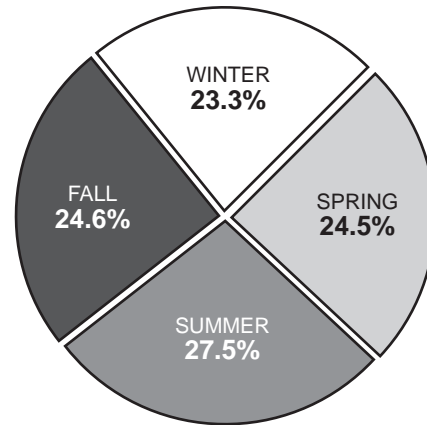

Source: Table 15.
Note: Percentages do not add to 100.0 because of rounding.

Figure 21
HOMICIDE CRIMES, 1997–2006
By Season of Incident

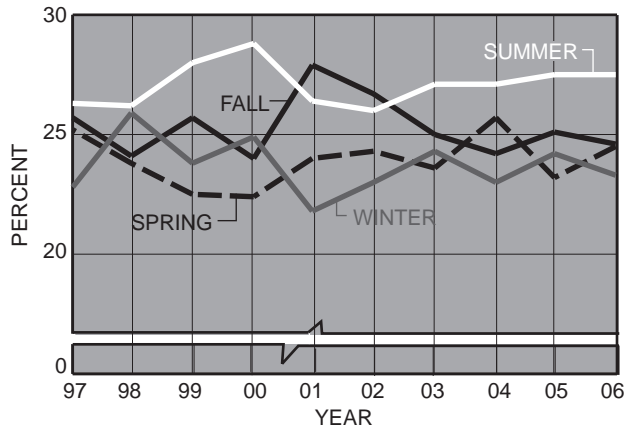

Source: Table 15.

From 1997 to 2006, the average number of homicides committed during the summer exceeded the average number committed during any other season (see Table 15).

Figure 22
HOMICIDE CRIMES, 2006
Race/Ethnic Group of Victim by Average Daily Number
of Incidents on Weekdays and Weekends

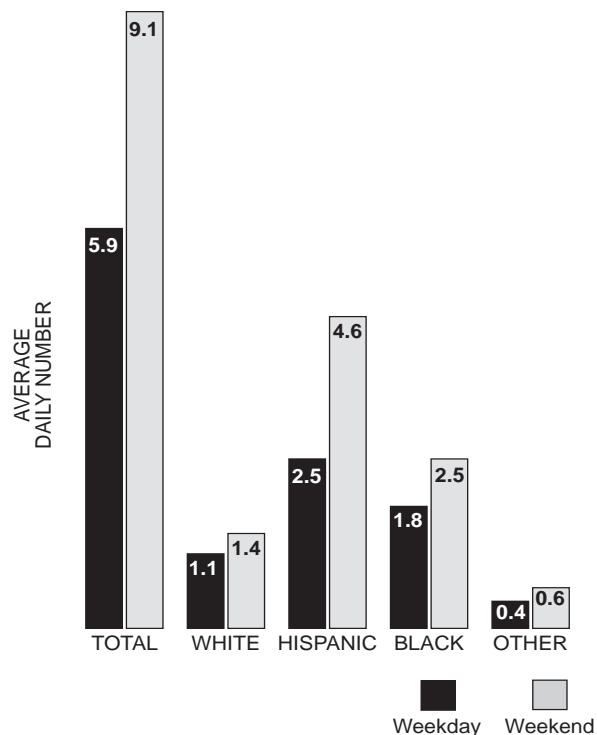

Source: Table 16.

Figure 23
HOMICIDE CRIMES, 2006
Age of Victim by Average Daily Number
of Incidents on Weekdays and Weekends

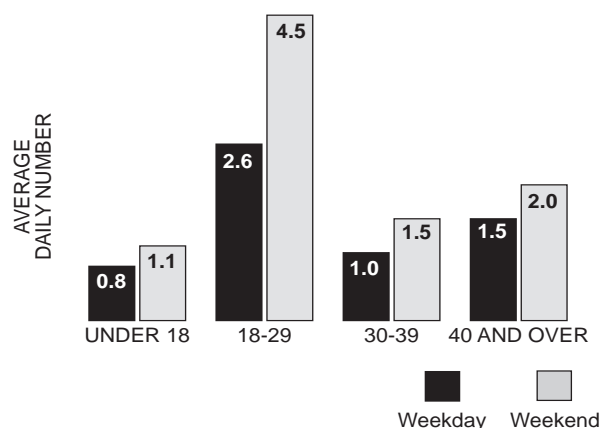

Source: Table 17.

In 2006, when homicides were examined by day of incident, it was found that:

- An average of 5.9 homicide victims were killed each weekday and 9.1 homicide victims were killed each weekend day.
- Hispanic victims had the highest average daily number of incidents on both weekdays and weekends (2.5 and 4.6, respectively) of any race/ethnic group shown.
- Victims aged 18–29 had the highest average daily number of incidents on both weekdays and weekends (2.6 and 4.5, respectively) of any age group shown.

Regardless of race/ethnic group or age, the highest average number of homicides occurred on weekends.



In 2006, when homicides were examined by location of incident, it was found that:

- 22.2 percent of victims were killed at their places of residence.
- 44.5 percent of homicides occurred on streets or sidewalks.
- 33.2 percent of homicides occurred in “all other” locations.
- The greatest percentage of males (49.1 percent) were killed on streets or sidewalks.
- The majority of females (51.2 percent) were killed at their places of residence.

Figure 24
HOMICIDE CRIMES, 2006
By Location of Homicide

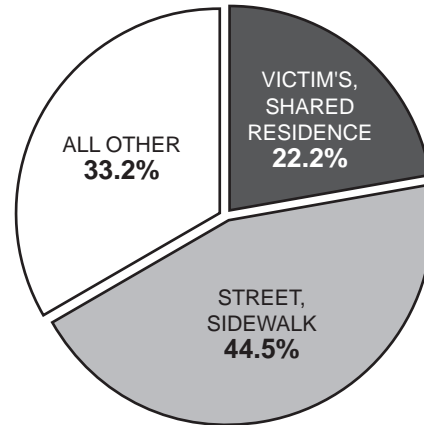

Source: Table 19.
Note: Percentages do not add to 100.0 because of rounding.

Figure 25
HOMICIDE CRIMES, 2006
Gender of Victim by Location of Homicide

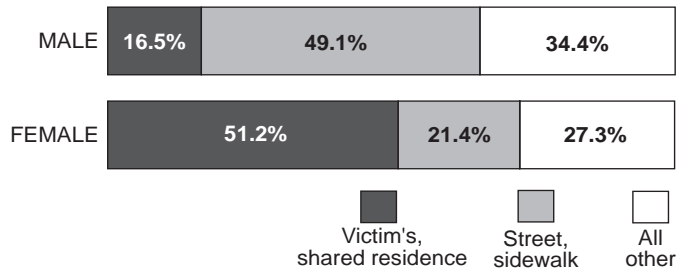

Source: Table 19.
Note: Percentages may not add to 100.0 because of rounding.

Females were more likely than males to be killed in their residence, while males were more likely to be killed on streets or sidewalks.

Figure 26
HOMICIDE CRIMES, 2006
Race/Ethnic Group of Victim by Location of Homicide

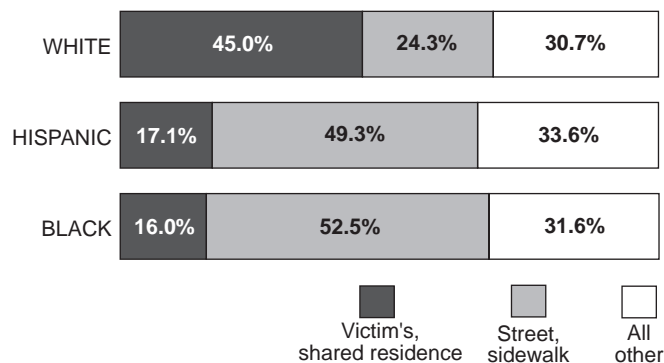

Source: Table 19.
Note: Percentages may not add to 100.0 because of rounding.

Figure 27
HOMICIDE CRIMES, 2006
Age of Victim by Location of Homicide

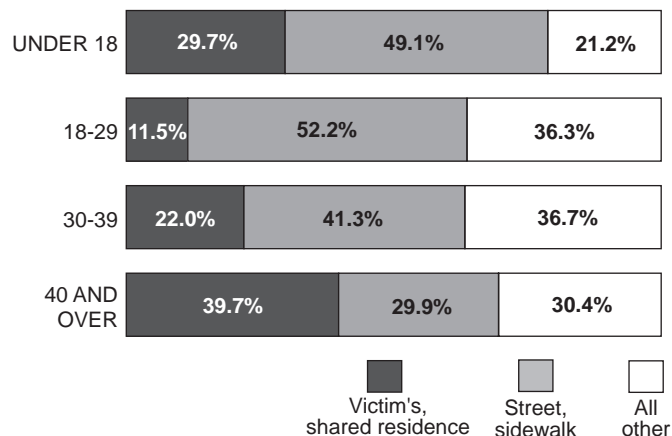

Source: Table 20.

In 2006,

- A greater percentage of whites than Hispanics or blacks were killed at their places of residence (45.0 vs. 17.1 and 16.0 percent, respectively).
- A greater percentage of Hispanics and blacks were killed on streets or sidewalks than were whites (49.3 and 52.5 vs. 24.3 percent, respectively).
- A greater percentage of victims aged 18–29 were killed on streets or sidewalks (52.2 percent) than were victims in any other age group shown.
- A greater percentage of victims aged 40 and over were killed at their places of residence (39.7 percent) than were victims in any other age group shown.

Victims aged 40 and over were killed most often in their residences, while victims in all other age groups were mostly killed on streets or sidewalks.

In 2006, when homicides were examined by type of weapon used, it was found that:

- ❑ 74.1 percent resulted from the use of firearms.
 - 65.9 percent resulted from the use of handguns.
 - 8.2 percent resulted from the use of all other types of firearms.
- ❑ 12.8 percent resulted from the use of knives.
- ❑ 5.3 percent resulted from the use of personal weapons (hands, feet, etc.).
- ❑ 3.1 percent resulted from the use of blunt objects (clubs, etc.).
- ❑ 4.7 percent resulted from the use of weapons grouped in the “all other” category.

Comparing 1997 to 2006:

- ❑ The proportion of homicides that resulted from the use of firearms increased slightly (from 72.3 percent to 74.1 percent).
- ❑ The proportion of homicides that resulted from the use of non-firearms decreased (from 27.7 percent to 25.9 percent).

Figure 28
HOMICIDE CRIMES, 2006
By Type of Weapon Used

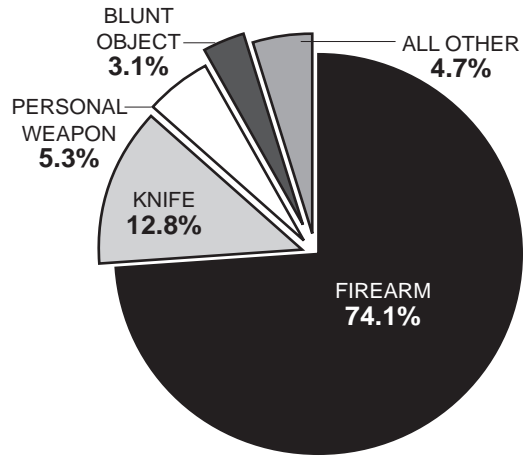

Source: Table 21.

Figure 29
HOMICIDE CRIMES, 1997–2006
By Selected Types of Weapons Used

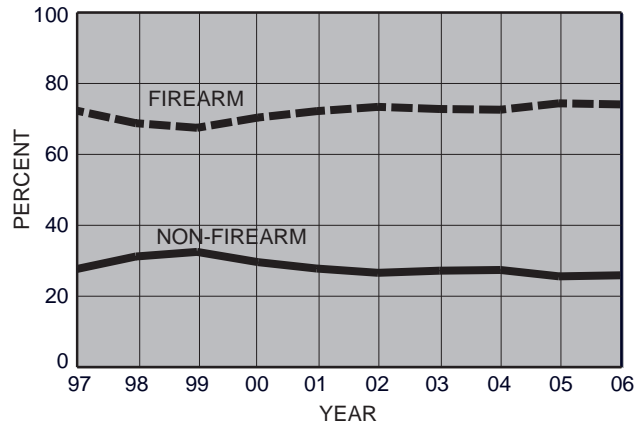

Source: Table 21.

Figure 30
HOMICIDE CRIMES, 2006
Gender of Victim by Type of Weapon Used

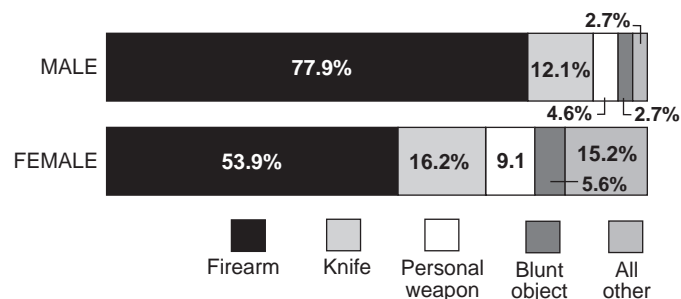

Source: Table 22.

In 2006,

- A greater percentage of males (77.9 percent) were killed with firearms than were females (53.9 percent).
- A greater percentage of females (46.1 percent) were killed with non-firearms than were males (22.1 percent).
- A greater percentage of Hispanics and blacks were killed with firearms than were whites (76.9 and 85.1 vs. 46.9 percent, respectively).

Figure 31
HOMICIDE CRIMES, 2006
Race/Ethnic Group of Victim by Type of Weapon Used

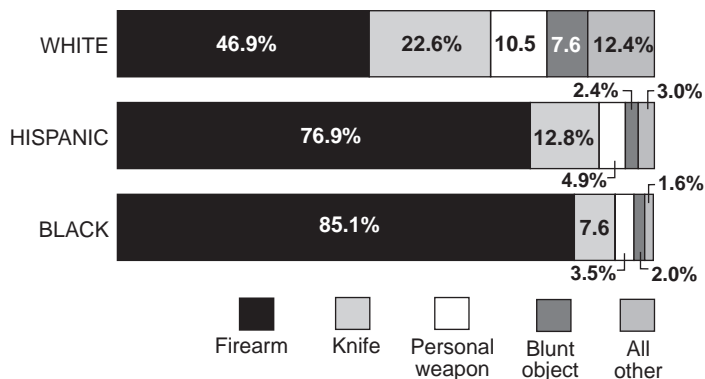

Source: Table 22.

Note: Percentages may not add to 100.0 because of rounding.

In 2006, for victims of the race/ethnic groups shown, a higher percentage were killed by a firearm than by any other type of weapon.



In 2006,

- ☐ A greater percentage of victims aged 18–29 were killed with firearms (84.9 percent) than were victims in any other age group shown.

Figure 32
HOMICIDE CRIMES, 2006
Age of Victim by Type of Weapon Used

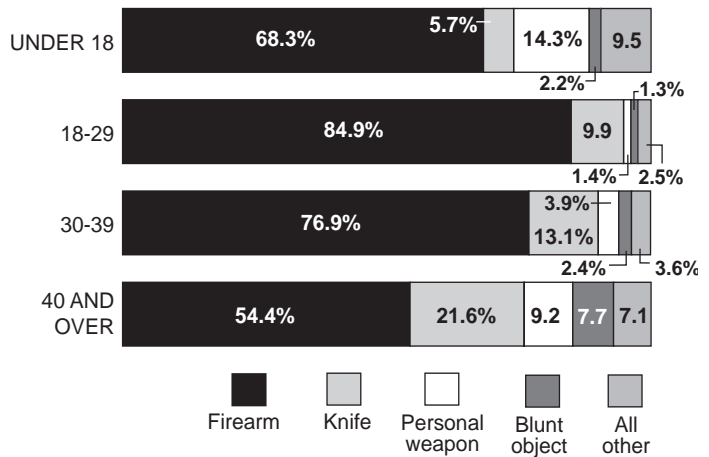

Source: Table 23.
Note: Percentages may not add to 100.0 because of rounding.

In 2006, over half of the homicide victims in each category were killed with a firearm.

Figure 33
HOMICIDE CRIMES, 2006
By Contributing Circumstance

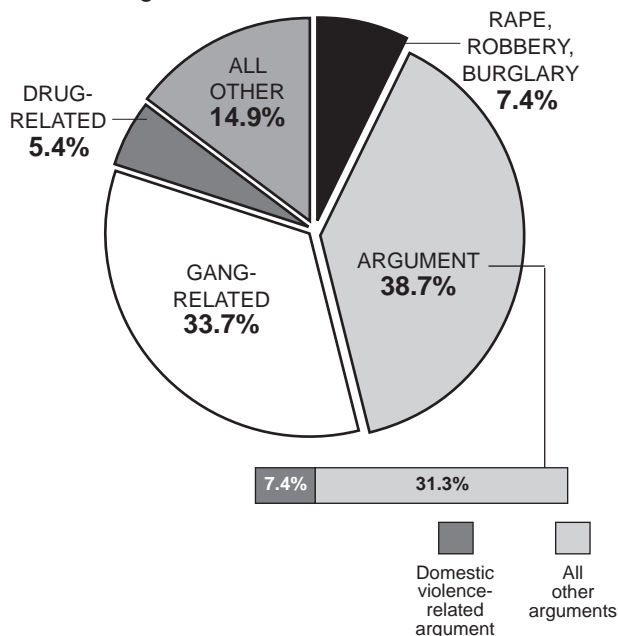

Source: Table 24.
Note: Percentages do not add to 100.0 because of rounding.

Figure 34
HOMICIDE CRIMES, 1997–2006
By Selected Contributing Circumstance

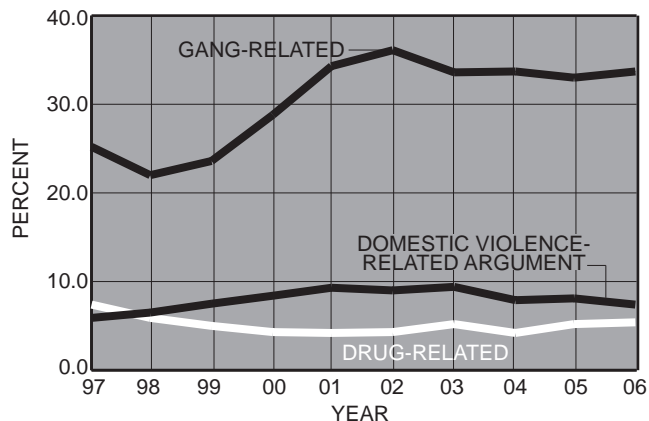

Source: Table 24.

In 2006, when homicides were examined by contributing circumstance, it was found that:

- 7.4 percent occurred as a result of a rape, robbery, or burglary.
- 38.7 percent occurred as a result of an argument.
 - 7.4 percent occurred as a result of a domestic violence-related argument.
 - 31.3 percent occurred as a result of all other types of arguments.
- 33.7 percent were gang-related.
- 5.4 percent were drug-related.
- 14.9 percent occurred as a result of “all other” contributing circumstances.

Comparing 1997 to 2006:

- The percentage of homicides in which the contributing circumstance was a domestic violence-related argument increased from 5.9 percent to 7.4 percent.
- The percentage of homicides in which the contributing circumstance was gang-related increased from 25.2 percent to 33.7 percent.
- The percentage of homicides in which the contributing circumstance was drug-related decreased from 7.4 percent to 5.4 percent.

From 1997 to 2006, the number of gang-related homicides increased by 18.6 percent.



In 2006,

- Males (38.9 percent) were victims of gang-related homicides more than any other contributing circumstance.
- Females (35.5 percent) were victims of domestic violence-related homicides more than any other contributing circumstance.

In 2006,

- The proportion of gang-related homicides was much greater for Hispanics and blacks than for whites (43.8, 33.8, and 11.2 percent, respectively).

Figure 35
HOMICIDE CRIMES, 2006
Gender of Victim by Contributing Circumstance

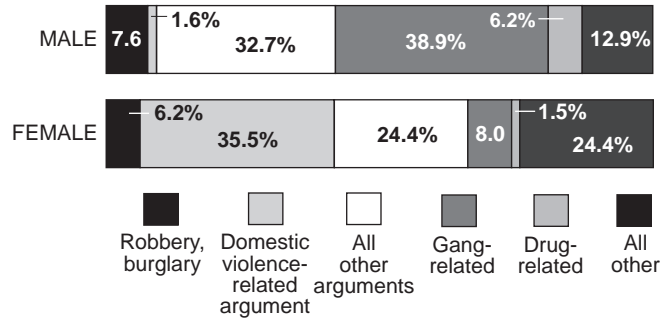

Source: Table 25.
Notes: Percentages may not add to 100.0 because of rounding. Figures 33, 36, and 37 include rape with robbery and burglary. However, for a more relevant comparison between male and female victims, rape is included in the "all other" category in Figure 35. In 2006, 1.9 percent of homicide crimes involving females were rape-related.

Figure 36
HOMICIDE CRIMES, 2006
Race/Ethnic Group of Victim by Contributing Circumstance

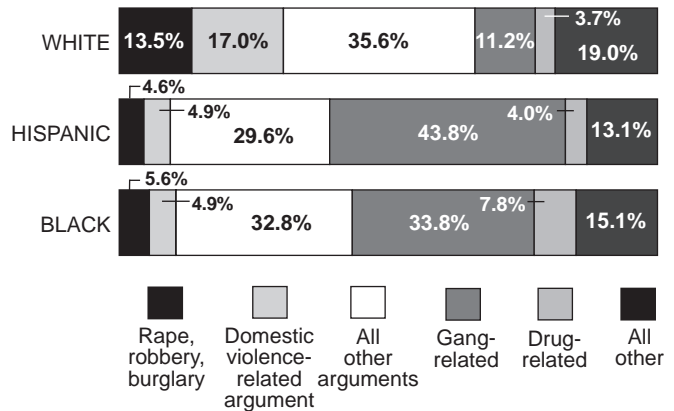

Source: Table 25.
Note: Percentages may not add to 100.0 because of rounding.

Figure 37
HOMICIDE CRIMES, 2006
Age of Victim by Contributing Circumstance

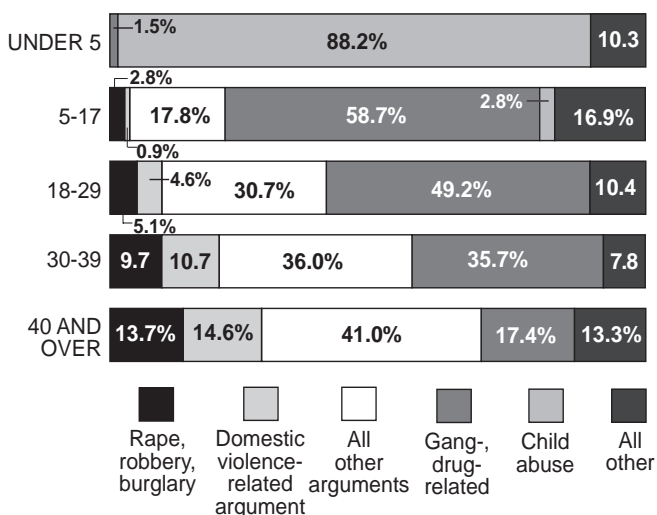

Source: Table 26.
Note: Percentages may not add to 100.0 because of rounding.

Figure 38
HOMICIDE CRIMES CLEARED, 1997–2006
Clearance Rate

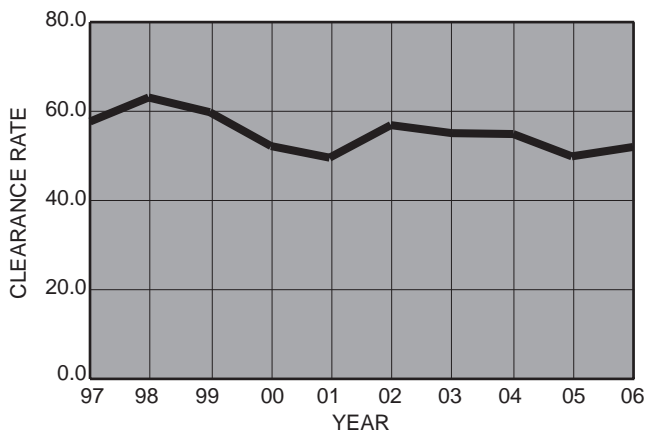

Source: Table 28.
Note: A clearance rate is the percentage of crimes (homicides) reported that have been cleared. It is calculated by dividing the number of homicides cleared by the number of homicides reported. The result is multiplied by 100. Please see “Appendix II – Criminal Justice Glossary” for a detailed explanation of clearances.

In 2006, where the contributing circumstance was known:

- The majority of homicide victims under age 5 were killed as a result of child abuse (88.2 percent).
- The greatest percentage of homicide victims aged 5–17 and aged 18–29 were killed as a result of gang-related or drug-related activities (58.7 and 49.2 percent, respectively).
- The greatest percentage of homicide victims aged 30–39 and aged 40 and over were killed as a result of argument-related conflicts (46.7 and 55.6 percent, respectively).

From 1997 to 2006:

- Homicide clearance rates fell from 57.7 to 52.0.
- Clearance rates ranged from a high of 63.1 in 1998 to a low of 49.6 in 2001.

The proportion of persons over five killed as the result of gang- and drug-related circumstances decreased with age. Conversely, the proportion killed as the result of an argument increased with age.

***HOMICIDE
ARRESTS***

HOMICIDE ARRESTS

Unlike crimes, which are classified by nationwide Uniform Crime Reporting (UCR) standards, arrests are reported by the statutory definition of the offense.¹ This may cause some differences in the definitions of certain crimes and the reporting of the arrests for those crimes. For instance, the California definition of a homicide arrest includes murder and *nonvehicular* manslaughter. The federal definition of a homicide crime includes murder and *nonnegligent* (nonaccidental) manslaughter.

All California law enforcement agencies report arrest and citation information to the DOJ on the “Monthly Arrest and Citation Register.” This register lists each arrestee; includes information about age, gender, and race/ethnic group; and specifies the “most serious” arrest offense and law enforcement disposition.

In 2006, of the 1,967 arrests for homicide:

- 88.1 percent (1,732) of arrestees were male.
- 11.9 percent (235) of arrestees were female.

In 2006, nearly 9 out of 10 homicide arrestees were male (88.1 percent).

¹ The following penal codes for homicide arrest offenses were valid at the time of the closeout of the 2006 arrest offense code file: 128, 187(a), 189, 192(a), 192(b), 193(a), 193(b), 273ab, 399, and 12310(a).

Figure 39
HOMICIDE ARRESTS, 2006
By Gender of Arrestee
Figure 41

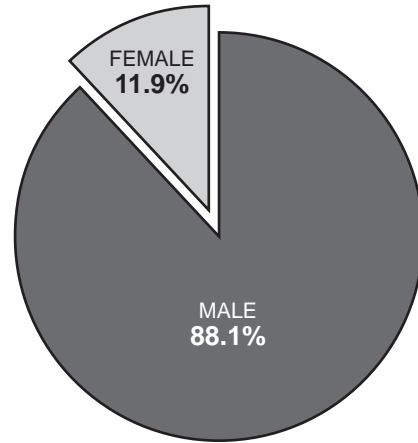

Source: Table 30.

Figure 40
POPULATION IN CALIFORNIA, 2006
By Gender

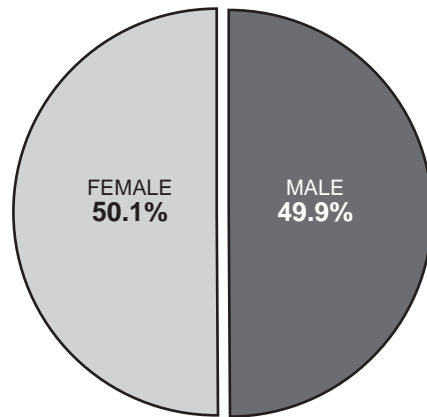

Source: Table 2.

Figure 41
HOMICIDE ARRESTS, 2006
By Race/Ethnic Group of Arrestee

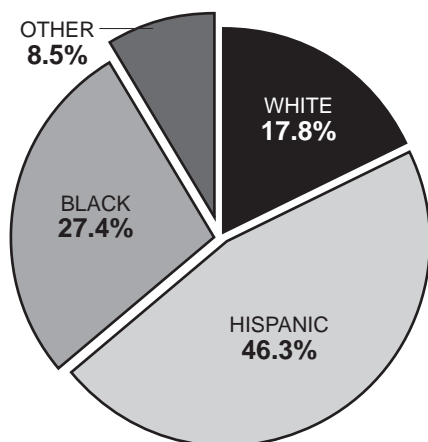

Source: Table 31.

Figure 42
POPULATION IN CALIFORNIA, 2006
By Race/Ethnic Group

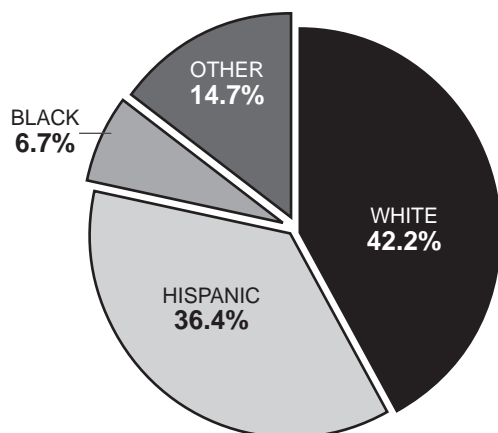

Source: Table 3.
Note: Beginning in 2004, the "other" category includes the race/ethnic group of "Multi-racial."

In 2006, of 1,967 arrests for homicide:

- 17.8 percent (351) of arrestees were white.
- 46.3 percent (910) of arrestees were Hispanic.
- 27.4 percent (539) of arrestees were black.
- 8.5 percent (167) of arrestees fell into the "other" race/ethnic group category.

Note: The subjectivity of the classification and labeling process must be considered in the analysis of race/ethnic group data. As commonly used, race refers to large populations which share certain similar physical characteristics such as skin color. Because these physical characteristics can vary greatly within groups as well as between groups, determination of race is frequently, by necessity, subjective. Ethnicity refers to cultural heritage and can cross racial lines. For example, the ethnic designation "Hispanic" can include persons of any race. Most commonly, self-identification of race/ethnicity is used in the classification and labeling process.

In 2006, the largest percentage of homicide arrestees were Hispanic (46.3 percent).

In 2006, of 1,967 arrests for homicide:

- 12.3 percent (241) of arrestees were under age 18.
- 58.7 percent (1,154) of arrestees were aged 18–29.
- 13.6 percent (267) of arrestees were aged 30–39.
- 15.5 percent (305) of arrestees were aged 40 and over.

Figure 43
HOMICIDE ARRESTS, 2006
By Age of Arrestee

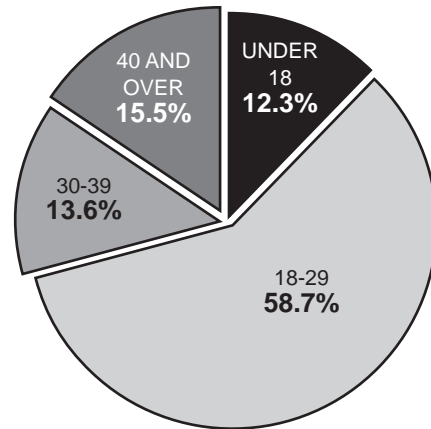

Source: Table 32.
Note: Percentages do not add to 100.0 because of rounding.

Figure 44
POPULATION IN CALIFORNIA, 2006
By Age

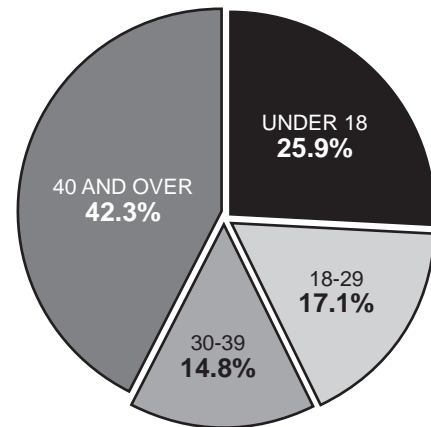

Source: Table 4.
Note: Percentages do not add to 100.0 because of rounding.

The majority of homicide arrestees continue to be in the 18–29 age group (58.7 percent).

Figure 45
HOMICIDE ARRESTS, 2006
Race/Ethnic Group of Arrestee by Gender of Arrestee

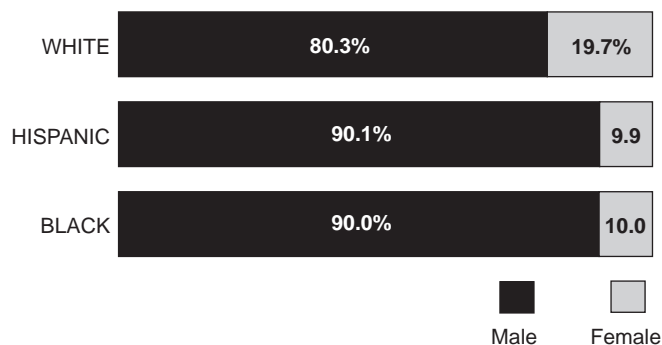

Source: Table 33.

Figure 46
HOMICIDE ARRESTS, 2006
Race/Ethnic Group of Arrestee by Age of Arrestee

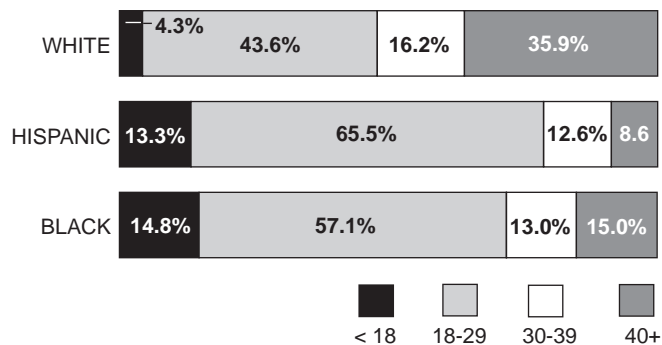

Source: Table 33.

Note: Percentages may not add to 100.0 because of rounding.

In 2006,

- Homicide arrestees for all three race/ethnic groups shown were predominately male.
- A greater percentage of white arrestees were female than were Hispanic or black arrestees (19.7 vs. 9.9 and 10.0 percent, respectively).

In 2006,

- A greater percentage of white arrestees were aged 40 and over than were Hispanic or black arrestees in the same age group (35.9 vs. 8.6 and 15.0 percent, respectively).
- The largest percentage of Hispanic and black arrestees fell into the “18–29” age category (65.5 and 57.1 percent, respectively).

***DEATH PENALTY
SENTENCES***



DEATH PENALTY SENTENCES

This section contains information about persons sentenced to death in California in 2006. Death penalty data were extracted from the 2006 Offender-Based Transaction Statistics system. For detailed information regarding the death penalty and the criteria by which a person can be sentenced to death, refer to California Penal Code sections 190 through 190.9.

Figure 47
 PERSONS UNDER CALIFORNIA
 SENTENCE OF DEATH, 1978–2006

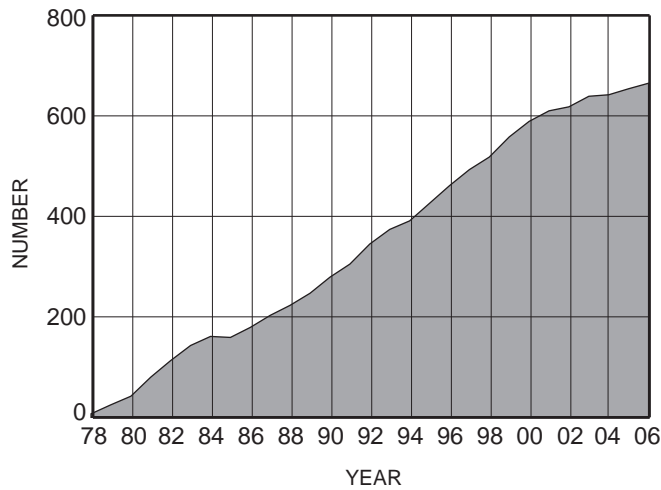

Source: Table 35.

During 2006, there were 17 persons convicted of first-degree murder and sentenced to death. These were initial death sentences only and do not include persons who were resentenced to death after their death sentences were reversed on appeal. By the end of 2006, there were 665 persons under sentence of death in California.

In 2006, of the 17 persons newly sentenced to death:

- 16 were male and 1 was female.
- Seven were white; five were Hispanic; four were black; and one was in the "other" race category.
- The average age at arrest was 32.
- San Bernardino County sentenced the largest number with four.

Additional information can be found in Tables 35 and 36.

***PEACE OFFICERS
KILLED IN THE
LINE OF DUTY***



PEACE OFFICERS KILLED IN THE LINE OF DUTY

Information about peace officers killed in the line of duty was obtained from the Homicide File. Only sworn officers *feloniously* killed in the line of duty are included. (Sworn officers accidentally killed in the line of duty and non-sworn officers, such as security guards, are excluded.)

In 2006, five peace officers were killed in the line of duty.

- Four peace officers were killed by the offenders' handgun.
- One peace officer was killed by the offender's rifle.

From 1997 to 2006:

- There were 50 peace officers killed in the line of duty. During this time period, the largest number of deaths occurred in 1997 and 1998, and the fewest number of deaths occurred in 2000.

Table N-2
PEACE OFFICERS KILLED IN THE LINE OF DUTY, 2006
By Type of Weapon Used

Type of weapon used	Total	Offender's	Officer's
Total.....	5	5	0
Handgun	4	4	0
Rifle.....	1	1	0

Table N-3
PEACE OFFICERS KILLED IN THE LINE OF DUTY, 1997-2006

Year(s)	Number of officers killed
Total	50
2006.....	5
2005.....	5
2004.....	4
2003.....	6
2002.....	4
2001.....	6
2000.....	2
1999.....	4
1998.....	7
1997.....	7

Figure 48
 HOMICIDE CRIMES AND PEACE OFFICERS KILLED
 IN THE LINE OF DUTY, 1997–2006
 Homicide Rate per 100,000 Respective Population

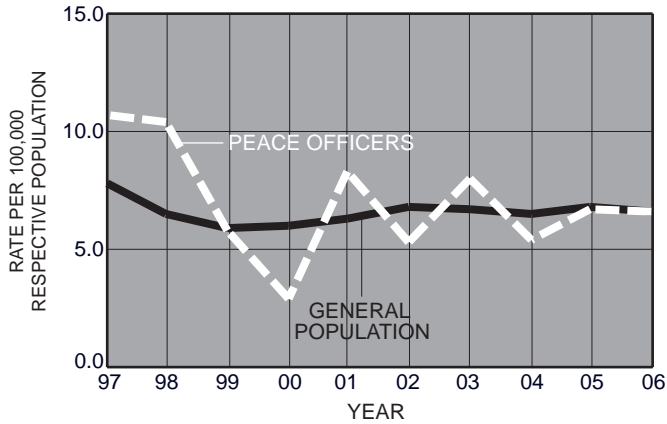

Source: Table 37.

Table N-4
 PEACE OFFICERS KILLED
 IN THE LINE OF DUTY, 2006
 Race/Ethnic Group of Officer by Gender of Officer

Race/ethnic group	Total	Gender	
		Male	Female
Total.....	5	5	0
White.....	4	4	0
Hispanic.....	1	1	0

In 2006,

- The homicide rate for the general population and for peace officers killed in the line of duty was the same (6.6 per 100,000 population).

Comparing 1997 to 2006:

- The general population homicide rate decreased 15.4 percent (7.8 to 6.6). The homicide rate for peace officers killed in the line of duty decreased 38.3 percent (10.7 to 6.6).

Additional information can be found in Tables 37 and 38.

In 2006,

- All five peace officers killed in the line of duty were male; four were white, one was Hispanic.

***JUSTIFIABLE
HOMICIDE***

JUSTIFIABLE HOMICIDES

A justifiable homicide is defined by the Uniform Crime Reporting (UCR) Program as the killing of a felon by a private citizen or peace officer during the commission of a felony. Justifiable homicides are sometimes referred to as excusable or noncriminal homicides.

In 2006, when justifiable homicides were examined by gender, it was found that:

- ☐ 96.0 percent of felons (119) killed by peace officers were male; 4.0 percent were female (5).
- ☐ 100.0 percent of felons (33) killed by private citizens were male.

Figure 49
JUSTIFIABLE HOMICIDES BY PEACE OFFICERS
OR PRIVATE CITIZENS, 2006
By Gender of Deceased

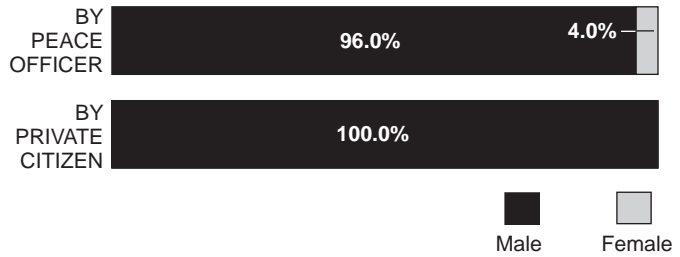

Source: Table 39.

Figure 50
JUSTIFIABLE HOMICIDES BY PEACE OFFICERS
OR PRIVATE CITIZENS, 2006
By Race/Ethnic Group of Deceased

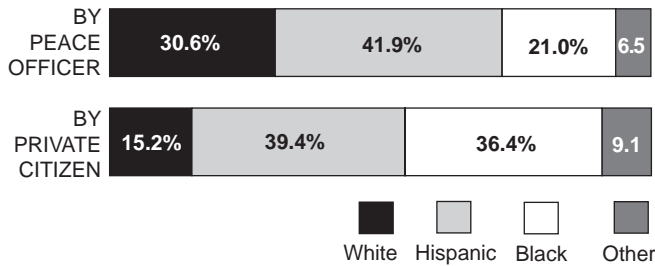

Source: Table 39.
Note: Percentages may not add to 100.0 because of rounding.

Figure 51
JUSTIFIABLE HOMICIDES BY PEACE OFFICERS
OR PRIVATE CITIZENS, 2006
By Age of Deceased

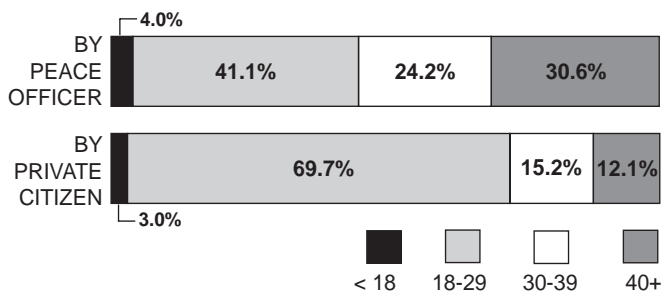

Source: Table 39.
Note: Percentages may not add to 100.0 because of rounding.

In 2006,

- ❑ 30.6 percent (38) of felons killed by peace officers were white, 41.9 percent (52) were Hispanic, 21.0 percent (26) were black, and 6.5 percent (8) were in the “other” race/ethnic group category.
- ❑ 15.2 percent (5) of felons killed by private citizens were white, 39.4 percent (13) were Hispanic, 36.4 percent (12) were black, and 9.1 percent (3) were in the “other” race/ethnic group category.
- ❑ 4.0 percent (5) of felons killed by peace officers were under age 18, 41.1 percent (51) were aged 18–29, 24.2 percent (30) were aged 30–39, and 30.6 percent (38) were aged 40 and over.
- ❑ 3.0 percent (1) of felons killed by private citizens were under age 18, 69.7 percent (23) of felons killed by private citizens were aged 18–29, 15.2 percent (5) were aged 30–39, and 12.1 percent (4) were aged 40 and over.



In 2006, when justifiable homicides were examined by location, it was found that:

- Most felons killed by peace officers were killed on a street or sidewalk (57.3 percent).
- The largest percentage of felons killed by private citizens fell into the “other residence” category (48.5 percent).

Figure 52
JUSTIFIABLE HOMICIDES BY PEACE OFFICERS, 2006
By Location of Justifiable Homicide

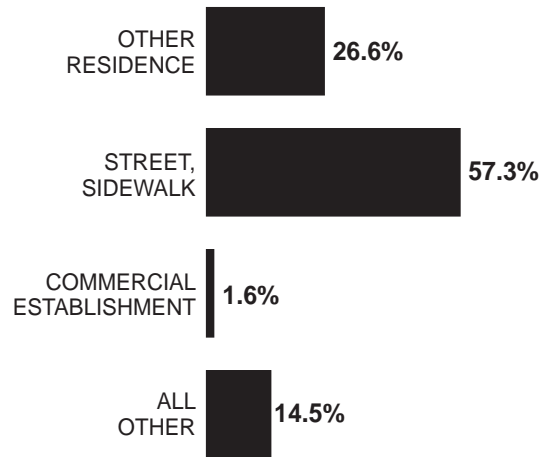

Source: Table 40.

Figure 53
JUSTIFIABLE HOMICIDES BY PRIVATE CITIZENS, 2006
By Location of Justifiable Homicide

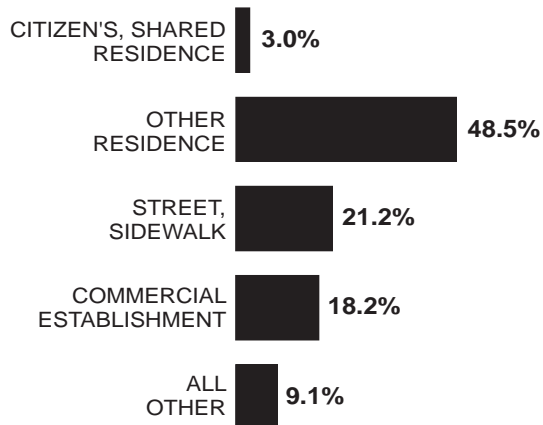

Source: Table 40.

Figure 54
JUSTIFIABLE HOMICIDES BY PEACE OFFICERS, 2006
By Contributing Circumstance

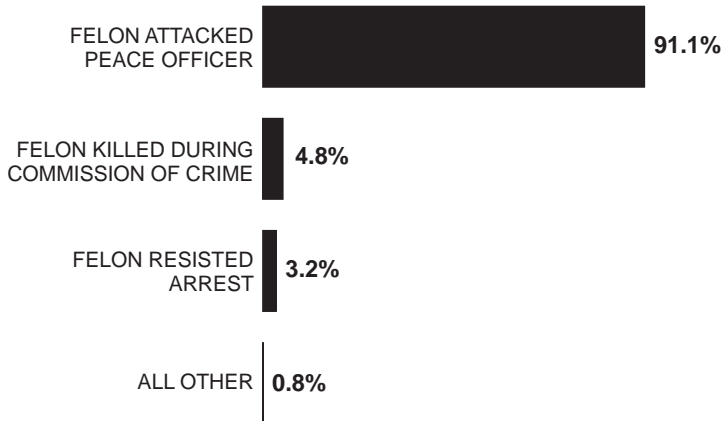

Source: Table 41.
Note: Percentages do not add to 100.0 because of rounding.

Figure 55
JUSTIFIABLE HOMICIDES BY PRIVATE CITIZENS, 2006
By Contributing Circumstance

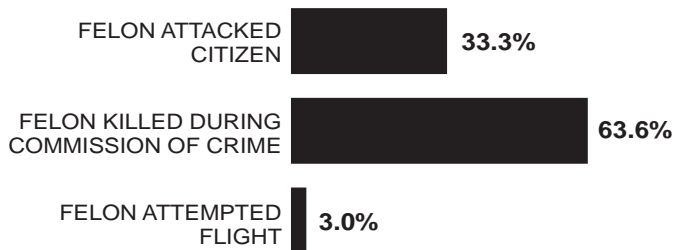

Source: Table 41.
Note: Percentages do not add to 100.0 because of rounding.

In 2006, when justifiable homicides were examined by contributing circumstance, it was found that:

- Most felons killed by peace officers were killed while attacking a peace officer (91.1 percent).
- Most felons killed by private citizens were killed while committing a crime (63.6 percent).

DATA TABLES

Table 1
VIOLENT CRIMES, 1997-2006
 Number, Rate per 100,000 Population, and Percent Change

Year(s)	Total	Homi- cide	Forcible rape	Robbery	Aggra- vated assault
Number					
2006.....	194,128	2,483	9,213	70,961	111,471
2005.....	189,593	2,503	9,345	63,424	114,321
2004.....	197,432	2,394	9,598	61,573	123,867
2003.....	204,591	2,402	9,918	63,597	128,674
2002.....	207,988	2,392	10,176	64,805	130,615
2001.....	210,510	2,201	9,882	63,299	135,128
2000.....	210,492	2,074	9,785	60,243	138,390
1999.....	207,874	2,006	9,443	60,027	136,398
1998.....	229,766	2,170	9,777	68,752	149,067
1997.....	257,409	2,579	10,182	81,413	163,235
Percent change in number					
2005-2006.....	2.4	-0.8	-1.4	11.9	-2.5
2004-2005.....	-4.0	4.6	-2.6	3.0	-7.7
2003-2004.....	-3.5	-0.3	-3.2	-3.2	-3.7
2002-2003.....	-1.6	0.4	-2.5	-1.9	-1.5
2001-2002.....	-1.2	8.7	3.0	2.4	-3.3
2000-2001.....	0.0	6.1	1.0	5.1	-2.4
1999-2000.....	1.3	3.4	3.6	0.4	1.5
1998-1999.....	-9.5	-7.6	-3.4	-12.7	-8.5
1997-1998.....	-10.7	-15.9	-4.0	-15.6	-8.7
1997-2006.....	-24.6	-3.7	-9.5	-12.8	-31.7
Rate per 100,000 population ¹					
2006.....	518.4	6.6	24.6	189.5	297.7
2005.....	512.3	6.8	25.3	171.4	308.9
2004.....	539.6	6.5	26.2	168.3	338.5
2003.....	569.4	6.7	27.6	177.0	358.1
2002.....	589.2	6.8	28.8	183.6	370.0
2001.....	605.6	6.3	28.4	182.1	388.8
2000.....	610.5	6.0	28.4	174.7	401.4
1999.....	610.7	5.9	27.7	176.4	400.7
1998.....	686.0	6.5	29.2	205.3	445.1
1997.....	781.0	7.8	30.9	247.0	495.3
Percent change in rate					
2005-2006.....	1.2	-2.9	-2.8	10.6	-3.6
2004-2005.....	-5.1	4.6	-3.4	1.8	-8.7
2003-2004.....	-5.2	-3.0	-5.1	-4.9	-5.5
2002-2003.....	-3.4	-1.5	-4.2	-3.6	-3.2
2001-2002.....	-2.7	7.9	1.4	0.8	-4.8
2000-2001.....	-0.8	5.0	0.0	4.2	-3.1
1999-2000.....	0.0	1.7	2.5	-1.0	0.2
1998-1999.....	-11.0	-9.2	-5.1	-14.1	-10.0
1997-1998.....	-12.2	-16.7	-5.5	-16.9	-10.1
1997-2006.....	-33.6	-15.4	-20.4	-23.3	-39.9

Note: Rates may not add to total because of rounding.

¹ Rates are based on annual population estimates provided by the Demographic Research Unit, California Department of Finance.

Table 2
HOMICIDE CRIMES, 1997-2006
 By Gender of Victim
 Number, Percent, and Rate per 100,000 Population

Gender of victim ¹	1997	1998	1999	2000	2001	2002	2003	2004	2005	2006	Percent change	
											1997-2006	2005-2006
Total												
Number of victims.....	2,579	2,170	2,006	2,074	2,201	2,392	2,402	2,394	2,503	2,483	-3.7	-0.8
Percent of victims.....	100.0%	100.0%	100.0%	100.0%	100.0%	100.0%	100.0%	100.0%	100.0%	100.0%		
Population.....	32,957,000	33,494,000	34,036,000	34,480,000	34,758,000	35,301,000	35,934,000	36,590,814	37,004,661	37,444,385	13.6	1.2
Percent of population.....	100.0%	100.0%	100.0%	100.0%	100.0%	100.0%	100.0%	100.0%	100.0%	100.0%		
Rate.....	7.8	6.5	5.9	6.0	6.3	6.8	6.7	6.5	6.8	6.6	-15.4	-2.9
Male²												
Number of victims.....	2,097	1,727	1,568	1,666	1,756	1,938	1,972	1,992	2,101	2,070	-1.3	-1.5
Percent of total victims.	81.3%	79.6%	78.2%	80.3%	79.8%	81.0%	82.1%	83.2%	83.9%	83.4%		
Population.....	17,135,207	16,810,163	17,099,812	17,398,995	17,694,411	17,984,195	18,270,127	18,161,654	18,403,806	18,645,304	8.8	1.3
Percent of population...	50.0%	50.2%	50.2%	50.2%	50.2%	50.2%	50.2%	49.9%	49.9%	49.9%		
Rate.....	12.2	10.3	9.2	9.6	9.9	10.8	10.8	11.0	11.4	11.1	-9.0	-2.6
Female												
Number of victims.....	482	443	438	408	445	454	430	402	402	413	-14.3	2.7
Percent of total victims.	18.7%	20.4%	21.8%	19.7%	20.2%	19.0%	17.9%	16.8%	16.1%	16.6%		
Population.....	17,159,994	16,696,243	16,972,666	17,254,400	17,538,924	17,818,043	18,093,375	18,214,757	18,450,418	18,689,664	8.9	1.3
Percent of population...	50.0%	49.8%	49.8%	49.8%	49.8%	49.8%	49.8%	50.1%	50.1%	50.1%		
Rate.....	2.8	2.7	2.6	2.4	2.5	2.5	2.4	2.2	2.2	2.2	-21.4	0.0

Notes: Rates are based on annual population estimates provided by the Demographic Research Unit, California Department of Finance.

Rates are calculated using the population for each subgroup shown; therefore, they will not add to the rate calculated for the total population.

Population breakdowns by gender will not add to total because of variations in population source data.

The "percent of population" category for male and female was calculated using the sum of the male and female populations.

¹ Beginning in 2004, population estimates are based on the 2000 Census. Previous population estimates are based on revisions of the 1990 Census. Readers are advised to exercise care in interpreting changes in percent and rate between decennial census samples.

² The "male" category includes homicide victims whose gender could not be determined: 1997 includes five, 2000 includes two, 2001 includes one, and 2002 includes one.

Table 3
HOMICIDE CRIMES, 1997-2006
 By Race/Ethnic Group of Victim
 Number, Percent, and Rate per 100,000 Population

Race/ethnic group of victim ¹	1997	1998	1999	2000	2001	2002	2003	2004	2005	2006	Percent change	
											1997-2006	2005-2006
Total												
Number of victims.....	2,579	2,170	2,006	2,074	2,201	2,392	2,402	2,394	2,503	2,483	-3.7	-0.8
Percent of total victims.....	100.0%	100.0%	100.0%	100.0%	100.0%	100.0%	100.0%	100.0%	100.0%	100.0%		
Population.....	32,957,000	33,494,000	34,036,000	34,480,000	34,758,000	35,301,000	35,934,000	36,590,814	37,004,661	37,444,385	13.6	1.2
Percent of population.....	100.0%	100.0%	100.0%	100.0%	100.0%	100.0%	100.0%	100.0%	100.0%	100.0%		
Rate.....	7.8	6.5	5.9	6.0	6.3	6.8	6.7	6.5	6.8	6.6	-15.4	-2.9
White												
Number of victims.....	547	523	446	421	442	417	444	422	419	432	-21.0	3.1
Percent of total victims..	21.2%	24.1%	22.2%	20.3%	20.1%	17.4%	18.5%	17.6%	16.7%	17.4%		
Population.....	17,849,510	17,258,003	17,339,690	17,421,511	17,503,225	17,573,850	17,635,296	15,967,775	15,852,937	15,766,736	-11.7	-0.5
Percent of population....	52.0%	51.5%	50.9%	50.3%	49.7%	49.1%	48.5%	43.9%	43.0%	42.2%		
Rate.....	3.1	3.0	2.6	2.4	2.5	2.4	2.5	2.6	2.6	2.7	-12.9	3.8
Hispanic												
Number of victims.....	1,154	964	909	933	985	1,066	1,053	1,034	1,139	1,129	-2.2	-0.9
Percent of total victims..	44.7%	44.4%	45.3%	45.0%	44.8%	44.6%	43.8%	43.2%	45.5%	45.5%		
Population.....	10,421,039	10,022,551	10,352,763	10,688,752	11,020,710	11,352,852	11,685,915	12,816,038	13,220,223	13,603,759	30.5	2.9
Percent of population....	30.4%	29.9%	30.4%	30.8%	31.3%	31.7%	32.1%	35.2%	35.9%	36.4%		
Rate.....	11.1	9.6	8.8	8.7	8.9	9.4	9.0	8.1	8.6	8.3	-25.2	-3.5
Black												
Number of victims.....	682	523	488	589	622	734	713	766	758	736	7.9	-2.9
Percent of total victims..	26.4%	24.1%	24.3%	28.4%	28.3%	30.7%	29.7%	32.0%	30.3%	29.6%		
Population.....	2,314,836	2,309,152	2,320,916	2,337,935	2,355,812	2,373,399	2,390,411	2,425,066	2,456,783	2,491,247	7.6	1.4
Percent of population....	6.7%	6.9%	6.8%	6.7%	6.7%	6.6%	6.6%	6.7%	6.7%	6.7%		
Rate.....	29.5	22.6	21.0	25.2	26.4	30.9	29.8	31.6	30.9	29.5	0.0	-4.5
Other²												
Number of victims.....	177	147	157	121	145	166	185	167	182	178	0.6	-2.2
Percent of total victims..	6.9%	6.8%	7.8%	5.8%	6.6%	6.9%	7.7%	7.0%	7.3%	7.2%		
Population.....	3,709,816	3,916,700	4,059,109	4,205,197	4,353,588	4,502,137	4,651,880	5,167,532	5,324,281	5,473,226	47.5	2.8
Percent of population....	10.8%	11.7%	11.9%	12.1%	12.4%	12.6%	12.8%	14.2%	14.4%	14.7%		
Rate.....	4.8	3.8	3.9	2.9	3.3	3.7	4.0	3.2	3.4	3.3	-31.3	-2.9
Unknown												
Number of victims.....	19	13	6	10	7	9	7	5	5	8	-	-
Percent of total victims..	0.7%	0.6%	0.3%	0.5%	0.3%	0.4%	0.3%	0.2%	0.2%	0.3%		
Population.....	-	-	-	-	-	-	-	-	-	-	-	-
Percent of population....	-	-	-	-	-	-	-	-	-	-	-	-
Rate.....	-	-	-	-	-	-	-	-	-	-	-	-

Notes: Percentages may not add to 100.0 because of rounding.

Rates are based on annual population estimates provided by the Demographic Research Unit, California Department of Finance.

Rates are calculated using the population for each subgroup shown; therefore, they will not add to the rate calculated for the total population.

Population breakdowns by race/ethnic group will not add to total because of variations in population source data.

Dash indicates that the percent of population and rate for the "unknown" category cannot be calculated because there are no unknown race/ethnic group population data.

The "percent of population" category for race/ethnic group was calculated using the sum of the race/ethnic group populations.

¹ Beginning in 2004, population estimates are based on the 2000 Census. Previous population estimates are based on revisions of the 1990 Census. Readers are advised to exercise care in interpreting changes in percent and rate between decennial census samples.

² Beginning in 2004, the "Other" category includes the new race/ethnic group of "Multi-racial." The extent to which this new race/ethnic group effects other population estimates is not known.

Table 4
HOMICIDE CRIMES, 1997-2006
 By Age of Victim
 Number, Percent, and Rate per 100,000 Population

Age of victim	1997	1998	1999	2000	2001	2002	2003	2004	2005	2006	Percent change	
											1997-2006	2005-2006
Total												
Number of victims.....	2,579	2,170	2,006	2,074	2,201	2,392	2,402	2,394	2,503	2,483	-3.7	-0.8
Percent of victims.....	100.0%	100.0%	100.0%	100.0%	100.0%	100.0%	100.0%	100.0%	100.0%	100.0%		
Population.....	32,957,000	33,494,000	34,036,000	34,480,000	34,758,000	35,301,000	35,934,000	36,590,814	37,004,661	37,444,385	13.6	1.2
Percent of population.....	100.0%	100.0%	100.0%	100.0%	100.0%	100.0%	100.0%	100.0%	100.0%	100.0%		
Rate.....	7.8	6.5	5.9	6.0	6.3	6.8	6.7	6.5	6.8	6.6	-15.4	-2.9
Under 18												
Number of victims.....	361	306	276	246	252	247	240	269	285	316	-12.5	10.9
Percent of total victims.	14.0%	14.1%	13.8%	11.9%	11.4%	10.3%	10.0%	11.2%	11.4%	12.7%		
Population.....	9,701,218	9,426,168	9,587,332	9,770,687	9,932,913	10,095,903	10,248,237	9,575,520	9,620,511	9,664,747	-0.4	0.5
Percent of population...	28.3%	28.1%	28.1%	28.2%	28.2%	28.2%	28.2%	26.3%	26.1%	25.9%		
Rate.....	3.7	3.2	2.9	2.5	2.5	2.4	2.3	2.8	3.0	3.3	-10.8	10.0
18-29												
Number of victims.....	1,068	933	840	888	992	1,098	1,100	1,110	1,151	1,147	7.4	-0.3
Percent of total victims.	41.4%	43.0%	41.9%	42.8%	45.1%	45.9%	45.8%	46.4%	46.0%	46.2%		
Population.....	5,537,727	5,474,990	5,511,604	5,523,472	5,555,926	6,123,037	5,740,606	6,160,386	6,260,103	6,369,559	15.0	1.7
Percent of population...	16.1%	16.3%	16.2%	15.9%	15.8%	17.1%	15.8%	16.9%	17.0%	17.1%		
Rate.....	19.3	17.0	15.2	16.1	17.9	17.9	19.2	18.0	18.4	18.0	-6.7	-2.2
30-39												
Number of victims.....	534	428	364	377	426	449	486	446	473	418	-21.7	-11.6
Percent of total victims.	20.7%	19.7%	18.1%	18.2%	19.4%	18.8%	20.2%	18.6%	18.9%	16.8%		
Population.....	5,942,241	5,654,098	5,629,424	5,597,411	5,535,620	4,994,720	5,384,170	5,534,220	5,516,751	5,516,609	-7.2	0.0
Percent of population...	17.3%	16.9%	16.5%	16.2%	15.7%	14.0%	14.8%	15.2%	15.0%	14.8%		
Rate.....	9.0	7.6	6.5	6.7	7.7	9.0	9.0	8.1	8.6	7.6	-15.6	-11.6
40 and over												
Number of victims.....	580	480	505	534	519	579	560	569	579	586	1.0	1.2
Percent of total victims.	22.5%	22.1%	25.2%	25.7%	23.6%	24.2%	23.3%	23.8%	23.1%	23.6%		
Population.....	13,114,015	12,951,150	13,344,118	13,761,825	14,208,876	14,588,578	14,990,489	15,106,285	15,456,859	15,784,053	20.4	2.1
Percent of population...	38.2%	38.7%	39.2%	39.7%	40.3%	40.7%	41.2%	41.5%	41.9%	42.3%		
Rate.....	4.4	3.7	3.8	3.9	3.7	4.0	3.7	3.8	3.7	3.7	-15.9	0.0
Unknown												
Number of victims.....	36	23	21	29	12	19	16	0	15	16	-	-
Percent of total victims.	1.4%	1.1%	1.0%	1.4%	0.5%	0.8%	0.7%	0.0%	0.6%	0.6%		
Population.....	-	-	-	-	-	-	-	-	-	-	-	-
Percent of population...	-	-	-	-	-	-	-	-	-	-	-	-
Rate.....	-	-	-	-	-	-	-	-	-	-	-	-

Notes: Percentages may not add to 100.0 because of rounding.

Rates are based on annual population estimates provided by the Demographic Research Unit, California Department of Finance.

Rates are calculated using the population for each subgroup shown; therefore, they will not add to the rate calculated for the total population.

Population breakdowns by age will not add to total because of variations in population source data.

Dash indicates that the percent of population and rate for the "unknown" category cannot be calculated because there are no unknown age population data.

The "percent of population" category for age group was calculated using the sum of the age populations.

Table 5
HOMICIDE CRIMES, 1997-2006
 By Gender of Victim

Year(s)	Total		Male ¹		Female	
	Number	Percent	Number	Percent	Number	Percent
2006.....	2,483	100.0	2,070	83.4	413	16.6
2005.....	2,503	100.0	2,101	83.9	402	16.1
2004.....	2,394	100.0	1,992	83.2	402	16.8
2003.....	2,402	100.0	1,972	82.1	430	17.9
2002.....	2,392	100.0	1,938	81.0	454	19.0
2001.....	2,201	100.0	1,756	79.8	445	20.2
2000.....	2,074	100.0	1,666	80.3	408	19.7
1999.....	2,006	100.0	1,568	78.2	438	21.8
1998.....	2,170	100.0	1,727	79.6	443	20.4
1997.....	2,579	100.0	2,097	81.3	482	18.7

¹ The "male" category includes homicide victims whose gender could not be determined: 1997 includes five, 2000 includes two, 2001 includes one, and 2002 includes one.

Table 6
HOMICIDE CRIMES, 1997-2006
 By Race/Ethnic Group of Victim

Year(s)	Total including unknown	Unknown	Known race/ethnic group of victim									
			Total		White		Hispanic		Black		Other	
			Number	Percent	Number	Percent	Number	Percent	Number	Percent	Number	Percent
2006.....	2,483	8	2,475	100.0	432	17.5	1,129	45.6	736	29.7	178	7.2
2005.....	2,503	5	2,498	100.0	419	16.8	1,139	45.6	758	30.3	182	7.3
2004.....	2,394	5	2,389	100.0	422	17.7	1,034	43.3	766	32.1	167	7.0
2003.....	2,402	7	2,395	100.0	444	18.5	1,053	44.0	713	29.8	185	7.7
2002.....	2,392	9	2,383	100.0	417	17.5	1,066	44.7	734	30.8	166	7.0
2001.....	2,201	7	2,194	100.0	442	20.1	985	44.9	622	28.4	145	6.6
2000.....	2,074	10	2,064	100.0	421	20.4	933	45.2	589	28.5	121	5.9
1999.....	2,006	6	2,000	100.0	446	22.3	909	45.5	488	24.4	157	7.9
1998.....	2,170	13	2,157	100.0	523	24.2	964	44.7	523	24.2	147	6.8
1997.....	2,579	19	2,560	100.0	547	21.4	1,154	45.1	682	26.6	177	6.9

Note: Percentages may not add to 100.0 because of rounding.

Table 7
HOMICIDE CRIMES, 1997-2006
 By Age of Victim

Year(s)	Total including unknown	Unknown	Known age of victim									
			Total		Under 18		18-29		30-39		40 and over	
			Number	Percent	Number	Percent	Number	Percent	Number	Percent	Number	Percent
2006.....	2,483	16	2,467	100.0	316	12.8	1,147	46.5	418	16.9	586	23.8
2005.....	2,503	15	2,488	100.0	285	11.5	1,151	46.3	473	19.0	579	23.3
2004.....	2,394	0	2,394	100.0	269	11.2	1,110	46.4	446	18.6	569	23.8
2003.....	2,402	16	2,386	100.0	240	10.1	1,100	46.1	486	20.4	560	23.5
2002.....	2,392	19	2,373	100.0	247	10.4	1,098	46.3	449	18.9	579	24.4
2001.....	2,201	12	2,189	100.0	252	11.5	992	45.3	426	19.5	519	23.7
2000.....	2,074	29	2,045	100.0	246	12.0	888	43.4	377	18.4	534	26.1
1999.....	2,006	21	1,985	100.0	276	13.9	840	42.3	364	18.3	505	25.4
1998.....	2,170	23	2,147	100.0	306	14.3	933	43.5	428	19.9	480	22.4
1997.....	2,579	36	2,543	100.0	361	14.2	1,068	42.0	534	21.0	580	22.8

Note: Percentages may not add to 100.0 because of rounding.

Table 8
HOMICIDE CRIMES, 2006
 Race/Ethnic Group of Victim by Gender of Victim

Gender of victim	Total		White		Hispanic		Black		Other		Unknown	
	Number	Percent	Number	Percent	Number	Percent	Number	Percent	Number	Percent	Number	Percent
Total.....	2,483	100.0	432	100.0	1,129	100.0	736	100.0	178	100.0	8	100.0
Male.....	2,070	83.4	282	65.3	1,008	89.3	632	85.9	144	80.9	4	-
Female.....	413	16.6	150	34.7	121	10.7	104	14.1	34	19.1	4	-

Note: Dash indicates that percent distributions are not calculated when the base number is less than 50.

Table 9
HOMICIDE CRIMES, 2006
 Race/Ethnic Group of Victim by Age of Victim

Age of victim	Total		White		Hispanic		Black		Other		Unknown	
	Number	Percent	Number	Percent	Number	Percent	Number	Percent	Number	Percent	Number	Percent
Total including unknown..	2,483		432		1,129		736		178		8	
Unknown.....	16		0		5		4		0		7	
Total known.....	2,467	100.0	432	100.0	1,124	100.0	732	100.0	178	100.0	1	100.0
Under 18.....	316	12.8	42	9.7	162	14.4	90	12.3	21	11.8	1	-
18-29.....	1,147	46.5	112	25.9	610	54.3	347	47.4	78	43.8	0	-
30-39.....	418	16.9	64	14.8	194	17.3	135	18.4	25	14.0	0	-
40 and over.....	586	23.8	214	49.5	158	14.1	160	21.9	54	30.3	0	-

Notes: Percentages may not add to 100.0 because of rounding.

Dash indicates that percent distributions are not calculated when the base number is less than 50.

Table 10
HOMICIDE CRIMES, 2006
Race/Ethnic Group of Victim by Gender and Age of Victim

Gender and age of victim	Total		White		Hispanic		Black		Other		Unknown	
	Number	Percent	Number	Percent	Number	Percent	Number	Percent	Number	Percent	Number	Percent
Total.....	2,483	100.0	432	100.0	1,129	100.0	736	100.0	178	100.0	8	100.0
Under 18.....	316	12.7	42	9.7	162	14.3	90	12.2	21	11.8	1	-
18-19.....	263	10.6	21	4.9	147	13.0	73	9.9	22	12.4	0	-
20-24.....	504	20.3	50	11.6	272	24.1	146	19.8	36	20.2	0	-
25-29.....	380	15.3	41	9.5	191	16.9	128	17.4	20	11.2	0	-
30-34.....	231	9.3	27	6.3	112	9.9	75	10.2	17	9.6	0	-
35-39.....	187	7.5	37	8.6	82	7.3	60	8.2	8	4.5	0	-
40-44.....	146	5.9	30	6.9	50	4.4	57	7.7	9	5.1	0	-
45-49.....	154	6.2	44	10.2	51	4.5	43	5.8	16	9.0	0	-
50-54.....	109	4.4	43	10.0	30	2.7	27	3.7	9	5.1	0	-
55 and over.....	177	7.1	97	22.5	27	2.4	33	4.5	20	11.2	0	-
Unknown.....	16	0.6	0	0.0	5	0.4	4	0.5	0	0.0	7	-
Male.....	2,070	100.0	282	100.0	1,008	100.0	632	100.0	144	100.0	4	100.0
Under 18.....	253	12.2	22	7.8	137	13.6	77	12.2	17	11.8	0	-
18-19.....	241	11.6	15	5.3	141	14.0	65	10.3	20	13.9	0	-
20-24.....	453	21.9	34	12.1	254	25.2	133	21.0	32	22.2	0	-
25-29.....	336	16.2	36	12.8	172	17.1	111	17.6	17	11.8	0	-
30-34.....	201	9.7	20	7.1	100	9.9	66	10.4	15	10.4	0	-
35-39.....	159	7.7	27	9.6	73	7.2	53	8.4	6	4.2	0	-
40-44.....	107	5.2	20	7.1	39	3.9	42	6.6	6	4.2	0	-
45-49.....	119	5.7	30	10.6	43	4.3	35	5.5	11	7.6	0	-
50-54.....	73	3.5	26	9.2	23	2.3	19	3.0	5	3.5	0	-
55 and over..	118	5.7	52	18.4	22	2.2	29	4.6	15	10.4	0	-
Unknown.....	10	0.5	0	0.0	4	0.4	2	0.3	0	0.0	4	-
Female.....	413	100.0	150	100.0	121	100.0	104	100.0	34	100.0	4	100.0
Under 18.....	63	15.3	20	13.3	25	20.7	13	12.5	4	-	1	-
18-19.....	22	5.3	6	4.0	6	5.0	8	7.7	2	-	0	-
20-24.....	51	12.3	16	10.7	18	14.9	13	12.5	4	-	0	-
25-29.....	44	10.7	5	3.3	19	15.7	17	16.3	3	-	0	-
30-34.....	30	7.3	7	4.7	12	9.9	9	8.7	2	-	0	-
35-39.....	28	6.8	10	6.7	9	7.4	7	6.7	2	-	0	-
40-44.....	39	9.4	10	6.7	11	9.1	15	14.4	3	-	0	-
45-49.....	35	8.5	14	9.3	8	6.6	8	7.7	5	-	0	-
50-54.....	36	8.7	17	11.3	7	5.8	8	7.7	4	-	0	-
55 and over..	59	14.3	45	30.0	5	4.1	4	3.8	5	-	0	-
Unknown.....	6	1.5	0	0.0	1	0.8	2	1.9	0	-	3	-

Notes: Percentages may not add to 100.0 because of rounding.

Dash indicates that percent distributions are not calculated when the base number is less than 50.

Table 11
HOMICIDE CRIMES, 1997-2006
 By Relationship of Victim to Offender

Relationship of victim to offender	1997		1998		1999		2000		2001	
	Number	Percent	Number	Percent	Number	Percent	Number	Percent	Number	Percent
Total including unknown.....	2,579		2,170		2,006		2,074		2,201	
Unknown.....	859		625		761		796		900	
Total known.....	1,720	100.0	1,545	100.0	1,245	100.0	1,278	100.0	1,301	100.0
Friend, acquaintance ¹	869	50.5	766	49.6	632	50.8	601	47.0	596	45.8
Spouse, parent, child.....	203	11.8	192	12.4	202	16.2	207	16.2	183	14.1
Spouse ²	89	5.2	83	5.4	85	6.8	115	9.0	87	6.7
Parent, child ³	114	6.6	109	7.1	117	9.4	92	7.2	96	7.4
All other relatives.....	46	2.7	41	2.7	49	3.9	40	3.1	49	3.8
Stranger.....	602	35.0	546	35.3	362	29.1	430	33.6	473	36.4

Relationship of victim to offender (cont.)	2002		2003		2004		2005		2006		Percent change	
	Number	Percent	Number	Percent	Number	Percent	Number	Percent	Number	Percent	1997- 2006	2005- 2006
Total including unknown.....	2,392		2,402		2,394		2,503		2,483			
Unknown.....	969		1,109		1,018		1,082		1,109			
Total known.....	1,423	100.0	1,293	100.0	1,376	100.0	1,421	100.0	1,374	100.0	-20.1	-3.3
Friend, acquaintance ¹	663	46.6	601	46.5	667	48.5	548	38.6	593	43.2	-31.8	8.2
Spouse, parent, child.....	204	14.3	198	15.3	174	12.6	174	12.2	180	13.1	-11.3	3.4
Spouse ²	97	6.8	93	7.2	84	6.1	77	5.4	86	6.3	-3.4	11.7
Parent, child ³	107	7.5	105	8.1	90	6.5	97	6.8	94	6.8	-17.5	-3.1
All other relatives.....	42	3.0	52	4.0	46	3.3	61	4.3	43	3.1	-	-29.5
Stranger.....	514	36.1	442	34.2	489	35.5	638	44.9	558	40.6	-7.3	-12.5

Notes: Percentages may not add to subtotals or 100.0 because of rounding.

Dash indicates that a percent change is not calculated when the base number is less than 50.

¹ Includes ex-husband, ex-wife, employer, employee, gang member, etc.

² Includes "common-law" marriage partner.

³ Includes stepmother, stepfather, stepdaughter, and stepson.

Table 12
HOMICIDE CRIMES, 2006
 Gender and Race/Ethnic Group of Victim by Relationship of Victim to Offender

Relationship of victim to offender	Total	Gender		Race/ethnic group				
		Male	Female	White	Hispanic	Black	Other	Unknown
Number								
Total including unknown.....	2,483	2,070	413	432	1,129	736	178	8
Unknown.....	1,109	994	115	120	502	414	65	8
Total known.....	1,374	1,076	298	312	627	322	113	0
Friend, acquaintance ¹	593	479	114	119	264	168	42	0
Spouse, parent, child.....	180	65	115	80	59	23	18	0
Spouse ²	86	17	69	41	26	9	10	0
Parent, child ³	94	48	46	39	33	14	8	0
All other relatives.....	43	28	15	11	19	12	1	0
Stranger.....	558	504	54	102	285	119	52	0
Percent based on total known								
Total known.....	100.0	100.0	100.0	100.0	100.0	100.0	100.0	100.0
Friend, acquaintance ¹	43.2	44.5	38.3	38.1	42.1	52.2	37.2	-
Spouse, parent, child.....	13.1	6.0	38.6	25.6	9.4	7.1	15.9	-
Spouse ²	6.3	1.6	23.2	13.1	4.1	2.8	8.8	-
Parent, child ³	6.8	4.5	15.4	12.5	5.3	4.3	7.1	-
All other relatives.....	3.1	2.6	5.0	3.5	3.0	3.7	0.9	-
Stranger.....	40.6	46.8	18.1	32.7	45.5	37.0	46.0	-

Notes: Percentages may not add to 100.0 because of rounding.

Dash indicates that percent distributions are not calculated when the base number is less than 50.

¹ Includes ex-husband, ex-wife, employer, employee, gang member, etc.

² Includes "common-law" marriage partner.

³ Includes stepmother, stepfather, stepdaughter, and stepson.

Table 13
HOMICIDE CRIMES, 2006
 Age of Victim by Relationship of Victim to Offender

Relationship of victim to offender	Total	Under 18	18-29	30-39	40 and over	Unknown
Number						
Total including unknown.....	2,483	316	1,147	418	586	16
Unknown.....	1,109	122	569	186	219	13
Total known.....	1,374	194	578	232	367	3
Friend, acquaintance ¹	593	80	257	104	151	1
Spouse, parent, child.....	180	52	20	21	87	0
Spouse ²	86	0	18	17	51	0
Parent, child ³	94	52	2	4	36	0
All other relatives.....	43	9	11	7	16	0
Stranger.....	558	53	290	100	113	2
Percent based on total known						
Total known.....	100.0	100.0	100.0	100.0	100.0	100.0
Friend, acquaintance ¹	43.2	41.2	44.5	44.8	41.1	-
Spouse, parent, child.....	13.1	26.8	3.5	9.1	23.7	-
Spouse ²	6.3	0.0	3.1	7.3	13.9	-
Parent, child ³	6.8	26.8	0.3	1.7	9.8	-
All other relatives.....	3.1	4.6	1.9	3.0	4.4	-
Stranger.....	40.6	27.3	50.2	43.1	30.8	-

Notes: Percentages may not add to subtotals or 100.0 because of rounding.

Dash indicates that percent distributions are not calculated when the base number is less than 50.

¹ Includes ex-husband, ex-wife, employer, employee, gang member, etc.

² Includes "common-law" marriage partner.

³ Includes stepmother, stepfather, stepdaughter, and stepson.

Table 14
HOMICIDE CRIMES, 1997-2006
 By County
 Number and Rate per 100,000 Population

County	1997	1998	1999	2000	2001	2002	2003	2004	2005	2006
Number										
Statewide total.....	2,579	2,170	2,006	2,074	2,201	2,392	2,402	2,394	2,503	2,483
Alameda.....	142	107	85	110	108	144	139	117	126	172
Alpine.....	0	0	0	0	0	0	0	0	0	0
Amador.....	0	0	1	1	0	0	0	2	0	2
Butte.....	8	6	4	8	11	5	9	6	10	11
Calaveras.....	2	2	0	4	2	2	2	3	2	1
Colusa.....	2	1	3	4	0	0	0	0	0	0
Contra Costa.....	63	54	57	56	49	48	74	76	80	93
Del Norte.....	1	0	1	1	1	2	0	1	1	0
El Dorado.....	4	7	3	3	5	4	2	2	5	4
Fresno.....	84	57	43	38	61	62	59	69	77	74
Glenn.....	0	3	1	1	0	0	2	0	0	1
Humboldt.....	8	5	12	4	7	12	8	5	3	5
Imperial.....	5	8	2	4	5	3	12	4	0	3
Inyo.....	1	0	0	1	0	0	2	0	1	0
Kern.....	55	55	52	37	39	51	46	51	69	65
Kings.....	5	5	1	3	1	4	5	6	4	4
Lake.....	5	6	4	5	1	4	1	1	1	7
Lassen.....	0	1	4	0	0	0	0	0	3	1
Los Angeles.....	1,176	959	891	1,000	1,070	1,162	1,053	1,038	1,068	1,012
Madera.....	6	12	6	10	15	6	7	7	10	2
Marin.....	1	1	2	5	3	4	0	3	3	3
Mariposa.....	1	1	2	0	0	0	0	1	0	1
Mendocino.....	7	6	7	5	4	4	9	6	4	6
Merced.....	17	17	14	6	5	18	16	16	22	22
Modoc.....	0	0	0	0	1	0	0	0	0	0
Mono.....	0	0	0	1	0	0	1	0	0	0
Monterey.....	33	27	29	25	26	28	27	33	14	15
Napa.....	2	1	2	3	1	2	2	3	1	2
Nevada.....	0	3	6	1	6	3	2	1	2	2
Orange.....	102	85	92	56	63	77	64	81	77	79

(continued)

Table 14 - continued
HOMICIDE CRIMES, 1997-2006
 By County
 Number and Rate per 100,000 Population

County	1997	1998	1999	2000	2001	2002	2003	2004	2005	2006
Number										
Placer.....	3	7	1	5	3	0	10	3	5	6
Plumas.....	0	1	1	1	1	0	2	2	0	0
Riverside.....	110	104	89	79	93	111	94	93	109	109
Sacramento.....	87	73	82	75	78	83	83	92	110	99
San Benito.....	1	2	1	3	6	1	2	0	1	2
San Bernardino...	146	147	110	145	125	141	163	165	174	161
San Diego.....	125	87	106	97	92	87	129	127	98	126
San Francisco.....	59	58	64	59	62	68	69	88	96	86
San Joaquin.....	73	42	39	39	50	59	58	55	56	57
San Luis Obispo..	5	7	4	3	7	3	7	2	4	6
San Mateo.....	28	23	18	10	18	21	20	26	30	22
Santa Barbara.....	10	11	5	10	12	8	4	7	9	13
Santa Clara.....	62	44	37	34	34	37	48	37	43	37
Santa Cruz.....	4	9	4	9	13	6	13	5	5	16
Shasta.....	7	7	11	3	5	5	5	4	4	8
Sierra.....	0	0	1	0	0	0	1	0	0	0
Siskiyou.....	0	3	0	1	1	4	2	1	4	0
Solano.....	12	14	16	21	10	16	20	19	29	14
Sonoma.....	13	11	8	11	12	16	12	17	5	11
Stanislaus.....	29	25	25	16	34	15	27	42	30	29
Sutter.....	4	1	5	2	5	7	3	3	3	4
Tehama.....	1	5	1	5	3	2	1	3	3	5
Trinity.....	3	0	1	2	0	0	1	1	1	0
Tulare.....	29	22	24	17	26	29	30	25	54	49
Tuolumne.....	0	0	2	2	1	2	4	2	3	0
Ventura.....	25	24	19	24	19	21	42	33	32	29
Yolo.....	7	8	6	6	4	5	5	5	4	4
Yuba.....	6	6	2	3	3	0	5	5	8	3

(continued)

Table 14 - continued
HOMICIDE CRIMES, 1997-2006
 By County
 Number and Rate per 100,000 Population

County	1997	1998	1999	2000	2001	2002	2003	2004	2005	2006
Rate per 100,000 population										
Statewide total.....	7.8	6.5	5.9	6.0	6.3	6.8	6.7	6.5	6.7	6.6
Alameda.....	10.2	7.5	5.9	7.5	7.3	9.7	9.3	7.8	8.3	11.4
Alpine.....	-	-	-	-	-	-	-	-	-	-
Amador.....	-	-	-	-	-	-	-	-	-	-
Butte.....	4.0	3.0	2.0	3.9	5.3	2.4	4.2	2.8	4.6	5.1
Calaveras.....	-	-	-	-	-	-	-	-	-	-
Colusa.....	-	-	-	-	-	-	-	-	-	-
Contra Costa.....	7.0	5.9	6.1	5.8	5.0	4.9	7.4	7.5	7.7	9.0
Del Norte.....	-	-	-	-	-	-	-	-	-	-
El Dorado.....	2.7	4.7	2.0	1.9	3.1	2.4	1.2	1.2	2.8	2.2
Fresno.....	10.8	7.3	5.4	4.7	7.4	7.4	6.9	7.9	8.5	8.1
Glenn.....	-	-	-	-	-	-	-	-	-	-
Humboldt.....	6.3	4.0	9.5	3.1	5.5	9.4	6.2	3.8	2.3	3.8
Imperial.....	3.5	5.6	1.4	2.7	3.3	2.0	7.8	2.5	0.0	1.8
Inyo.....	-	-	-	-	-	-	-	-	-	-
Kern.....	8.7	8.6	8.0	5.5	5.7	7.3	6.4	6.9	8.7	8.2
Kings.....	4.2	4.0	0.8	2.2	0.8	3.0	3.6	4.2	2.7	2.7
Lake.....	-	-	-	-	-	-	-	-	-	-
Lassen.....	-	-	-	-	-	-	-	-	-	-
Los Angeles.....	12.3	9.9	9.1	10.3	11.0	11.7	10.5	10.2	10.4	9.8
Madera.....	5.3	10.5	5.1	7.8	11.5	4.6	5.2	5.0	6.8	1.4
Marin.....	0.4	0.4	0.8	2.0	1.2	1.6	0.0	1.2	1.2	1.2
Mariposa.....	-	-	-	-	-	-	-	-	-	-
Mendocino.....	-	-	-	-	-	-	-	-	-	-
Merced.....	8.4	8.3	6.8	2.8	2.3	8.1	6.9	6.7	8.8	8.8
Modoc.....	-	-	-	-	-	-	-	-	-	-
Mono.....	-	-	-	-	-	-	-	-	-	-
Monterey.....	8.7	7.0	7.4	6.1	6.4	6.8	6.4	7.8	3.3	3.5
Napa.....	1.7	0.8	1.6	2.4	0.8	1.6	1.5	2.3	0.7	1.5
Nevada.....	-	-	-	-	-	-	-	-	2.0	-
Orange.....	3.8	3.1	3.3	1.9	2.2	2.6	2.1	2.7	2.5	2.6

(continued)

Table 14 - continued
HOMICIDE CRIMES, 1997-2006
 By County
 Number and Rate per 100,000 Population

County	1997	1998	1999	2000	2001	2002	2003	2004	2005	2006
Rate per 100,000 population										
Placer.....	1.4	3.1	0.4	2.0	1.1	0.0	3.5	1.0	1.6	1.9
Plumas.....	-	-	-	-	-	-	-	-	-	-
Riverside.....	7.7	7.1	5.9	5.0	5.7	6.6	5.3	5.0	5.4	5.4
Sacramento.....	7.6	6.3	6.8	6.0	6.2	6.4	6.2	6.8	7.9	7.1
San Benito.....	-	-	-	-	-	-	-	-	-	-
San Bernardino...	9.0	8.9	6.6	8.3	7.1	7.8	8.7	8.5	8.6	8.0
San Diego.....	4.5	3.1	3.7	3.4	3.2	3.0	4.3	4.2	3.2	4.1
San Francisco.....	7.6	7.3	8.0	7.5	7.9	8.6	8.8	11.1	12.0	10.7
San Joaquin.....	13.5	7.6	6.9	6.8	8.5	9.7	9.3	8.5	8.3	8.5
San Luis Obispo..	2.1	2.9	1.7	1.2	2.8	1.2	2.7	0.8	1.5	2.3
San Mateo.....	3.9	3.2	2.5	1.4	2.5	2.9	2.8	3.6	4.1	3.0
Santa Barbara.....	2.5	2.7	1.2	2.5	3.0	2.0	1.0	1.7	2.1	3.1
Santa Clara.....	3.7	2.6	2.2	2.0	2.0	2.2	2.8	2.1	2.4	2.1
Santa Cruz.....	1.6	3.6	1.6	3.5	5.0	2.3	5.0	1.9	1.9	6.1
Shasta.....	4.3	4.2	6.7	1.8	3.0	2.9	2.8	2.3	2.2	4.4
Sierra.....	-	-	-	-	-	-	-	-	-	-
Siskiyou.....	-	-	-	-	-	-	-	-	-	-
Solano.....	3.2	3.6	4.1	5.2	2.5	3.9	4.8	4.5	6.9	3.3
Sonoma.....	3.0	2.5	1.8	2.4	2.6	3.4	2.5	3.6	1.0	2.3
Stanislaus.....	6.8	5.8	5.7	3.5	7.3	3.1	5.5	8.4	5.8	5.6
Sutter.....	-	-	-	-	-	-	-	-	-	-
Tehama.....	-	-	-	-	-	-	-	-	-	-
Trinity.....	-	-	-	-	-	-	-	-	-	-
Tulare.....	8.1	6.1	6.6	4.5	6.9	7.6	7.6	6.2	12.7	11.5
Tuolumne.....	-	-	-	-	-	-	-	-	-	-
Ventura.....	3.4	3.3	2.5	3.1	2.5	2.7	5.3	4.1	3.9	3.5
Yolo.....	4.5	5.1	3.8	3.5	2.3	2.8	2.7	2.7	2.1	2.1
Yuba.....	-	-	-	-	-	-	-	-	-	-

Notes: Dash indicates that a rate is not computed when a county's population is less than 100,000 in a given year.

Rates are based on annual population estimates provided by the Demographic Research Unit, California Department of Finance.

Rates are calculated using the population for each county shown; therefore, they will not add to the rate calculated for the state.

Table 15
HOMICIDE CRIMES, 1997-2006
 By Season and Month of Incident

Season and month of incident	1997	1998	1999	2000	2001	2002	2003	2004	2005	2006
Number										
Total including unknown...	2,579	2,170	2,006	2,074	2,201	2,392	2,402	2,394	2,503	2,483
Unknown.....	0	0	0	0	0	0	0	0	0	0
Total known.....	2,579	2,170	2,006	2,074	2,201	2,392	2,402	2,394	2,503	2,483
Spring.....	651	517	451	464	528	582	566	616	580	609
March.....	226	197	142	126	159	189	191	204	195	180
April.....	217	156	147	162	176	188	154	199	191	220
May.....	208	164	162	176	193	205	221	213	194	209
Summer.....	678	568	562	597	581	623	652	648	689	683
June.....	212	177	157	205	165	183	197	190	199	220
July.....	232	171	199	185	208	230	233	228	253	240
August.....	234	220	206	207	208	210	222	230	237	223
Fall.....	662	522	516	497	613	638	601	580	629	612
September.....	228	159	171	173	221	253	209	211	183	204
October.....	240	178	174	174	213	181	213	187	233	209
November.....	194	185	171	150	179	204	179	182	213	199
Winter.....	588	563	477	516	479	549	583	550	605	579
December.....	194	207	166	210	168	175	210	193	210	200
January.....	203	199	183	175	171	214	189	197	217	204
February.....	191	157	128	131	140	160	184	160	178	175
Percent based on total known										
Total known.....	100.0	100.0	100.0	100.0	100.0	100.0	100.0	100.0	100.0	100.0
Spring.....	25.2	23.8	22.5	22.4	24.0	24.3	23.6	25.7	23.2	24.5
March.....	8.8	9.1	7.1	6.1	7.2	7.9	8.0	8.5	7.8	7.2
April.....	8.4	7.2	7.3	7.8	8.0	7.9	6.4	8.3	7.6	8.9
May.....	8.1	7.6	8.1	8.5	8.8	8.6	9.2	8.9	7.8	8.4
Summer.....	26.3	26.2	28.0	28.8	26.4	26.0	27.1	27.1	27.5	27.5
June.....	8.2	8.2	7.8	9.9	7.5	7.7	8.2	7.9	8.0	8.9
July.....	9.0	7.9	9.9	8.9	9.5	9.6	9.7	9.5	10.1	9.7
August.....	9.1	10.1	10.3	10.0	9.5	8.8	9.2	9.6	9.5	9.0
Fall.....	25.7	24.1	25.7	24.0	27.9	26.7	25.0	24.2	25.1	24.6
September.....	8.8	7.3	8.5	8.3	10.0	10.6	8.7	8.8	7.3	8.2
October.....	9.3	8.2	8.7	8.4	9.7	7.6	8.9	7.8	9.3	8.4
November.....	7.5	8.5	8.5	7.2	8.1	8.5	7.5	7.6	8.5	8.0
Winter.....	22.8	25.9	23.8	24.9	21.8	23.0	24.3	23.0	24.2	23.3
December.....	7.5	9.5	8.3	10.1	7.6	7.3	8.7	8.1	8.4	8.1
January.....	7.9	9.2	9.1	8.4	7.8	8.9	7.9	8.2	8.7	8.2
February.....	7.4	7.2	6.4	6.3	6.4	6.7	7.7	6.7	7.1	7.0

Note: Percentages may not add to subtotals or 100.0 because of rounding.

Table 16
HOMICIDE CRIMES, 2006
 Gender and Race/Ethnic Group of Victim by Day of Incident

Day of incident	Total	Gender		Race/ethnic group				
		Male	Female	White	Hispanic	Black	Other	Unknown
Number								
Total including unknown....	2,483	2,070	413	432	1,129	736	178	8
Unknown.....	0	0	0	0	0	0	0	0
Total known.....	2,483	2,070	413	432	1,129	736	178	8
Weekday.....	1,520	1,241	279	288	642	476	111	3
Monday.....	345	278	67	63	144	109	27	2
Tuesday.....	284	215	69	60	110	93	21	0
Wednesday.....	290	241	49	56	124	90	20	0
Thursday.....	276	241	35	50	114	95	17	0
Friday.....	325	266	59	59	150	89	26	1
Weekend.....	963	829	134	144	487	260	67	5
Saturday.....	479	412	67	68	239	131	37	4
Sunday.....	484	417	67	76	248	129	30	1
Percent based on total known								
Total known.....	100.0	100.0	100.0	100.0	100.0	100.0	100.0	100.0
Weekday.....	61.2	60.0	67.6	66.7	56.9	64.7	62.4	-
Monday.....	13.9	13.4	16.2	14.6	12.8	14.8	15.2	-
Tuesday.....	11.4	10.4	16.7	13.9	9.7	12.6	11.8	-
Wednesday.....	11.7	11.6	11.9	13.0	11.0	12.2	11.2	-
Thursday.....	11.1	11.6	8.5	11.6	10.1	12.9	9.6	-
Friday.....	13.1	12.9	14.3	13.7	13.3	12.1	14.6	-
Weekend.....	38.8	40.0	32.4	33.3	43.1	35.3	37.6	-
Saturday.....	19.3	19.9	16.2	15.7	21.2	17.8	20.8	-
Sunday.....	19.5	20.1	16.2	17.6	22.0	17.5	16.9	-
Average daily number of incidents ¹								
Weekday.....	5.9	4.8	1.1	1.1	2.5	1.8	0.4	0.0
Weekend.....	9.1	7.8	1.3	1.4	4.6	2.5	0.6	0.0

Notes: Percentages may not add to subtotals or 100.0 because of rounding.

Dash indicates that percent distributions are not calculated when the base number is less than 50.

Average daily number of incidents may not add to totals because of rounding.

¹ There were 365 days in 2006; 259 weekdays and 106 weekend days. The average daily number of incidents for weekdays was calculated by dividing weekday totals by 259. The average daily number of incidents for weekends was calculated by dividing weekend totals by 106.

Table 17
HOMICIDE CRIMES, 2006
 Age of Victim by Day of Incident

Day of incident	Total	Under 18	18-29	30-39	40 and over	Unknown
Number						
Total including unknown.....	2,483	316	1,147	418	586	16
Unknown.....	0	0	0	0	0	0
Total known.....	2,483	316	1,147	418	586	16
Weekday.....	1,520	200	675	259	379	7
Monday.....	345	51	153	48	89	4
Tuesday.....	284	37	121	52	73	1
Wednesday.....	290	40	118	50	82	0
Thursday.....	276	29	120	64	63	0
Friday.....	325	43	163	45	72	2
Weekend.....	963	116	472	159	207	9
Saturday.....	479	54	242	77	100	6
Sunday.....	484	62	230	82	107	3
Percent based on total known						
Total known.....	100.0	100.0	100.0	100.0	100.0	100.0
Weekday.....	61.2	63.3	58.8	62.0	64.7	-
Monday.....	13.9	16.1	13.3	11.5	15.2	-
Tuesday.....	11.4	11.7	10.5	12.4	12.5	-
Wednesday.....	11.7	12.7	10.3	12.0	14.0	-
Thursday.....	11.1	9.2	10.5	15.3	10.8	-
Friday.....	13.1	13.6	14.2	10.8	12.3	-
Weekend.....	38.8	36.7	41.2	38.0	35.3	-
Saturday.....	19.3	17.1	21.1	18.4	17.1	-
Sunday.....	19.5	19.6	20.1	19.6	18.3	-
Average daily number of incidents ¹						
Weekday.....	5.9	0.8	2.6	1.0	1.5	0.0
Weekend.....	9.1	1.1	4.5	1.5	2.0	0.1

Notes: Percentages may not add to subtotals or 100.0 because of rounding.

Dash indicates that percent distributions are not calculated when the base number is less than 50.

Average daily number of incidents may not add to totals because of rounding.

¹ There were 365 days in 2006; 259 weekdays and 106 weekend days. The average daily number of incidents for weekdays was calculated by dividing weekday totals by 259. The average daily number of incidents for weekends was calculated by dividing weekend totals by 106.

Table 18
HOMICIDE CRIMES, 1997-2006
 By Location of Homicide

Location of homicide	1997		1998		1999		2000		2001	
	Number	Percent	Number	Percent	Number	Percent	Number	Percent	Number	Percent
Total including unknown.....	2,579		2,170		2,006		2,074		2,201	
Unknown.....	1		2		4		4		0	
Total known.....	2,578	100.0	2,168	100.0	2,002	100.0	2,070	100.0	2,201	100.0
Victim's, shared residence...	746	28.9	629	29.0	686	34.3	612	29.6	573	26.0
Victim's residence.....	487	18.9	404	18.6	520	26.0	439	21.2	417	18.9
Shared residence.....	259	10.0	225	10.4	166	8.3	173	8.4	156	7.1
Street, sidewalk.....	994	38.6	823	38.0	710	35.5	779	37.6	845	38.4
All other.....	838	32.5	716	33.0	606	30.3	679	32.8	783	35.6
Hotel, motel.....	17	0.7	26	1.2	28	1.4	23	1.1	28	1.3
Other residence.....	175	6.8	132	6.1	119	5.9	162	7.8	173	7.9
Liquor store.....	5	0.2	4	0.2	5	0.2	4	0.2	7	0.3
Bar.....	29	1.1	32	1.5	35	1.7	37	1.8	44	2.0
Other business.....	90	3.5	84	3.9	54	2.7	76	3.7	61	2.8
Parking lot.....	77	3.0	68	3.1	59	2.9	72	3.5	75	3.4
Vehicle.....	226	8.8	182	8.4	139	6.9	156	7.5	196	8.9
Field, park.....	191	7.4	157	7.2	129	6.4	120	5.8	167	7.6
School.....	5	0.2	9	0.4	5	0.2	2	0.1	3	0.1
Other.....	23	0.9	22	1.0	33	1.6	27	1.3	29	1.3

Location of homicide (cont.)	2002		2003		2004		2005		2006		Percent change	
	Number	Percent	Number	Percent	Number	Percent	Number	Percent	Number	Percent	1997-2006	2005-2006
Total including unknown.....	2,392		2,402		2,394		2,503		2,483			
Unknown.....	2		0		13		25		19			
Total known.....	2,390	100.0	2,402	100.0	2,381	100.0	2,478	100.0	2,464	100.0	-4.4	-0.6
Victim's, shared residence...	655	27.4	623	25.9	630	26.5	567	22.9	548	22.2	-26.5	-3.4
Victim's residence.....	465	19.5	425	17.7	479	20.1	414	16.7	397	16.1	-18.5	-4.1
Shared residence.....	190	7.9	198	8.2	151	6.3	153	6.2	151	6.1	-41.7	-1.3
Street, sidewalk.....	970	40.6	909	37.8	1,046	43.9	1,116	45.0	1,097	44.5	10.4	-1.7
All other.....	765	32.0	870	36.2	705	29.6	795	32.1	819	33.2	-2.3	3.0
Hotel, motel.....	26	1.1	26	1.1	20	0.8	23	0.9	22	0.9	-	-
Other residence.....	147	6.2	173	7.2	146	6.1	138	5.6	167	6.8	-4.6	21.0
Liquor store.....	4	0.2	6	0.2	9	0.4	6	0.2	5	0.2	-	-
Bar.....	40	1.7	38	1.6	35	1.5	34	1.4	41	1.7	-	-
Other business.....	61	2.6	75	3.1	47	2.0	70	2.8	61	2.5	-32.2	-12.9
Parking lot.....	87	3.6	98	4.1	74	3.1	97	3.9	104	4.2	35.1	7.2
Vehicle.....	228	9.5	274	11.4	240	10.1	282	11.4	296	12.0	31.0	5.0
Field, park.....	134	5.6	147	6.1	102	4.3	94	3.8	92	3.7	-51.8	-2.1
School.....	1	0.0	3	0.1	4	0.2	4	0.2	3	0.1	-	-
Other.....	37	1.5	30	1.2	28	1.2	47	1.9	28	1.1	-	-

Notes: Percentages may not add to subtotals or 100.0 because of rounding.

Dash indicates that a percent change is not calculated when the base number is less than 50.

Table 19
HOMICIDE CRIMES, 2006
 Gender and Race/Ethnic Group of Victim by Location of Homicide

Location of homicide	Total	Gender		Race/ethnic group				
		Male	Female	White	Hispanic	Black	Other	Unknown
Number								
Total including unknown.....	2,483	2,070	413	432	1,129	736	178	8
Unknown.....	19	12	7	8	6	4	1	0
Total known.....	2,464	2,058	406	424	1,123	732	177	8
Victim's, shared residence...	548	340	208	191	192	117	48	0
Victim's residence.....	397	276	121	128	142	92	35	0
Shared residence.....	151	64	87	63	50	25	13	0
Street, sidewalk.....	1,097	1,010	87	103	554	384	54	2
All other.....	819	708	111	130	377	231	75	6
Hotel, motel.....	22	15	7	6	9	7	0	0
Other residence.....	167	150	17	34	84	38	10	1
Liquor store.....	5	4	1	1	1	0	3	0
Bar.....	41	36	5	5	20	6	10	0
Other business.....	61	49	12	15	23	13	10	0
Parking lot.....	104	98	6	10	51	36	6	1
Vehicle.....	296	257	39	19	147	107	22	1
Field, park.....	92	72	20	30	31	17	11	3
School.....	3	3	0	0	1	1	1	0
Other.....	28	24	4	10	10	6	2	0
Percent based on total known								
Total known.....	100.0	100.0	100.0	100.0	100.0	100.0	100.0	100.0
Victim's, shared residence...	22.2	16.5	51.2	45.0	17.1	16.0	27.1	-
Victim's residence.....	16.1	13.4	29.8	30.2	12.6	12.6	19.8	-
Shared residence.....	6.1	3.1	21.4	14.9	4.5	3.4	7.3	-
Street, sidewalk.....	44.5	49.1	21.4	24.3	49.3	52.5	30.5	-
All other.....	33.2	34.4	27.3	30.7	33.6	31.6	42.4	-
Hotel, motel.....	0.9	0.7	1.7	1.4	0.8	1.0	0.0	-
Other residence.....	6.8	7.3	4.2	8.0	7.5	5.2	5.6	-
Liquor store.....	0.2	0.2	0.2	0.2	0.1	0.0	1.7	-
Bar.....	1.7	1.7	1.2	1.2	1.8	0.8	5.6	-
Other business.....	2.5	2.4	3.0	3.5	2.0	1.8	5.6	-
Parking lot.....	4.2	4.8	1.5	2.4	4.5	4.9	3.4	-
Vehicle.....	12.0	12.5	9.6	4.5	13.1	14.6	12.4	-
Field, park.....	3.7	3.5	4.9	7.1	2.8	2.3	6.2	-
School.....	0.1	0.1	0.0	0.0	0.1	0.1	0.6	-
Other.....	1.1	1.2	1.0	2.4	0.9	0.8	1.1	-

Notes: Percentages may not add to subtotals or 100.0 because of rounding.

Dash indicates that percent distributions are not calculated when the base number is less than 50.

Table 20
HOMICIDE CRIMES, 2006
 Age of Victim by Location of Homicide

Location of homicide	Total	Under 18	18-29	30-39	40 and over	Unknown
Number						
Total including unknown.....	2,483	316	1,147	418	586	16
Unknown.....	19	0	8	4	7	0
Total known.....	2,464	316	1,139	414	579	16
Victim's, shared residence....	548	94	131	91	230	2
Victim's residence.....	397	51	108	72	166	0
Shared residence.....	151	43	23	19	64	2
Street, sidewalk.....	1,097	155	594	171	173	4
All other.....	819	67	414	152	176	10
Hotel, motel.....	22	5	4	5	8	0
Other residence.....	167	23	93	24	27	0
Liquor store.....	5	2	2	0	1	0
Bar.....	41	0	19	9	13	0
Other business.....	61	0	19	11	31	0
Parking lot.....	104	4	57	24	17	2
Vehicle.....	296	23	177	50	42	4
Field, park.....	92	7	36	18	27	4
School.....	3	2	1	0	0	0
Other.....	28	1	6	11	10	0
Percent based on total known						
Total known.....	100.0	100.0	100.0	100.0	100.0	100.0
Victim's, shared residence....	22.2	29.7	11.5	22.0	39.7	-
Victim's residence.....	16.1	16.1	9.5	17.4	28.7	-
Shared residence.....	6.1	13.6	2.0	4.6	11.1	-
Street, sidewalk.....	44.5	49.1	52.2	41.3	29.9	-
All other.....	33.2	21.2	36.3	36.7	30.4	-
Hotel, motel.....	0.9	1.6	0.4	1.2	1.4	-
Other residence.....	6.8	7.3	8.2	5.8	4.7	-
Liquor store.....	0.2	0.6	0.2	0.0	0.2	-
Bar.....	1.7	0.0	1.7	2.2	2.2	-
Other business.....	2.5	0.0	1.7	2.7	5.4	-
Parking lot.....	4.2	1.3	5.0	5.8	2.9	-
Vehicle.....	12.0	7.3	15.5	12.1	7.3	-
Field, park.....	3.7	2.2	3.2	4.3	4.7	-
School.....	0.1	0.6	0.1	0.0	0.0	-
Other.....	1.1	0.3	0.5	2.7	1.7	-

Notes: Percentages may not add to subtotals or 100.0 because of rounding.

Dash indicates that percent distributions are not calculated when the base number is less than 50.

Table 21
HOMICIDE CRIMES, 1997-2006
 By Type of Weapon Used

Type of weapon used	1997		1998		1999		2000		2001	
	Number	Percent	Number	Percent	Number	Percent	Number	Percent	Number	Percent
Total including unknown.....	2,579		2,170		2,006		2,074		2,201	
Unknown.....	40		36		29		28		28	
Total known.....	2,539	100.0	2,134	100.0	1,977	100.0	2,046	100.0	2,173	100.0
Firearm.....	1,835	72.3	1,469	68.8	1,334	67.5	1,440	70.4	1,568	72.2
Handgun.....	1,633	64.3	1,315	61.6	1,152	58.3	1,242	60.7	1,341	61.7
All other firearms.....	202	8.0	154	7.2	182	9.2	198	9.7	227	10.4
Rifle.....	115	4.5	89	4.2	62	3.1	66	3.2	67	3.1
Shotgun.....	72	2.8	57	2.7	63	3.2	55	2.7	68	3.1
Other firearm.....	0	0.0	0	0.0	0	0.0	1	0.0	2	0.1
Firearm - unknown type..	15	0.6	8	0.4	57	2.9	76	3.7	90	4.1
Nonfirearm.....	704	27.7	665	31.2	643	32.5	606	29.6	605	27.8
Knife ¹	307	12.1	289	13.5	254	12.8	285	13.9	298	13.7
Blunt object ²	108	4.3	117	5.5	134	6.8	98	4.8	95	4.4
Personal weapon ³	148	5.8	112	5.2	106	5.4	111	5.4	103	4.7
All other.....	141	5.6	147	6.9	149	7.5	112	5.5	109	5.0
Rope ⁴	56	2.2	63	3.0	60	3.0	40	2.0	37	1.7
Drugs.....	6	0.2	2	0.1	8	0.4	3	0.1	4	0.2
Other.....	79	3.1	82	3.8	81	4.1	69	3.4	68	3.1

Type of weapon used (cont.)	2002		2003		2004		2005		2006		Percent change	
	Number	Percent	Number	Percent	Number	Percent	Number	Percent	Number	Percent	1997-2006	2005-2006
Total including unknown.....	2,392		2,402		2,394		2,503		2,483			
Unknown.....	28		23		12		22		25			
Total known.....	2,364	100.0	2,379	100.0	2,382	100.0	2,481	100.0	2,458	100.0	-3.2	-0.9
Firearm.....	1,735	73.4	1,733	72.8	1,730	72.6	1,845	74.4	1,821	74.1	-0.8	-1.3
Handgun.....	1,555	65.8	1,566	65.8	1,462	61.4	1,547	62.4	1,619	65.9	-0.9	4.7
All other firearms.....	180	7.6	167	7.0	268	11.3	298	12.0	202	8.2	0.0	-32.2
Rifle.....	80	3.4	62	2.6	73	3.1	87	3.5	74	3.0	-35.7	-14.9
Shotgun.....	60	2.5	53	2.2	69	2.9	75	3.0	70	2.8	-2.8	-6.7
Other firearm.....	2	0.1	3	0.1	3	0.1	0	0.0	0	0.0	-	-
Firearm - unknown type..	38	1.6	49	2.1	123	5.2	136	5.5	58	2.4	-	-57.4
Nonfirearm.....	629	26.6	646	27.2	652	27.4	636	25.6	637	25.9	-9.5	0.2
Knife ¹	274	11.6	258	10.8	282	11.8	291	11.7	314	12.8	2.3	7.9
Blunt object ²	116	4.9	116	4.9	104	4.4	78	3.1	77	3.1	-28.7	-1.3
Personal weapon ³	118	5.0	138	5.8	148	6.2	138	5.6	130	5.3	-12.2	-5.8
All other.....	121	5.1	134	5.6	118	5.0	129	5.2	116	4.7	-17.7	-10.1
Rope ⁴	41	1.7	58	2.4	49	2.1	30	1.2	33	1.3	-41.1	-
Drugs.....	5	0.2	2	0.1	5	0.2	2	0.1	5	0.2	-	-
Other.....	75	3.2	74	3.1	64	2.7	97	3.9	78	3.2	-1.3	-19.6

Notes: Percentages may not add to subtotals or 100.0 because of rounding.

Dash indicates that a percent change is not calculated when the base number is less than 50.

¹ Any instrument used to cut or stab.

² Club, etc.

³ Hands, feet, etc.

⁴ Any instrument used to hang or strangle.

Table 22
HOMICIDE CRIMES, 2006
 Gender and Race/Ethnic Group of Victim by Type of Weapon Used

Type of weapon used	Total	Gender		Race/ethnic group				
		Male	Female	White	Hispanic	Black	Other	Unknown
Number								
Total including unknown.....	2,483	2,070	413	432	1,129	736	178	8
Unknown.....	25	7	18	12	8	3	0	2
Total known.....	2,458	2,063	395	420	1,121	733	178	6
Firearm.....	1,821	1,608	213	197	862	624	135	3
Handgun.....	1,619	1,433	186	159	774	567	117	2
All other firearms.....	202	175	27	38	88	57	18	1
Rifle.....	74	64	10	17	25	26	6	0
Shotgun.....	70	61	9	18	33	13	6	0
Other firearm.....	0	0	0	0	0	0	0	0
Firearm - unknown type..	58	50	8	3	30	18	6	1
Nonfirearm.....	637	455	182	223	259	109	43	3
Knife ¹	314	250	64	95	143	56	19	1
Blunt object ²	77	55	22	32	27	15	3	0
Personal weapon ³	130	94	36	44	55	26	5	0
All other.....	116	56	60	52	34	12	16	2
Rope ⁴	33	8	25	19	9	4	1	0
Drugs.....	5	2	3	3	1	0	1	0
Other.....	78	46	32	30	24	8	14	2
Percent based on total known								
Total known.....	100.0	100.0	100.0	100.0	100.0	100.0	100.0	100.0
Firearm.....	74.1	77.9	53.9	46.9	76.9	85.1	75.8	-
Handgun.....	65.9	69.5	47.1	37.9	69.0	77.4	65.7	-
All other firearms.....	8.2	8.5	6.8	9.0	7.9	7.8	10.1	-
Rifle.....	3.0	3.1	2.5	4.0	2.2	3.5	3.4	-
Shotgun.....	2.8	3.0	2.3	4.3	2.9	1.8	3.4	-
Other firearm.....	0.0	0.0	0.0	0.0	0.0	0.0	0.0	-
Firearm - unknown type..	2.4	2.4	2.0	0.7	2.7	2.5	3.4	-
Nonfirearm.....	25.9	22.1	46.1	53.1	23.1	14.9	24.2	-
Knife ¹	12.8	12.1	16.2	22.6	12.8	7.6	10.7	-
Blunt object ²	3.1	2.7	5.6	7.6	2.4	2.0	1.7	-
Personal weapon ³	5.3	4.6	9.1	10.5	4.9	3.5	2.8	-
All other.....	4.7	2.7	15.2	12.4	3.0	1.6	9.0	-
Rope ⁴	1.3	0.4	6.3	4.5	0.8	0.5	0.6	-
Drugs.....	0.2	0.1	0.8	0.7	0.1	0.0	0.6	-
Other.....	3.2	2.2	8.1	7.1	2.1	1.1	7.9	-

Notes: Percentages may not add to subtotals or 100.0 because of rounding.

Dash indicates that percent distributions are not calculated when the base number is less than 50.

¹ Any instrument used to cut or stab.

² Club, etc.

³ Hands, feet, etc.

⁴ Any instrument used to hang or strangle.

Table 23
HOMICIDE CRIMES, 2006
 Age of Victim by Type of Weapon Used

Type of weapon used	Total	Under 18	18-29	30-39	40 and over	Unknown
Number						
Total including unknown.....	2,483	316	1,147	418	586	16
Unknown.....	25	1	5	6	12	1
Total known.....	2,458	315	1,142	412	574	15
Firearm.....	1,821	215	970	317	312	7
Handgun.....	1,619	190	870	286	268	5
All other firearms.....	202	25	100	31	44	2
Rifle.....	74	14	39	7	13	1
Shotgun.....	70	7	33	12	18	0
Other firearm.....	0	0	0	0	0	0
Firearm - unknown type..	58	4	28	12	13	1
Nonfirearm.....	637	100	172	95	262	8
Knife ¹	314	18	113	54	124	5
Blunt object ²	77	7	15	10	44	1
Personal weapon ³	130	45	16	16	53	0
All other.....	116	30	28	15	41	2
Rope ⁴	33	5	7	7	14	0
Drugs.....	5	2	0	1	2	0
Other.....	78	23	21	7	25	2
Percent based on total known						
Total known.....	100.0	100.0	100.0	100.0	100.0	100.0
Firearm.....	74.1	68.3	84.9	76.9	54.4	-
Handgun.....	65.9	60.3	76.2	69.4	46.7	-
All other firearms.....	8.2	7.9	8.8	7.5	7.7	-
Rifle.....	3.0	4.4	3.4	1.7	2.3	-
Shotgun.....	2.8	2.2	2.9	2.9	3.1	-
Other firearm.....	0.0	0.0	0.0	0.0	0.0	-
Firearm - unknown type..	2.4	1.3	2.5	2.9	2.3	-
Nonfirearm.....	25.9	31.7	15.1	23.1	45.6	-
Knife ¹	12.8	5.7	9.9	13.1	21.6	-
Blunt object ²	3.1	2.2	1.3	2.4	7.7	-
Personal weapon ³	5.3	14.3	1.4	3.9	9.2	-
All other.....	4.7	9.5	2.5	3.6	7.1	-
Rope ⁴	1.3	1.6	0.6	1.7	2.4	-
Drugs.....	0.2	0.6	0.0	0.2	0.3	-
Other.....	3.2	7.3	1.8	1.7	4.4	-

Notes: Percentages may not add to subtotals or 100.0 because of rounding.

Dash indicates that percent distributions are not calculated when the base number is less than 50.

¹ Any instrument used to cut or stab.

² Club, etc.

³ Hands, feet, etc.

⁴ Any instrument used to hang or strangle.

Table 24
HOMICIDE CRIMES, 1997-2006
 By Contributing Circumstance

Contributing circumstance	1997		1998		1999		2000		2001	
	Number	Percent	Number	Percent	Number	Percent	Number	Percent	Number	Percent
Total including unknown.....	2,579		2,170		2,006		2,074		2,201	
Unknown.....	424		336		304		314		317	
Total known.....	2,155	100.0	1,834	100.0	1,702	100.0	1,760	100.0	1,884	100.0
Rape, robbery, burglary...	240	11.1	206	11.2	157	9.2	206	11.7	149	7.9
Rape.....	12	0.6	9	0.5	16	0.9	8	0.5	12	0.6
Robbery.....	219	10.2	183	10.0	127	7.5	186	10.6	133	7.1
Burglary.....	9	0.4	14	0.8	14	0.8	12	0.7	4	0.2
Argument.....	928	43.1	857	46.7	710	41.7	726	41.3	793	42.1
Domestic violence ¹	128	5.9	120	6.5	128	7.5	147	8.4	176	9.3
All other argument.....	800	37.1	737	40.2	582	34.2	579	32.9	617	32.7
Gang-, drug-related.....	704	32.7	512	27.9	487	28.6	581	33.0	726	38.5
Gang-related.....	544	25.2	404	22.0	402	23.6	506	28.8	647	34.3
Drug-related.....	160	7.4	108	5.9	85	5.0	75	4.3	79	4.2
All other.....	283	13.1	259	14.1	348	20.4	247	14.0	216	11.5

Contributing circumstance (cont.)	2002		2003		2004		2005		2006		Percent change	
	Number	Percent	Number	Percent	Number	Percent	Number	Percent	Number	Percent	1997-2006	2005-2006
Total including unknown.....	2,392		2,402		2,394		2,503		2,483			
Unknown.....	370		410		320		526		568			
Total known.....	2,022	100.0	1,992	100.0	2,074	100.0	1,977	100.0	1,915	100.0	-11.1	-3.1
Rape, robbery, burglary...	179	8.9	161	8.1	145	7.0	151	7.6	141	7.4	-41.3	-6.6
Rape.....	8	0.4	7	0.4	6	0.3	7	0.4	6	0.3	-	-
Robbery.....	163	8.1	137	6.9	128	6.2	135	6.8	132	6.9	-39.7	-2.2
Burglary.....	8	0.4	17	0.9	11	0.5	9	0.5	3	0.2	-	-
Argument.....	779	38.5	836	42.0	886	42.7	791	40.0	741	38.7	-20.2	-6.3
Domestic violence ¹	181	9.0	187	9.4	163	7.9	160	8.1	141	7.4	10.2	-11.9
All other argument.....	598	29.6	649	32.6	723	34.9	631	31.9	600	31.3	-25.0	-4.9
Gang-, drug-related.....	816	40.4	772	38.8	786	37.9	756	38.2	748	39.1	6.3	-1.1
Gang-related.....	730	36.1	669	33.6	698	33.7	653	33.0	645	33.7	18.6	-1.2
Drug-related.....	86	4.3	103	5.2	88	4.2	103	5.2	103	5.4	-35.6	0.0
All other.....	248	12.3	223	11.2	257	12.4	279	14.1	285	14.9	0.7	2.2

Notes: Percentages may not add to subtotals or 100.0 because of rounding.

Dash indicates that a percent change is not calculated when the base number is less than 50.

¹ Data reflect 1) homicides submitted to the CJSC from law enforcement agencies as domestic violence-related, and 2) homicides interpreted by the CJSC as domestic violence-related based on available information, including victim/offender relationship.

Table 25
HOMICIDE CRIMES, 2006
 Gender and Race/Ethnic Group of Victim by Contributing Circumstance

Contributing circumstance	Total	Gender		Race/ethnic group				
		Male	Female	White	Hispanic	Black	Other	Unknown
Number								
Total including unknown.....	2,483	2,070	413	432	1,129	736	178	8
Unknown.....	568	479	89	84	231	221	24	8
Total known.....	1,915	1,591	324	348	898	515	154	0
Rape, robbery, burglary..	141	121	20	47	41	29	24	0
Rape.....	6	0	6	3	0	2	1	0
Robbery, burglary.....	135	121	14	44	41	27	23	0
Robbery.....	132	119	13	42	41	26	23	0
Burglary.....	3	2	1	2	0	1	0	0
Argument.....	741	547	194	183	310	194	54	0
Domestic violence ¹	141	26	115	59	44	25	13	0
All other argument.....	600	521	79	124	266	169	41	0
Gang-, drug-related.....	748	717	31	52	429	214	53	0
Gang-related.....	645	619	26	39	393	174	39	0
Drug-related.....	103	98	5	13	36	40	14	0
All other.....	285	206	79	66	118	78	23	0
Percent based on total known								
Total known.....	100.0	100.0	100.0	100.0	100.0	100.0	100.0	100.0
Rape, robbery, burglary..	7.4	7.6	6.2	13.5	4.6	5.6	15.6	-
Rape.....	0.3	0.0	1.9	0.9	0.0	0.4	0.6	-
Robbery, burglary.....	7.0	7.6	4.3	12.6	4.6	5.2	14.9	-
Robbery.....	6.9	7.5	4.0	12.1	4.6	5.0	14.9	-
Burglary.....	0.2	0.1	0.3	0.6	0.0	0.2	0.0	-
Argument.....	38.7	34.4	59.9	52.6	34.5	37.7	35.1	-
Domestic violence ¹	7.4	1.6	35.5	17.0	4.9	4.9	8.4	-
All other argument.....	31.3	32.7	24.4	35.6	29.6	32.8	26.6	-
Gang-, drug-related.....	39.1	45.1	9.6	14.9	47.8	41.6	34.4	-
Gang-related.....	33.7	38.9	8.0	11.2	43.8	33.8	25.3	-
Drug-related.....	5.4	6.2	1.5	3.7	4.0	7.8	9.1	-
All other.....	14.9	12.9	24.4	19.0	13.1	15.1	14.9	-

Notes: Percentages may not add to subtotals or 100.0 because of rounding.

Dash indicates that percent distributions are not calculated when the base number is less than 50.

¹ Data reflect (1) homicides submitted to the CJSC from law enforcement agencies as domestic violence-related, and (2) homicides interpreted by the CJSC as domestic violence-related based on available information, including victim/offender relationship.

Table 26
HOMICIDE CRIMES, 2006
 Age of Victim by Contributing Circumstance

Contributing circumstance	Total	Under 5	5-17	18-29	30-39	40-49	50-59	60-69	70 and over	Unknown
Number										
Total including unknown.....	2,483	71	245	1,147	418	300	173	59	54	16
Unknown.....	568	3	32	263	110	75	51	18	5	11
Total known.....	1,915	68	213	884	308	225	122	41	49	5
Rape, robbery, burglary..	141	0	6	45	30	22	17	9	12	0
Rape.....	6	0	1	2	1	1	0	0	1	0
Robbery.....	132	0	4	43	29	20	16	9	11	0
Burglary.....	3	0	1	0	0	1	1	0	0	0
Argument.....	741	0	40	312	144	121	74	25	23	2
Domestic violence ¹	141	0	2	41	33	32	18	3	11	1
All other argument.....	600	0	38	271	111	89	56	22	12	1
Gang-, drug-related.....	748	1	125	435	110	57	14	3	2	1
Gang-related.....	645	1	118	390	80	42	10	2	1	1
Drug-related.....	103	0	7	45	30	15	4	1	1	0
Child abuse.....	66	60	6	-	-	-	-	-	-	0
All other.....	219	7	36	92	24	25	17	4	12	2
Percent based on total known										
Total known.....	100.0	100.0	100.0	100.0	100.0	100.0	100.0	100.0	100.0	100.0
Rape, robbery, burglary..	7.4	0.0	2.8	5.1	9.7	9.8	13.9	-	-	-
Rape.....	0.3	0.0	0.5	0.2	0.3	0.4	0.0	-	-	-
Robbery.....	6.9	0.0	1.9	4.9	9.4	8.9	13.1	-	-	-
Burglary.....	0.2	0.0	0.5	0.0	0.0	0.4	0.8	-	-	-
Argument.....	38.7	0.0	18.8	35.3	46.8	53.8	60.7	-	-	-
Domestic violence ¹	7.4	0.0	0.9	4.6	10.7	14.2	14.8	-	-	-
All other argument.....	31.3	0.0	17.8	30.7	36.0	39.6	45.9	-	-	-
Gang-, drug-related.....	39.1	1.5	58.7	49.2	35.7	25.3	11.5	-	-	-
Gang-related.....	33.7	1.5	55.4	44.1	26.0	18.7	8.2	-	-	-
Drug-related.....	5.4	0.0	3.3	5.1	9.7	6.7	3.3	-	-	-
Child abuse.....	3.4	88.2	2.8	-	-	-	-	-	-	-
All other.....	11.4	10.3	16.9	10.4	7.8	11.1	13.9	-	-	-

Notes: Percentages may not add to subtotals or 100.0 because of rounding.

Dash indicates that data are not applicable or that percent distributions are not calculated when the base number is less than 50.

¹ Data reflect 1) homicides submitted to the CJSC from law enforcement agencies as domestic violence-related, and 2) homicides interpreted by the CJSC as domestic violence-related based on available information, including victim/offender relationship.

Table 27
HOMICIDE CRIMES, 2006
 Contributing Circumstance by Relationship of Victim to Offender

Relationship of victim to offender	Total	Rape	Robbery, burglary	Argument ¹	Gang-, drug-related	Child abuse	All other	Unknown
Number								
Total including unknown.....	2,483	6	135	741	748	66	219	568
Unknown.....	1,109	3	45	114	384	5	99	459
Total known.....	1,374	3	90	627	364	61	120	109
Friend, acquaintance ²	593	3	11	305	182	19	41	32
Spouse ³	86	0	0	83	0	0	3	0
Parent, child ⁴	94	0	1	29	1	38	20	5
All other relatives.....	43	0	0	32	3	3	4	1
Stranger.....	558	0	78	178	178	1	52	71
Percent based on total known								
Total known.....	100.0	100.0	100.0	100.0	100.0	100.0	100.0	100.0
Friend, acquaintance ²	43.2	-	12.2	48.6	50.0	31.1	34.2	29.4
Spouse ³	6.3	-	0.0	13.2	0.0	0.0	2.5	0.0
Parent, child ⁴	6.8	-	1.1	4.6	0.3	62.3	16.7	4.6
All other relatives.....	3.1	-	0.0	5.1	0.8	4.9	3.3	0.9
Stranger.....	40.6	-	86.7	28.4	48.9	1.6	43.3	65.1

Notes: Percentages may not add to 100.0 because of rounding.

Dash indicates that percent distributions are not calculated when the base number is less than 50.

¹ Includes domestic violence.

² Includes ex-husband, ex-wife, employer, employee, gang member, etc.

³ Includes "common-law" marriage partner.

⁴ Includes stepmother, stepfather, stepdaughter, and stepson.

Table 28
HOMICIDE CRIMES CLEARED, 1997-2006
 Number Reported, Number Cleared, and Clearance Rate

Year(s)	Number of homicides reported	Number of homicides cleared	Clearance rate ¹
2006.....	2,483	1,292	52.0
2005.....	2,503	1,249	49.9
2004.....	2,394	1,314	54.9
2003.....	2,402	1,323	55.1
2002.....	2,392	1,362	56.9
2001.....	2,201	1,091	49.6
2000.....	2,074	1,082	52.2
1999.....	2,006	1,200	59.8
1998.....	2,170	1,369	63.1
1997.....	2,579	1,489	57.7

¹ A clearance rate is the percentage of crimes (homicides) reported that have been cleared. It is calculated by dividing the number of homicides cleared by the number of homicides reported. The result is multiplied by 100. Please see "Appendix II - Criminal Justice Glossary" for a detailed explanation of clearances.

Table 29
**FELONY ARRESTS FOR
 SELECTED VIOLENT OFFENSES, 1997-2006**
 Number, Rate per 100,000 Population at Risk, and Percent Change

Year(s)	Total	Homicide	Forcible rape	Robbery	Assault
Number					
2006.....	124,624	1,967	2,122	20,376	100,159
2005.....	123,967	1,956	2,098	18,218	101,695
2004.....	125,263	1,978	2,237	17,864	103,184
2003.....	129,522	1,839	2,456	17,501	107,726
2002.....	130,295	1,864	2,549	16,957	108,925
2001.....	134,398	1,754	2,730	17,167	112,747
2000.....	130,259	1,627	2,702	17,122	108,808
1999.....	134,319	1,770	2,887	18,753	110,909
1998.....	142,498	2,117	3,032	21,507	115,842
1997.....	153,279	2,212	3,108	23,824	124,135
Percent change in number					
2005 to 2006.....	0.5	0.6	1.1	11.8	-1.5
2004 to 2005.....	-1.0	-1.1	-6.2	2.0	-1.4
2003 to 2004.....	-3.3	7.6	-8.9	2.1	-4.2
2002 to 2003.....	-0.6	-1.3	-3.6	3.2	-1.1
2001 to 2002.....	-3.1	6.3	-6.6	-1.2	-3.4
2000 to 2001.....	3.2	7.8	1.0	0.3	3.6
1999 to 2000.....	-3.0	-8.1	-6.4	-8.7	-1.9
1998 to 1999.....	-5.7	-16.4	-4.8	-12.8	-4.3
1997 to 1998.....	-7.0	-4.3	-2.4	-9.7	-6.7
1997 to 2006.....	-18.7	-11.1	-31.7	-14.5	-19.3
Rate per 100,000 population at risk ¹					
2006.....	426.3	6.7	7.3	69.7	342.6
2005.....	430.3	6.8	7.3	63.2	353.0
2004.....	441.7	7.0	7.9	63.0	363.9
2003.....	465.6	6.6	8.8	62.9	387.3
2002.....	477.2	6.8	9.3	62.1	399.0
2001.....	502.5	6.6	10.2	64.2	421.6
2000.....	497.1	6.2	10.3	65.3	415.2
1999.....	522.4	6.9	11.2	72.9	431.4
1998.....	564.1	8.4	12.0	85.1	458.5
1997.....	595.0	8.6	12.1	92.5	481.9
Percent change in rate					
2005 to 2006.....	-0.9	-1.5	0.0	10.3	-2.9
2004 to 2005.....	-2.6	-2.9	-7.6	0.3	-3.0
2003 to 2004.....	-5.1	6.1	-10.2	0.2	-6.0
2002 to 2003.....	-2.4	-2.9	-5.4	1.3	-2.9
2001 to 2002.....	-5.0	3.0	-8.8	-3.3	-5.4
2000 to 2001.....	1.1	6.5	-1.0	-1.7	1.5
1999 to 2000.....	-4.8	-10.1	-8.0	-10.4	-3.8
1998 to 1999.....	-7.4	-17.9	-6.7	-14.3	-5.9
1997 to 1998.....	-5.2	-2.3	-0.8	-8.0	-4.9
1997 to 2006.....	-28.4	-22.1	-39.7	-24.6	-28.9

Notes: Rates may not add to total because of rounding.
 Rates are based on annual population estimates provided by the Demographic Research Unit, California Department of Finance.

¹ Rates are based on the total population at risk (10-69 years of age).

Table 30
HOMICIDE ARRESTS, 1997-2006
 By Gender of Arrestee

Year(s)	Total		Male		Female	
	Number	Percent	Number	Percent	Number	Percent
2006.....	1,967	100.0	1,732	88.1	235	11.9
2005.....	1,956	100.0	1,737	88.8	219	11.2
2004.....	1,978	100.0	1,745	88.2	233	11.8
2003.....	1,839	100.0	1,627	88.5	212	11.5
2002.....	1,864	100.0	1,655	88.8	209	11.2
2001.....	1,754	100.0	1,537	87.6	217	12.4
2000.....	1,627	100.0	1,426	87.6	201	12.4
1999.....	1,770	100.0	1,579	89.2	191	10.8
1998.....	2,117	100.0	1,870	88.3	247	11.7
1997.....	2,212	100.0	1,990	90.0	222	10.0

Table 31
HOMICIDE ARRESTS, 1997-2006
 By Race/Ethnic Group of Arrestee

Year(s)	Total		White		Hispanic		Black		Other	
	Number	Percent	Number	Percent	Number	Percent	Number	Percent	Number	Percent
2006.....	1,967	100.0	351	17.8	910	46.3	539	27.4	167	8.5
2005.....	1,956	100.0	386	19.7	946	48.4	487	24.9	137	7.0
2004.....	1,978	100.0	409	20.7	932	47.1	476	24.1	161	8.1
2003.....	1,839	100.0	424	23.1	812	44.2	456	24.8	147	8.0
2002.....	1,864	100.0	349	18.7	897	48.1	455	24.4	163	8.7
2001.....	1,754	100.0	400	22.8	832	47.4	406	23.1	116	6.6
2000.....	1,627	100.0	374	23.0	698	42.9	397	24.4	158	9.7
1999.....	1,770	100.0	382	21.6	845	47.7	417	23.6	126	7.1
1998.....	2,117	100.0	484	22.9	987	46.6	470	22.2	176	8.3
1997.....	2,212	100.0	447	20.2	1,017	46.0	586	26.5	162	7.3

Note: Percentages may not add to 100.0 because of rounding.

Table 32
HOMICIDE ARRESTS, 1997-2006
 By Age of Arrestee

Year(s)	Total		Under 18		18-29		30-39		40 and over	
	Number	Percent	Number	Percent	Number	Percent	Number	Percent	Number	Percent
2006.....	1,967	100.0	241	12.3	1,154	58.7	267	13.6	305	15.5
2005.....	1,956	100.0	185	9.5	1,207	61.7	281	14.4	283	14.5
2004.....	1,978	100.0	185	9.4	1,143	57.8	313	15.8	337	17.0
2003.....	1,839	100.0	167	9.1	1,077	58.6	326	17.7	269	14.6
2002.....	1,864	100.0	215	11.5	1,097	58.9	293	15.7	259	13.9
2001.....	1,754	100.0	194	11.1	1,011	57.6	291	16.6	258	14.7
2000.....	1,627	100.0	160	9.8	913	56.1	299	18.4	255	15.7
1999.....	1,770	100.0	182	10.3	1,037	58.6	317	17.9	234	13.2
1998.....	2,117	100.0	308	14.5	1,244	58.8	302	14.3	263	12.4
1997.....	2,212	100.0	353	16.0	1,267	57.3	326	14.7	266	12.0

Note: Percentages may not add to 100.0 because of rounding.

Table 33
HOMICIDE ARRESTS, 2006
 Race/Ethnic Group of Arrestee by Gender and Age of Arrestee

Gender and age of arrestee	Total		White		Hispanic		Black		Other	
	Number	Percent	Number	Percent	Number	Percent	Number	Percent	Number	Percent
Total										
Total.....	1,967	100.0	351	100.0	910	100.0	539	100.0	167	100.0
Gender										
Male.....	1,732	88.1	282	80.3	820	90.1	485	90.0	145	86.8
Female.....	235	11.9	69	19.7	90	9.9	54	10.0	22	13.2
Age										
Under 18.....	241	12.3	15	4.3	121	13.3	80	14.8	25	15.0
18-29.....	1,154	58.7	153	43.6	596	65.5	308	57.1	97	58.1
30-39.....	267	13.6	57	16.2	115	12.6	70	13.0	25	15.0
40 and over.....	305	15.5	126	35.9	78	8.6	81	15.0	20	12.0

Note: Percentages may not add to 100.0 because of rounding.

Table 34
HOMICIDE ARRESTS, 2006
Race/Ethnic Group of Arrestee by Gender and Age of Arrestee

Gender and age of arrestee	Total		White		Hispanic		Black		Other	
	Number	Percent	Number	Percent	Number	Percent	Number	Percent	Number	Percent
Total.....	1,967	100.0	351	100.0	910	100.0	539	100.0	167	100.0
Under 18.....	241	12.3	15	4.3	121	13.3	80	14.8	25	15.0
18-19.....	304	15.5	35	10.0	160	17.6	83	15.4	26	15.6
20-24.....	524	26.6	66	18.8	280	30.8	133	24.7	45	26.9
25-29.....	326	16.6	52	14.8	156	17.1	92	17.1	26	15.6
30-34.....	152	7.7	30	8.5	65	7.1	41	7.6	16	9.6
35-39.....	115	5.8	27	7.7	50	5.5	29	5.4	9	5.4
40-44.....	102	5.2	37	10.5	30	3.3	30	5.6	5	3.0
45-49.....	88	4.5	36	10.3	22	2.4	27	5.0	3	1.8
50-54.....	49	2.5	20	5.7	9	1.0	12	2.2	8	4.8
55 and over....	66	3.4	33	9.4	17	1.9	12	2.2	4	2.4
Male.....	1,732	100.0	282	100.0	820	100.0	485	100.0	145	100.0
Under 18.....	231	13.3	14	5.0	117	14.3	75	15.5	25	17.2
18-19.....	279	16.1	29	10.3	152	18.5	78	16.1	20	13.8
20-24.....	452	26.1	46	16.3	249	30.4	118	24.3	39	26.9
25-29.....	287	16.6	45	16.0	135	16.5	85	17.5	22	15.2
30-34.....	136	7.9	23	8.2	62	7.6	37	7.6	14	9.7
35-39.....	96	5.5	23	8.2	41	5.0	26	5.4	6	4.1
40-44.....	77	4.4	25	8.9	26	3.2	21	4.3	5	3.4
45-49.....	72	4.2	30	10.6	16	2.0	23	4.7	3	2.1
50-54.....	45	2.6	17	6.0	9	1.1	11	2.3	8	5.5
55 and over...	57	3.3	30	10.6	13	1.6	11	2.3	3	2.1
Female.....	235	100.0	69	100.0	90	100.0	54	100.0	22	100.0
Under 18.....	10	4.3	1	1.4	4	4.4	5	9.3	0	-
18-19.....	25	10.6	6	8.7	8	8.9	5	9.3	6	-
20-24.....	72	30.6	20	29.0	31	34.4	15	27.8	6	-
25-29.....	39	16.6	7	10.1	21	23.3	7	13.0	4	-
30-34.....	16	6.8	7	10.1	3	3.3	4	7.4	2	-
35-39.....	19	8.1	4	5.8	9	10.0	3	5.6	3	-
40-44.....	25	10.6	12	17.4	4	4.4	9	16.7	0	-
45-49.....	16	6.8	6	8.7	6	6.7	4	7.4	0	-
50-54.....	4	1.7	3	4.3	0	0.0	1	1.9	0	-
55 and over...	9	3.8	3	4.3	4	4.4	1	1.9	1	-

Notes: Percentages may not add to 100.0 because of rounding.
Dash indicates that percent distributions are not calculated when the base number is less than 50.

Table 35
**PERSONS UNDER CALIFORNIA
 SENTENCE OF DEATH, 1978-2006**

Year(s)	Initial sentences	Total persons under sentence of death ^{1,2}
2006.....	17	665
2005.....	22	654
2004.....	12	642
2003.....	22	639
2002.....	17	618
2001.....	25	610
2000.....	33	589
1999.....	42	558
1998.....	32	518
1997.....	40	493
1996.....	40	461
1995.....	38	426
1994.....	21	391
1993.....	34	374
1992.....	40	345
1991.....	26	305
1990.....	33	279
1989.....	33	247
1988.....	34	223
1987.....	25	203
1986.....	21	179
1985.....	16	159
1984.....	27	161
1983.....	35	143
1982.....	39	113
1981.....	39	80
1980.....	23	42
1979.....	20	25
1978.....	7	7

Source: California Appellate Project.

¹ Total persons under sentence of death on December 31 of each year. Persons with multiple California death sentences are counted once.

² The increase in the total number of persons under sentence of death from year-to-year will *not* equal the number of initial sentences reported each year. This is because, in addition to initial sentences, persons may be resentenced to death, no longer under sentence of death because of execution or death by other causes, removed pending retrial, resentenced to a penalty less than death, or freed.

Table 36
PERSONS SENTENCED TO DEATH, 2006
 Sentencing County by Gender, Race/Ethnic Group, and Age

Sentencing county	Total	Gender		Race/ethnic group				Age at arrest					
		Male	Female	White	Hispanic	Black	Other	Under 20	20-24	25-29	30-34	35-39	40 and over
Total.....	17	16	1	7	5	4	1	1	3	4	3	3	3
Contra Costa.....	1	1	0	1	0	0	0	0	0	0	0	1	0
Los Angeles.....	1	1	0	0	1	0	0	0	1	0	0	0	0
Riverside.....	3	2	1	2	1	0	0	0	2	0	0	0	1
Sacramento.....	1	1	0	0	1	0	0	0	0	0	0	0	1
San Bernardino....	4	4	0	1	1	2	0	0	0	1	1	1	1
San Diego.....	2	2	0	1	1	0	0	0	0	1	1	0	0
San Joaquin.....	1	1	0	0	0	0	1	1	0	0	0	0	0
Santa Barbara.....	1	1	0	1	0	0	0	0	0	1	0	0	0
Stanislaus.....	1	1	0	1	0	0	0	0	0	0	0	1	0
Tulare.....	2	2	0	0	0	2	0	0	0	1	1	0	0

Note: This table does not include persons resentenced to death after their death sentence was reversed on appeal.

Table 37
HOMICIDE CRIMES AND PEACE OFFICERS KILLED IN THE LINE OF DUTY, 1997-2006
 Number and Rate per 100,000 Respective Population

Year(s)	California population	Homicides		Sworn law enforcement personnel ²	Peace officers killed in the line of duty	
		Number ¹	Rate		Number	Rate
2006.....	37,444,385	2,483	6.6	75,625	5	6.6
2005.....	37,004,661	2,503	6.8	74,445	5	6.7
2004.....	36,590,814	2,394	6.5	73,951	4	5.4
2003.....	35,934,000	2,402	6.7	75,336	6	8.0
2002.....	35,301,000	2,392	6.8	75,612	4	5.3
2001.....	34,758,000	2,201	6.3	72,119	6	8.3
2000.....	34,480,000	2,074	6.0	69,029	2	2.9
1999.....	34,036,000	2,006	5.9	69,363	4	5.8
1998.....	33,494,000	2,170	6.5	67,035	7	10.4
1997.....	32,957,000	2,579	7.8	65,416	7	10.7

Note: Homicide rates are based on annual population estimates provided by the Demographic Research Unit, California Department of Finance.

¹ Includes peace officers feloniously killed in the line of duty.

² Personnel in the Department of Justice and other state regulatory agencies are not included.

Table 38
PEACE OFFICERS KILLED IN THE LINE OF DUTY, 2006
 By Contributing Circumstance

Contributing circumstance	Number	Percent
Total.....	5	100.0
Responding to disturbance call.....	1	-
Pursuing robbery suspect.....	1	-
Routine traffic stop.....	3	-

Note: Dash indicates that percent distributions are not calculated when the base number is less than 50.

Table 39
**JUSTIFIABLE HOMICIDES BY PEACE OFFICERS
OR PRIVATE CITIZENS, 2006**
By Gender, Race/Ethnic Group, and Age of Deceased

Gender, race/ethnic group, and age of deceased	Total		Peace officer justifiable		Private citizen justifiable	
	Number	Percent	Number	Percent	Number	Percent
Total						
Total.....	157	100.0	124	100.0	33	100.0
Gender						
Male.....	152	96.8	119	96.0	33	100.0
Female.....	5	3.2	5	4.0	0	0.0
Race/ethnic group						
White.....	43	27.4	38	30.6	5	15.2
Hispanic.....	65	41.4	52	41.9	13	39.4
Black.....	38	24.2	26	21.0	12	36.4
Other.....	11	7.0	8	6.5	3	9.1
Unknown.....	0	0.0	0	0.0	0	0.0
Age						
Under 18.....	6	3.8	5	4.0	1	3.0
18-19.....	9	5.7	7	5.6	2	6.1
20-24.....	40	25.5	23	18.5	17	51.5
25-29.....	25	15.9	21	16.9	4	12.1
30-34.....	22	14.0	19	15.3	3	9.1
35-39.....	13	8.3	11	8.9	2	6.1
40-44.....	21	13.4	19	15.3	2	6.1
45-49.....	9	5.7	7	5.6	2	6.1
50-54.....	4	2.5	4	3.2	0	0.0
55 and over.....	8	5.1	8	6.5	0	0.0
Unknown.....	0	0.0	0	0.0	0	0.0

Note: Percentages may not add to 100.0 because of rounding.

Table 40
**JUSTIFIABLE HOMICIDES BY PEACE OFFICERS
OR PRIVATE CITIZENS, 2006**
By Location of Justifiable Homicide

Location of justifiable homicide	Number	Percent
Total		
Total.....	157	
Peace officer justifiable		
Total.....	124	100.0
Felon's residence.....	0	0.0
Other residence.....	33	26.6
Street, sidewalk.....	71	57.3
Commercial establishment..	2	1.6
Hotel, motel.....	1	0.8
Liquor store.....	0	0.0
Bar.....	0	0.0
Other business.....	1	0.8
All other.....	18	14.5
Parking lot.....	6	4.8
Vehicle.....	4	3.2
Field, park.....	2	1.6
Other.....	6	4.8
Citizen justifiable		
Total.....	33	100.0
Citizen's, shared residence..	1	3.0
Citizen's residence.....	1	3.0
Shared residence.....	0	0.0
Other residence.....	16	48.5
Felon's residence.....	13	39.4
Other residence.....	3	9.1
Street, sidewalk.....	7	21.2
Commercial establishment..	6	18.2
Hotel, motel.....	0	0.0
Liquor store.....	0	0.0
Bar.....	1	3.0
Other business.....	5	15.2
All other.....	3	9.1
Parking lot.....	3	9.1
Vehicle.....	0	0.0
Field, park.....	0	0.0
Other.....	0	0.0

Note: Percentages may not add to subtotals or 100.0 because of rounding.

Table 41
**JUSTIFIABLE HOMICIDES BY PEACE OFFICERS
OR PRIVATE CITIZENS, 2006**
By Contributing Circumstance

Contributing circumstance	Number	Percent
Total		
Total.....	157	
Peace officer justifiable		
Total.....	124	100.0
Felon attacked peace officer.....	113	91.1
Felon killed during commission of crime..	6	4.8
Felon resisted arrest.....	4	3.2
All other.....	1	0.8
Felon attacked another peace officer...	0	0.0
Felon attacked citizen.....	1	0.8
Felon attempted flight.....	0	0.0
Citizen justifiable		
Total.....	33	100.0
Felon attacked citizen.....	11	33.3
Felon killed during commission of crime..	21	63.6
Felon attempted flight.....	1	3.0

Note: Percentages may not add to 100.0 because of rounding.

Table 42
**JUSTIFIABLE HOMICIDES BY PEACE OFFICERS
OR PRIVATE CITIZENS, 2006**
By Type of Weapon Used

Type of weapon used	Total		Peace officer justifiable		Citizen justifiable	
	Number	Percent	Number	Percent	Number	Percent
Total.....	157	100.0	124	100.0	33	100.0
Firearm.....	148	94.3	124	100.0	24	72.7
Handgun.....	137	87.3	114	91.9	23	69.7
Rifle.....	7	4.5	6	4.8	1	3.0
Shotgun.....	4	2.5	4	3.2	0	0.0
Other firearm.....	0	0.0	0	0.0	0	0.0
Firearm - unknown type..	0	0.0	0	0.0	0	0.0
Nonfirearm.....	9	5.7	0	0.0	9	27.3
Knife ¹	8	5.1	0	0.0	8	24.2
Blunt object ²	0	0.0	0	0.0	0	0.0
Other.....	1	0.6	0	0.0	1	3.0

Note: Percentages may not add to subtotals or to 100.0 because of rounding.

¹ Any instrument used to cut or stab.

² Club, etc.

Table 43
POPULATION ESTIMATES, 1952-2006

Year(s)	Total population	Population at risk		
		Total ¹	Adult ²	Juvenile ³
2006.....	37,444,385	29,236,911	24,731,088	4,505,823
2005.....	37,004,661	28,809,579	24,316,140	4,493,439
2004.....	36,590,814	28,357,204	23,906,564	4,450,640
2003.....	35,934,000	27,815,344	23,295,523	4,519,821
2002.....	35,301,000	27,302,433	22,927,383	4,375,050
2001.....	34,758,000	26,745,137	22,555,739	4,189,398
2000.....	34,480,000	26,203,950	22,198,297	4,005,653
1999.....	34,036,000	25,711,892	21,855,190	3,856,702
1998.....	33,494,000	25,263,064	21,498,170	3,764,894
1997.....	32,957,000	25,760,375	21,934,916	3,825,459
1996.....	32,383,000	25,554,242	21,825,735	3,728,507
1995.....	32,063,000	25,122,782	21,505,839	3,616,943
1994.....	32,140,000	24,703,379	21,193,571	3,509,808
1993.....	31,742,000	24,334,534	20,923,632	3,410,902
1992.....	31,300,000	23,975,578	20,661,120	3,314,458
1991.....	30,646,000	23,585,168	20,356,984	3,228,184
1990.....	29,557,836	23,178,961	20,027,633	3,151,328
1989.....	28,771,207	22,524,392	19,451,763	3,072,629
1988.....	28,060,746	21,969,953	18,885,349	3,084,604
1987.....	27,388,477	21,483,563	18,378,758	3,104,805
1986.....	26,741,621	21,009,362	17,903,122	3,106,240
1985.....	26,112,632	20,563,314	17,468,941	3,094,373
1984.....	25,587,254	20,167,923	17,083,479	3,084,444
1983.....	25,075,581	19,860,746	16,763,095	3,097,651
1982.....	24,546,566	19,510,945	16,415,571	3,095,374
1981.....	24,038,711	19,172,812	16,082,355	3,090,457
1980.....	23,668,145	18,824,197	15,778,999	3,045,198
1979.....	23,255,000	18,371,691	15,323,376	3,048,315
1978.....	22,839,000	18,012,901	14,916,032	3,096,869
1977.....	22,350,000	17,619,453	14,470,680	3,148,773
1976.....	21,935,000	17,269,884	14,080,872	3,189,012
1975.....	21,537,000	16,914,556	13,694,793	3,219,763
1974.....	21,173,000	16,563,671	13,339,906	3,223,765
1973.....	20,868,000	16,237,031	13,031,007	3,206,024
1972.....	20,585,000	15,926,249	12,758,809	3,167,440
1971.....	20,346,000	15,657,238	12,542,795	3,114,443
1970.....	20,039,000	15,378,312	12,339,580	3,038,732
1969.....	19,856,000	14,697,200	11,657,600	3,039,600
1968.....	19,554,000	14,379,400	11,403,700	2,975,700
1967.....	19,478,000	14,065,700	11,159,800	2,905,900
1966.....	19,132,000	13,696,700	10,872,500	2,824,200
1965.....	18,756,000	13,377,400	10,620,600	2,756,800
1964.....	18,234,000	12,981,700	10,311,100	2,670,600
1963.....	17,675,000	12,564,600	10,047,700	2,516,900
1962.....	17,044,000	12,099,200	9,740,000	2,359,200
1961.....	16,445,000	11,697,900	9,469,100	2,228,800
1960.....	15,860,000	11,314,900	9,203,300	2,111,600
1959.....	15,280,000	-	-	-
1958.....	14,752,000	-	-	-
1957.....	14,190,000	-	-	-
1956.....	13,600,000	-	-	-
1955.....	13,035,000	-	-	-
1954.....	12,595,000	-	-	-
1953.....	12,101,000	-	-	-
1952.....	11,638,000	-	-	-

Source: Population estimates were provided by the Demographic Research Unit, California Department of Finance.

Note: Population data by age are not available prior to 1960.

¹ Total population at risk, 10-69 years of age.

APPENDICES



COMPUTATIONAL FORMULAS

ARREST RATE – An arrest rate describes the number of arrests made by law enforcement agencies per 100,000 total population or per 100,000 population considered to be at risk for arrest. Regardless of the population used, both rates are calculated in the same manner. An arrest rate is calculated by dividing the number of reported arrests by the respective population; the result is multiplied by 100,000. For example, in 2006 there were 1,967 homicide arrests. The total population was 37,444,385 and the total population at risk (10–69 years of age) was 29,236,911.

$$\frac{1,967}{37,444,385} = 0.000052531 \times 100,000 = 5.3 \text{ per } 100,000 \text{ population}$$

$$\frac{1,967}{29,236,911} = 0.000067277 \times 100,000 = 6.7 \text{ per } 100,000 \text{ population at risk}$$

CLEARANCE RATE – A clearance rate is the percentage of crimes reported that have been cleared. A clearance rate is calculated by dividing the number of crimes cleared by the number of crimes reported; the result is multiplied by 100. For example, in 2006 there were 1,292 homicides cleared and 2,483 homicides reported. This equals a homicide clearance rate of 52.0 percent.

$$\frac{1,292}{2,483} = 0.520338300 \times 100 = 52.0 \text{ percent}$$

CRIME RATE – A crime rate describes the number of crimes reported to law enforcement agencies per 100,000 total population. A crime rate is calculated by dividing the number of reported crimes by the total population; the result is multiplied by 100,000. For example, in 2006 there were 2,483 homicides in California and the population was 37,444,385. This equals a homicide crime rate of 6.6 per 100,000 general population.

$$\frac{2,483}{37,444,385} = 0.000066311 \times 100,000 = 6.6 \text{ per } 100,000 \text{ population}$$

PERCENT CHANGE – A percent change describes a change in number or rate from one year to another. A percent change is calculated by subtracting base-year data from current-year data; the result is divided by base-year data and multiplied by 100. For example, in 2006 the homicide crime rate was 6.6. In 1997 the homicide crime rate was 7.8. The percent change in rate from 1997 to 2006 is a 15.4 percent decrease.

$$\frac{6.6 - 7.8}{7.8} = -0.153846153 \times 100 = -15.4 \text{ percent}$$

POPULATION AT RISK – Arrest section data tables include three comparison populations: total (10–69 years of age), adult (18–69 years of age), and juvenile (10–17 years of age).

Notes: When a series of rates are calculated using different populations, the rate calculated for the total will not be equal to the sum of the rates calculated for each subtotal. For example, the total arrest rate (calculated using the *total* at-risk population) will not equal the sum of the adult arrest rate (calculated using the *adult* at-risk population) and the juvenile arrest rate (calculated using the *juvenile* at-risk population).

Calculating rates for counties of less than 100,000 will generate an inflated rate when compared to counties with populations of 100,000 or more; therefore, rates are not calculated for counties with populations of less than 100,000.

CRIMINAL JUSTICE GLOSSARY

ACQUITTAL: a judgment of a court, based either on the verdict of a jury or a judicial officer, that the defendant is not guilty of the offense(s) for which he/she was tried.

ADULT: a person 18 years of age or older.

AGGRAVATED ASSAULT: an unlawful attack or attempted attack by one person upon another for the purpose of inflicting severe or aggravated bodily injury. This type of assault usually is accompanied by the use of a weapon or by means likely to produce death or great bodily harm (UCR definition).

APPEAL: a petition initiated by a defendant for a rehearing in an appellate court regarding a previous sentence or motion.

ARREST: ". . . taking a person into custody, in a case and in the manner authorized by law. An arrest may be made by a peace officer or by a private person" (834 PC).

ARREST RATE: the number of arrests per 100,000 population. See "Computational Formulas" (preceding page) for further explanation.

CALIFORNIA DEPARTMENT OF THE YOUTH AUTHORITY (CYA): the state agency which has jurisdiction over and maintains institutions as correctional schools for the reception of wards of the juvenile court and other persons committed from trial courts.

CLEARANCE: an offense is "cleared by arrest" or solved, for crime reporting purposes, when at least one person is arrested, charged with the commission of an offense, and turned over to a court for prosecution. Although no physical arrest is made, a clearance by arrest can be claimed when an offender is a person under 18 years of age and is cited to appear in juvenile court or before other juvenile authorities. An offense can also be "cleared exceptionally" for crime reporting purposes when an investigation has definitely established the identity of an offender; there is enough information to support an arrest; and the exact location of an offender is known but, for some reason, law enforcement cannot take the offender into custody.

CLEARANCE RATE: the percentage of crimes reported that have been cleared.

COMBINED CASES: cases rejected by the prosecutor in favor of other counts/cases.

COMPLAINT: a verified written accusation, filed by a prosecuting attorney with a local criminal court, which charges one or more persons with the commission of one or more offenses.

CONVICTION: a judgment, based either on the verdict of a jury or a judicial officer or on the guilty plea of the defendant, that the defendant is guilty.

COURT: an agency of the judicial branch of government, authorized or established by statute or constitution, having one or more judicial officers on its staff. A court has the authority to decide upon controversies in law and disputed matters of fact brought before it. Because of court consolidation we no longer distinguish between lower court and superior court.

CRIME: ". . . an act committed or omitted in violation of a law forbidding or commanding it. . ." (15 PC).

CRIME RATE: the number of reported crimes per 100,000 general population. See "Computational Formulas" (preceding page) for further explanation.

CYA: see "California Department of the Youth Authority."

DISMISSAL: a decision by a judicial officer to terminate a case without a determination of guilt or innocence.

DISPOSITION – COURT: an action taken as the result of an appearance in court by a defendant. Examples are: adults - dismissed, acquitted, or convicted; juveniles - dismissed, transferred, or remanded to adult court.

DISPOSITION – LAW ENFORCEMENT: an action taken as the result of an arrest. Examples of police dispositions are: adults – released by law enforcement, referred to another jurisdiction, or a misdemeanor or felony complaint sought; juveniles – handled within the department, referred to another agency, or referred to the probation department or juvenile court.

DISPOSITION – PROSECUTOR: an action taken as the result of a complaint requested by an arresting agency. Dispositions include granting a misdemeanor or a felony complaint or denying a complaint for reasons such as lack of sufficient evidence or complainant refuses to testify.

DIVERSION: a disposition of a criminal defendant either before adjudication or following adjudication, but prior to sentencing, in which the court directs the defendant to participate in a work, educational, or rehabilitative program.

CRIMINAL JUSTICE GLOSSARY

DIVERSION DISMISSED: the successful completion of a diversion program.

EXCEPTIONAL MEANS: an offense can also be "cleared exceptionally" for crime reporting purposes when an investigation has definitely established the identity of an offender; there is enough information to support an arrest; and the exact location of an offender is known but, for some reason, law enforcement cannot take the offender into custody.

FELON: one who has committed a felony.

FELONY: a crime which is punishable by death or by imprisonment in a state prison (17 & 18 PC).

FILING: a document filed with the court clerk or county clerk by a prosecuting attorney alleging that a person committed or attempted to commit a crime.

FORCIBLE RAPE: the carnal knowledge of a female forcibly and against her will. Assaults or attempts to commit rape by force or threat of force are included (UCR definition).

HOMICIDE: the willful (nonnegligent) killing of one human being by another. Murder and nonnegligent manslaughter are included (UCR definition).

JAIL: a county or city facility for incarceration of sentenced and unsentenced persons.

JUVENILE: a person under the age of 18.

MISDEMEANOR: a crime punishable by imprisonment in a county jail for up to one year.

MONTHLY ARREST AND CITATION REGISTER (MACR): a reporting system used to collect information on adult and juvenile arrests and citations by police and sheriffs' departments. This register contains data on arrest offenses, arrestee characteristics (age, gender, and race/ethnic group), and law enforcement dispositions.

OFFENDER-BASED TRANSACTION STATISTICS (OBTS): a system designed to collect statistical information on the various processes within the criminal justice system that occur between the point of the felony arrest of an adult and the point of final disposition.

OFFENSE: the charged offense is the crime for which the defendant was arrested or filed on by the district attorney. The convicted offense is the offense the defendant was convicted of or pled guilty to in court.

PC (PENAL CODE): the California Penal Code contains statutes that define criminal offenses and specify corresponding punishments. Criminal justice system mandates and procedures are also included.

POPULATION AT RISK: that portion of the total population who, because of like characteristics to the specific study group, are considered "at risk." For example, if one were studying juvenile arrestees, all persons between 10 and 17 years of age would constitute the at-risk population.

PRISON: a state correctional facility where persons are confined following conviction for a felony offense.

PROBATION: a judicial requirement that a person fulfill certain conditions of behavior in lieu of a sentence to confinement. See "Straight Probation."

PROBATION WITH JAIL: a type of disposition given upon conviction which imposes a jail term as a condition of probation.

RATE: a comparison of a number of events to a population.

REMAND: to send back (a case) to another court for further action.

ROBBERY: the taking or attempting to take anything of value from the care, custody, or control of a person or persons by force or threat of force or violence and/or by creating fear in the victim (UCR definition).

SENTENCE: the penalty imposed by a court upon a convicted person.

STRAIGHT PROBATION: probation granted to adults without condition or stipulation that the defendant serve time in jail as a condition of probation.

UNIFORM CRIME REPORTING (UCR): a federal reporting system which compiles crime data based on information submitted by law enforcement agencies throughout the nation. In California, the Department of Justice administers and forwards these law enforcement data to the federal program.

VIOLENT CRIMES: crimes committed against people. This category includes homicide, forcible rape, robbery, and aggravated assault.

YOUTH AUTHORITY: see "California Department of the Youth Authority."

CJSC PUBLICATIONS

Annual Publications

Anti-Reproductive-Rights Crimes in California**
Crime in California**
Crime in California, Advance Release**
Criminal Justice Profile - A Supplement to
Crime in California (statewide and individual
counties)**
Hate Crime in California**
Homicide in California**
Juvenile Justice in California**
Preliminary Report, Crime (January
through June, January through September,
and January through December)**

Foci and Forums

The California Experience in American
Juvenile Justice: Some Historical
Perspectives (December 1988)
Controlling Plea Bargaining in California
(September 1985)
Coordinating Justice in California: "There
ought to be a law about it" (December
1988)
Crime Control and the Criminal Career
(December 1992)
The Development of California Drunk
Driving Legislation (December 1988)
Employment and Crime (February 1989)
The Impact of California's "Prior Felony
Conviction" Law (September 1987)
The Origins and Development of Penalties
for Drunk Drivers in California (August
1988)
A Policy Role for Focus Groups:
Community Corrections (September
1991)
The Prevalence and Incidence of Arrests
Among Adult Males in California (August
1988)
The Social Structure of Street Drug
Dealing (December 1988)

Outlooks

Adult Felony Arrest Dispositions in
California (1982-1984, 1986-1989)
Crime in Urban and Rural California
(November 1984 and December 1997)**
Death in Custody, California (May 2005)**
Felony Drug Arrests in California, 1985
(December 1986)

Juvenile Justice in California, 1983 (June
1984)
Motor Vehicle Theft in California
(December 1987)
Motor Vehicle Theft Recovery Data,
1983-1989 (October 1990)
Women in Crime: The Sentencing of
Female Defendants (April 1988)

Reports

Adult Felony Arrest Dispositions in
California (April 1992)
Concealable Firearms Charges in California**
(2000-2003)
Crime in California and the United States,
(1983, 1990, 2000)**
Effectiveness of Statutory Requirements
for the Registration of Sex Offenders - A
Report to the California State Legislature
Executive Summary of the Final Report -
Blue Ribbon Commission on Inmate
Population Management (January 1990)
The Juvenile Justice System in California:
An Overview (April 1989)
Parolees Returned to Prison and the
California Prison Population (January
1988)
Target Hardening: A Literature Review
(October 1989)

Report Series

Report on Arrests for Burglary in California,
1998**
Report on Arrests for Domestic Violence in
California, 1998**
Report on Arrests for Driving Under the
Influence in California, 1997**
Report on Drug Arrests in California, From
1990 to 1999 (December 2000)**
Report on Juvenile Felony Arrests in
California, 1998 (March 2000)**
Report on Violent Crimes Committed
Against Senior Citizens in California,
1998**

Research Series

Why Did the Crime Rate Decrease Through
1999? (And Why Might it Decrease or
Increase in 2000 and Beyond?)
(December 2000)**

Special Report to the Legislature on
Senate Bill 780 (California Freedom of
Access to Clinic and Church Entrances
Act and Reproductive Rights Law
Enforcement Act) (August 2003)
Special Report to the Legislature on
Senate Bill 1608 (Felons and others
with firearms) (July 2002)
Special Report to the Legislature on
Senate Resolution 18 (Crimes Committed
Against Homeless Persons) (October
2002)**

Monograph Series

Conspicuous Depredation: Automobile
Theft in Los Angeles, 1904 to 1987
(March 1990)
Controlling Felony Plea Bargaining in
California: The Impact of the Victim's
Bill of Rights (1986)
Development of a White Collar Crime
Index (December 1992)
Incapacitation Strategies and the Career
Criminal (December 1992)
Measuring White Collar Crime in
Depository Institutions (December 1993)
Prosecutors' Response to Parental Child
Stealing: A Statewide Study (April 1995)
Race & Delinquency in Los Angeles
Juvenile Court, 1950 (December 1990)
Survey Report: "The Expansion of the
Criminal Justice and Penal System in
California - Is greater coordination
required?" (December 1988)

Miscellaneous

California Criminal Justice Time Line,
1822-2000 (June 2001)**
Crime in California (April 2001)**
Gang Organization and Migration/Drugs,
Gangs & Law Enforcement
Proceedings of the Attorney General's
Crime Conference 85 (September 1985)
Proceedings of Symposium 87: White
Collar/Institutional Crime - Its Measure-
ment and Analysis

**Available on the Internet.

For publications or assistance in obtaining statistical information or a customized statistical report, please contact:

California Department of Justice
Bureau of Criminal Information and Analysis
Criminal Justice Statistics Center
Special Requests Unit
P.O. Box 903427
Sacramento, CA 94203-4270

Phone: (916) 227-3509 **Fax:** (916) 227-0427 **E-mail:** cjsc@doj.ca.gov **Internet:** <http://ag.ca.gov/cjsc>

Annual publications from 1999-2005 are also available on CD-ROM, including data tables in the Excel spreadsheet format.

California Department of Justice
Division of California Justice Information Services
Bureau of Criminal Information and Analysis
CRIMINAL JUSTICE STATISTICS CENTER
P. O. Box 903427
Sacramento, CA 94203-4270

*Forwarding and Address
Correction Requested*