

# prosense® Vibration Monitoring

## Vibration Monitoring (Machine Condition Monitoring)

Vibration Monitoring, also referred to as Machine Condition Monitoring, is used to monitor, analyze, and identify vibrations of industrial equipment, which may indicate a malfunction, pending failure, or process restriction. Vibration analysis can identify developing problems allowing for timely and predictable maintenance scheduling before major damage or failure, and production downtime. Primarily, it is used to determine the operating and mechanical condition/health of rotating equipment such as pumps, motors, compressors, paper machines, rolling mills, machine tools, and gearboxes. Vibration sensors can also be used to measure vibration as a process variable, for example, material handling/positioning systems looking for an impact/vibration when something is moved or placed.

## Common Industrial Maintenance Strategies

There are 3 basic types of industrial maintenance processes and each have costs associated with them.

**Reactive maintenance** - highest total cost of ownership. Run-to-failure strategy and unplanned downtime is usually more expensive than planned downtime and typically there is secondary damage to other components.

**Preventative maintenance** - downtime is scheduled prior to failure, but it carries a high cost because parts and labor are consumed prematurely.

**Predictive or Condition-based maintenance** - uses real-time (continuous) monitoring technology to optimize equipment use. Maintenance is performed only when necessary, based on the actual condition and health of the machine, and without production loss.

Total cost of ownership by maintenance strategy

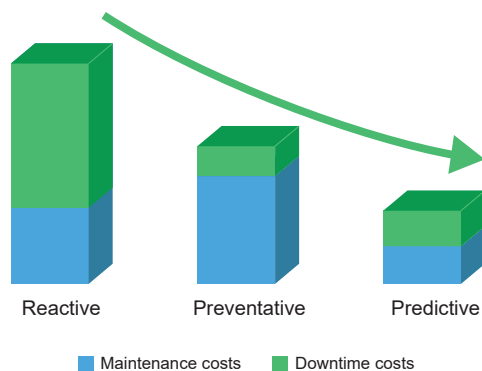

## Real-time Maintenance (RtM) Technologies for Predictive Maintenance

For industrial companies, operational worthiness in real-time is key to improving OEE (Overall Equipment Effectiveness) and increasing profits. Applying Real-time Maintenance technologies such as continuous vibration monitoring to production equipment increases equipment availability, maintains machine throughput, and minimizes material losses. With RtM vibration monitoring products, machines are continuously monitored and have their operational status communicated in real-time, allowing for automatically planned maintenance, reduced downtime, and improved quality.....all improving the bottom line.

## Standard DIN ISO 10816: Mechanical Vibration - Evaluation of Machine Vibration by Measurements on Non-Rotating Parts

According to DIN ISO 10816, the vibration of a machine depends on its size, vibrating body characteristics, mounting system, and purpose. For most machines, regardless of the type of bearings used, measurements of the broad-band RMS vibration velocity on structural parts, such as bearing housings, adequately characterize the running conditions of the rotating shaft elements with respect to their trouble-free operation.

# prosense® Vibration Monitoring

## Standard DIN ISO 10816: Mechanical Vibration - Continued

Measurements should be taken on the bearings, bearing support housing or other structural parts which significantly respond to the dynamic forces transmitted from the rotating elements at the bearing locations and characterize the overall vibration of the machine. For most machine types, measuring vibration at a single location will characterize the vibratory state of that machine. However, for some machines it may be necessary to measure vibration at various positions, possibly in two or three directions. The forces on a rotating device, such as a motor armature or a bearing, are predominately found radially to the direction of rotation. Failure modes like unbalance, misalignment and bearing damage are first detected in the radial direction. Therefore, measuring a single axis in the radial direction is the most common and effective method of vibration measurement.

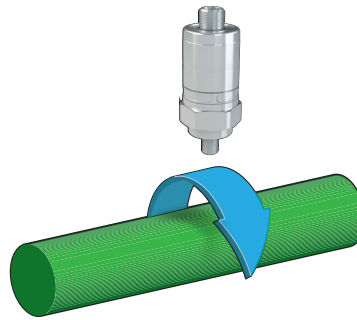
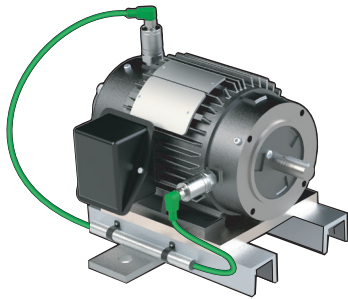

Primary direction of force for rotating equipment is radial to rotation.

## Vibration Evaluation Zones

DIN ISO 10816 defines typical evaluation zones used for qualitative assessment of the vibration on a given machine.

**Zone A:** The vibration of newly commissioned machines would normally fall within this zone.

**Zone B:** Machines with vibration within this zone are normally considered acceptable for unrestricted long-term operation.

**Zone C:** Machines with vibration within this zone are normally considered unsatisfactory for long-term continuous operation. Generally, the machine may be operated for a limited period in this condition until a suitable opportunity arises for remedial action.

**Zone D:** Vibration values within this zone are normally considered to be of sufficient severity to cause damage to the machine.

Zone boundary limits for specific machine types are provided in DIN ISO 10816. For machine types not defined in the standard, DIN ISO 10816 includes the following table of typical zone boundary ranges. In general, small machines (electric motors with power up to 15 kW) tend to lie at the lower end of the range and larger machines (prime movers with flexible supports in the direction of measurement) tend to lie at the upper end of the range. Caution should be exercised when applying the typical values given in the table as there may be specific factors (position and direction of measurement, frequency range, support flexibility and operating conditions) associated with a particular machine which would require the use of different values.

Range of typical zone boundary values RMS vibration velocity mm/s				
0.28				0.28
0.45				0.45
0.71				0.71
1.12	Zone boundary A/B 0.71 to 4.5			1.12
1.8				1.8
2.8		Zone boundary B/C 1.8 to 9.3		2.8
4.5				4.5
7.1			Zone boundary C/D 4.5 to 14.7	7.1
9.3				9.3
11.2				11.2
14.7				14.7
18				18
28				28
45				45

# prosense® Vibration Monitoring

## Vibration Velocity Transmitter or Switch and a PLC

A PLC can continuously monitor the 4-20mA output of a vibration velocity transmitter. The analog 4-20mA output allows detection of rising vibration levels before reaching a warning or alarm point and can be used to easily trend overall machine health over time. The digital output of a vibration switch allows for remote or local vibration warning or alarm limit indication and can be used to initiate equipment shut down. With analog or digital inputs from the vibration sensor, the PLC can be programmed for ALARM and TRIP points to notify plant personnel that action is required or to initiate equipment shut down.

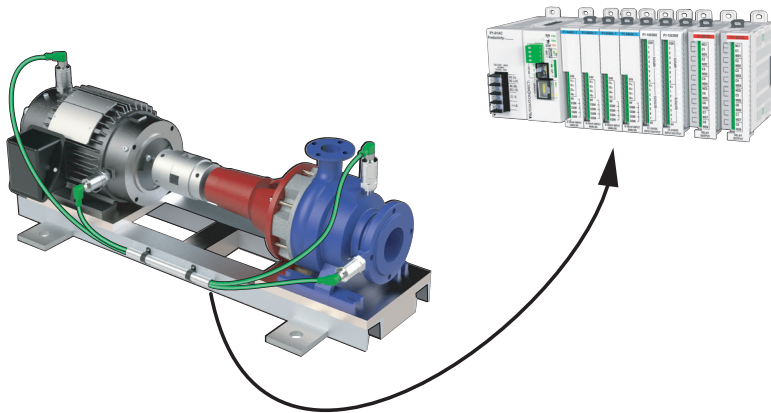

**ALARMS:** Used to provide a warning that action may be necessary when vibration limits have been reached, or a significant change has occurred, at which action may be necessary. The ALARM values can vary considerably, up or down, for different machines. The values chosen will normally be set relative to a baseline value determined from experience for the measurement position for that particular machine. Where there is no established baseline (e.g. with a new machine), the initial ALARM setting should be based either on experience with other similar machines or relative to agreed acceptance values based on DIN ISO 10816.

**TRIPS:** Used to specify the magnitude of vibration beyond which further operation of the machine can cause damage. The values used are generally the same for all machines of similar design and would not normally be related to the steady-state baseline value used for setting ALARMS.

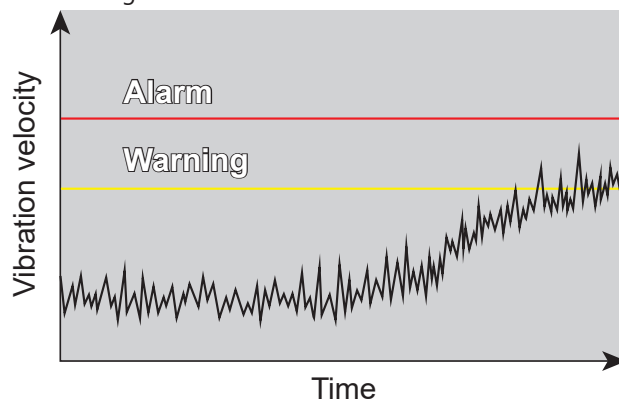



# VCST Series Vibration Switch/Transmitters



Part No. [VCST-25-1000](#)

The ProSense VCST Sensors provide overall vibration monitoring of typical industrial machinery, allowing for implementation of predictive maintenance strategies. These Microelectromechanical system (MEMS) based sensors provide vibration sensing to standard DIN ISO 10816. Available with vibration velocity ranges of 0 to 25 mm/s RMS or 0 to 50 mm/s RMS, the VCST sensors have a frequency range of 10 to 1000 Hz, suitable for most industrial machines with motor speeds of 600 to 3000 rpm. The analog 4-20mA output allows detection of rising vibration levels before reaching a warning or alarm point and can be used to easily trend overall machine health over time. The digital output PNP switch allows for remote or local vibration warning or alarm limit indication and can be used to initiate equipment shut down. The digital output switch trip point and switch delay are easily set with rotating setting rings. Mounting is accomplished with an integral M8x1.25 threaded stud and various mounting block accessories. Green and yellow LEDs indicate power and switching status.

## Features

- Overall vibration monitoring of typical industrial machinery allowing for predictive maintenance strategies
- Vibration sensing to standard DIN ISO 10816
- Vibration velocity ranges of 0 to 25 mm/s RMS or 0 to 50 mm/s RMS
- Frequency range of 10 to 1000 Hz
- MEMS based vibration sensor
- Analog 4-20 mA output
- Digital output PNP switch trip point and switch delay are easily set with rotating setting rings
- Integral M8x1.25 threaded mounting stud
- Mounting accessories include single- and two-axis mounting blocks, adhesive mounting base, magnetic mounting base
- Green and yellow LEDs indicate power and switching status
- 18 to 32 VDC operating voltage
- -25 to 80°C (-13 to 176°F) ambient temperature
- IP 67 environmental protection rating



For a variety of cable options see our website  
[www.AutomationDirect.com](http://www.AutomationDirect.com)

## ProSense VCST Series Vibration Switch / Transmitter Selection Guide

Model	Price	Measuring Range	Frequency Range	Process Connection	Electrical Connection	Operating Voltage	Output 1	Output 2
<a href="#">VCST-25-1000</a>	\$190.00	0 to 25 mm/s RMS	10 to 1,000 Hz	M8 x 1.25 male threaded	4-pin M12 quick-disconnect	18 to 32 VDC	Digital Switch	Analog 4-20mA
<a href="#">VCST-50-1000</a>	\$190.00	0 to 50 mm/s RMS						

# pro<sup>o</sup>sense® VCST Series Vibration Switch/Transmitters

ProSense VCST Series Vibration Switch / Transmitter Specifications		
Model	<u>VCST-25-1000</u>	<u>VCST-50-1000</u>
Price	\$190.00	\$190.00
Drawing Link	<a href="#">PDF</a>	<a href="#">PDF</a>
<b>Application</b>		
Application	Vibration monitor to DIN ISO 10816	
Measuring Range of Vibration	0 to 25 mm/s (RMS)	0 to 50 mm/s (RMS)
Frequency Range	10-1000 HZ	
Number of Measurement Axes	1	
<b>Electrical Data</b>		
Operating Voltage	18 to 32 VDC	
Current Consumption	< 50mA	
Protection Class	III	
Type of Sensor	Microelectromechanical system (MEMS)	
<b>Outputs</b>		
Outputs	OUT1: Digital; OUT2: Analog	
Electrical Design	PNP	
Number of Digital Outputs	1	
Output Function	Normally closed	
Max. voltage drop switching output DC	2V	
Permanent Current Rating of Switching Output DC	500mA	
Number of Analog Outputs	1	
Analog Output	4 to 20 mA Max load: 500Ω	
Short-Circuit Protection	Yes (non-latching)	
Overload Protection	Yes	
<b>Accuracy / Deviations</b>		
Measuring Error	< ±3; (% of the final value)	
Switch Point Accuracy	< ±4; (% of the final value)	
Repeatability	< 0.5; (% of the final value)	
Linearity deviation	0.25 %	
<b>Reaction Times</b>		
Response Time	1 to 60 s	
<b>Setpoint</b>		
Adjustment of The Switching & Reset Points	Setting rings	
<b>Operating Conditions</b>		
Ambient Temperature	-13 to 176°F (-25 to 80°C) [UL application: < 80°C]	
Storage Temperature	-13 to 176°F (-25 to 80°C)	
Protection	IP 67	
Approvals	cULus File # E197592, CE	

# pro<sup>sense</sup>® VCST Series Vibration Switch/Transmitters

ProSense VCST Series Vibration Switch / Transmitter Specifications Continued		
Model	VCST-25-1000	VCST-50-1000
	<b>Tests / Approvals</b>	
<b>EMC</b>	EN 61000-4-2 ESD: 4 kV CD / 8 kV AD	
	EN 61000-4-3 HF radiated: 10V/m	
	EN 61000-4-4 Burst: 2kV	
	EN 61000-4-6 HF conducted: 10V	
<b>Shock resistance</b>	400 g	
	<b>Mechanical Data</b>	
<b>Weight</b>	0.24 lbs	
<b>Type of Mounting</b>	M8 x 1.25 male	
<b>Material</b>	PBT; PC; FPM; stainless steel (1.4404 / 316L)	
<b>Tightening Torque</b>	15Nm	
	<b>Displays / Operating Elements</b>	
<b>Display</b>	Power: LED, green	
	Switching status: LED, yellow	
<b>With Scale</b>	Yes	
	<b>Electrical Connection</b>	
<b>Connector</b>	1 x 4-pin M12 quick-disconnect	

## Wiring Diagram

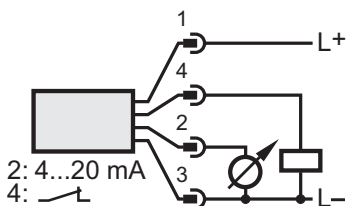

### Cable Assembly Wiring Colors:

- Pin 1 - L+ Brown
- Pin 2 - 4-20mA White
- Pin 3 - GND Blue
- Pin 4 - Digital Output Black

Colors to DIN EN 60947-5-2

For additional wiring details see individual product manuals.



Click or scan the above QR code to be taken to the manual for the VCST Series Vibration Switch / Transmitters

## Output Functions

- Output 1: Digital
- Output 2: Analog output

Note: Wiring colors are based on AutomationDirect CD12L and CD12M 4-pole cable assemblies.

# proense® VCT Series Vibration Transmitters

Part No. [VCT-25-1000](#)

The ProSense VCT transmitters provide overall vibration monitoring of typical industrial machinery, allowing for implementation of predictive maintenance strategies. These microelectromechanical system (MEMS) based sensors provide vibration sensing to standard DIN ISO 10816. Available with vibration velocity ranges of 0 to 25 mm/s RMS or 0 to 50 mm/s RMS, the VCT transmitters have a frequency range of 10 to 1000 Hz, suitable for most industrial machines with motor speeds of 600 to 3000 rpm. The analog 4-20mA output allows detection of rising vibration levels before reaching a warning or alarm point and can be used to easily trend overall machine health over time. The rugged stainless steel housing with an environmental protection rating of IP 67, 69, or 69K, depending on the IP rating of the cable used, and a wide ambient temperature range of -22 to 257°F make the VCT series transmitters ideal for harsh industrial applications. Mounting is accomplished with either the 1/4"-28 UNF / M8 or the 1/4"-28 UNF threaded adapter and various mounting block accessories.

## Features

- Overall vibration monitoring of typical industrial machinery allowing for predictive maintenance strategies
- Vibration sensing to standard DIN ISO 10816
- Vibration velocity ranges of 0 to 25 mm/s RMS or 0 to 50 mm/s RMS
- Frequency range of 10 to 1000 Hz
- MEMS based vibration sensor
- Analog 4-20 mA output
- 1/4"-28 UNF / M8 and 1/4"-28 UNF threaded adapter is included
- Mounting accessories include single- and two-axis mounting blocks, adhesive mounting base, magnetic mounting base
- 9.6 to 32 VDC operating voltage
- Stainless steel housing for harsh industrial applications
- -30 to 125°C (-22 to 257°F) ambient temperature
- IP 67/68/69K environmental protection rating



For a variety of cable options see our website  
[www.AutomationDirect.com](http://www.AutomationDirect.com)

## ProSense VCT Series Vibration Transmitter Selection Guide

Model	Price	Measuring Range	Frequency Range	Process Connection	Electrical Connection	Operating Voltage	Output
<a href="#">VCT-25-1000</a>	\$205.00	0 to 25 mm/s RMS	10 to 1,000 Hz	1/4"-28 UNF female*	4-pin M12 quick-disconnect	9.6 to 32 VDC	Analog 4-20mA
<a href="#">VCT-50-1000</a>	\$205.00	0 to 50 mm/s RMS					

\* Includes (1) 1/4"-28 UNF / M8 X 1.25 mm and (1) 1/4"-28 UNF threaded adapters

# proSense® VCT Series Vibration Transmitters

ProSense VCT Series Vibration Transmitter Specifications		
Model	VCT-25-1000	VCT-50-1000
Price	\$205.00	\$205.00
Drawing Link	<a href="#">PDF</a>	<a href="#">PDF</a>
<b>Application</b>		
Application	Vibration monitor to DIN ISO 10816	
Measuring Range of Vibration	0 to 25 mm/s (RMS)	0 to 50 mm/s (RMS)
Frequency Range	10-1000 HZ	
Number of Measurement Axes	1	
<b>Electrical Data</b>		
Operating Voltage	9.6 to 32 VDC	
Current Consumption	< 50mA	
Protection Class	III	
Type of Sensor	Microelectromechanical system (MEMS)	
<b>Outputs</b>		
Number of Analog Outputs	1	
Analog Output	4 to 20 mA Max. load < (Supply - 9.6 V) x 50; Supply = 24 V: 720Ω	
<b>Accuracy / Deviations</b>		
Measuring Error	< ±3; (% of the final value)	
Repeatability	< 0.5; (% of the final value)	
Linearity Deviation	0.25 %	
<b>Operating Conditions</b>		
Ambient Temperature	-22 to 257°F (-30 to 125°C) [UL application: < 80°C]	
Storage Temperature	-22 to 257°F (-30 to 125°C)	
Protection	IP 67; IP 68; IP 69K (depending on the IP rating of the cable used)	
Approvals	cULus File # E197592, CE	
<b>Tests / Approvals</b>		
EMC	EN 61000-6-2	
	EN 61000-6-3	
Shock Resistance	DIN EN 60068-2-27: 50g 11ms; 500g 1ms	
Vibration Resistance	DIN 60068-2-6; 20 g / 10...3000 Hz	
<b>Mechanical Data</b>		
Weight	0.27 lbs	
Type of Mounting	1/4"-28 UNF female (Includes (1) 1/4"-28 UNF / M8 X 1.25 mm and (1) 1/4"-28 UNF threaded adapters)	
Material	Stainless steel (1.4404 / 316L)	
Tightening Torque	8Nm	
<b>Electrical Connection</b>		
Connector	1 x 4-pin M12 quick-disconnect	



# proSense® VCT Series Vibration Transmitters

## Mounting Options

The ProSense VCT transmitters can be mounted with either the 1/4"-28 UNF / M8 (2) or the 1/4"-28 UNF (3) threaded adapter inserted into the unit's 1/4"-28 UNF female threads (1). Both adapters are supplied. See the VCT Series Vibration Transmitter manual for further information.

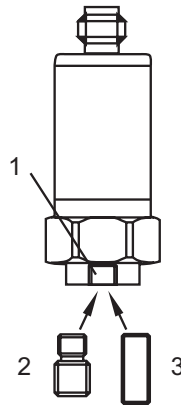

## Wiring Diagram

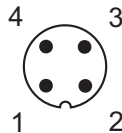
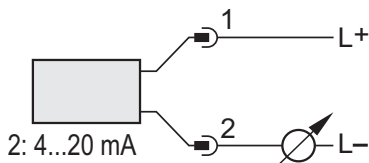

**Cable Assembly Wiring Colors:**  
 Pin 1 - L+ Brown  
 Pin 2 - 4-20mA White  
 VCT50-1000 Pin 3 - not used

**Colors to DIN EN 60947-5-2**

**For additional wiring details see individual product manuals.**

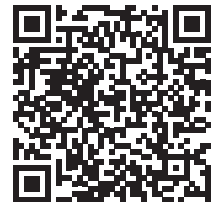

*Click or scan the above QR code to be taken to the manual for the VCT Series Vibration Transmitters*

## Output Functions

**Output:**  
**Analog output**





*Note: Wiring colors are based on AutomationDirect CD12L and CD12M 4-pole cable assemblies.*

# pro<sup>o</sup>sense® Vibration Switch/Transmitter Accessories

## Mounting Accessories

Mounting accessories aid in acquiring an accurate signal by providing VCST Series and VCT Series sensor positioning options using magnetic, adhesive, or bolt-on mounting configurations. The magnetic mount ([VC-M8](#)) should be used with ferrous metal surfaces. The adhesive mounting base ([VC-A8](#)) can be used when there is not a ferrous metal surface to mount to. The adhesive mounting base should be used with an adhesive that is suitable for use with stainless steel and the mounting surface material. Either the magnetic mount or the

adhesive mounting base is a good option when drilling and tapping a mounting hole is not possible or convenient. The single axis ([VC-S1](#)) and two axis ([VC-S2](#)) mounting blocks can easily be bolted to motor housings, providing a convenient and sturdy mounting spot for monitoring machine vibrations. The protective cover ([PSD-CV](#)) fits over the VCST Series sensor to protect from oil, other materials, or damage and helps prevent unwanted setpoint changes.

ProSense Vibration Switch / Transmitter Accessories					
Item Photo	Part No.	Description	Weight (lbs)	Price	Drawing Link
	<a href="#">VC-M8</a>	ProSense magnetic mounting base, for use with ProSense vibration sensors.	0.34	\$59.00	<a href="#">PDF</a>
	<a href="#">VC-A8</a>	ProSense adhesive mounting base, for use with ProSense vibration sensors.	0.07	\$12.00	<a href="#">PDF</a>
	<a href="#">VC-S1</a>	ProSense single axis mounting block, for use with ProSense vibration sensors.	0.09	\$42.00	<a href="#">PDF</a>
	<a href="#">VC-S2</a>	ProSense two axis mounting block, for use with ProSense vibration sensors.	0.15	\$44.00	<a href="#">PDF</a>
	<a href="#">PSD-CV</a>	Protective cover, plastic. For use with ProSense series PSD25, TSD25 and VCST process switches.	0.01	\$3.75	<a href="#">PDF</a>