



CPS Series Cylinder Position Switches

The NITRA CPS Series of cylinder position switches offers a robust, yet cost-effective, interface between pneumatic or hydraulic actuators and electrical control systems. Using state-of-the-art magnetic sensing technology, these switches are designed for use with cylinders that have a magnet incorporated in the cylinder piston. They can be used to provide cylinder position indication, cycle count, or to confirm operation.

NITRA cylinder position switches are now available in nine styles with accessories to fit many different styles of cylinders or actuators. The switches are designed for general purpose applications on most popular cylinder brands with sensor grooves, on round body cylinders using CPSB Series mounting bands or on tie rod cylinders using CPSA Series adapters. Harsh duty applications can use the CPSF Series switches with CPSS stainless steel mounting bands if needed.

NITRA cylinder position switches are available in 3-wire DC, PNP normally open, PNP normally closed, and NPN normally open electronic solid state configurations. Switches include integral cable with either an M8 or M12 wiring connector or wire leads. Integral

LED indication provides switch status for speedy switch positioning and troubleshooting. Pre-tested for use with NITRA pneumatic cylinders, these switches are also suitable for use with other brands of cylinders with magnetic pistons.

Features

- Electronic switch output, PNP (normally open or normally closed) or NPN (normally open)
- Solid state reliability, no moving parts for longer life
- AMR sensing technology with small hysteresis for precise sensing
- GMR sensing technology for basic industrial applications
- Compact and easy to mount on round body, tie rod, and extruded body cylinders
- LED switch status indication
- Integral cable with M8 or M12 wiring connector or 2-meter wire leads
- Electronic switch performance at reed switch prices



CPSB Band Assembly



CPSA Adapter Assembly



E-series cylinder with switch

Technology Comparison

Reed Switch vs. AutomationDirect CPS Series Electronic Switch			
	Mechanical Reed Switch	AutomationDirect CPS Series Electronic Switch	Details
Durability	low (1-2 million cycles typical)	high (virtually unlimited number of cycles)	Reed switches can stick, break, bounce and are prone to wear
Repeatability	low	high	Mechanical wear of reed switches can lead to switch point drift
Response time	low	high	Reed switches have a slower response time than electronic switches, resulting in lower switch accuracy
Sensitivity to magnetic fields	low	high	Electronic sensors, more sensitive than reed switches, operate reliably even with weak magnetic fields
Temperature stability	high	high	Both switch technologies are extremely stable over the entire temperature range
Longevity	low	high	Electronic sensors are insensitive to long term effects of magnetic fields. Reed switches can become permanently magnetized over time.
Response sensitivity	medium	high	Electronic sensors have small hysteresis and are exceptional for short stroke cylinders
Price	low	low	Reed switches are usually much less expensive than electronic switches. The AutomationDirect CPS Series offers all the advantages of an electronic cylinder position switch at reed switch prices.

AMR vs. GMR Technology

Two solid state magnetic sensing technologies used for pneumatic cylinder position are GMR (Giant Magnetoresistive) and AMR (Anisotropic Magnetoresistive). Both sensing technologies consist of layers of ferromagnetic material that change in electrical

resistance when exposed to an external magnetic field. AMR based switches have a higher sensitivity and narrower sensing field compared to less expensive GMR based switches. AMR switches are a better choice for cylinders with short strokes.



CPS Series Cylinder Position Switches

Position Switch Cross Reference Chart			
NITRA Switch Type	Cylinder Brand (may fit some of these cylinders)	Photo Example	Groove Illustration
CPS CPSF	NITRA A-Series NITRA D-Series NITRA F-Series		
CPS9C	DE-STA-CO Robohand SMC Compact Air Bimba Fabco		
CPS9D	NITRA L-Series Fabco Numatics Rotomation		
CPS9E	NITRA L-Series Fabco Numatics Rotomation		
CPS9F	NITRA G-Series Fabco Festo Numatics Rotomation		
CPS9H	NITRA E-Series NITRA H-Series		
CPS9M	Norgren		
CPS9Q	NITRA L-Series NITRA G-Series Parker Fabco Festo Numatics Rotomation		



CPS Series Cylinder Position Switches

NITRA CPS Series cylinder position switches use AMR sensing technology for use with cylinders having a magnetic piston. The switches are designed to mount on cylinders with a 5mm square T-slot channel. Using CPSA adapters or CPSB mounting bands, they can be used with tie rod or round body style cylinders. 3-year warranty.



Switches include switch stop and wire retainer for T-slot mounting



Wiring

NITRA CPS Series Cylinder Position Switches

Part No.	Description	Price	Weight (lbs)
CPS-AP-F	Magnetic cylinder switch for position sensing of pneumatic or hydraulic cylinders, normally open, 3-wire, 10-30 VDC, electronic PNP transistor output, status LED, 0.3 meter (1 ft) cable with M8 snap-fit connector. Can be mounted on cylinders with T-slots or round body cylinders using a CPSB series mounting band or on tie rod cylinders using a CPSA series rod adapter.	\$24.00	0.1
CPS-CP-F	Magnetic cylinder switch for position sensing of pneumatic or hydraulic cylinders, normally closed, 3-wire, 10-30 VDC, electronic PNP transistor output, status LED, 0.3 meter (1 ft) cable with M8 snap-fit connector. Can be mounted on cylinders with T-slots or round body cylinders using a CPSB series mounting band or on tie rod cylinders using a CPSA series rod adapter.	\$24.00	0.1
CPS-AN-F	Magnetic cylinder switch for position sensing of pneumatic or hydraulic cylinders, normally open, 3-wire, 10-30 VDC, electronic NPN transistor output, status LED, 0.3 meter (1 ft) cable with M8 snap-fit connector. Can be mounted on cylinders with T-slots or round body cylinders using a CPSB series mounting band or on tie rod cylinders using a CPSA series rod adapter.	\$24.00	0.1
CPS-AP-A	Magnetic cylinder switch for position sensing of pneumatic or hydraulic cylinders, normally open, 3-wire, 10-30 VDC, electronic PNP transistor output, status LED, 2 meter (6.56 ft) cable with wire leads. Can be mounted on cylinders with T-slots or round body cylinders using a CPSB series mounting band or on tie rod cylinders using a CPSA series rod adapter.	\$23.00	0.1
CPS-CP-A	Magnetic cylinder switch for position sensing of pneumatic or hydraulic cylinders, normally closed, 3-wire, 10-30 VDC, electronic PNP transistor output, status LED, 2 meter (6.56 ft) cable with wire leads. Can be mounted on cylinders with T-slots or round body cylinders using a CPSB series mounting band or on tie rod cylinders using a CPSA series rod adapter.	\$23.00	0.1
CPS-AN-A	Magnetic cylinder switch for position sensing of pneumatic or hydraulic cylinders, normally open, 3-wire, 10-30 VDC, electronic NPN transistor output, status LED, 2 meter (6.56 ft) cable with wire leads. Can be mounted on cylinders with T-slots or round body cylinders using a CPSB series mounting band or on tie rod cylinders using a CPSA series rod adapter.	\$23.00	0.1

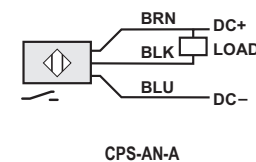
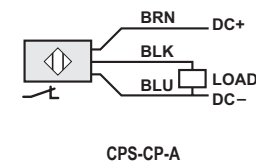
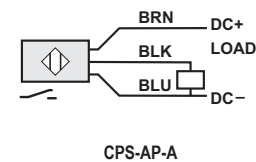
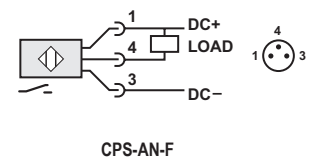
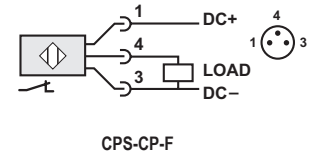
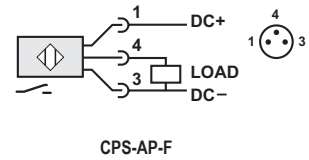

Dimensions

mm [inches]

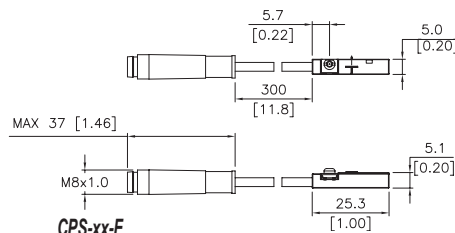
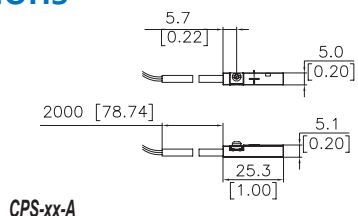



CPSF Series Cylinder Position Switches

NITRA CPSF Series cylinder position switches are designed for food and beverage or washdown applications. The switches are designed to mount on cylinders with a 5mm square T-slot channel. Using CPSSA adapters or CPSS all stainless steel mounting bands, they can be used with tie rod or round body style cylinders. 3-year warranty.

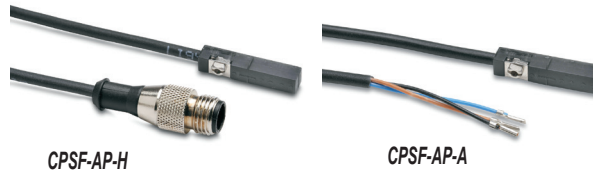

NITRA CPSF Series Cylinder Position Switches			
Part No.	Description	Price	Weight (lbs)
CPSF-AP-H	Magnetic cylinder switch for position sensing of pneumatic or hydraulic cylinders, IP69K, normally open, 3-wire, 10-30 VDC, electronic PNP transistor output, status LED, 0.3 meter (1 ft) cable with M12 connector. Can be mounted on cylinders with T-slots or round body cylinders using a CPSS series mounting band or on tie rod cylinders using a CPSSA series rod adapter.	\$28.50	0.1
CPSF-AP-A	Magnetic cylinder switch for position sensing of pneumatic or hydraulic cylinders, IP69K, normally open, 3-wire, 10-30 VDC, electronic PNP transistor output, status LED, 2 meter (6.56 ft) cable with wire leads. Can be mounted on cylinders with T-slots or round body cylinders using a CPSS series mounting band or on tie rod cylinders using a CPSSA series rod adapter.	\$26.50	0.1

Wiring

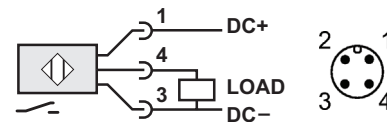

CPSF-AP-H

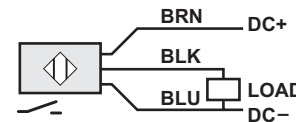

CPSF-AP-A

NITRA CPSF Cylinder Switch Specifications	
Operating Voltage	10-30 VDC
Voltage Drop	< 2.5 V
Current Rating	100 mA (built-in overload protection)
Wire Size	26AWG (0.13mm ²)
Short Circuit Protection	Yes
Reverse Polarity Protection	Yes
Overload Protection	Yes
Leakage Current	none
Sensing Technology	AMR
Hysteresis	< 1 mm
Function Display	Switching status yellow
Switching Frequency	> 6,000 Hz for 3-wire
Magnetic Sensitivity	2 millitesla (20 gauss)
Housing Materials	polyamide and stainless steel
Operating Temperature	-13°F to 185°F (-25°C to 85°C)
Protection Rating	IP 69K
Agency Approvals	CE, cULus (Class 2 source required), file E328811

Dimensions

mm [inches]

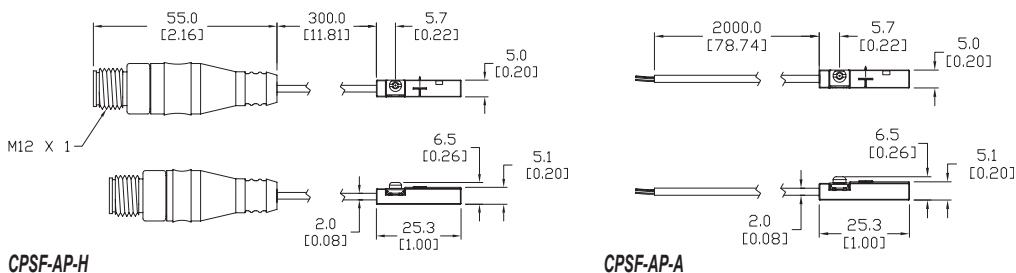



CPSA Series Cylinder Position Switches – Mounting Adapter

NITRA CPSA Series mounting adapters are made of extruded aluminum. They are used to mount CPS or CPSF series T-slot switches to tie rod style cylinders. They come in five sizes to fit tie rods from 1/8 inch [3mm] to 3/4 inch [20mm] diameter.

NITRA Cylinder Switch Mounting Adapters			
Part No.	Description	Price	Weight (lbs)
CPSA-03	Adapter bracket to secure a T-slot cylinder position switch to a 1/8 to 3/16 inch (3 to 5 mm) diameter tie rod	\$6.75	0.1
CPSA-04	Adapter bracket to secure a T-slot cylinder position switch to a 3/16 to 1/4 inch (5 to 7mm) diameter tie rod	\$7.50	0.1
CPSA-07	Adapter bracket to secure a T-slot cylinder position switch to a 3/16 to 7/16 inch (5 to 11 mm) diameter tie rod	\$6.75	0.1
CPSA-09	Adapter bracket to secure a T-slot cylinder position switch to a 3/8 to 9/16 inch (9 to 15 mm) diameter tie rod	\$6.75	0.1
CPSA-12	Adapter bracket to secure a T-slot cylinder position switch to a 9/16 to 3/4 inch (14 to 20 mm) diameter tie rod	\$8.75	0.1



Assembly photo shows CPSA mounting adapter with T-slot cylinder position switch.

Dimensions

mm [inches]

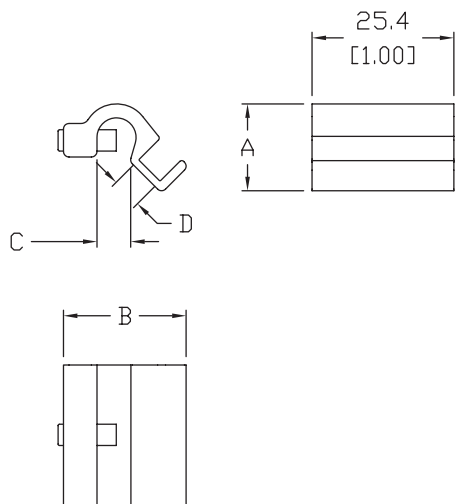

Cylinder Switch Mounting Adapter Selector*			
Nitra Cylinder Bore Size	CPSA-04	CPSA-07	CPSA-09
1-1/2"	✓	✓	
2"		✓	
2-1/2"		✓	
3-1/4"		✓	✓
4"		✓	✓

* CPSA-03 and CPSA-12 mounting adapters are for cylinder sizes that are not currently available.

CYLINDER POSITION SWITCHES				
	DIM A	DIM B	DIM C	DIM D
CPSA-03	15.5 [0.61]	22.0 [0.86]	6.0 [0.24]	5.4 [0.21]
CPSA-04	18.5 [0.73]	24.5 [0.96]	7.5 [0.30]	5.5 [0.22]
CPSA-07	22.8 [0.90]	30.2 [1.19]	11.3 [0.44]	6.6 [0.26]
CPSA-09	25.9 [1.02]	34.2 [1.35]	15.3 [0.60]	6.6 [0.26]
CPSA-12	31.1 [1.22]	39.6 [1.56]	20.3 [0.80]	6.6 [0.26]

CPSA-XX



CPSB and CPSS Series Cylinder Position Switches - Mounting Bands

NITRA Cylinder Switch SS Mounting Bands with Plastic Caps			
Part No.	Description	Price	Weight (lbs)
<u>CPSB-07</u>	Mounting band to secure a T-slot cylinder position switch to a 5/16 to 1/2 inch (8, 10, 12 mm) bore round body cylinder.	\$3.00	0.1
<u>CPSB-14</u>	Mounting band to secure a T-slot cylinder position switch to a 9/16 to 7/8 inch (16 & 20 mm) bore round body cylinder.	\$3.00	0.1
<u>CPSB-20</u>	Mounting band to secure a T-slot cylinder position switch to a 1-1/16 to 1-1/4 inch (25 & 32 mm) bore round body cylinder.	\$3.50	0.1
<u>CPSB-24</u>	Mounting band to secure a T-slot cylinder position switch to a 1-1/2 inch (40 mm) bore round body cylinder.	\$3.75	0.1
<u>CPSB-32</u>	Mounting band to secure a T-slot cylinder position switch to a 1-3/4 to 2 inch (50 mm) bore round body cylinder.	\$4.25	0.1
<u>CPSB-40</u>	Mounting band to secure a T-slot cylinder position switch to a 2-1/2 inch (63 mm) bore round body cylinder	\$4.50	0.1
<u>CPSB-52</u>	Mounting band to secure a T-slot cylinder position switch to a 3 inch (80 mm) bore round body cylinder	\$5.25	0.1
<u>CPSB-64</u>	Mounting band to secure a T-slot cylinder position switch to a 4 inch (100 mm) bore round body cylinder	\$5.25	0.1



NITRA Cylinder Switch All Stainless Steel Mounting Bands			
Part No.	Description	Price	Weight (lbs)
<u>CPSS-07</u>	Stainless steel mounting band to secure a T-slot cylinder position switch to a 7/16 to 9/16 inch (10 to 16 mm) bore round body cylinder	\$6.25	0.1
<u>CPSS-14</u>	Stainless steel mounting band to secure a T-slot cylinder position switch to a 7/8 to 1-1/16 inch (20 to 25 mm) bore round body cylinder	\$6.50	0.1
<u>CPSS-20</u>	Stainless steel mounting band to secure a T-slot cylinder position switch to a 1-1/4 inch (32 mm) bore round body cylinder	\$6.75	0.1
<u>CPSS-24</u>	Stainless steel mounting band to secure a T-slot cylinder position switch to a 1-1/2 inch (40 mm) bore round body cylinder	\$7.00	0.1
<u>CPSS-32</u>	Stainless steel mounting band to secure a T-slot cylinder position switch to a 1-3/4 to 2 inch (50 mm) bore round body cylinder	\$7.50	0.1
<u>CPSS-40</u>	Stainless steel mounting band to secure a T-slot cylinder position switch to a 2-1/2 inch (63 mm) bore round body cylinder	\$7.75	0.1
<u>CPSS-52</u>	Stainless steel mounting band to secure a T-slot cylinder position switch to a 3 inch (80 mm) bore round body cylinder	\$8.00	0.1
<u>CPSS-64</u>	Stainless steel mounting band to secure a T-slot cylinder position switch to a 4 inch (100 mm) bore round body cylinder	\$8.25	0.1

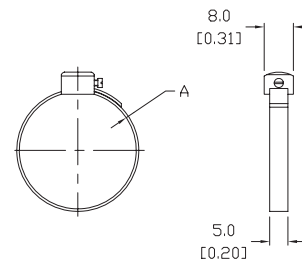

Dimensions mm [inches]

CYLINDER POSITION SWITCHES			
PART #	DIM A	PART #	DIM A
CPSX-07	ø11.0-ø19.0 [ø0.43-ø0.75]	CPSX-32	ø48.0-ø59.0 [ø1.89-ø2.32]
CPSX-14	ø18.0-ø29.0 [ø0.71-ø1.14]	CPSX-40	ø58.0-ø69.0 [ø2.28-ø2.72]
CPSX-20	ø28.0-ø39.0 [ø1.10-ø1.54]	CPSX-52	ø78.0-ø89.0 [ø3.07-ø3.50]
CPSX-24	ø38.0-ø49.0 [ø1.50-ø1.93]	CPSX-64	ø98.0-ø109.0 [ø3.86-ø4.29]

CPSX-XX



CPS9C Series Cylinder Position Switches

NITRA CPS9C Series cylinder position switches are general purpose switches for use with cylinders having a magnetic piston. The switches are designed to mount on cylinders with 4mm round slots. Position is fixed by using the supplied screw that is embedded in the switch body.



CPS9C-AP-A

CPS9C-AP-F



Wiring

NITRA CPS9C Series Cylinder Position Switches				
Part No.	Description	Price	Weight (lbs)	
CPS9C-AP-A	Pneumatic cylinder switch, for position sensing, magnetic, round, normally open, 3-wire, 5-28 VDC, electronic PNP transistor output, status LED, 9.8 ft. (3.0m) cable with wire leads. Can be mounted on cylinders with 4mm round slots.	\$17.00	0.2	
CPS9C-AN-A	Pneumatic cylinder switch, for position sensing, magnetic, round, normally open, 3-wire, 5-28 VDC, electronic NPN transistor output, status LED, 9.8 ft. (3.0m) cable with wire leads. Can be mounted on cylinders with 4mm round slots.	\$17.00	0.2	
CPS9C-AP-F	Pneumatic cylinder switch, for position sensing, magnetic, round, normally open, 3-wire, 5-28 VDC, electronic PNP transistor output, status LED, 0.5 ft. (0.15m) cable with M8 snap-fit connector. Can be mounted on cylinders with 4mm round slots.	\$17.00	0.2	
CPS9C-AN-F	Pneumatic cylinder switch, for position sensing, magnetic, round, normally open, 3-wire, 5-28 VDC, electronic NPN transistor output, status LED, 0.5 ft. (0.15m) cable with M8 snap-fit connector. Can be mounted on cylinders with 4mm round slots.	\$17.00	0.2	

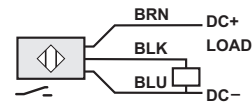

CPS9C-AP-A

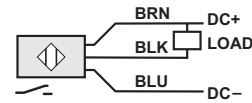

CPS9C-AN-A

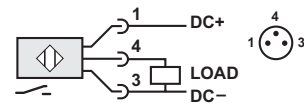

CPS9C-AP-F

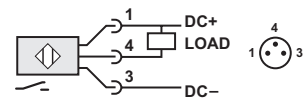

CPS9C-AN-F

NITRA CPS9C Series Cylinder Switch Specifications	
Operating Voltage	5-28 VDC
Voltage Drop	2.5 V @ 40 mA
Current Rating	0.5 Amps Max.
Wire Size	26AWG (0.14mm ²)
Cable Diameter	2.7 mm
Switching Power	14 watts Max.
Short Circuit Protection	No
Reverse Polarity Protection	Yes
Overload Protection	No
Leakage Current	< 0.01 mA
Sensing Technology	GMR
Off Delay Time	150-200 ms
Function Display	PNP switching status yellow / NPN switching status red
Switching Frequency	< 1000 Hz
Magnetic Sensitivity	4.0 millitesla (40 gauss)
Housing Materials	Cable = PVC (Polyvinyl Chloride) / Sensor = PBT (Polybutylene Terephthalate), TPU (Thermoplastic Polyurethane)
Operating Temperature	-14°F to 158°F (-10°C to 70°C)
Protection Rating	NEMA 6 / IP 67
Agency Approvals	CE, RoHS, REACH

Dimensions

mm [inches]

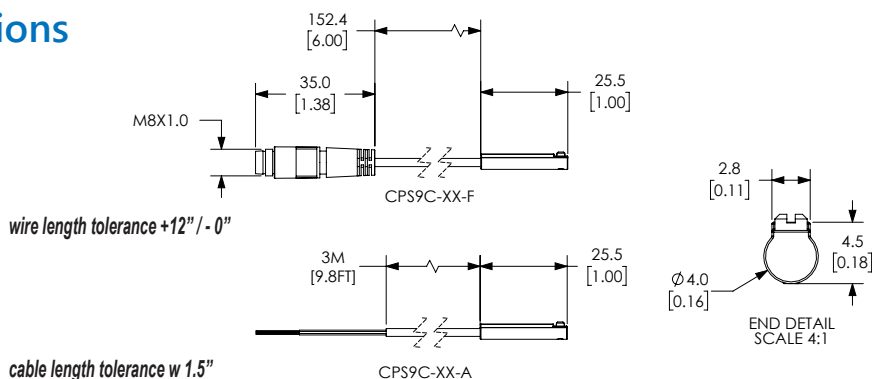

wire length tolerance +12" / - 0"

cable length tolerance w 1.5"



CPS9D Series Cylinder Position Switches

NITRA CPS9D Series cylinder position switches are general purpose switches for use with cylinders having a magnetic piston. The switches are designed to mount on cylinders with 1/4 inch 60 degree dovetail slots. The switches can be used with the CPS9D series dovetail adapters for mounting.



Wiring

NITRA CPS9D Series Cylinder Position Switches			
Part No.	Description	Price	Weight (lbs)
CPS9D-AP-A	Pneumatic cylinder switch, for position sensing, magnetic, dovetail, normally open, 3-wire, 5-28 VDC, electronic PNP transistor output, status LED, 9.8 ft. (3.0m) cable with wire leads. Can be mounted on cylinders with 1/4 inch 60 degree dovetail slots or other dovetail grooves using CPS9D-D adapters.	\$15.50	0.2
CPS9D-AN-A	Pneumatic cylinder switch, for position sensing, magnetic, dovetail, normally open, 3-wire, 5-28 VDC, electronic NPN transistor output, status LED, 9.8 ft. (3.0m) cable with wire leads. Can be mounted on cylinders with 1/4 inch 60 degree dovetail slots or other dovetail grooves using CPS9D-D adapters.	\$15.50	0.2
CPS9D-AP-F	Pneumatic cylinder switch, for position sensing, magnetic, dovetail, normally open, 3-wire, 5-28 VDC, electronic PNP transistor output, status LED, 0.5 ft. (0.15m) cable with M8 snap-fit connector. Can be mounted on cylinders with 1/4 inch 60 degree dovetail slots or other dovetail grooves using CPS9D-D adapters.	\$15.50	0.2
CPS9D-AN-F	Pneumatic cylinder switch, for position sensing, magnetic, dovetail, normally open, 3-wire, 5-28 VDC, electronic NPN transistor output, status LED, 0.5 ft. (0.15m) cable with M8 snap-fit connector. Can be mounted on cylinders with 1/4 inch 60 degree dovetail slots or other dovetail grooves using CPS9D-D adapters.	\$15.50	0.2

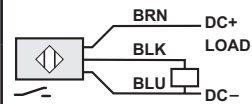

[CPS9D-AP-A](#)

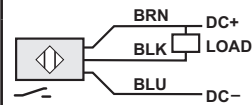

[CPS9D-AN-A](#)

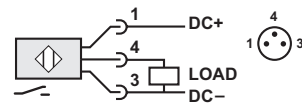

[CPS9D-AP-F](#)

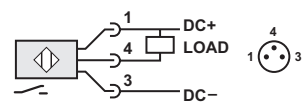

[CPS9D-AN-F](#)

NITRA CPS9D Series Cylinder Switch Specifications	
Operating Voltage	5-28 VDC
Voltage Drop	1.0 V
Current Rating	0.2 Amps Max.
Wire Size	26AWG (0.13mm ²)
Switching Power	4.8 watts Max.
Switching Speed	4µs operate / 4µs release
Short Circuit Protection	No
Reverse Polarity Protection	Yes
Overload Protection	No
Leakage Current	< 0.01 mA
Sensing Technology	GMR
Off Delay Time	150-200 ms
Function Display	PNP switching status yellow / NPN switching status red
Switching Frequency	< 1000 Hz
Magnetic Sensitivity	2.5 millitesla (25 gauss)
Housing Materials	Zytel
Operating Temperature	-4°F to 176°F (-20°C to 80°C)
Protection Rating	NEMA 6 / IP 67
Agency Approvals	CE, RoHS, REACH

Dimensions

mm [inches]

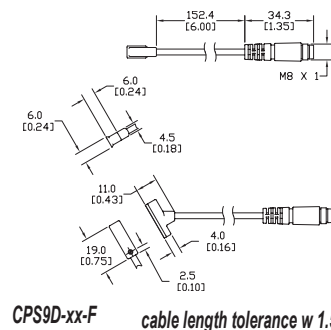
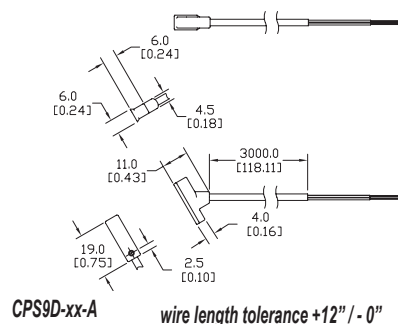



CPS9D Series Cylinder Position Switch – Accessories

Accessories



CPS9D-D12M



CPS9D-D14M



CPS9D-D38

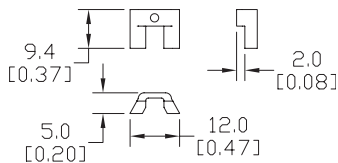

Photo example shows a CPS9D switch mounted in a dovetail groove adapter.

NITRA CPS9D/CPS9E Series Cylinder Position Switch Accessories			
Part No.	Description	Price	Weight (lbs)
<u>CPS9D-D12M</u>	Dovetail groove adapter, mounts a CPS9D/CPS9E cylinder position switch in a 12mm 60 degree dovetail slot	\$2.00	0.2
<u>CPS9D-D14M</u>	Dovetail groove adapter, mounts a CPS9D/CPS9E cylinder position switch in a 14mm 60 degree dovetail slot	\$1.75	0.2
<u>CPS9D-D38</u>	Dovetail groove adapter, mounts a CPS9D/CPS9E cylinder position switch in a 3/8 inch 60 degree dovetail slot	\$1.75	0.2

Dimensions

mm [inches]



CPS9D-D12M

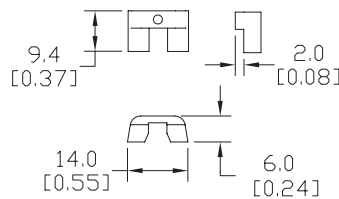

CPS9D-D14M

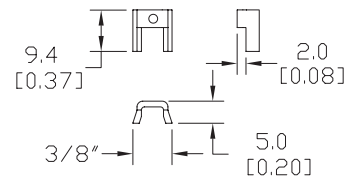

CPS9D-D38



CPS9E Series Cylinder Position Switches

NITRA CPS9E Series cylinder position switches are general purpose switches for use with cylinders having a magnetic piston. The switches are designed to mount on cylinders with 1/4 inch 60 degree dovetail slots. The switches can be used with the CPS9D series dovetail adapters for mounting.

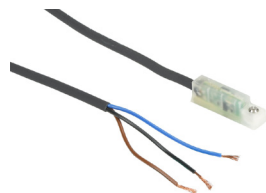

[CPS9E-AP-A](#)



[CPS9E-AP-F](#)



Wiring

NITRA CPS9E Series Cylinder Position Switches					
Part No.	Description	Drawing Link	Price	Weight (lbs)	
CPS9E-AP-A	NITRA cylinder switch, dovetail, PNP, N.O. output, 5-28 VDC operating voltage, LED indication, 9.8ft (3.00m) 3-wire pigtail with wire leads, straight cable entry, 1/4in 60 degree dovetail slot mount, for position sensing.	PDF	\$20.00	0.1	
CPS9E-AN-A	NITRA cylinder switch, dovetail, NPN, N.O. output, 5-28 VDC operating voltage, LED indication, 9.8ft (3.00m) 3-wire pigtail with wire leads, straight cable entry, 1/4in 60 degree dovetail slot mount, for position sensing.	PDF	\$20.00	0.1	
CPS9E-AP-F	NITRA cylinder switch, dovetail, PNP, N.O. output, 5-28 VDC operating voltage, LED indication, 0.5ft (0.15m) cable with 3-pin M8 snap-fit connector, straight cable entry, 1/4in 60 degree dovetail slot mount, for position sensing.	PDF	\$29.00	0.05	
CPS9E-AN-F	NITRA cylinder switch, dovetail, NPN, N.O. output, 5-28 VDC operating voltage, LED indication, 0.5ft (0.15m) cable with 3-pin M8 snap-fit connector, straight cable entry, 1/4in 60 degree dovetail slot mount, for position sensing.	PDF	\$29.00	0.05	

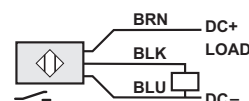

[CPS9E-AP-A](#)

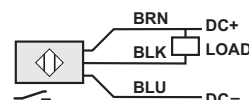

[CPS9E-AN-A](#)

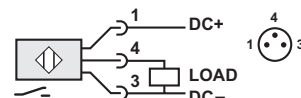

[CPS9E-AP-F](#)

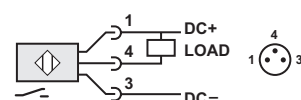

[CPS9E-AN-F](#)

NITRA CPS9E Series Cylinder Switch Specifications	
Operating Voltage	5-28 VDC
Voltage Drop	1.0 V
Current Rating	0.2 Amps Max.
Wire Size	26AWG (0.13mm ²)
Switching Power	4.8 watts Max.
Switching Speed	4μs operate / 4μs release
Short Circuit Protection	No
Reverse Polarity Protection	Yes
Overload Protection	No
Leakage Current	< 0.01 mA
Sensing Technology	GMR
Off Delay Time	150-200 ms
Function Display	PNP switching status yellow / NPN switching status red
Switching Frequency	< 1000 Hz
Magnetic Sensitivity	2.5 millitesla (25 gauss)
Housing Materials	Zytel
Operating Temperature	-4°F to 176°F (-20°C to 80°C)
Protection Rating	NEMA 6 / IP 67
Agency Approvals	CE, RoHS, REACH



CPS9D/CPS9E Series Cylinder Position Switch – Accessories

Accessories



CPS9D-D12M



CPS9D-D14M



CPS9D-D38

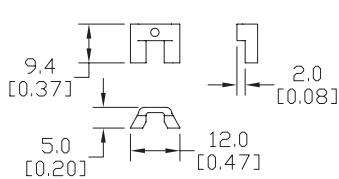

Photo example shows a CPS9D switch mounted in a dovetail groove adapter.

NITRA CPS9D/CPS9E Series Cylinder Position Switch Accessories			
Part No.	Description	Price	Weight (lbs)
<u>CPS9D-D12M</u>	Dovetail groove adapter, mounts a CPS9D/CPS9E cylinder position switch in a 12mm 60 degree dovetail slot	\$2.00	0.2
<u>CPS9D-D14M</u>	Dovetail groove adapter, mounts a CPS9D/CPS9E cylinder position switch in a 14mm 60 degree dovetail slot	\$1.75	0.2
<u>CPS9D-D38</u>	Dovetail groove adapter, mounts a CPS9D/CPS9E cylinder position switch in a 3/8 inch 60 degree dovetail slot	\$1.75	0.2

Dimensions

mm [inches]



CPS9D-D12M

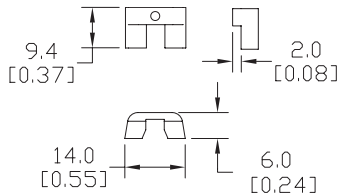

CPS9D-D14M

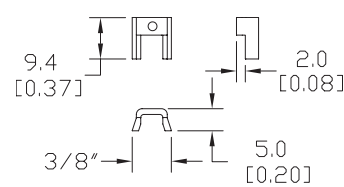

CPS9D-D38



CPS9F Series Cylinder Position Switches

NITRA CPS9F Series cylinder position switches are general purpose switches for use with cylinders having a magnetic piston. The switches are designed to mount on cylinders with 6.5 x 3.2 mm T-slots.

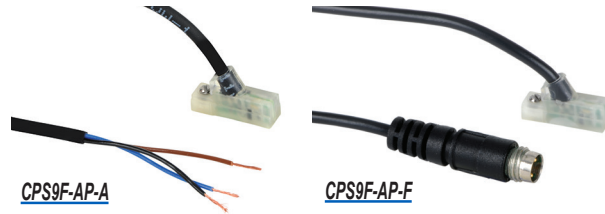

Wiring

NITRA CPS9F Series Cylinder Position Switches			
Part No.	Description	Price	Weight (lbs)
CPS9F-AP-A	Pneumatic cylinder switch, for position sensing, magnetic, rectangular, normally open, 3-wire, 5-28 VDC, electronic PNP transistor output, status LED, 9.8 ft. (3.0m) cable with wire leads. Can be mounted on cylinders with 6.5 x 3.2 mm T-slots.	\$17.50	0.2
CPS9F-AN-A	Pneumatic cylinder switch, for position sensing, magnetic, rectangular, normally open, 3-wire, 5-28 VDC, electronic NPN transistor output, status LED, 9.8 ft. (3.0m) cable with wire leads. Can be mounted on cylinders with 6.5 x 3.2 mm T-slots.	\$17.50	0.2
CPS9F-AP-F	Pneumatic cylinder switch, for position sensing, magnetic, rectangular, normally open, 3-wire, 5-28 VDC, electronic PNP transistor output, status LED, 0.5 ft. (0.15m) cable with M8 snap-fit connector. Can be mounted on cylinders with 6.5 x 3.2 mm T-slots.	\$17.50	0.2
CPS9F-AN-F	Pneumatic cylinder switch, for position sensing, magnetic, rectangular, normally open, 3-wire, 5-28 VDC, electronic NPN transistor output, status LED, 0.5 ft. (0.15m) cable with M8 snap-fit connector. Can be mounted on cylinders with 6.5 x 3.2 mm T-slots.	\$17.50	0.2

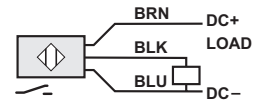

[CPS9F-AP-A](#)

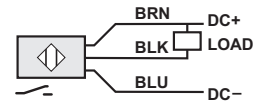

[CPS9F-AN-A](#)

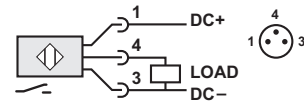

[CPS9F-AP-F](#)

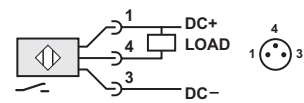

[CPS9F-AN-F](#)

NITRA CPS9F Series Cylinder Switch Specifications	
Operating Voltage	5-28 VDC
Voltage Drop	1.0 V
Current Rating	0.2 Amps Max.
Wire Size	26AWG (0.13mm ²)
Switching Power	4.8 watts Max.
Switching Speed	4µs operate / 4µs release
Short Circuit Protection	No
Reverse Polarity Protection	Yes
Overload Protection	No
Leakage Current	< 0.01 mA
Sensing Technology	GMR
Off Delay Time	150-200 ms
Function Display	PNP switching status yellow / NPN switching status red
Switching Frequency	< 1000 Hz
Magnetic Sensitivity	2.5 millitesla (25 gauss)
Housing Materials	Zytel
Operating Temperature	-4°F to 176°F (-20°C to 80°C)
Protection Rating	NEMA 6 / IP 67
Agency Approvals	CE, RoHS, REACH

Dimensions

mm [inches]

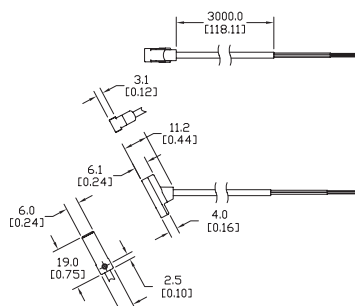

[CPS9F-xx-A](#) wire length tolerance +12" / - 0"

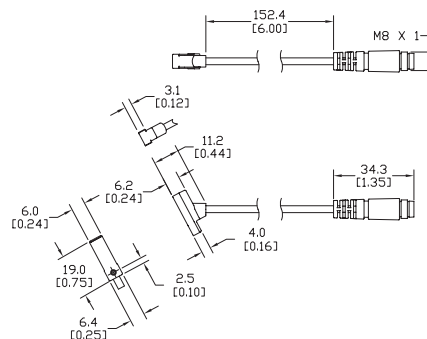

[CPS9F-xx-F](#) cable length tolerance w 1.5"



CPS9H Series Cylinder Position Switches

NITRA CPS9H Series cylinder position switches are general purpose switches for use with cylinders having a magnetic piston. The switches are designed to mount on cylinders with 4mm square T-slots.



CPS9H-AP-A

CPS9H-AP-F

Wiring

NITRA CPS9H Series Cylinder Position Switches			
Part No.	Description	Price	Weight (lbs)
CPS9H-AP-A	Pneumatic cylinder switch, for position sensing, magnetic, square, normally open, 3-wire, 5-28 VDC, electronic PNP transistor output, status LED, 9.8 ft. (3.0m) cable with wire leads. Can be mounted on cylinders with 4mm square T-slots.	\$24.50	0.2
CPS9H-AN-A	Pneumatic cylinder switch, for position sensing, magnetic, square, normally open, 3-wire, 5-28 VDC, electronic NPN transistor output, status LED, 9.8 ft. (3.0m) cable with wire leads. Can be mounted on cylinders with 4mm square T-slots.	\$24.50	0.2
CPS9H-AP-F	Pneumatic cylinder switch, for position sensing, magnetic, square, normally open, 3-wire, 5-28 VDC, electronic PNP transistor output, status LED, 0.5 ft. (0.15m) cable with M8 snap-fit connector. Can be mounted on cylinders with 4mm square T-slots.	\$24.50	0.2
CPS9H-AN-F	Pneumatic cylinder switch, for position sensing, magnetic, square, normally open, 3-wire, 5-28 VDC, electronic NPN transistor output, status LED, 0.5 ft. (0.15m) cable with M8 snap-fit connector. Can be mounted on cylinders with 4mm square T-slots.	\$24.50	0.2

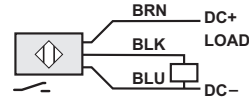

CPS9H-AP-A

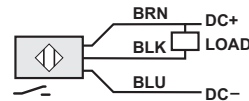

CPS9H-AN-A

NITRA CPS9H Series Cylinder Switch Specifications	
Operating Voltage	5-28 VDC
Voltage Drop	0.5 V @ 500 mA
Current Rating	0.5 Amps Max.
Wire Size	26AWG (0.13mm ²)
Switching Power	14 watts Max.
Short Circuit Protection	No
Reverse Polarity Protection	Yes
Overload Protection	No
Leakage Current	< 0.01 mA
Sensing Technology	GMR
Off Delay Time	150-200 ms
Function Display	PNP switching status yellow / NPN switching status red
Switching Frequency	< 1000 Hz
Magnetic Sensitivity	4 millitesla (40 gauss)
Housing Materials	ABS
Operating Temperature	-14°F to 158°F (-10°C to 70°C)
Protection Rating	NEMA 6 / IP 67
Agency Approvals	CE, RoHS, REACH

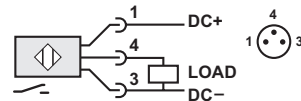

CPS9H-AP-F

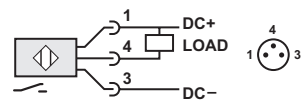

CPS9H-AN-F

Dimensions

mm [inches]

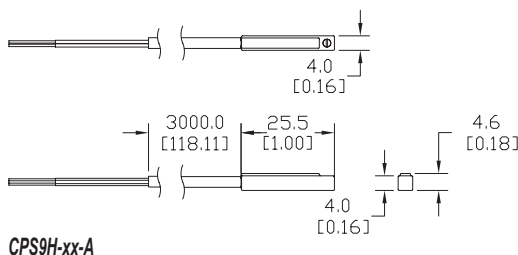

CPS9H-xx-A

wire length tolerance +12" / - 0"

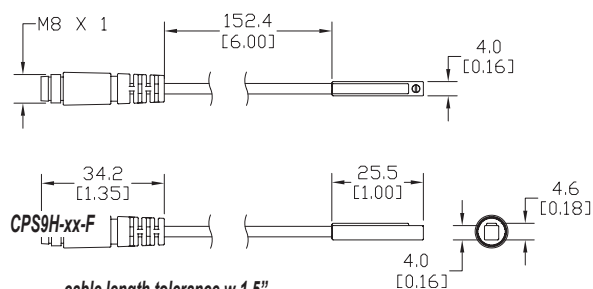

CPS9H-xx-F

cable length tolerance w 1.5"



CPS9M Series Cylinder Position Switches

NITRA CPS9M Series cylinder position switches are general purpose switches for use with cylinders having a magnetic piston. The switches are designed to mount on cylinders with 1/4 inch round slots.



CPS9M-AP-A

CPS9M-AP-F

Wiring

NITRA CPS9M Series Cylinder Position Switches			
Part No.	Description	Price	Weight (lbs)
CPS9M-AP-A	Pneumatic cylinder switch, for position sensing, magnetic, round, normally open, 3-wire, 5-28 VDC, electronic PNP transistor output, status LED, 9.8 ft. (3.0m) cable with wire leads. Can be mounted on cylinders with 1/4 inch round slots.	\$18.50	0.2
CPS9M-AN-A	Pneumatic cylinder switch, for position sensing, magnetic, round, normally open, 3-wire, 5-28 VDC, electronic NPN transistor output, status LED, 9.8 ft. (3.0m) cable with wire leads. Can be mounted on cylinders with 1/4 inch round slots.	\$18.50	0.2
CPS9M-AP-F	Pneumatic cylinder switch, for position sensing, magnetic, round, normally open, 3-wire, 5-28 VDC, electronic PNP transistor output, status LED, 0.5 ft. (0.15m) cable with M8 snap-fit connector. Can be mounted on cylinders with 1/4 inch round slots.	\$18.50	0.2
CPS9M-AN-F	Pneumatic cylinder switch, for position sensing, magnetic, round, normally open, 3-wire, 5-28 VDC, electronic NPN transistor output, status LED, 0.5 ft. (0.15m) cable with M8 snap-fit connector. Can be mounted on cylinders with 1/4 inch round slots.	\$18.50	0.2

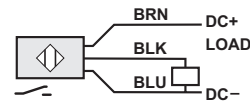

CPS9M-AP-A

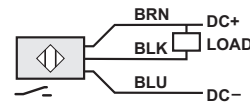

CPS9M-AN-A

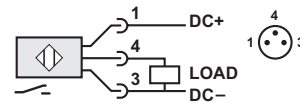

CPS9M-AP-F

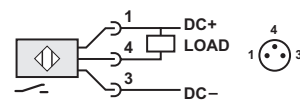

CPS9M-AN-F

NITRA CPS9M Series Cylinder Switch Specifications	
Operating Voltage	5-28 VDC
Voltage Drop	1.0 V @ 200 mA
Current Rating	0.2 Amps Max.
Wire Size	26AWG (0.13mm ²)
Switching Power	4.8 watts Max.
Short Circuit Protection	No
Reverse Polarity Protection	Yes
Overload Protection	No
Leakage Current	< 0.01 mA
Sensing Technology	GMR
Off Delay Time	150-200 ms
Function Display	PNP switching status yellow / NPN switching status red
Switching Frequency	< 1000 Hz
Magnetic Sensitivity	2.5 millitesla (25 gauss)
Housing Materials	ABS
Operating Temperature	-14°F to 158°F (-10°C to 70°C)
Protection Rating	NEMA 6 / IP 67
Agency Approvals	CE, RoHS, REACH

Dimensions

mm [inches]

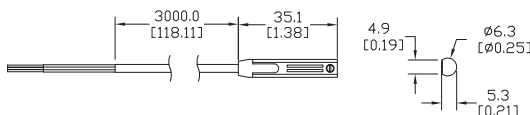

CPS9M-xx-A wire length tolerance +12" / - 0"

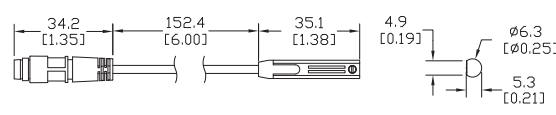

CPS9M-xx-F cable length tolerance w 1.5"



CPS9Q Series Cylinder Position Switches

NITRA CPS9Q Series cylinder position switches are general purpose switches for use with cylinders having a magnetic piston. The switches are designed to mount on cylinders with a 6.5 x 3.2 mm T-slot channel.



CPS9Q-AP-A

CPS9Q-AP-F



Wiring

NITRA CPS9Q Series Cylinder Position Switches			
Part No.	Description	Price	Weight (lbs)
CPS9Q-AP-A	Pneumatic cylinder switch, for position sensing, magnetic, rectangular, normally open, 3-wire, 5-28 VDC, electronic PNP transistor output, status LED, 9.8 ft. (3.0m) cable with wire leads. Low profile housing that can be mounted on cylinders with 6.5 x 3.2 mm T-slots.	\$19.00	0.2
CPS9Q-AN-A	Pneumatic cylinder switch, for position sensing, magnetic, rectangular, normally open, 3-wire, 5-28 VDC, electronic NPN transistor output, status LED, 9.8 ft. (3.0m) cable with wire leads. Low profile housing that can be mounted on cylinders with 6.5 x 3.2 mm T-slots.	\$19.00	0.2
CPS9Q-AP-F	Pneumatic cylinder switch, for position sensing, magnetic, rectangular, normally open, 3-wire, 5-28 VDC, electronic PNP transistor output, status LED, 0.5 ft. (0.15m) cable with M8 snap-fit connector. Low profile housing that can be mounted on cylinders with 6.5 x 3.2 mm T-slots.	\$19.00	0.2
CPS9Q-AN-F	Pneumatic cylinder switch, for position sensing, magnetic, rectangular, normally open, 3-wire, 5-28 VDC, electronic NPN transistor output, status LED, 0.5 ft. (0.15m) cable with M8 snap-fit connector. Low profile housing that can be mounted on cylinders with 6.5 x 3.2 mm T-slots.	\$19.00	0.2

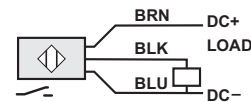

CPS9Q-AP-A

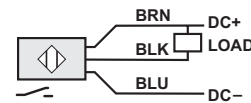

CPS9Q-AN-A

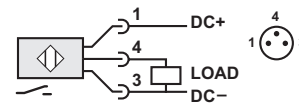

CPS9Q-AP-F

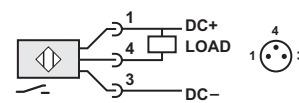

CPS9Q-AN-F

NITRA CPS9Q Series Cylinder Switch Specifications	
Operating Voltage	5-28 VDC
Voltage Drop	1.0 V
Current Rating	0.2 Amps Max.
Wire Size	26AWG (0.13mm ²)
Switching Power	4.8 watts Max.
Switching Speed	4μs operate / 4μs release
Short Circuit Protection	No
Reverse Polarity Protection	Yes
Overload Protection	No
Leakage Current	< 0.01 mA
Sensing Technology	GMR
Off Delay Time	150-200 ms
Function Display	PNP switching status yellow / NPN switching status red
Switching Frequency	< 1000 Hz
Magnetic Sensitivity	2.5 millitesla (25 gauss)
Housing Materials	Ultem
Operating Temperature	-4°F to 176°F (-20°C to 80°C)
Protection Rating	NEMA 6 / IP 67
Agency Approvals	CE, RoHS, REACH

Dimensions

mm [inches]

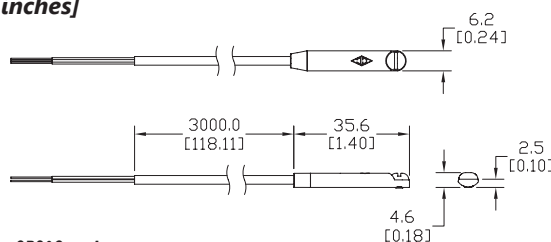

CPS9Q-xx-A

wire length tolerance +12" / - 0"

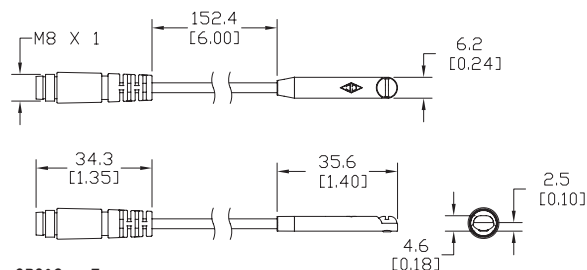

CPS9Q-xx-F

cable length tolerance w 1.5"