

Enclosure Accessories – Miscellaneous

Shipping Schedule				
Same day	1 - 5 days	1 - 7 days	1 - 15 days	1 - 20 days
Color indicates shipping lead time in business days.				



Locking Protective Cover

Features

- Packaged multi-purpose protective cover
- Locking door
- Weather and UV-resistant (UL 94-HB)
- IP 20 Protection Class
- Includes mounting screws



Locking Protective Cover	Description	Price
086110-00	Stego multi-purpose protective cover with locking door, weather and UV-resistant (UL 94-HB), IP20 protection class. Includes mounting screws and keys.	\$49.00

Dimensions

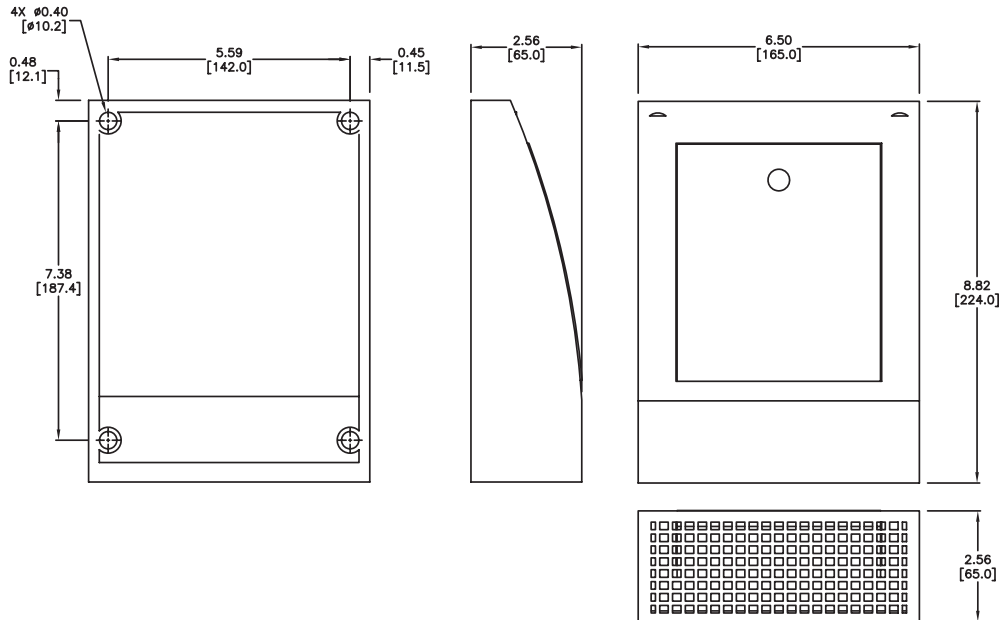

Ecoline Enclosure LED Lights Magnet, Clip, or Screw Mounted



Magnet Mount



Screw Mount



Clip Mount

Applications

- Suitable for all types of panels and enclosures, especially where space is at a premium
- Suitable for daisy-chaining
- Allows for up to 10 lights to be connected to each other

Features

- Energy saving LED technology
- Available with magnet, clip, or screw mounts allowing them to be easily positioned in any enclosure
- Magnet mount has powerful non-slip rubberized magnets and work on ferrous steel only
- Clip mount has specifically designed clip holders for clip mount of the LED 025. The light is snapped into the clip holders and can be rotated 180°
- Wide voltage range
- Dual cage clamp for quick wiring



Listings

- UL File No. E234324
- CE, VDE, EAC

Ecoline Enclosure LED Lights							
Magnet Mount	Price	Screw Mount	Price	Clip Mount	Price	Operating Voltage	Switch Type
025403-10	\$71.00	025403-11	\$60.00	025403-13	\$60.00	AC 100 - 240V, 50/60 Hz (min. 90V, max. 265V) DC 90 - 110V (min. 80V, max. 125V)	On/Off
025413-10	\$138.00	025413-11	\$126.00	025413-13	\$126.00	AC 100 - 240V, 50/60 Hz (min. 90V, max. 265V) DC 90 - 110V (min. 80V, max. 125V)	PIR motion sensor
025423-10	\$70.00	025423-11	\$58.00	025423-13	\$58.00	AC 100 - 240V, 50/60 Hz (min. 90V, max. 265V) DC 90 - 110V (min. 80V, max. 125V)	—
025401-10	\$94.00	025401-11	\$82.00	025401-13	\$82.00	DC 24-48 (min. 20V, max. 60V)	On/Off switch
025411-10	\$173.00	025411-11	\$161.00	025411-13	\$161.00	DC 24-48 (min. 20V, max. 60V)	PIR motion sensor
025421-10	\$92.00	025421-11	\$81.00	025421-13	\$81.00	DC 24-48 (min. 20V, max. 60V)	—

Ecoline Enclosure LED Lights Specifications	
Power Consumption	Max. 5W (~75 W incandescent bulb)
Luminosity	400 Lm at 120° (1,200 Lm at 360° or equivalent 95 W light bulb)
Lamp Type	LED, 120° angle of radiation light color – daylight, color temperature – 6,000 to 7,000 K
Service Life	60,000 hrs. at 68°F [20°C]
Connection	2-pole dual cage clamp for 14 AWG [2.5mm] solid wire and 16 AWG [1.5 mm ²] stranded wire wire end ferrule
Housing	plastic, transparent
Mounting	Magnet mount Screw mount (M5 screws not included) Clip mount (M6 screws not included)
Operating / Storage Temperature	-22 to 140°F [-30 to 60°C] / -40 to 185°F [-40 to 85°C]
Operating / Storage Humidity	max. 90% RH (non-condensing)
Protection Class	II (double insulated)
Protection Type	IP20
Approvals	CE, UL Recognized File No.: E234324, VDE, EAC, RoHS 2 compliant
Weight	approx. 7 oz. [200 g]



Connection End

Ecoline Enclosure LED Lights Magnet, Clip, or Screw Mounted



Dimensions

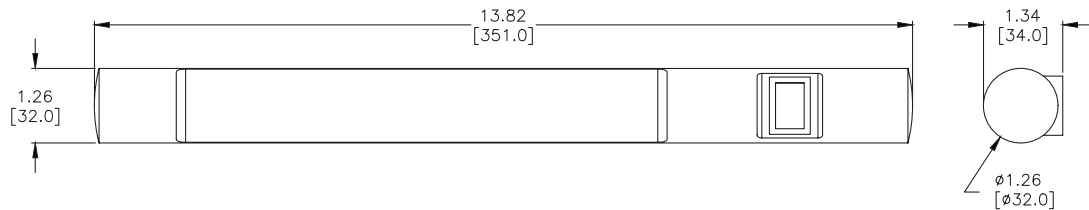

Magnet Mount

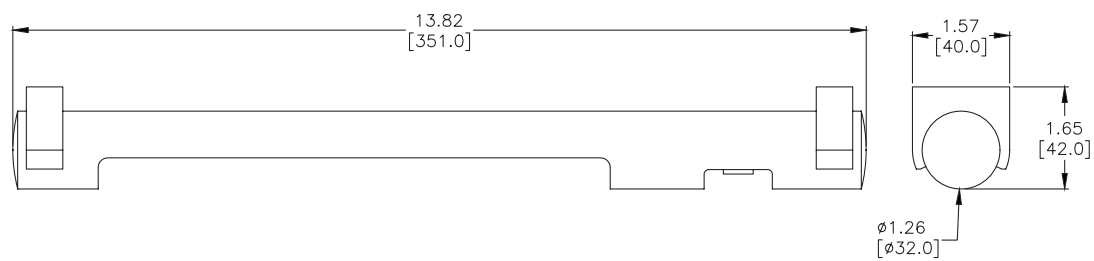

Clip Mount

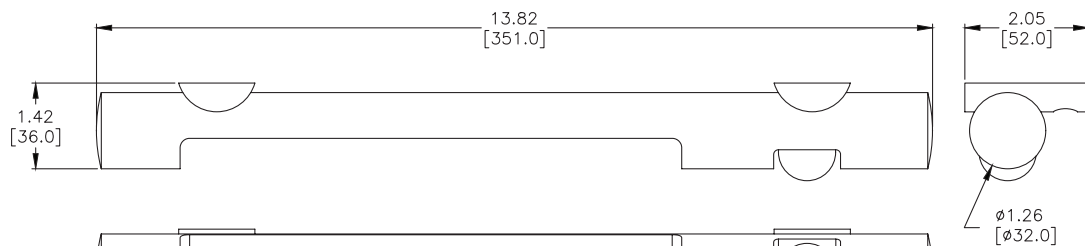

Screw Mount

Enclosure LED Lights Magnet or Screw Mounted



Magnet mount

Applications

- Suitable for all types of panels and enclosures, especially where space is at a premium
- Suitable for daisy-chaining
- Allows for up to 10 lights to be connected to each other

Features

- Energy saving LED technology
- Available with magnet or screw mounts allowing them to be easily positioned in any enclosure
- Magnet mount has powerful non-slip rubberized magnets and work on ferrous steel only
- Wide voltage range



Listings

- UL File No. E234324
- CE, VDE, EAC



Screw mount

Enclosure LED Lights Specifications	
Power Consumption	Max. 5W (~75 W incandescent bulb)
Luminosity	400 Lm at 120° (1,200 Lm at 360° or equivalent 95 W light bulb)
Lamp Type	LED, 120° angle of radiation light color – daylight, color temperature – 6,000 to 7,000 K
Service Life	60,000 hrs. at 68°F [20°C]
Connection	2-pole plug with snap lock (order separately)
Housing	plastic, transparent
Mounting	Magnet or M5 screws (not included), 9.8" (250 mm) centers
Operating / Storage Temperature	-22 to 140°F [-30 to 60°C] / -40 to 185°F [-40 to 85°C]
Operating / Storage Humidity	max. 90% RH (non-condensing)
Protection Class	II (double insulated)
Protection Type	IP20
Approvals	CE, UL Recognized File No.: E234324, VDE, EAC, RoHS 2 compliant

Enclosure LED Lights					
Magnet Mount	Price	Screw Mount	Price	Operating Voltage	Switch Type
025400-00	\$107.00	025400-01	\$93.00	100-240 VAC, 50/60 Hz (min. 90 VAC, max. 265 V)	On/Off Switch ²
025401-00	\$162.00	025401-01	\$149.00	24-48 VDC (min. 20 VDC, max. 60 VDC)	
025410-00	\$181.00	025410-01	\$168.00	100-240 VAC, 50/60 Hz (min. 90 VAC, max. 265 V)	PIR Motion Sensor ^{1,3}
025411-00	\$248.00	025411-01	\$235.00	24-48 VDC (min. 20 VDC, max. 60 VDC)	

Notes: ¹Passive Infrared (PIR) motion sensor is factory preset to turn the light OFF five minutes after all action ceases.
²Weight: 0.30 lb [135 g]
³Weight: 0.31 lb [140 g]

Dimensions

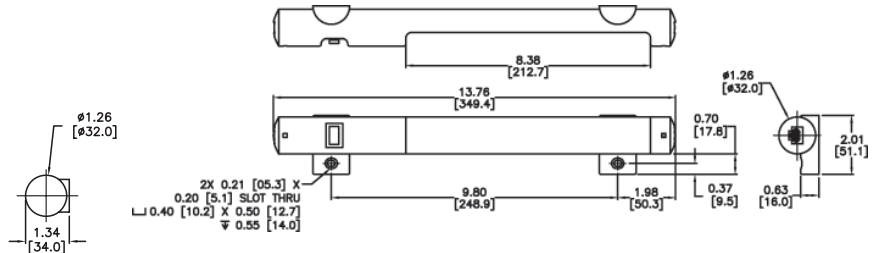
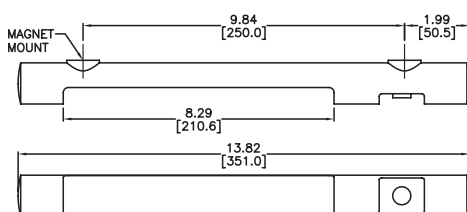

Enclosure Accessories – LED Light Accessories



Power cable with input connector and wire leads



Part Number	Price	Description	Length	Voltage	Color
244357	\$28.00	Connection cable 2 x 15 AWG with input connector	6.5 ft (2.0 m)	AC	Connectors: white; Cable: white
244361	\$28.00	Connection cable 2 x 15 AWG with input connector		DC	Connectors: blue; Cable: white

Extension cable with 2 connectors for daisy chain (input and output) connection



Part Number	Price	Description	Length	Voltage	Color
244359	\$33.50	Extension cable 2 x 15 AWG with 2 connectors	3.2 ft (1.0 m)	AC	Connectors: white; Cable: white
244363	\$33.50	Extension cable 2 x 15 AWG with 2 connectors		DC	Connectors: blue; Cable: white

Power Input and Output Connectors

(Field Wireable)

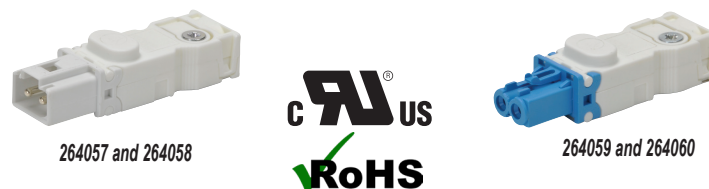

Part Number	Price	Description	Voltage	Color
264057	\$9.00	Input connector	AC	White
264058	\$8.50	Output connector		
264059	\$9.00	Input connector	DC	Blue
264060	\$8.50	Output connector		

Varioline Enclosure LED Lights



Applications

The Varioline is a powerful and compact LED lamp capable of fully illuminating even very large enclosures. The glare-free, 360° rotatable LED tube uses mid-power LEDs with a service life of 60,000 hours. The emitted daylight color of 6,500K provides safety for the user by a natural and non-fading color reproduction.

Features

- High luminous flux
- Integrated power unit
- Durable and maintenance-free LED technology
- Available in 15.75in [400 mm] and 23.63in [600 mm] lengths
- Up to eight units can be daisy-chained
- On/off switch, motion sensor or unswitched
- Magnet or screw mounting for easy positioning
- Uses Varioline cable and connectors

Listings

- UL Recognized File E234324



LED 021 Movement sensor and screw mount 021000-00



LED 022 On/off switch and magnet mount 022000-30

Varioline Enclosure LED Lights Specifications		
Length	Size 1	Size 2
		15.75in [400 mm]
Power Consumption	11W Max.	16W Max.
Operating Voltage	AC 100 - 240V, 50/60 Hz (min. AC 90V, max. AC 265V)	
Luminosity	1,080 Lm	1,730 Lm
Lamp Type	LED	
Angle of Radiation	120°	
Light Color	Daylight	
Color Temperature	6,500 K	
Service Life	60,000 hrs. at 68°F [20°C]	
Connection	2-pole connector with snap lock; AC: max. 2.5A / AC 240V, color: white	
Housing	plastic, translucent	
Mounting Hardware (screw mount only)	M5 screws, 2 lb·in max. torque	
Operating Temperature	-22 to 104°F [-30 to 40°C]	
Storage Temperature	-40 to 185°F [-40 to 85°C]	
Operating / Storage Humidity	max. 90% RH (non-condensing)	
Protection Class	II (double insulated)	
Protection Type	IP20	
Approvals	UL Recognized File E234324, VDE, CE	
Weight	Approx. 7.1 oz [0.2 kg]	Approx. 10.6 oz [0.3 kg]

Varioline Enclosure LED Lights



Varioline Enclosure LED Lights						
Size 1 – 15.75in [400 mm] length						
Magnet Mount	Price	Drawing Link	Screw Mount	Price	Drawing Link	Switch Type
021000-30	\$141.00	PDF	021100-00	\$133.00	PDF	on/off
021100-30*	\$191.00	PDF	021100-00	\$184.00	PDF	PIR motion sensor
021200-30	\$137.00	PDF	021200-00	\$129.00	PDF	no

*Approximately 5 minute fixed switch-on duration.

Varioline Enclosure LED Lights						
Size 2 – 23.63in [600 mm] length						
Magnet Mount	Price	Drawing Link	Screw Mount	Price	Drawing Link	Switch Type
022000-30	\$157.00	PDF	022000-00	\$149.00	PDF	on/off
022100-30*	\$207.00	PDF	022100-00	\$200.00	PDF	PIR motion sensor
022200-30	\$153.00	PDF	022200-00	\$145.00	PDF	no

*Approximately 5 minute fixed switch-on duration.

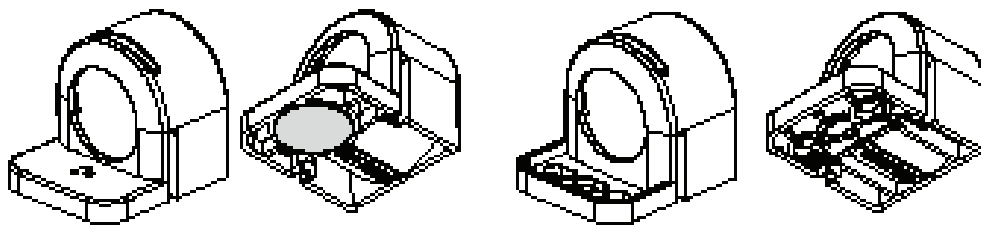

View of Magnet Mount

View of Screw Mount

Close up view

Accessories – Varioline Enclosure LED Lights



Power cable with input connector and wire leads



244357

Part Number	Price	Description	Length	Voltage	Color
244357	\$28.00	Connection cable 2 x 16 AWG with input connector	6.5ft (2.0 m)	AC	Connectors: white; Cable: white

Power Input and Output Connectors

(Field Wireable)



264057

Part Number	Price	Description	Voltage	Color
264057	\$9.00	Input Connector	AC	White
264058	\$8.50	Output Connector		

Extension Cable with 2 Connectors (Input and Output) for Daisy Chain Connection



244359

Part Number	Price	Description	Length	Voltage	Color
244359	\$33.50	Extension cable 2 x 15 AWG with 2 connectors	3.2 ft (1.0 m)	AC	Connectors: white; Cable: white

Accessories – Varioline Enclosure LED Lights with Socket



**LED 121 On/Off Switch and
screw mount 121040-00**

Applications

The Varioline is a powerful and compact LED light capable of illuminating even very large enclosures in their full depth and height. Its integrated socket allows for the power connection of laptops and diagnostic devices. The glare-free, 120° rotatable light tube uses mid-power LEDs with a service life of 60,000 hours. The emitted daylight color of 6,500K provides safety for the user by a natural and non-fading color reproduction.

Features

- High luminous flux
- Integrated socket
- Integrated power unit
- Durable and maintenance-free LED technology
- Up to eight units can be daisy-chained
- On/off switch, motion sensor, connection for external door switch or unswitched
- Magnet or screw mount

Listings

- UL Recognized File E234324



**LED 122 Movement Sensor and
magnet mount 122040-30**



Varioline Enclosure LED Lights with Socket Specifications		
	Size 1	Size 2
Length	19.68in [500mm]	27.56in [700mm]
Power Consumption	11W Max.	16W Max.
Socket Nominal Current	15A	
Operating Voltage	AC 120V , 50/60 Hz (min. AC 110 , max. AC 130V)	
Luminosity	1,080 Lm	1,730 Lm
Lamp Type	LED	
Angle or Rotation	120°	
Light Color	Daylight	
Color Temperature	6,500 K	
Service Life	60,000 hrs. at 68°F [20°C]	
Connection	3-pole connector with snap lock; AC: max. 16A / AC 240V, color: white	
Housing	Plastic, transparent	
Mounting Hardware (screw mount only)	M5 screws, 2 lb-in max.	
Operating Temperature	-22 to 104°F [-30 to 40°C]	
Storage Temperature	-40 to 185°F [-40 to 85°C]	
Operating / Storage Humidity	Max. 90% RH (non-condensing)	
Protection Class	I (earthed)	
Protection Type	IP20	
Approvals	UL Recognized File E234324, VDE, CE	
Weight	Approx. 10.6 oz [0.3kg]	Approx. 14.1oz [0.4kg]

Accessories – Varioline Enclosure LED Lights with Socket



Varioline Enclosure LED Lights with Socket						
Size 1 – 19.68in [500mm]						
Magnet Mount	Price	Drawing Link	Screw Mount	Price	Drawing Link	Switch Type
121040-30	\$178.00	PDF	121040-00	\$167.00	PDF	on/off
121140-30*	\$227.00	PDF	121140-00	\$216.00	PDF	PIR motion sensor
121240-30**	\$183.00	PDF	121240-00	\$172.00	PDF	connection for external
121340-30	\$174.00	PDF	121340-00	\$163.00	PDF	no

*Approximately 5 minute fixed switch-on duration.
 ** Requires plug 264090

Varioline Enclosure LED Lights with Socket						
Size 2 – 27.56 [700mm]						
Magnet Mount	Price	Drawing Link	Screw Mount	Price	Drawing Link	Switch Type
122040-30	\$194.00	PDF	122040-00	\$183.00	PDF	on/off
122140-30*	\$243.00	PDF	122140-00	\$232.00	PDF	PIR motion sensor
122240-30**	\$199.00	PDF	122240-00	\$188.00	PDF	connection for external
122340-30	\$190.00	PDF	122340-00	\$179.00	PDF	no

*Approximately 5 minute fixed switch-on duration.
 ** Requires plug 264090

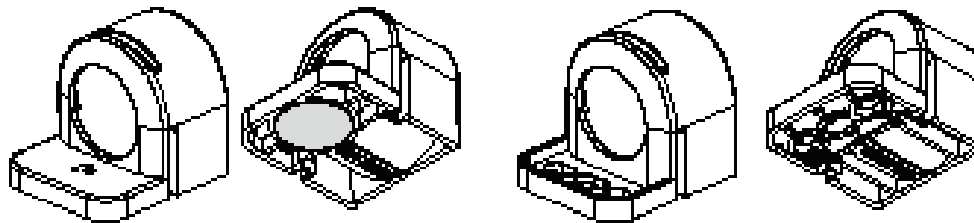

View of Magnet Mount

View of Screw Mount

Close up view

Accessories – Varioline Enclosure LED Lights with Socket



Power cable with input connector and wire leads



244423

Part Number	Price	Description	Length	Voltage	Color
244423	\$67.00	Connection cable 3 x 16 AWG with input connector	13.1 ft (4.0 m)	AC	Connectors: white; Cable: white

Varioline Power Input and Output Connectors

(Field Wireable)



264090



264091



264093

Part Number	Price	Description	Voltage	Color
264090	\$11.00	External Switch Connector	AC	Gray
264091	\$14.00	Input Connector		White
264093	\$15.50	Daisy Chain Connector		

*Required for External Connection Switch Varioline lights.

Extension Cable with 2 Connectors (Input and Output) for Daisy Chain Connection



244359

Part Number	Price	Description	Length	Voltage	Color
244359	\$33.50	Extension cable 2 x 15 AWG with 2 connectors	3.2 ft (1.0 m)	AC	Connectors: white; Cable: white

Accessories – NextGen Air Conditioners



Bolt Pack		
Part Number	Price	Description
<u>SCE-NGBOLT</u>	\$162.00	Bolt pack, replacement For use with NextGen air conditioners (8) M6 bolts, washers, and external tooth washers included



[SCE-NGBOLT](#)