

Polycarbonate Enclosures – Impact Series

Impact Series - Wall-Mount, Single-Door Enclosures



Construction

- Polycarbonate for 900 in-lb, high impact resistance
- Polycarbonate is stable and holds its tensile strength better than other non-metallic materials over a temperature range from -40°F to 265°F (-40° to 129°C)
- Standard hinges for easy door removal or replacement while permitting a full 225° door swing
- Integrated mounting flanges eliminate the need to affix the mounting feet or flange to the enclosure. Mounting flanges are molded into the enclosure
- Integrated latch provides a clean look and easy opening of the enclosure. This latch is available on all Impact enclosures

Listings

- UL/cUL 50/50E listed UL 1, 2, 3, 3R, 3S, 4, 4X, 6, 6P, 12, and 13
- UL File E207562
- Flammability Rating: UL94-5VA
- Outdoor UV Exposure Rating: UL-F1



Approvals

- To obtain the most current agency approval information, see the Agency Approval Checklist section on the specific part number's web page.

Gray in color with gloss Finish

- Available with clear or opaque door
- Extra interior mounting bosses on rear wall (and lid of opaque enclosures, except 9 x 8 x 2 in [229 x 203 x 51 mm]) provide multiple mounting options for DIN rail, back panels, or other components
- Tightening torque - 10 to 15 lb-in

Shipping Schedule

Same day 1 - 5 days 1 - 7 days 1 - 15 days 1 - 20 days

Color indicates shipping lead time in business days.

Impact Series – Polycarbonate Enclosures – Wall-Mount, Single-Door

Opaque Door	Price	Clear Door	Price	Enclosure Overall Size HxWxD	Drawing Link
P4043-P10	\$47.50	P4043C-P10	\$55.00	4.91 x 4.91 x 3.56 [125 x 125 x 90]	PDF
P6063-P10	\$60.00	P6063C-P10	\$69.00	6.54 x 6.54 x 4.01 [166 x 166 x 102]	PDF
P8063-P10	\$70.00	P8063C-P10	\$79.00	8.54 x 6.54 x 4.01 [217 x 166 x 102]	PDF
P9082-P10	\$83.00	P9082C-P10	\$97.00	9.54 x 8.54 x 3.51 [242 x 217 x 89]	PDF
P10086-P10	\$105.00	P10086C-P10	\$122.00	10.54 x 8.54 x 7.01 [268 x 217 x 178]	PDF

Note: Subpanels must be ordered separately.
Dimensions in inches [millimeters].

Polycarbonate Enclosures – Impact Series



Dimensions

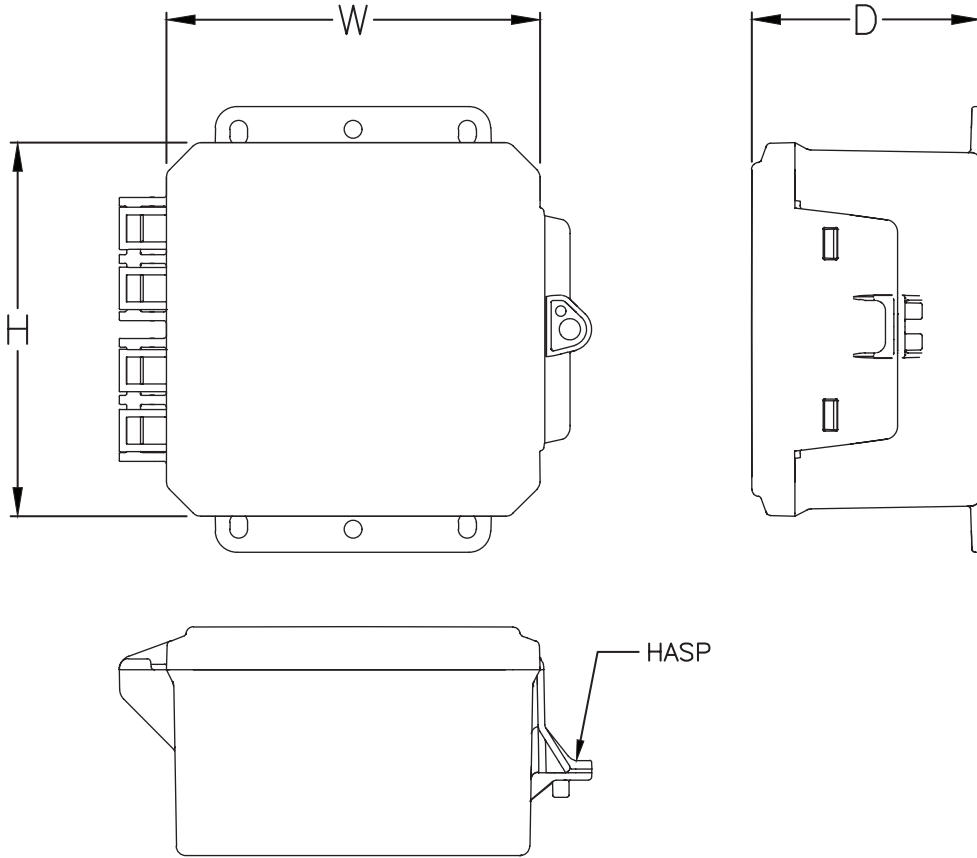

Polycarbonate Enclosures – Impact Series

Impact Series - Subpanels, Dead Front Panels, and Swing-Out Panels



Construction

- Subpanels available in aluminum, PVC, and steel with white powder coat finish
- Mounting hardware included
- Swing-out panels available in aluminum
- Advanced Dead Front Panel System: 2 brackets, 8 screws and a face plate (P606 and P806 only)
- Advanced Swing-out Panel System: 2 brackets, 10 screws, and the swing-out panel (P606 and P806 only)
- Mounting screw torque - 10 to 15 lb-in
- Aluminum panels are 0.063in [1.6mm] thick
- Painted steel panels are 0.075in [1.9mm] thick
- PVC panels are 0.187in [4.7mm] thick

Shipping Schedule

Same day	1 - 5 days	1 - 7 days	1 - 15 days	1 - 20 days
----------	------------	------------	-------------	-------------

Color indicates shipping lead time in business days.

Impact Series – Polycarbonate Enclosures – Subpanels

Aluminum	Price	Painted Steel	Price	PVC	Price	Dimension HxW	For Use With	Drawing Link
<u>ABP44-IMP-P10</u>	\$13.50	<u>SBP44-IMP-P10</u>	\$37.50	<u>PVCBP44-IMP-P10</u>	\$14.00	3.50 x 3.50 [89 x 89]	P404 enclosures	<u>PDF</u>
<u>ABP66-IMP-P10</u>	\$17.00	<u>SBP66-IMP-P10</u>	\$38.50	<u>PVCBP66-IMP-P10</u>	\$22.00	4.88 x 4.88 [124 x 124]	P606 enclosures	<u>PDF</u>
<u>ABP86-IMP-P10</u>	\$19.75	<u>SBP86-IMP-P10</u>	\$43.00	<u>PVCBP86-IMP-P10</u>	\$25.00	6.75 x 4.88 [171 x 124]	P806 enclosures	<u>PDF</u>
<u>ABP98-IMP-P10</u>	\$22.50	<u>SBP98-IMP-P10*</u>	\$44.00	<u>PVCBP98-IMP-P10</u>	\$28.50	6.88 x 6.75 [175 x 171]	P908 enclosures	<u>PDF</u>
<u>ABP108-IMP-P10</u>	\$28.00	<u>SBP108-IMP-P10**</u>	\$49.00	<u>PVCBP108-IMP-P10</u>	\$35.00	8.75 x 6.88 [222 x 175]	P1008 enclosures	<u>PDF</u>

Notes: Dimensions in inches [millimeters].

*Painted steel subpanel dimensions are 6.88 x 6.88 [175 x 175]

** Painted steel subpanel dimensions are 8.88 x 6.88 [226 x 175].

Impact Series – Polycarbonate Enclosures – Dead Front Panels

Aluminum	Price	Painted Steel	Price	Dimension HxW	For Use With
<u>AFP44-IMP-P10</u>	\$29.50	<u>SFP44-IMP-P10</u>	\$71.00	4.29 x 4.29 [109 x 109]	P404 enclosures
<u>AFP66-IMP-P10</u>	\$34.00	<u>SFP66-IMP-P10</u>	\$71.00	5.93 x 5.93 [151 x 151]	P606 enclosures
<u>AFP86-IMP-P10</u>	\$36.00	<u>SFP86-IMP-P10</u>	\$77.00	7.93 x 5.93 [201 x 151]	P806 enclosures
<u>AFP108-IMP-P10</u>	\$61.00	—	—	9.88 x 7.88 [251 x 200]	P1008 enclosures

Note: Dimensions in inches [millimeters].

Impact Series – Polycarbonate Enclosures – Swing-Out Panels

Aluminum	Price	Painted Steel	Price	Dimension HxW	For Use With
<u>ASWPK66-IMP-P10</u>	\$32.50	<u>SSWPK66-IMP-P10</u>	\$71.00	5.90 x 5.38 [150 x 137]	P606 enclosures
<u>ASWPK86-IMP-P10</u>	\$35.50	<u>SSWPK86-IMP-P10</u>	\$77.00	7.38 x 5.90 [187 x 150]	P806 enclosures
<u>ABP-108USOPK-P10</u>	\$60.00	—	—	8.75 x 6.88 [222 x 175]	H1008 and P1008 enclosures

Note: Dimensions in inches [millimeters].

Polycarbonate Enclosures – Impact Series



Dimensions

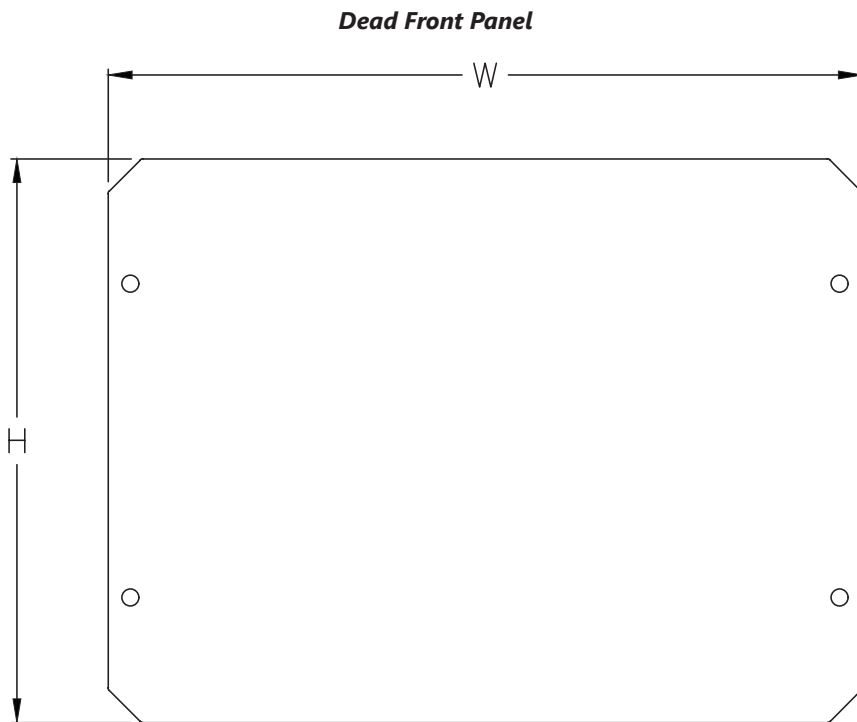
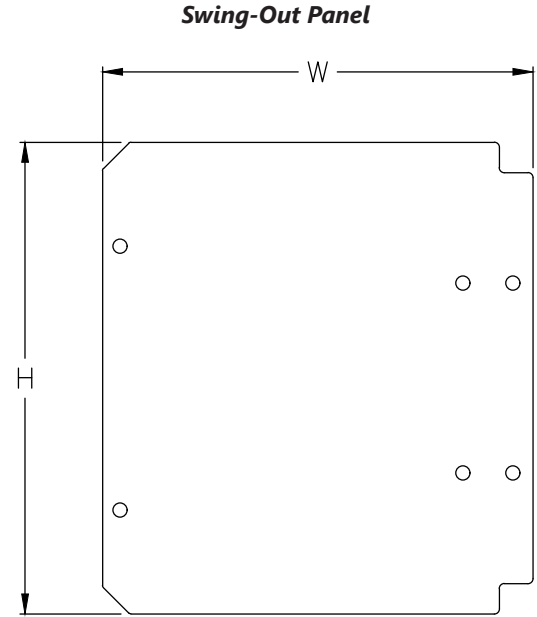
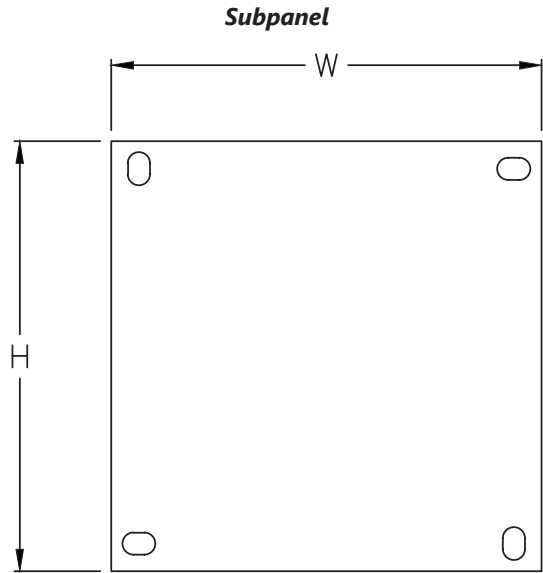

Polycarbonate Enclosures – Premium Series

Wall-Mount, Screw Cover



Construction

- Polycarbonate for 900 in-lb, high impact resistance
- Polycarbonate is stable and holds its tensile strength better than other non-metallic materials over a temperature range from -40°F to 265°F (-40° to 129°C)
- Lift-off cover with 4 screws
- Light gray in color with gloss finish
- Available with clear or opaque cover
- Extra interior mounting bosses on rear wall provide multiple mounting options for DIN rail, back panels, or other components. Tightening torque - 10 to 15 lb-in
- Includes mounting flanges with screws
- Features Integra's unique T-Rail mounting system (brackets sold separately) for dead front panels, swing-out panels, layering subpanels, and/or infinitely variable subpanel height

Listings

- UL/cUL 50/50E listed UL 1, 2, 3, 3R, 3S, 4, 4X, 6, 6P, 12, and 13
- UL File E229365
- Flammability Rating: UL94-5VA
- Outdoor UV Exposure Rating: UL-F1



Approvals

- To obtain the most current agency approval information, see the Agency Approval Checklist section on the specific part number's web page.

Shipping Schedule

Same day 1 - 5 days 1 - 7 days 1 - 15 days 1 - 20 days

Color indicates shipping lead time in business days.

Polycarbonate Enclosures – Premium Series – Wall-Mount, Screw Cover

Opaque Cover	Price	Clear Cover	Price	Enclosure Size HxWxD	Drawing Link
H6064SF-P10	\$79.00	H6064SCF-P10	\$91.00	6.54 x 6.54 x 4.82 [166 x 166 x 122]	PDF
H8064SF-P10	\$92.00	H8064SCF-P10	\$106.00	8.44 x 6.44 x 4.71 [214 x 164 x 120]	PDF
H8084SF-P10	\$106.00	H8084SCF-P10	\$120.00	8.44 x 8.44 x 4.82 [214 x 214 x 122]	PDF
H10084SF-P10	\$116.00	H10084SCF-P10	\$130.00	10.54 x 8.54 x 4.66 [268 x 217 x 118]	PDF
H10086SF-P10	\$122.00	H10086SCF-P10	\$135.00	10.54 x 8.54 x 6.66 [268 x 217 x 169]	PDF
H12104SF-P10	\$132.00	H12104SCF-P10	\$152.00	12.54 x 10.54 x 4.71 [319 x 268 x 120]	PDF
H12106SF-P10	\$143.00	H12106SCF-P10	\$165.00	12.54 x 10.54 x 6.71 [319 x 268 x 170]	PDF
H141206SF-P10	\$171.00	H141206SCF-P10	\$182.00	14.58 x 12.58 x 7.04 [370 x 320 x 179]	PDF
H161407SF-P10	\$204.00	H161407SCF-P10	\$228.00	16.70 x 14.70 x 8.04 [424 x 373 x 204]	PDF
H181610SF-P10	\$233.00	H181610SCF-P10	\$257.00	18.91 x 16.91 x 11.08 [480 x 430 x 281]	PDF

Notes: Subpanels must be ordered separately.
Dimensions in inches [millimeters].

Polycarbonate Enclosures – Premium Series

Wall-Mount, Hinged Screw Cover



Construction

- Polycarbonate for 900 in-lb, high impact resistance
- Polycarbonate is stable and holds its tensile strength better than other non-metallic materials over a temperature range from -40°F to 265°F (-40° to 129°C)
- Standard hinges for easy door removal or replacement while permitting a full 225° door swing
- Hinged cover with 4 screws
- Light gray in color with gloss finish
- Available with clear or opaque door
- Extra interior mounting bosses on rear wall provide multiple mounting options for DIN rail, back panels, or other components. Tightening torque - 10 to 15 lb-in
- Includes mounting flanges with screws
- Features Integra's unique T-Rail mounting system (brackets sold separately) for dead front panels, swing-out panels, layering subpanels, and/or infinitely variable subpanel height

Listings

- UL/cUL 50/50E listed UL 1, 2, 3, 3R, 3S, 4, 4X, 6, 6P, 12, and 13
- UL File E207562
- Flammability Rating: UL94-5VA
- Outdoor UV Exposure Rating: UL-F1



Note: 6P rating requires the use of 4 screws in cover corners.

Approvals

- To obtain the most current agency approval information, see the Agency Approval Checklist section on the specific part number's web page.

Shipping Schedule

Same day 1 - 5 days 1 - 7 days 1 - 15 days 1 - 20 days

Color indicates shipping lead time in business days.

Polycarbonate Enclosures – Premium Series – Wall-Mount, Hinged Screw Cover

Opaque Cover	Price	Clear Cover	Price	Enclosure Overall Size HxWxD	Drawing Link
H6064HF-6P-P10	\$88.00	H6064HCF-6P-P10	\$100.00	6.54 x 6.54 x 4.82 [166 x 166 x 122]	PDF
H8064HF-6P-P10	\$97.00	H8064HCF-6P-P10	\$111.00	8.44 x 6.44 x 4.71 [214 x 164 x 120]	PDF
H8084HF-6P-P10	\$110.00	H8084HCF-6P-P10	\$124.00	8.44 x 8.44 x 4.82 [214 x 214 x 122]	PDF
H10084HF-6P-P10	\$123.00	H10084HCF-6P-P10	\$138.00	10.54 x 8.54 x 4.66 [268 x 217 x 118]	PDF
H10086HF-6P-P10	\$129.00	H10086HCF-6P-P10	\$143.00	10.54 x 8.54 x 6.66 [268 x 217 x 169]	PDF
H12104HF-6P-P10	\$140.00	H12104HCF-6P-P10	\$156.00	12.54 x 10.54 x 4.71 [319 x 268 x 120]	PDF
H12106HF-6P-P10	\$150.00	H12106HCF-6P-P10	\$173.00	12.54 x 10.54 x 6.71 [319 x 268 x 170]	PDF
H141206HF-6P-P10	\$179.00	H141206HCF-6P-P10	\$193.00	14.58 x 12.58 x 7.04 [370 x 320 x 179]	PDF
H161407HF-6P-P10	\$219.00	H161407HCF-6P-P10	\$250.00	16.70 x 14.70 x 8.04 [424 x 373 x 204]	PDF
H181610HF-6P-P10	\$253.00	H181610HCF-6P-P10	\$279.00	18.91 x 16.91 x 11.08 [480 x 430 x 281]	PDF

Notes: Subpanels must be ordered separately.
Dimensions in inches [millimeters].

Polycarbonate Enclosures – Premium Series

Wall-Mount, Single-Door with Non-Metallic Latch



Construction

- Polycarbonate for 900 in-lb, high impact resistance
- Polycarbonate is stable and holds its tensile strength better than other non-metallic materials over a temperature range from -40°F to 265°F (-40° to 129°C)
- Standard hinges for easy door removal or replacement while permitting a full 225° door swing
- Padlockable, quick-release latch made from glass-filled nylon
- Light gray in color with gloss finish
- Available with clear or opaque door
- Extra interior mounting bosses on rear wall provide multiple mounting options for DINrail, back panels, or other components. Tightening torque - 10 to 15 lb-in
- Includes mounting flanges with screws
- Features Integra's unique T-Rail mounting system (brackets sold separately) for dead-front panels, swing-out panels, layering subpanels, and/or infinitely variable subpanel height

Listings

- UL/cUL 50/50E listed UL 1, 2, 3, 3R, 3S, 4, 4X, 12, and 13
- UL File E207562
- Flammability Rating: UL94-5VA
- Outdoor UV Exposure Rating: UL-F1
- Non-Metallic Latch Flammability Rating: UL94-HB



Approvals

- To obtain the most current agency approval information, see the Agency Approval Checklist section on the specific part number's web page.

Shipping Schedule

Same day 1 - 5 days 1 - 7 days 1 - 15 days 1 - 20 days

Color indicates shipping lead time in business days.

Polycarbonate Enclosures – Premium Series – Wall-Mount, Single-Door with Non-Metallic Latch

Opaque Door	Price	Clear Door	Price	No. Latches	Enclosure Overall Size HxWxD	Drawing Link
H6064HFNL-P10	\$100.00	H6064HCFNL-P10	\$110.00	1	6.54 x 6.54 x 4.82 [166 x 166 x 122]	PDF
H8064HFNL-P10	\$106.00	H8064HCFNL-P10	\$119.00	1	8.44 x 6.44 x 4.71 [214 x 164 x 120]	PDF
H8084HFNL-P10	\$118.00	H8084HCFNL-P10	\$129.00	1	8.44 x 8.44 x 4.82 [214 x 214 x 122]	PDF
H10084HFNL-P10	\$128.00	H10084HCFNL-P10	\$143.00	1	10.54 x 8.54 x 4.66 [268 x 217 x 118]	PDF
H10086HFNL-P10	\$136.00	H10086HCFNL-P10	\$150.00	1	10.54 x 8.54 x 6.66 [268 x 217 x 169]	PDF
H12104HFNL-P10	\$156.00	H12104HCFNL-P10	\$173.00	2	12.54 x 10.54 x 4.71 [319 x 268 x 120]	PDF
H12106HFNL-P10	\$169.00	H12106HCFNL-P10	\$188.00	2	12.54 x 10.54 x 6.71 [319 x 268 x 170]	PDF
H141206HFNL-P10	\$204.00	H141206HCFNL-P10	\$223.00	2	14.58 x 12.58 x 7.04 [370 x 320 x 179]	PDF
H161407HFNL-P10	\$240.00	H161407HCFNL-P10	\$271.00	2	16.70 x 14.70 x 8.04 [424 x 373 x 204]	PDF
H181610HFNL-P10	\$282.00	H181610HCFNL-P10	\$311.00	2	18.91 x 16.91 x 11.08 [480 x 430 x 281]	PDF

Notes: Subpanels must be ordered separately.
Dimensions in inches [millimeters].

Polycarbonate Enclosures – Premium Series



Dimensions

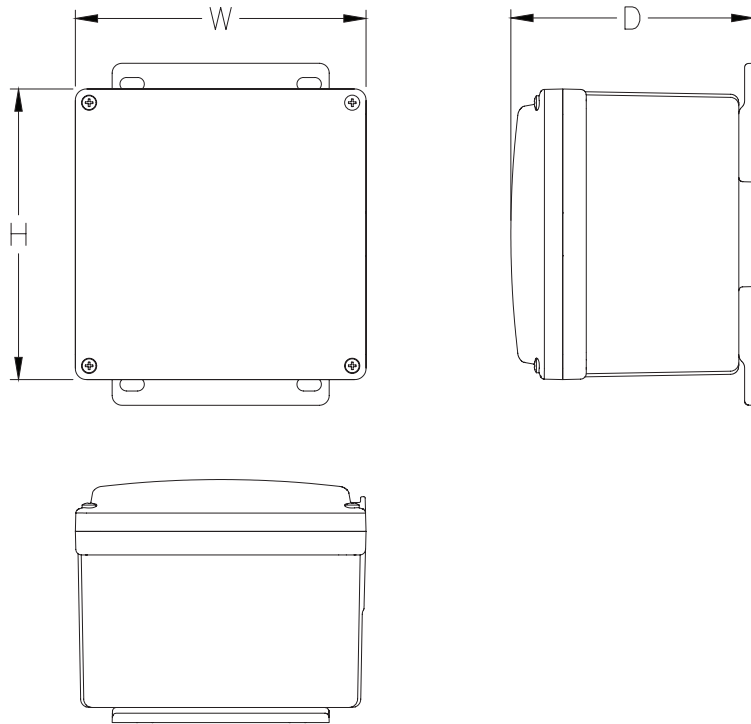

Polycarbonate Enclosures – Premium Series

Subpanels and Swing-Out Panels



Construction

- Subpanels available in aluminum, PVC, and steel with white powder coat finish
- Swing-out panels available in aluminum
- Mounting hardware included
- Use the Adjustable Depth Subpanel Mounting Kit with any subpanel to create a dead-front panel with adjustable depth
- Mounting screw torque - 10 to 15 lb-in
- Aluminum panels are 0.063in [1.6mm] thick
- Painted steel panels are 0.075in [1.9mm] thick
- PVC panels are 0.187in [4.7mm] thick

Shipping Schedule

Same day 1 - 5 days 1 - 7 days 1 - 15 days 1 - 20 days

Color indicates shipping lead time in business days.

Premium Series – Polycarbonate Enclosures – Subpanels

Aluminum	Price	PVC	Price	Aluminum and PVC Dimensions HxW	Painted Steel	Price	Painted Steel Dimensions HxW	For Use With	Drawing Link
ABP66-P10	\$17.00	PVCBP66-P10	\$22.00	4.88 x 4.88 [124 x 124]	SBP66-P10	\$38.50	4.88 x 4.88 [124 x 124]	H606 enclosures	PDF
ABP86-P10	\$19.75	PVCBP86-P10	\$25.00	6.75 x 4.88 [171 x 124]	SBP86-P10	\$43.00	6.88 x 4.88 [175 x 124]	H806 enclosures	PDF
ABP88-P10	\$22.50	PVCBP88-P10	\$28.50	6.88 x 6.75 [175 x 171]	SBP88-P10	\$44.00	6.88 x 6.88 [175 x 175]	H808 enclosures	PDF
ABP108-P10	\$28.00	PVCBP108-P10	\$35.00	8.75 x 6.88 [222 x 175]	SBP108-P10	\$49.00	8.88 x 6.88 [226 x 175]	H1008 enclosures	PDF
ABP1210-P10	\$32.50	PVCBP1210-P10	\$40.00	10.75 x 8.88 [273 x 226]	SBP1210-P10	\$59.00	10.88 x 8.88 [276 x 226]	H1210 enclosures	PDF
ABP-1412-P10	\$48.50	PVCBP-1412-P10	\$57.00	12.75 x 10.88 [324 x 276]	SBP-1412-P10	\$75.00	12.75 x 10.88 [324 x 276]	H1412 enclosures	PDF
ABP-1614-P10	\$56.00	PVCBP-1614-P10	\$74.00	14.75 x 12.88 [375 x 327]	SBP-1614-P10	\$91.00	14.75 x 12.88 [375 x 327]	H1614 enclosures	PDF
ABP-1816-P10	\$76.00	PVCBP-1816-P10	\$110.00	16.75 x 14.88 [425 x 378]	SBP-1816-P10	\$106.00	16.75 x 14.88 [425 x 378]	H1816 enclosures	PDF

Note: Dimensions in inches [millimeters].

Premium Series – Polycarbonate Enclosures – Swing-Out Panels

Aluminum	Price	Dimension HxW	For Use With	Drawing Link
ABP-66USOPK-P10	\$49.00	4.92 x 4.92 [125 x 125]	H606 enclosures	PDF
ABP-86USOPK-P10	\$52.00	6.75 x 4.87 [171 x 124]	H806 enclosures	PDF
ABP-88USOPK-P10	\$55.00	6.75 x 6.87 [171 x 174]	H808 enclosures	PDF
ABP-108USOPK-P10	\$60.00	8.75 x 6.88 [222 x 175]	H1008 and P1008 enclosures	PDF
ABP-1210USOPK-P10	\$65.00	10.88 x 8.88 [276 x 226]	H1210 enclosures	PDF
ABP-1412USOPK-P10	\$80.00	12.75 x 10.88 [324 x 276]	H1412 enclosures	PDF
ABP-1614USOPK-P10	\$88.00	14.75 x 12.88 [375 x 327]	H1614 enclosures	PDF
ABP-1816USOPK-P10	\$108.00	16.75 x 14.88 [425 x 378]	H1816 enclosures	PDF

Note: Dimensions in inches [millimeters].



Premium Series – Polycarbonate Enclosures – Adjustable Depth Subpanel Mounting Kit

Part Number	Price	Includes
BPAKG-P10	\$24.50	4 brackets with set screws
UBPAKG-P10	\$28.00	4 brackets with thumb screws

Note: Also fits P1008 Impact series enclosures.



UBPAKG-P10



BPAKG-P10

Polycarbonate Enclosures – Premium Series



Dimensions

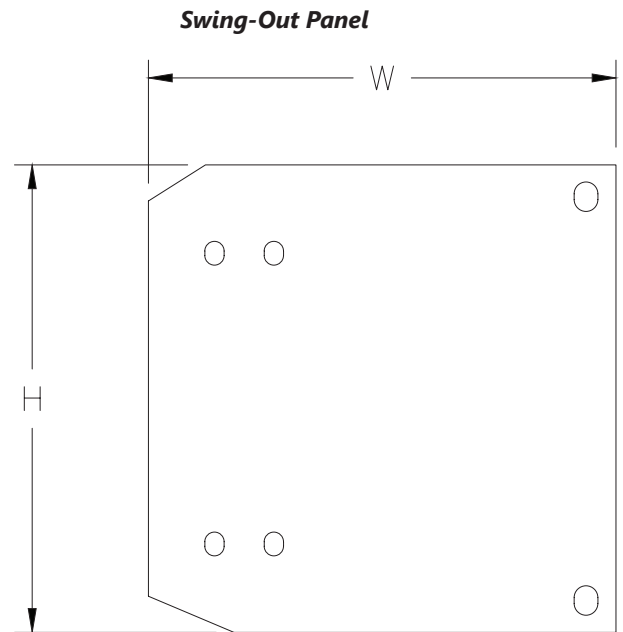
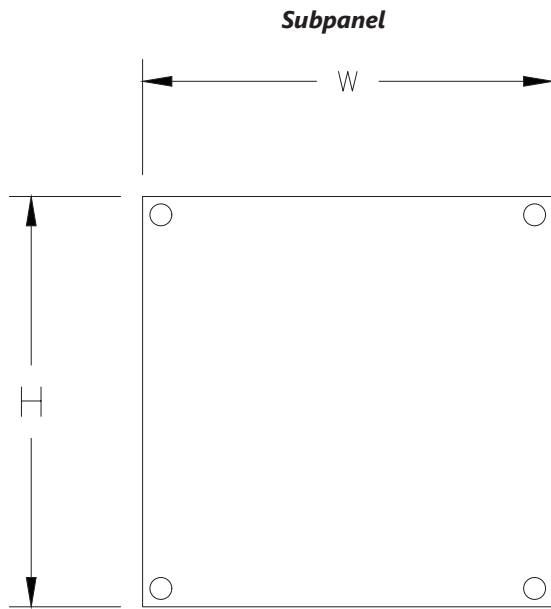

Polycarbonate Enclosures – Genesis Series

Wall-Mount, Single-Door with Non-Metallic Latch



Construction

- Polycarbonate for 900 in-lb, high impact resistance
- Polycarbonate is stable and holds its tensile strength better than other non-metallic materials over a temperature range from -40°F to 265°F (-40° to 129°C)
- Piano- hinged door for easy removal or replacement while permitting a full 225° door swing
- Quick-release latches made from glass-filled nylon
- Integrated padlock hasp
- Light gray in color with gloss finish
- Available with clear or opaque door
- Extra interior mounting bosses on rear wall provide multiple mounting options for DINrail, back panels, or other components.
- Tightening torque - 10 to 15 lb-in
- Features the Multi-Max rail system, which provides unlimited mounting potential for your application
- Rails mount vertically by attaching to the rear wall of the enclosure and to the Multi-Max frame
 - Can be used all around the interior of the enclosure to create three-dimensional use of all the space inside the enclosure
 - Multi-Max rails and Multi-Max frame are sold separately
- G242410 enclosure has removable mounting flanges for accessibility screwed onto the recessed back side
 - Mounting flanges and screws are included
- G201608 enclosures have integrated mounting flanges

Listings

- UL/cUL 50 listed UL 1, 2, 3, 3R, 3S, 4, 4X, 6, 6P, 12, and 13
- UL File E207562
- Flammability Rating: UL94-5VA
- Outdoor UV Exposure Rating: UL-F1
- Non-Metallic Latch Flammability Rating: UL94-HB



Approvals

- To obtain the most current agency approval information, see the Agency Approval Checklist section on the specific part number's web page.

Shipping Schedule

Same day 1 - 5 days 1 - 7 days 1 - 15 days 1 - 20 days

Color indicates shipping lead time in business days.

Genesis Series – Polycarbonate Enclosures – Wall-Mount Single-Door with Non-Metallic Locking Latch

Opaque Door	Price	Clear Door	Price	No. Latches	Enclosure Overall Size HxWxD	Drawing Link
G201608E-P10	\$515.00	G201608CE-P10	\$567.00	2	23.54 x 19.36 x 9.44 [598 x 492 x 240]	PDF
G242410E-P10	\$711.00	G242410CE-P10	\$820.00	4	26.32 x 26.14 x 11.50 [669 x 664 x 292]	PDF

Notes: Subpanels must be ordered separately.
Dimensions in inches [millimeters].

Polycarbonate Enclosures – Genesis Series



Dimensions

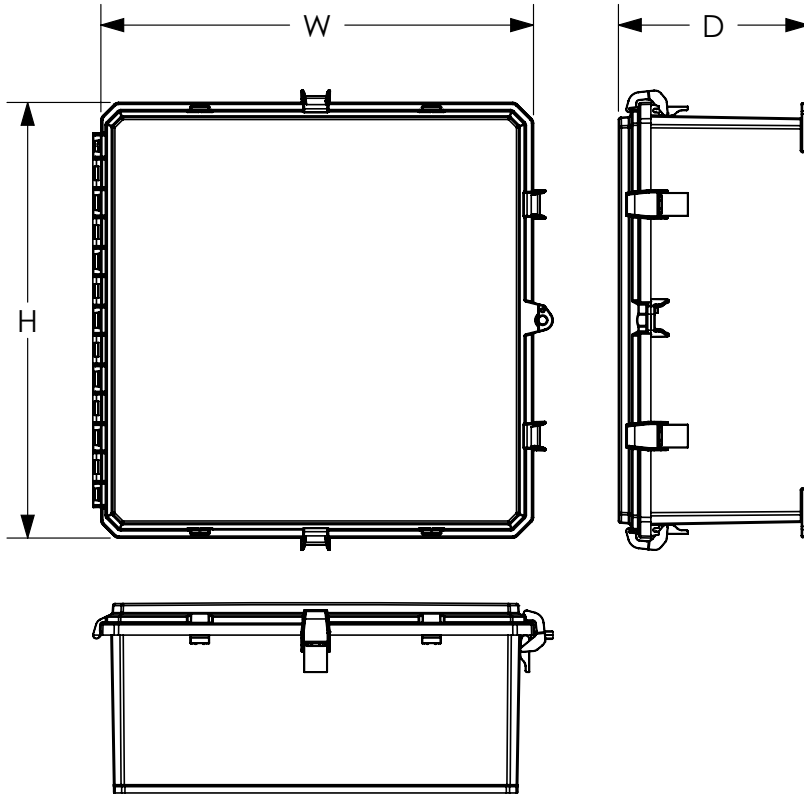

Polycarbonate Enclosures – Genesis Series

Subpanels, Swing-Out Panels, and Side-Mount Panels



Construction

- Subpanels available in aluminum, PVC, and steel with white powder coat finish
- Swing-out panels available in aluminum and painted steel
- Swing-out panels require the appropriate Multi-Max Rails and Multi-Max Frame Stiffener (sold separately)
- Side-Mount panels available in aluminum and painted steel
- Side-Mount panels require the appropriate Multi-Max Rails and Multi-Max Frame Stiffener (sold separately)
- Mounting hardware included
- To make any back subpanel adjustable depth, use the Multi-Max Rails, Multi-Max Frame Stiffener, and Panel Pad kit (sold separately)
- Mounting screw torque - 10 to 15 lb-in
- Aluminum panels are 0.063in [1.6mm] thick
- Painted steel panels are 0.075in [1.9mm] thick
- PVC panels are 0.187in [4.7mm] thick

Shipping Schedule

Same day 1 - 5 days 1 - 7 days 1 - 15 days 1 - 20 days

Color indicates shipping lead time in business days.

Genesis Series – Polycarbonate Enclosures – Subpanels

Aluminum	Price	PVC	Price	Painted Steel	Price	Dimensions HxW	For Use With	Drawing Link
ABP-2016-P10	\$95.00	PVCBP-2016-P10	\$147.00	SBP-2016-P10	\$269.00	18.88 x 14.88 [480 x 378]	G2016 enclosures	PDF
ABP-2016-XXL-P10	\$147.00	—	—	SBP-2016-XXL-P10	\$328.00	21.09 x 17.09 [536 x 434]	G2016 enclosures	PDF
ABP-2424-P10	\$161.00	PVCBP-2424-P10	\$197.00	SBP-2424-P10	\$345.00	21.00 x 21.00 [533 x 533]	G2424 enclosures	PDF
ABP-2424-XXL-P10	\$241.00	—	—	SBP-2424-XXL-P10	\$452.00	23.25 x 23.25 [591 x 591]	G2424 enclosures	PDF

Notes: Dimensions in inches [millimeters].
XXL subpanels cannot be used with Multi-Max Rails.

Genesis Series – Polycarbonate Enclosures – Swing-Out Panels

Aluminum	Price	Painted Steel	Price	Dimension HxW	For Use With	Drawing Link
ABP-2016GSOPK-P10	\$216.00	SBP-2016GSOPK-P10	\$334.00	18.88 x 14.88 [480 x 378]	G2016 enclosures	PDF
ABP-2424GSOPK-P10	\$283.00	SBP-2424GSOPK-P10	\$361.00	21.00 x 21.00 [533 x 533]	G2424 enclosures	PDF

Notes: Dimensions in inches [millimeters].
2016GSOPK Swing-Panels require KIT-GMMR8-P10 and GSR2016-P10.
2424GSOPK Swing-Panels require KIT-GMMR10-P10 and GSR2424-P10.



Genesis Series Polycarbonate Enclosures - Side-Mount Subpanels

Aluminum	Price	Painted Steel	Price	Dimension HxW	For Use With	Drawing Link
ASP-2016-P10	\$65.00	SSP-2016-P10	\$115.00	15.00 x 6.25 [381 x 159]	G2016 enclosures	PDF
ASP-2424-P10	\$107.00	SSP-2424-P10	\$180.00	21.75 x 7.88 [552 x 200]	G2424 enclosures	PDF

Notes: Dimensions in inches [millimeters].
2016 Side-Mount Subpanels require KIT-GMMR8-P10 and GSR2016-P10.
2424 Side-Mount Subpanels require KIT-GMMR10-P10 and GSR2424-P10.

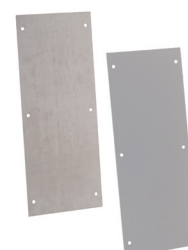

Polycarbonate Enclosures – Genesis Series



Dimensions

Subpanel and Swing-Out Panel

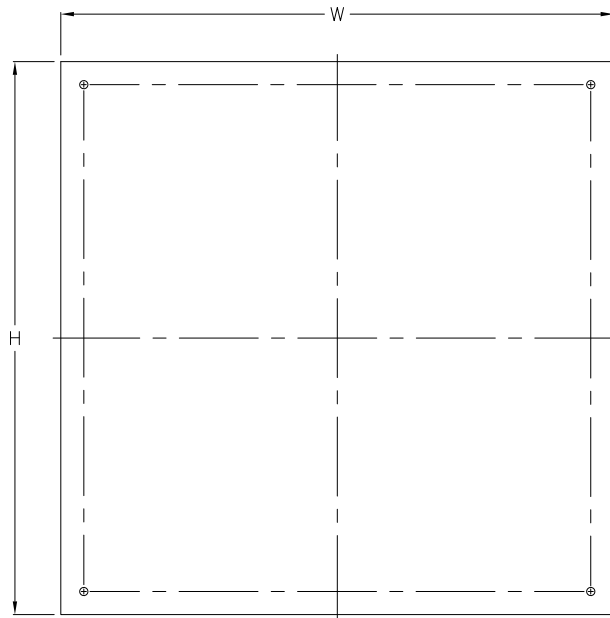

Side-mount Panel

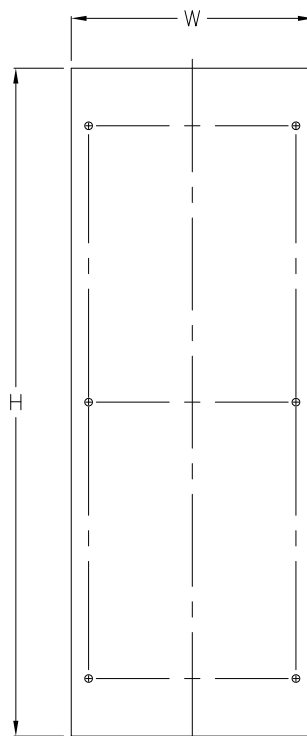

Polycarbonate Enclosures – Accessories for Genesis Series Enclosures



Shipping Schedule

Same day 1 - 5 days 1 - 7 days 1 - 15 days 1 - 20 days

Color indicates shipping lead time in business days.

Mounting Flange Kit

Part Number	Price	Description	For use with
<u>GMLFK24-SET-P10</u>	\$74.00	Includes (2) mounting flanges with mounting screws	24 x 24 x 10in Genesis series enclosures

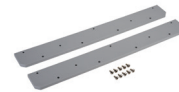

Multi-Max Frame Stiffener Ring

Part Number	Price	Description	For use with
<u>GSR2016-P10</u>	\$52.00	frame stiffener ring	20 x 16 x 8in Genesis series enclosures
<u>GSR2424-P10</u>	\$88.00	frame stiffener ring	24 x 24 x 10in Genesis series enclosures



Multi-Max Internal Mounting Rail Kit

Part Number	Price	Description	For use with
<u>KIT-GMMR8-P10</u>	\$70.00	Includes (4) mounting rails with mounting screws.	20 x 16 x 8in Genesis series enclosures
<u>KIT-GMMR10-P10</u>	\$79.00	Includes (4) mounting rails with mounting screws.	24 x 24 x 10in Genesis series enclosures



Rail Screw Kit

Part Number	Price	Description	For use with
<u>GMMR-SCREWS-P10</u>	\$21.00	Includes (4) #10-32 x 0.38in stainless steel flat head screws and (8) #10-32 x 0.50in stainless steel pan head thread-cutting screws.	Multi-Max series internal mounting rails



Panel Pad Kit

Part Number	Price	Description	For use with
<u>KIT-GPP-2016-P10</u>	\$61.00	(4) panel pads with mounting screws to affix to vertical Multi-Max rails for mounting panels at varying heights	20 x 16 x 8in Genesis series enclosures
<u>KIT-GPP-P10</u>	\$61.00	(4) panel pads with mounting screws to affix to vertical Multi-Max rails for mounting panels at varying heights	24 x 24 x 10in Genesis series enclosures



Polycarbonate Enclosures

Pole-Mounting Kits



Construction

- All kits include galvanized steel strut rails and plated steel fasteners
- Kits for 9.5 to 12 in [241 to 305 mm] diameter poles include galvanized steel band clamps and brackets. All other kits include galvanized steel pipe clamps

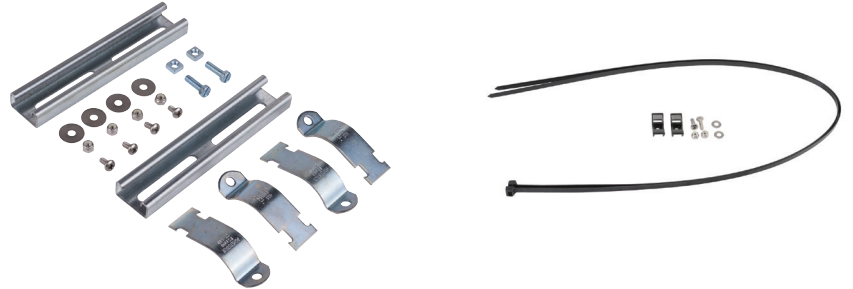

Shipping Schedule

Same day 1 - 5 days 1 - 7 days 1 - 15 days 1 - 20 days

Color indicates shipping lead time in business days.

Pole Mounting Kits for Integra Premium Series Enclosures

Part Number	Price	Pole Diameter	Kit Includes	For Use With Enclosure Width
PMKG-26-P10	\$56.00	2 in [51 mm]	Galvanized steel strut rails, pipe clamps, and brackets; plated steel fasteners	6 in [152 mm]
PMKG-36-P10	\$68.00	3 in [76 mm]	Galvanized steel strut rails, pipe clamps, and brackets; plated steel fasteners	6 in [152 mm]
PMKG-46-P10	\$70.00	4 in [102 mm]	Galvanized steel strut rails, pipe clamps, and brackets; plated steel fasteners	6 in [152 mm]
PMKG-126-P10	\$87.00	9.5 to 12 in [241 to 305 mm]	Galvanized steel strut rails, band clamps, and brackets; plated steel fasteners	6 in [152 mm]
PMKG-28-P10	\$61.00	2 in [51 mm]	Galvanized steel strut rails, pipe clamps, and brackets; plated steel fasteners	8 in [203 mm]
PMKG-38-P10	\$68.00	3 in [76 mm]	Galvanized steel strut rails, pipe clamps, and brackets; plated steel fasteners	8 in [203 mm]
PMKG-48-P10	\$70.00	4 in [102 mm]	Galvanized steel strut rails, pipe clamps, and brackets; plated steel fasteners	8 in [203 mm]
PMKG-128-P10	\$88.00	9.5 to 12 in [241 to 305 mm]	Galvanized steel strut rails, band clamps, and brackets; plated steel fasteners	8 in [203 mm]
PMKG-210-P10	\$61.00	2 in [51 mm]	Galvanized steel strut rails, pipe clamps, and brackets; plated steel fasteners	10 in [254 mm]
PMKG-310-P10	\$68.00	3 in [76 mm]	Galvanized steel strut rails, pipe clamps, and brackets; plated steel fasteners	10 in [254 mm]
PMKG-410-P10	\$72.00	4 in [102 mm]	Galvanized steel strut rails, pipe clamps, and brackets; plated steel fasteners	10 in [254 mm]
PMKG-1210-P10	\$91.00	9.5 to 12 in [241 to 305 mm]	Galvanized steel strut rails, band clamps, and brackets; plated steel fasteners	10 in [254 mm]
PMKG-212-P10	\$62.00	2 in [51 mm]	Galvanized steel strut rails, pipe clamps, and brackets; plated steel fasteners	12 in [305 mm]
PMKG-312-P10	\$70.00	3 in [76 mm]	Galvanized steel strut rails, pipe clamps, and brackets; plated steel fasteners	12 in [305 mm]
PMKG-412-P10	\$73.00	4 in [102 mm]	Galvanized steel strut rails, pipe clamps, and brackets; plated steel fasteners	12 in [305 mm]
PMKG-1212-P10	\$94.00	9.5 to 12 in [241 to 305 mm]	Galvanized steel strut rails, band clamps, and brackets; plated steel fasteners	12 in [305 mm]
PMKG-214-P10	\$65.00	2 in [51 mm]	Galvanized steel strut rails, pipe clamps, and brackets; plated steel fasteners	14 in [357 mm]
PMKG-314-P10	\$73.00	3 in [76 mm]	Galvanized steel strut rails, pipe clamps, and brackets; plated steel fasteners	14 in [357 mm]
PMKG-414-P10	\$79.00	4 in [102 mm]	Galvanized steel strut rails, pipe clamps, and brackets; plated steel fasteners	14 in [357 mm]
PMKG-1214-P10	\$95.00	9.5 to 12 in [241 to 305 mm]	Galvanized steel strut rails, band clamps, and brackets; plated steel fasteners	14 in [357 mm]
PMKG-216-P10	\$69.00	2 in [51 mm]	Galvanized steel strut rails, pipe clamps, and brackets; plated steel fasteners	16 in [406 mm]
PMKG-316-P10	\$77.00	3 in [76 mm]	Galvanized steel strut rails, pipe clamps, and brackets; plated steel fasteners	16 in [406 mm]
PMKG-416-P10	\$86.00	4 in [102 mm]	Galvanized steel strut rails, pipe clamps, and brackets; plated steel fasteners	16 in [406 mm]
PMKG-1216-P10	\$97.00	9.5 to 12 in [241 to 305 mm]	Galvanized steel strut rails, band clamps, and brackets; plated steel fasteners	16 in [406 mm]
PMKG-12-IMP-P10*	\$37.50	2 in [51 mm] to 12 in [305 mm]	Plastic tie wrap and mount adapter; plated steel fasteners	4 in [102 mm]
PMKG-26-IMP-P10	\$56.00	2 in [51 mm]	Galvanized steel strut rails, pipe clamps, and brackets; plated steel fasteners	6 in [152 mm]
PMKG-36-IMP-P10	\$68.00	3 in [76 mm]	Galvanized steel strut rails, pipe clamps, and brackets; plated steel fasteners	6 in [152 mm]
PMKG-46-IMP-P10	\$70.00	4 in [102 mm]	Galvanized steel strut rails, pipe clamps, and brackets; plated steel fasteners	6 in [152 mm]
PMKG-126-IMP-P10	\$87.00	9.5 to 12 in [241 to 305 mm]	Galvanized steel strut rails, band clamps, and brackets; plated steel fasteners	6 in [152 mm]
PMKG-28-IMP-P10	\$61.00	2 in [51 mm]	Galvanized steel strut rails, pipe clamps, and brackets; plated steel fasteners	8 in [203 mm]
PMKG-38-IMP-P10	\$68.00	3 in [76 mm]	Galvanized steel strut rails, pipe clamps, and brackets; plated steel fasteners	8 in [203 mm]
PMKG-48-IMP-P10	\$70.00	4 in [102 mm]	Galvanized steel strut rails, pipe clamps, and brackets; plated steel fasteners	8 in [203 mm]
PMKG-128-IMP-P10	\$88.00	9.5 to 12 in [241 to 305 mm]	Galvanized steel strut rails, band clamps, and brackets; plated steel fasteners	8 in [203 mm]

Notes: Dimensions in inches [millimeters].

All kits include galvanized steel strut rails and plated steel fasteners, except PMKG-12-IMP-P10, which does not have strut rails.

Polycarbonate Enclosures

Pole-Mounting Kits



Shipping Schedule

Same day 1 - 5 days 1 - 7 days 1 - 15 days 1 - 20 days

Color indicates shipping lead time in business days.

Pole Mounting Kits for Integra Genesis Series Enclosures

Part Number	Price	Pole Diameter	Kit Includes	For Use With Enclosure Width
<u>PMKG-216-GEN-P10</u>	\$70.00	2 in [51 mm]	Galvanized steel strut rails, band clamps, and brackets; plated steel fasteners	16 in [406 mm]
<u>PMKG-316-GEN-P10</u>	\$78.00	3 in [76 mm]	Galvanized steel strut rails, pipe clamps, and brackets; plated steel fasteners	16 in [406 mm]
<u>PMKG-416-GEN-P10</u>	\$87.00	4 in [102 mm]	Galvanized steel strut rails, pipe clamps, and brackets; plated steel fasteners	16 in [406 mm]
<u>PMKG-1216-GEN-P10</u>	\$99.00	9.5 to 12 in [241 to 305 mm]	Galvanized steel strut rails, pipe clamps, and brackets; plated steel fasteners	16 in [406 mm]
<u>PMKG-224-P10</u>	\$64.00	2 in [51 mm]	Galvanized steel strut rails, pipe clamps, and brackets; plated steel fasteners	24 in [102 mm]
<u>PMKG-324-P10</u>	\$70.00	3 in [76 mm]	Galvanized steel strut rails, pipe clamps, and brackets; plated steel fasteners	24 in [102 mm]
<u>PMKG-424-P10</u>	\$77.00	4 in [102 mm]	Galvanized steel strut rails, pipe clamps, and brackets; plated steel fasteners	24 in [102 mm]
<u>PMKG-1224-P10</u>	\$94.00	9.5 to 12 in [241 to 305 mm]	Galvanized steel strut rails, pipe clamps, and brackets; plated steel fasteners	24 in [102 mm]

Polycarbonate Enclosures – Accessories



Shipping Schedule

Same day 1 - 5 days 1 - 7 days 1 - 15 days 1 - 20 days

Color indicates shipping lead time in business days.

Slotted DIN Rail 35mm x 7mm Plated Steel

Part Number	Price	Length	For Use With
DIN4-IMP-P10	\$18.00	3.82 [97]	4in wide Impact series enclosures
DIN6-IMP-P10	\$18.00	4.88 [124]	6in wide Impact series enclosures
DIN8-IMP-P10	\$24.50	6.75 [171]	8in wide Impact series enclosures
DIN6-P10	\$18.00	4.88 [124]	6in wide Premium series enclosures
DIN8-P10	\$24.50	6.75 [171]	8in wide Premium series enclosures
DIN10-P10	\$25.50	8.88 [225]	10in wide Premium series enclosures
DIN12-P10	\$33.00	10.75 [273]	12in wide Premium series enclosures
DIN14-P10	\$36.00	12.75 [324]	14in wide Premium series enclosures
DIN16-P10	\$39.00	15.00 [381]	16in wide Premium series enclosures
DIN16-GEN-P10	\$39.00	16.8 [427]	16in wide Genesis series enclosures
DIN24-P10	\$62.00	23.63 [600]	24in wide Genesis series enclosures

Notes: Each item includes (2) DIN rails and mounting hardware.
Dimensions in inches [millimeters].

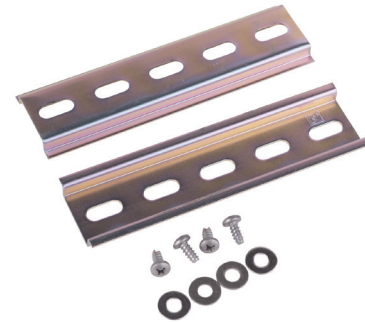

Mounting Feet Kits

Part Number	Price	Material	For Use With
MFKG-P10	\$16.25	polycarbonate	Premium series enclosures
MFKSS-P10	\$45.00	304 stainless steel	Premium series enclosures

Note: Each kit includes (4) mounting feet and mounting hardware.



Screw Packs (10 Pcs)

Part Number	Price	Screw Type	Size	Screw Head	For Use With
SP-8-P10	\$12.25	25-thread cutting	#8-32 x 3/8 in	Phillips pan head	4in and 6in wide Impact series enclosures
SP-10I-P10	\$14.00	25-thread cutting	#10-32 x 3/8 in	Phillips pan head	8in wide Impact series and all Premium series enclosures
GMFLK-SCREWS-P10	\$25.50	Machine-screw	1/4-20 UNC x 1/2 in	Phillips pan head	Genesis series mounting flanges
GSP10-P10	\$14.50	25-thread cutting	#10-32 x 1/2 in	Phillips pan head	Genesis series polycarbonate enclosures



SP-8-P604



GMFLK-SCREWS-P10

Polycarbonate Enclosures – Accessories



Shipping Schedule				
Same day	1 - 5 days	1 - 7 days	1 - 15 days	1 - 20 days
Color indicates shipping lead time in business days.				

Outdoor Labyrinth Vent				
Part Number	Price	Material	Dimension HxWxD	For Use With
<u>VENT-2-P10</u>	\$15.75	polypropylene	2.72 x 2.03 x 0.88 [69 x 52 x 22]	Impact, Premium and Genesis series enclosures
Notes: Installation of vent de-rates enclosure to NEMA 3R. Dimensions in inches [millimeters].				



Replacement Quick-Release Latches			
Part Number	Price	Latch Material	For Use With
<u>SLL-KIT-P10</u>	\$25.50	304 stainless steel	Premium and Genesis series enclosures
<u>KIT-GPCL-2PK-P10</u>	\$25.00	glass-filled nylon	Genesis series enclosures (set of 2)



SLL-KIT-P10



KIT-GPCL-2PK-P10