

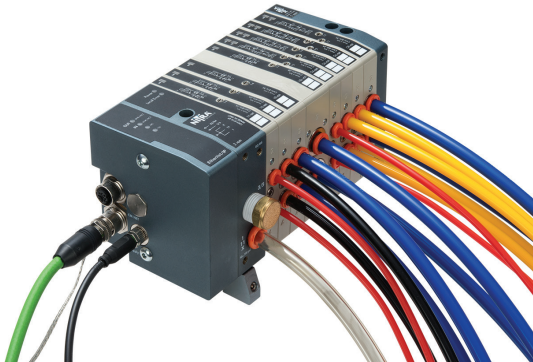

# Compact Modular Valves

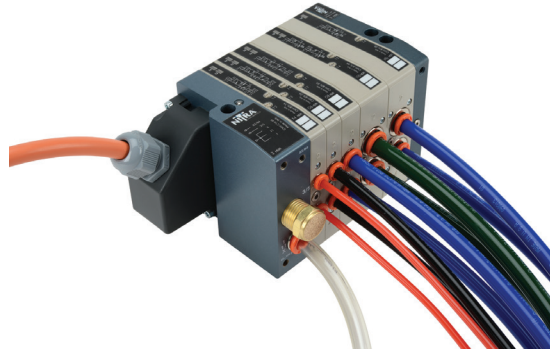

Unit assembly shows Compact Modular Valve bank with EIP Module attached.



Unit assembly shows Compact Modular Valve bank with D-Sub Module attached.

NITRA compact modular valves are the ideal solution for those requiring the unbeatable performance, flexibility and modularity of multiple valves combined with sturdy mechanics and a high degree of protection. Each valve is enclosed in a reinforced technopolymer (Celcon®) protective shell that acts as a shock-absorber and prevents the infiltration of dirt. The smooth, rounded design makes the system ideal for applications requiring frequent washing. All the pneumatic connections are on one side, with built-in push-to-connect fittings. The systems offer a variety of flexibility from one to 16 solenoids. Valves can be mixed to use tubing of different sizes and can be individually replaced. The electrical signals are relayed from one valve to the next by gold-plated contacts so the electrical connections are entirely automatic. Both EtherNet/IP or 25-pin D-Sub connector electrical connections are available (Ethernet models require a separate power cable and include a ground strap). Inlet/exhaust end plates and intermediate modules provide flexibility to operate valve banks at vacuum or dual pressures.

## Building the Valve Bank:

### Step 1. Select the control interface: EtherNet/IP or D-Sub connector.

### Step 2. Determine operating pressure and volume.

- Single input/pilot: 45-100 psi, Cv = 12.4
- Duel inlet: vacuum-145 psi, Cv = 12.4 or 16.6; Pilot: 45-100 psi
- Right end dual: vacuum-145 psi, Cv = 16.6

### Step 3. Choose Valves:

- 3-way → (2) Separate valves per module
- 5-way → 2-position or 3-position
- NOTE: Maximum (16) solenoids (not valves) per bank

### Step 4. (Optional) Choose intermediate module

- Through - Adds an inlet and exhaust, others pass thru
- Blind - Blocks inlets from left, adds (2) inlets that feed to the right, and splits a bank into (2) smaller banks.
- Exhaust - Adds an exhaust port, others pass thru



Click on the thumbnail or go to <https://www.automationdirect.com/VID-PN-0040> for a short video on Selecting CMV Valve Components



# Compact Modular Valves

## Compact Modular Valves - End Plates

One left and one right end plate is required per manifold. For continuous flow that will exceed the Cv of the end plates, consider adding an intermediate plate.

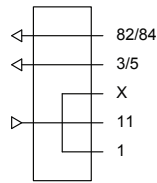

Diagram "A"

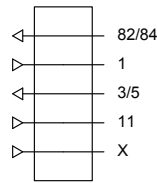

Diagram "B"

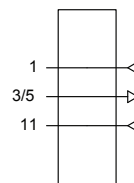









Diagram "C"

Compact Modular Valve - End Plates						
Item	Part No.	Price	Description	Diagram	Operating Pressure	Weight (lbs)
	<a href="#"><u>CMV-E1X-4X</u></a>	\$661.00	NITRA pneumatic EtherNet/IP enabled modular plate, left supply/exhaust end, Cv=12.4, 3/8in push-to-connect tubing inlet(s), 3/8in female NPT exhaust(s), anodized aluminum body.	A	45-100 psi	1.0
	<a href="#"><u>CMV-E2X-4X</u></a>	\$670.00	NITRA pneumatic EtherNet/IP enabled modular plate, left supply/exhaust end, Cv=12.4, (2) 3/8in push-to-connect tubing inlet(s), 3/8in female NPT exhaust(s), 5/32in (4mm) push-to-connect tubing pilot(s), anodized aluminum body.	B	vacuum-145 psi	1.0
	<a href="#"><u>CMV-C1X-4X</u></a>	\$69.00	NITRA pneumatic modular plate, left supply/exhaust end, Cv=12.4, 3/8in push-to-connect tubing inlet(s), 3/8in female NPT exhaust(s), anodized aluminum body.	A	45-100 psi	0.8
	<a href="#"><u>CMV-C2X-4X</u></a>	\$71.00	NITRA pneumatic modular plate, left supply/exhaust end, Cv=12.4, (2) 3/8in push-to-connect tubing inlet(s), 3/8in female NPT exhaust(s), 5/32in (4mm) push-to-connect tubing pilot(s), anodized aluminum body.	B	vacuum-145 psi	0.8
	<a href="#"><u>CMV-C2X-5X</u></a>	\$87.00	NITRA pneumatic modular plate, left supply/exhaust end, Cv=16.6, (2) 1/2in push-to-connect tubing inlet(s), 3/8in female NPT exhaust(s), 5/32in (4mm) push-to-connect tubing pilot(s), anodized aluminum body.	B	vacuum-145 psi	0.8
	<a href="#"><u>CMV-C3X-5X</u></a>	\$69.00	NITRA pneumatic modular plate, right supply/exhaust end, Cv=16.6, (2) 1/2in push-to-connect tubing inlet(s), 3/8in female NPT exhaust(s), anodized aluminum body.	C	vacuum-145 psi	1.4
	<a href="#"><u>CMV-C4X</u></a>	\$26.50	NITRA pneumatic modular plate, right blind end, anodized aluminum body.	N/A	N/A	0.5



# Compact Modular Valves

EtherNet/IP Enabled Modular End Plate Specifications	
<b>Field Buses</b>	EtherNet/IP (IO/Explicit Messaging) - 10/100 Mbit/s Half-duplex - Full-duplex Supports Auto-Negotiation
<b>Factory Settings</b>	Module name CMV series - Address IP 192.168.192.30
<b>Addressing</b>	Software DHCP/BOOTP
<b>Voltage Range</b>	24VDC ±10%
<b>Maximum Number of Solenoids (out)</b>	16
<b>Maximum Number of Valves</b>	16
<b>ICC Bus Supply Current</b>	Nominal lcc 120mA Instantaneous lcc (< 2ms) 450mA
<b>Maximum Absorption of a Valve Distribution (black with 16 mono-stable valves)</b>	Nominal lcc with 120mA OFF valves Nominal lcc with 580mA ON valves
<b>Protections</b>	Module protected against overload and polarity reversal. Outputs protected against overloads and short-circuits.
<b>Connections</b>	Field bus: (2) M12 Female, D-coded, internal switch Supply: M8 4-pin
<b>Data Bit Value</b>	0 = not enabled 1 = enabled
<b>Output Status in the Absence of Communication</b>	Not enabled
<b>Approvals</b>	N/A

Note: For EtherNet/IP communication use a quality Cat5e straight through Ethernet cable such as AutomationDirect CAB-ETH-M0x patch cables. See our Communication Products section online at [www.AutomationDirect.com](http://www.AutomationDirect.com)

## Wiring and Ports

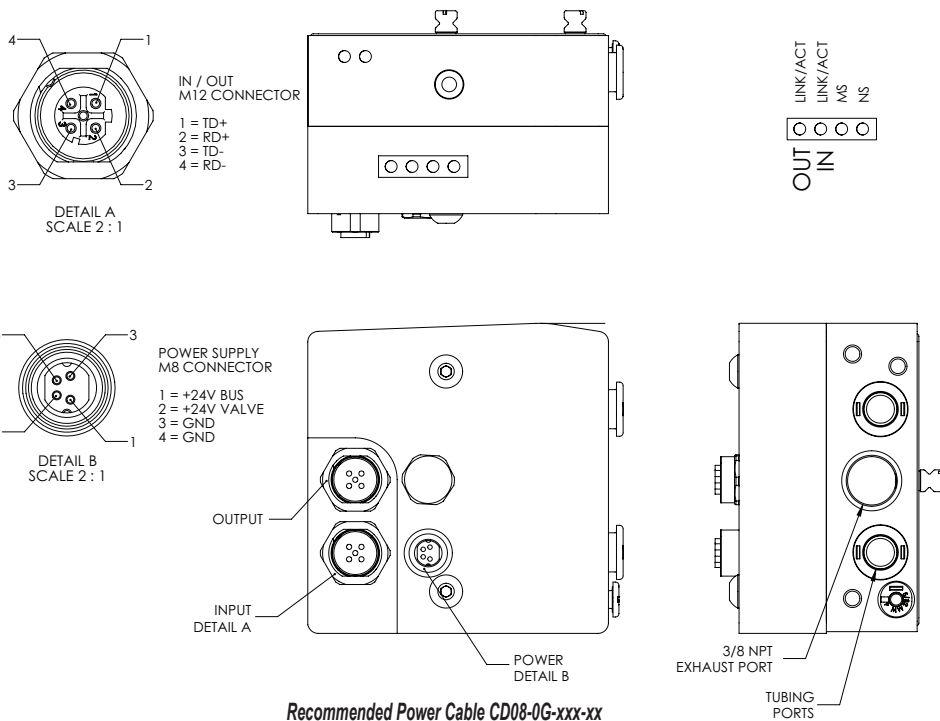



# Compact Modular Valves

## Dimensions

mm [inches]

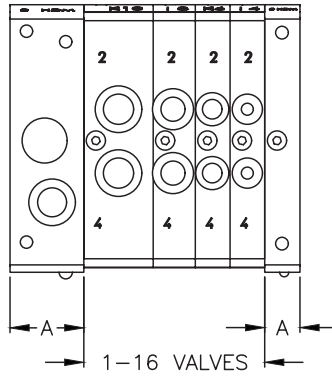
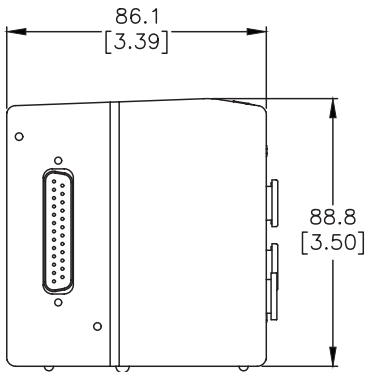

DIM TABLE	
PART NO.	DIM A
CMV-E1X-4X	51.0 [2.01]
CMV-E2X-4X	51.0 [2.01]
CMV-C1X-4X	24.5 [0.96]
CMV-C2X-4X	24.5 [0.96]
CMV-C2X-5X	24.5 [0.96]
CMV-C3X-5X	32.0 [1.25]
CMV-C4X	11.7 [0.46]

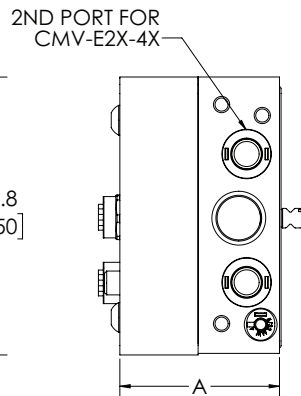
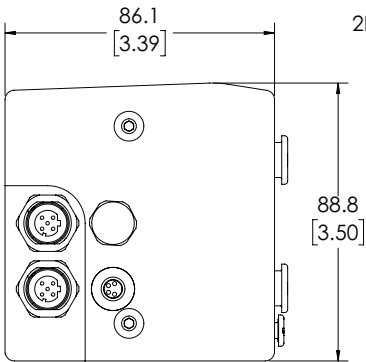

See our website [www.AutomationDirect.com](http://www.AutomationDirect.com) for complete Engineering drawings.



# Compact Modular Valves

## Features:

- Mix valve sizes as needed
- (2) 3/2, 5/2 and 5/3 valves available
- Single solenoid spring return or dual solenoids per valve
- Up to 16 valves (16 solenoids max) per manifold
- Locking manual operator
- IP65
- NBR / Buna-N gaskets and O-ring
- Surge Suppression - TRANSIL™ TVS (Transient Voltage Surge Suppressor)
- 2 year warranty

**Diagram "A"**

**(2) 3-way, 2-pos, Single Solenoids, N.C.**

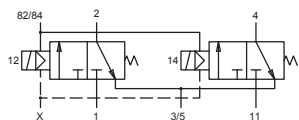

**Diagram "B"**

**(2) 3-way, 2-pos, Single Solenoids, N.O.**

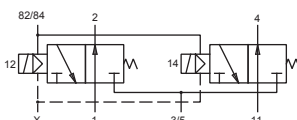

**Diagram "C"**

**(2) 3-way, 2-pos, Single Solenoids, N.C./N.O.**

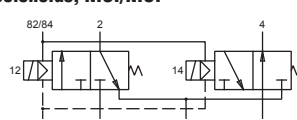

**Diagram "D"**

**5-way, 2-pos, Single Solenoid**

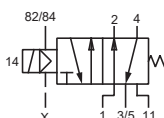

**Diagram "E"**

**5-way, 2-pos, Double Solenoid**

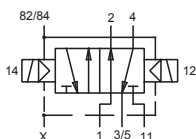

**Diagram "F"**

**5-way, 3-pos, Double Solenoid, Center Closed**

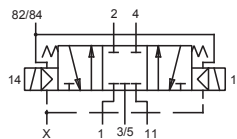

Compact Modular Valve Specifications												
Models	CMV-A1L-1A	CMV-A2L-1A	CMV-A3L-1A	CMV-B1L-1A	CMV-B2L-1A	CMV-B3L-1A	CMV-A1L-2A	CMV-A2L-2A	CMV-A3L-2A	CMV-B1L-2A	CMV-B2L-2A	CMV-B3L-2A
Price	\$123.00	\$123.00	\$123.00	\$85.00	\$107.00	\$120.00	\$125.00	\$125.00	\$125.00	\$88.00	\$123.00	\$123.00
Weight (lbs)	0.3	0.3	0.3	0.3	0.3	0.3	0.3	0.3	0.3	0.3	0.3	0.3
Valve Type	(2) 3-way 2-position N.C. single solenoids	(2) 3-way 2-position N.O. single solenoids	(2) 3-way 2-position N.O./N.C. single solenoids	5-way 2-position single solenoid	5-way 2-position double solenoid	5-way 3-position double solenoid center closed	(2) 3-way 2-position N.C. single solenoids	(2) 3-way 2-position N.O. single solenoids	(2) 3-way 2-position N.O./N.C. single solenoids	5-way 2-position single solenoid	5-way 2-position double solenoid	5-way 3-position double solenoid center closed
Acting	Internally Piloted											
Diagram	A	B	C	D	E	F	A	B	C	D	E	F
Port Size	Out=5/32" or 4mm						Out=1/4"					
Orifice Size*	Cv=0.2						Cv=0.5					Cv=0.3
Fluid	Air (to be filtered by 40µ filter element)											
Nom Pressure	Vacuum - 145 psi (vacuum - 10 bar) valve supply / 45-100 psi (3-7 bar) pilot supply											
Voltage ±10%	24VDC											
Power Consumption	0.9W (per solenoid)											
Max Frequency	8 cycles/sec											
Insulation	F class (155°C / 311°F max coil only)											
Min Response	8ms			20ms			8ms			20ms		
Temperature	-10-60°C [14-140°F]											
Lubrication	Filtered air without lubrication; lubrication, if used, must be continuous											
Protection	IP65 (when using NITRA cables)											
Body	Aluminum with technopolymers (Celcon) shell											
Agency Approvals	None											

\* Cv test conditions of 90psi inlet, ΔP = 14.5 psi, temperature 70°F (21.1°C)



# Compact Modular Valves

Compact Modular Valve Specifications									
Models	<u>CMI-A1L-3A</u>	<u>CMI-A2L-3A</u>	<u>CMI-A3L-3A</u>	<u>CMI-B1L-3A</u>	<u>CMI-B2L-3A</u>	<u>CMI-B3L-3A</u>	<u>CMI-A1L-3B</u>	<u>CMI-A2L-3B</u>	<u>CMI-A3L-3B</u>
Price	\$128.00	\$128.00	\$128.00	\$92.00	\$127.00	\$128.00	\$185.00	\$185.00	\$185.00
Weight (lbs)	0.3	0.3	0.3	0.3	0.3	0.3	0.6	0.3	0.3
Valve Type	(2) 3-way 2-position N.C. single solenoids	(2) 3-way 2-position N.O. single solenoids	(2) 3-way 2-position N.O./N.C. single solenoids	5-way 2-position single solenoid	5-way 2-position double solenoid	5-way 3-position double solenoid center closed	(2) 3-way 2-position N.C. single solenoids	(2) 3-way 2-position N.O. single solenoids	(2) 3-way 2-position N.O./N.C. single solenoids
Acting	Internally Piloted								
Diagram	A	B	C	D	E	F	A	B	C
Port Size	Out=5/16" or 8mm								
Orifice Size*	Cv=0.65			Cv=0.3			Cv=1.0		
Fluid	Air (to be filtered by 40μ filter element)								
Nom Pressure	Vacuum - 145 psi (vacuum - 10 bar) valve supply / 45-100 psi (3-7 bar) pilot supply								
Voltage ±10%	24VDC								
Power Consumption	0.9W (per solenoid)								
Max Frequency	8 cycles/sec								
Insulation	F class (155°C / 311°F max coil only)								
Min Response	8ms			20ms			8ms		
Temperature	-10-60°C [14-140°F]								
Lubrication	Filtered air without lubrication; lubrication, if used, must be continuous								
Protection	IP65 (when using NITRA cables)								
Body	Aluminum with technopolpolymer (Celcon) shell								
Agency Approvals	None								

Compact Modular Valve Specifications									
Models	<u>CMI-B1L-3B</u>	<u>CMI-B2L-3B</u>	<u>CMI-B3L-3B</u>	<u>CMI-A1L-4A</u>	<u>CMI-A2L-4A</u>	<u>CMI-A3L-4A</u>	<u>CMI-B1L-4A</u>	<u>CMI-B2L-4A</u>	<u>CMI-B3L-4A</u>
Price	\$147.00	\$172.00	\$181.00	\$180.00	\$180.00	\$180.00	\$147.00	\$163.00	\$174.00
Weight (lbs)	0.5	0.6	0.6	0.6	0.6	0.6	0.6	0.6	0.6
Valve Type	5-way 2-position single solenoid	5-way 2-position double solenoid	5-way 3-position double solenoid center closed	(2) 3-way 2-position N.C. single solenoids	(2) 3-way 2-position N.O. single solenoids	(2) 3-way 2-position N.O./N.C. single solenoids	5-way 2-position single solenoid	5-way 2-position double solenoid	5-way 3-position double solenoid center closed
Acting	Internally Piloted								
Diagram	D	E	F	A	B	C	D	E	F
Port Size	Out=5/16" or 8mm			Out=3/8"					
Orifice Size*	Cv=1.0		Cv=0.5		Cv=1.2			Cv=0.5	
Fluid	Air (to be filtered by 40μ filter element)								
Nom Pressure	Vacuum - 145 psi (vacuum - 10 bar) valve supply / 45-100 psi (3-7 bar) pilot supply								
Voltage ±10%	24VDC								
Power Consumption	0.9W (per solenoid)								
Max Frequency	8 cycles/sec								
Insulation	F class (155°C / 311°F max coil only)								
Min Response	8ms	20ms		8ms			20ms		
Temperature	-10-60°C [14-140°F]								
Lubrication	Filtered air without lubrication; lubrication, if used, must be continuous								
Protection	IP65 (when using NITRA cables)								
Body	Aluminum with technopolpolymer (Celcon) shell								
Agency Approvals	None								

\* Cv test conditions of 90psi inlet, ΔP = 14.5 psi, temperature 70°F (21.1°C)





# Compact Modular Valves

## Compact Modular Valves - Intermediate Modules

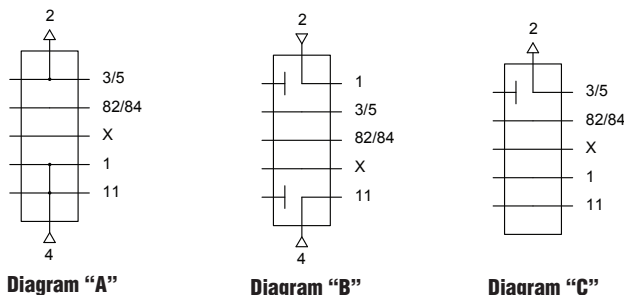
In applications with a large number of high flow valves, an intermediate through module ([CMV-D1X-3X](#)) provides additional air inlets. If dual pressures are desired in a manifold, an intermediate blind module ([CMV-D2X-3X](#)) provides an independent supply to valves to its right while blocking the main supply from the left. For applications requiring quicker exhaust on some valves, an intermediate exhaust module ([CMV-D3X-3X](#)) provides a dedicated exhaust for valves to its right while blocking exhaust from valves to its left.



Compact Modular Valve - Intermediate Modules					
Item	Part No.	Price	Description	Diagram	Weight (lbs)
	<a href="#">CMV-D1X-3X</a>	\$62.00	NITRA pneumatic modular plate, intermediate, through, (2) 5/16 inch (8 mm) push-to-connect tubing inlet port(s), Cv=0.65, reinforced technopolymer body. For use with CMV series solenoid valves.	A	0.3
	<a href="#">CMV-D2X-3X</a>	\$60.00	NITRA pneumatic modular plate, intermediate, blind, (2) 5/16 inch (8 mm) push-to-connect tubing inlet port(s), Cv=0.65, reinforced technopolymer body. For use with CMV series solenoid valves.	B	0.3
	<a href="#">CMV-D3X-3X</a>	\$55.00	NITRA pneumatic modular plate, intermediate, exhaust, 5/16 inch (8 mm) push-to-connect tubing exhaust port, Cv=0.65, reinforced technopolymer body. For use with CMV series solenoid valves.	C	0.3

## Dimensions

mm [inches]

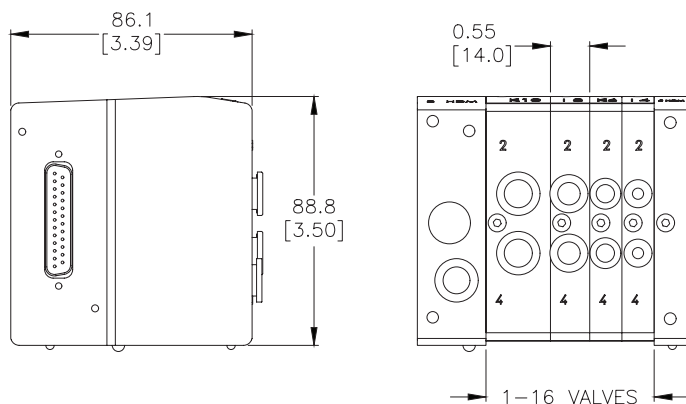

See our website [www.AutomationDirect.com](http://www.AutomationDirect.com) for complete Engineering drawings.





# Compact Modular Valves

Compact Modular Valve Accessories				
Item	Part No.	Price	Description	Weight (lbs)
	<a href="#"><u>CMV-SW-USB</u></a>	\$12.00	NITRA configuration software, USB. For use with CMV series EtherNet/IP modules. OS compatibility: Windows XP, 32 bit Windows 7, 64 bit Windows 8, 32 & 64 bit Win 8.1, 32 & 64 bit Win 10, 64 bit	0.1
	<a href="#"><u>CMV-ACC01</u></a>	\$41.00	NITRA pigtail cable, 25-pin D-sub female connector, IP65, 45 degree cable entry, 28AWG, 1 meter (3.3 ft.) length	0.4
	<a href="#"><u>CMV-ACC02</u></a>	\$54.00	NITRA pigtail cable, 25-pin D-sub female connector, IP65, 45 degree cable entry, 28AWG, 2.5 meter (8.2 ft.) length	0.9
	<a href="#"><u>CMV-ACC03</u></a>	\$76.00	NITRA pigtail cable, 25-pin D-sub female connector, IP65, 45 degree cable entry, 28AWG, 5 meter (16.4 ft.) length	1.6
	<a href="#"><u>CMV-ACC04</u></a>	\$9.00	NITRA pneumatic mounting bracket, attaches CMV series valve assemblies to 35mm DIN rail. Includes mounting screws.	0.1
	<a href="#"><u>CMV-ACC06</u></a>	\$3.00	NITRA pneumatic release tool, for push-to-connect fittings, tube diameters 1/8 inch through 3/8 inch	0.1
	<a href="#"><u>CMV-ACC07</u></a>	\$1.50	NITRA pneumatic release tool, for push-to-connect fittings, tube diameters 5/32 inch through 1/2 inch	0.1
	<a href="#"><u>CMV-ACC08</u></a>	\$4.00	NITRA pneumatic screw set, replacement, for CMV series solenoid valves. Includes (1) M4-0.7x5 cone point screw and (1) M4-0.7x34 cone point screw.	0.1
	<a href="#"><u>CMV-ACC09</u></a>	\$6.25	NITRA pneumatic gasket, replacement, for CMV series solenoid valves. 5 per package.	0.1





# Compact Modular Valves - Accessories

Compact Modular Valve Accessories				
<i>Item</i>	<i>Part No.</i>	<i>Price</i>	<i>Description</i>	<i>Weight (lbs)</i>
	<b><u>CMV-ACC10</u></b>	\$5.00	NITRA pneumatic molded O-ring, replacement, for CMV series solenoid valves. 5 per package.	0.1
	<b><u>CMV-ACC11</u></b>	\$22.50	NITRA connector, 25-pin female D-sub, 45-degree cable entry, accepts 0.19 to 0.39 inch diameter cable, accepts wire size 22 - 18 AWG, solder connections, IP65. For use with CMV series solenoid valves.	0.2
	<b><u>CMV-ACC12</u></b>	\$2.75	NITRA blank marking tag, replacement. Package of 10. For use with CMV cable connectors.	0.1