

# Roman Census: Enumerating and Counting Roman Dominating Functions on Graph Classes

Faisal N. Abu-Khzam<sup>1</sup>[0000-0001-5221-8421], Henning Fernau<sup>2</sup>[0000-0002-4444-3220], and Kevin Mann<sup>2</sup>[0000-0002-0880-2513]

<sup>1</sup> Department of Computer Science and Mathematics  
Lebanese American University, Beirut, Lebanon.

faisal.abukhzam@lau.edu.lb

<sup>2</sup> Universität Trier, Fachbereich 4 – Abteilung Informatikwissenschaften  
54286 Trier, Germany.  
{fernau,mann}@uni-trier.de

**Abstract** The concept of Roman domination has recently been studied concerning enumerating and counting (WG 2022). It has been shown that minimal Roman dominating functions can be enumerated with polynomial delay, contrasting what is known about minimal dominating sets. The running time of the algorithm could be estimated as  $\mathcal{O}(1.9332^n)$  on general graphs of order  $n$ . In this paper, we focus on special graph classes. More specifically, for chordal graphs, we present an enumeration algorithm running in time  $\mathcal{O}(1.8940^n)$ . For interval graphs, we can lower this time further to  $\mathcal{O}(1.7321^n)$ . Interestingly, this also matches (exactly) the known lower bound. We can also provide a matching lower and upper bound for forests, which is (incidentally) the same, namely  $\mathcal{O}(\sqrt{3}^n)$ . Furthermore, we show an enumeration algorithm running in time  $\mathcal{O}(1.4656^n)$  for split graphs and for cobipartite graphs. Our approach also allows to give concrete formulas for counting minimal Roman dominating functions on special graph families like paths.

## 1 Introduction

ROMAN DOMINATION comes with a nice (hi)story, on how to position armies on the various regions to secure the Roman Empire. ‘To secure’ means that either (1) a region  $r$  has at least one army or (2) a region  $r'$  neighboring  $r$  contains two armies, so that it can afford sending one army to the region  $r$  without diminishing  $r'$ ’s self-defense capabilities. More specifically, Emperor Constantine had a look at a map of his empire (as discussed in [63], also see Figure 1).<sup>3</sup>

ROMAN DOMINATION has received notable attention during the last two decades [8, 20, 28, 31, 48, 49, 52, 57, 58, 61].

<sup>3</sup> The historical background is also nicely described in the online Johns Hopkins Magazine, visit <http://www.jhu.edu/~jhumag/0497web/locate3.html> to pre-view [59].

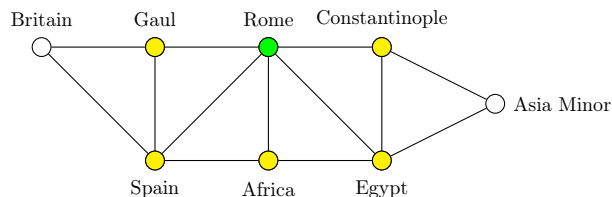

Figure 1: The Roman Empire in the times of Constantine: Putting 2 armies on Rome also secures all neighboring regions (colored yellow), leaving only two regions to be secured by one army each.

Relevant to our work is the development of exact algorithms. The algorithm presented in [62] combines ideas from [48, 64] and solves the (optimization) problem in  $\mathcal{O}(1.5014^n)$  time (and space). More combinatorial studies can be found in [18, 21, 30, 39, 47, 50, 51, 55, 65, 66, 67] as well as the more recent chapter on Roman domination in [38]. Another interesting related notion is the *differential* of a graph, introduced in [54]. See also [11], for further algorithmic thoughts, as noted in [3, 9, 10]. To briefly summarize all these findings, one can say that in many ways concerning complexity, ROMAN DOMINATION and DOMINATING SET behave exactly the same way. There are two notable and related exceptions, as delineated in [4], concerning *extension problems* and *output-sensitive enumeration*.

*Extension problems* often arise from search-tree algorithms for their optimization counterpart as follows. Assume that a search-tree node corresponds to a partial solution (or pre-solution)  $U$  and instead of proceeding with the search-tree algorithm (by exploring all the possible paths from this node onward) we ask whether we can extend  $U$  to a meaningful solution  $S$ . In the case of DOMINATING SET, this means that  $S$  is an inclusion-wise minimal dominating set that contains  $U$ . Unfortunately, this EXTENSION DOMINATING SET problem and many similar problems are NP-hard, see [6, 13, 15, 16, 43, 44, 53]. Even worse: when parameterized by the ‘pre-solution size,’ EXTENSION DOMINATING SET is one of the few problems known to be complete for the parameterized complexity class  $W[3]$ , as shown in [12]. This blocks any progress on the HITTING SET TRANSVERSAL PROBLEM by using extension test algorithms, which is the question whether all minimal hitting sets of a hypergraph can be enumerated with polynomial delay (or even output-polynomial) only. This question is open for four decades by now and is equivalent to several enumeration problems in logic, database theory and also to enumerating minimal dominating sets in graphs, see [26, 29, 33, 42].

By way of contrast and quite surprisingly, with an appropriate definition of the notion of minimality, the extension variant of ROMAN DOMINATION is

solvable in polynomial-time as shown in [4]. This enabled us to show that enumerating all minimal Roman dominating functions is possible with polynomial delay. This also triggered our interest in looking further into enumerating minimal Roman dominating functions on graph classes, as also done in the case of DOMINATING SET, see [5, 24, 25, 35, 36]. The basis of the output-sensitive enumeration result of [4] was several combinatorial observations. Here, we find ways how to use these underlying combinatorial ideas for non-trivial enumeration algorithms for minimal Roman dominating functions in split graphs, cobipartite graphs, interval graphs, forests and chordal graphs and for counting these exactly for paths. All these graph classes will be explained in separate sections below. These exploits constitute the main results of this paper. More details can be found at the end of the next section.

## 2 Definitions and Known Results

Let  $\mathbb{N} = \{1, 2, 3, \dots\}$  be the set of positive integers. For  $n \in \mathbb{N}$ , let  $[n] = \{m \in \mathbb{N} \mid m \leq n\}$ . We only consider undirected simple graphs. Let  $G = (V, E)$  be a graph. For  $U \subseteq V$ ,  $G[U]$  denotes the graph induced by  $U$ . For  $v \in V$ ,  $N_G(v) := \{u \in V \mid \{u, v\} \in E\}$  denotes the *open neighborhood* of  $v$ , while  $N_G[v] := N_G(v) \cup \{v\}$  is the *closed neighborhood* of  $v$ . We extend such set-valued functions  $X : V \rightarrow 2^V$  to  $X : 2^V \rightarrow 2^V$  by setting  $X(U) = \bigcup_{u \in U} X(u)$ . Subset  $D \subseteq V$  is a *dominating set*, or ds for short, if  $N_G[D] = V$ . For  $D \subseteq V$  and  $v \in D$ , define the *private neighborhood* of  $v \in V$  with respect to  $D$  as  $P_{G,D}(v) := N_G[v] \setminus N_G[D \setminus \{v\}]$ . A function  $f : V \rightarrow \{0, 1, 2\}$  is called a *Roman dominating function*, or rdf for short, if for each  $v \in V$  with  $f(v) = 0$ , there exists a  $u \in N_G(v)$  with  $f(u) = 2$ . To simplify the notation, we define  $V_i(f) := \{v \in V \mid f(v) = i\}$  for  $i \in \{0, 1, 2\}$ . The *weight*  $w_f$  of a function  $f : V \rightarrow \{0, 1, 2\}$  equals  $|V_1| + 2|V_2|$ . The classical ROMAN DOMINATION problem asks, given  $G$  and an integer  $k$ , if there exists an rdf of weight at most  $k$ . Connecting to the original motivation,  $G$  models a map of regions, and if the region vertex  $v$  belongs to  $V_i$ , then we place  $i$  armies on  $v$ .

For the definition of the problem EXTENSION ROMAN DOMINATION, we need to define the order  $\leq$  on  $\{0, 1, 2\}^V$  first: for  $f, g \in \{0, 1, 2\}^V$ , let  $f \leq g$  if and only if  $f(v) \leq g(v)$  for all  $v \in V$ . In other words, we extend the usual linear ordering  $\leq$  on  $\{0, 1, 2\}$  to functions mapping to  $\{0, 1, 2\}$  in a pointwise manner. We call a function  $f \in \{0, 1, 2\}^V$  a *minimal Roman dominating function* if and only if  $f$  is a rdf and there exists no rdf  $g$ ,  $g \neq f$ , with  $g \leq f$ .<sup>4</sup> The weights of minimal rdf can vary considerably. Consider for example a star  $K_{1,n}$  with center  $c$ . Then,  $f_1(c) = 2$ ,  $f_1(v) = 0$  otherwise;  $f_2(v) = 1$  for all vertices  $v$ ;  $f_3(c) = 0$ ,  $f_3(u) = 2$  for one  $u \neq c$ ,  $f_3(v) = 1$  otherwise, define three minimal rdf with weights  $w_{f_1} = 2$ , and  $w_{f_2} = w_{f_3} = n + 1$ .

<sup>4</sup> According to [38], this notion of minimality for rdf was coined by Cockayne but then dismissed, as it does not give a proper notion of *upper Roman domination* number. However, in our context, this definition seems to be most natural one; it also fits the extension framework proposed in [17].

In [4], several combinatorial properties of minimal Roman dominating functions were derived that were central for obtaining a general algorithmic enumeration result and that are also important when studying special graph classes. This is summarized as follows.

**Theorem 1.** *Let  $G = (V, E)$  be a graph,  $f : V \rightarrow \{0, 1, 2\}$  and abbreviate  $G' := G[V_0(f) \cup V_2(f)]$ . Then,  $f$  is a minimal rdf if and only if the following conditions hold:*

1.  $N_G[V_2(f)] \cap V_1(f) = \emptyset$ ,
2.  $\forall v \in V_2(f) : P_{G', V_2(f)}(v) \not\subseteq \{v\}$ , also called privacy condition, and
3.  $V_2(f)$  is a minimal dominating set of  $G'$ .

This combinatorial result has been the key to show a polynomial-time decision procedure for the extension problem (concerning a given function  $f : V \rightarrow \{0, 1, 2\}$ ). But it can also be used to design enumeration algorithms that are also input-sensitive. The simplest exploit is to branch on all vertices whether or not a vertex should belong to  $V_2(f)$ . Once  $V_2(f)$  is fixed, its neighborhood will form  $V_0(f)$  and the remaining vertices will be  $V_1(f)$ . To achieve better running times, this approach has to be clearly refined. For more details, see section 5.

*Outline of the presentation* As a warm-up, we consider enumerating minimal rdf in split and cobipartite graphs, for which we present a very simple algorithm that does not make use of any more advanced techniques like Measure-and-Conquer. Then, we turn our attention to (exact) counting of minimal rdf on paths, an exercise that will turn out to be an important step for branching algorithms for forests and for interval graphs. In all these cases, we obtain enumeration algorithms that are provable optimal in the sense that there are possible input graphs that require the number of minimal rdf to be output as proved as an upper bound for the respective families of graphs. We conclude the paper with discussing the family of chordal graphs, where we present an enumeration algorithm with a running time substantially better than in the general case, although we do not know if the upper bound is tight.

### 3 Enumerating Minimal Roman Dominating Functions in Split and in Cobipartite Graphs

A split graph  $G = (V, E)$  consists of a bipartition of  $V$  as  $C$  and  $I$ , such that  $C$  forms a clique and  $I$  is an independent set. Let  $f : V \rightarrow \{0, 1, 2\}$  be a minimal rdf of  $G$ . Then, if  $V_2 = f^{-1}(2)$  contains both a vertex  $v_c$  from  $C$  and a vertex  $v_i$  from  $I$ , then  $v_i$  cannot find a private neighbor in  $G$ , contradicting minimality of  $f$ . We can hence first branch to decide if  $V_2 \subseteq C$  or if  $V_2 \subseteq I$ . After dealing with the simple case that  $|V_2 \cap C| = 1$  separately, we can assume that all private neighbors of  $V_2 \subseteq C$  are in  $I$  and that all private neighbors of  $V_2 \subseteq I$  are in  $C$ . We will describe a simple branching algorithm in which we can assume to

immediately delete vertices that are assigned the value 0, as they will be always dominated.

**Case 1.** One element of  $C$  is assigned a value of 2. We can guess this element in  $\mathcal{O}(n)$  and proceed as follows.

1. Elements of  $C$  with no neighbors in  $I$  are assigned a value of zero.
2. Pick  $v \in C$  with at least two neighbors in  $I$  and branch by either setting  $f(v) = 2$  and assign 0 to vertices in  $N(v) \cap I$  or  $f(v) = 0$  (this leads to the branching vector  $(3, 1)$ ).
3. When all elements of  $C$  have exactly one neighbor in  $I$ , pick some  $v \in C$  with  $N(v) \cap I = \{w\}$ . Distinguish two cases.
  - 3.1  $w$  has at least one other neighbor  $x \in C$ . Then either  $f(v) = 2, f(w) = f(x) = 0$  (in fact, all neighbors of  $w$  are assigned 0), or  $f(v) = 0$  (this leads to a  $(3, 1)$  branch).
  - 3.2  $N(w) = \{v\}$ : either  $f(v) = 2, f(w) = 0$  or  $f(v) = 0, f(w) = 1$  (this leads to the branching vector  $(2, 2)$ ).

**Case 2.** No element of  $C$  is assigned a value of 2.

1. Then any isolated element of  $I$  is automatically assigned a value of 1 and can be deleted. Moreover, any element of  $C$  with no neighbors in  $I$  is assigned a value of 1 and deleted.
2. Pick a vertex  $v$  of degree at least two in  $I$  and branch by either setting  $f(v) = 2$  and assigning zero to all its neighbors or set  $f(v) = 1$  (this leads to the branching vector  $(3, 1)$ ).
3. When all elements of  $I$  are pendant, pick  $v \in I$  with  $N(v) \cap C = \{w\}$ . Distinguish 2 cases.
  - 3.1  $w$  has at least one more neighbor  $x \in I$ : either  $f(v) = 2, f(w) = 0, f(x) = 1$  or  $f(v) = 1$  (delete  $v$ ) (this leads to the branching vector  $(3, 1)$ ).
  - 3.2  $N(w) \cap I = \{v\}$ : either  $f(v) = 2, f(w) = 0$  or  $f(v) = f(w) = 1$  (this leads to the branching vector  $(2, 2)$ ).

The worst-case branch vector is  $(1, 3)$ , which leads to the following claim.

**Theorem 2.** *All minimal rdf in a split graph of order  $n$  can be enumerated in time  $\mathcal{O}^*(1.4656^n)$ .*

For cobipartite graphs, a similar reasoning applies. Now, it could be possible that one vertex  $x$  of the bipartition side  $X$  finds its private neighbor  $p_x$  in  $X$  itself and that one vertex  $y$  of the other bipartition side  $Y$  finds its private neighbor  $p_y$  in  $Y$ , such that the edges  $xp_y$  and  $yp_x$  do not exist. If  $G$  contains no universal vertices, then irrespectively whether the  $V_2$ -vertices lie in  $X$  or in  $Y$ , there must be at least one other vertex in  $V_2$  on the same side. But this means that they must find their private neighbors on the other side. The branching is hence analogous to the split graph case.

**Theorem 3.** *All minimal rdf in a cobipartite graph of order  $n$  can be enumerated in time  $\mathcal{O}^*(1.4656^n)$ .*

The previous arguments are not valid in the case of bipartite graphs. Here, we rather suspect that the general case is not really easier than the bipartite case.

For the lower bound for split graphs (cobipartite graphs have a have similar example) we look at the graph  $G = (C \cup I, E)$  with  $C = \{c_1, \dots, c_n\}$ ,  $I = \{v_1, \dots, v_n\}$  and  $E = \binom{C}{2} \cup \{\{c_1, v_1\}, \dots, \{c_n, v_n\}\}$  (for the cobipartite case  $I$  is also a clique). For  $c_i \in V_2 \subseteq C$ ,  $v_i$  would be a private neighbor and  $c_i$  would be a private neighbor for  $v_i \in V_2 \subseteq I$ . Thus, each subset of  $C$  and each subset of  $I$  is a possible choice for  $V_2$ . Therefore,  $G$  has  $2 \cdot \sqrt{2}^n - 1$  minimal rdf (for the cobipartite case there are  $2 \cdot \sqrt{2}^n + \frac{n^2}{4} - 1$  possibilities, since we could also choose any vertex of  $C$  together with any vertex of  $I$ ).

**Corollary 1.** *There exist split and cobipartite graphs of order  $n$  with  $\Omega(\sqrt{2}^n)$  many minimal rdf.*

## 4 Counting Minimal Roman Dominating Functions on Paths

In this section, we will develop formulas for the number of minimal Roman dominating functions on paths.

Let  $C_{P,n}$  count the number of minimal rdf of a  $P_n$ . Furthermore, let  $C_{P,2,n}$  and  $C_{P,\bar{2},n}$  denote the number of minimal rdf of a  $P_n$  where the first vertex is assigned 2, or where it is decided that the first vertex is not assigned 2, respectively. Clearly,

$$C_{P,n} = C_{P,2,n} + C_{P,\bar{2},n}.$$

Consider  $P_n = (V_n, E_n)$  with  $V_n = \{v_i \mid i \in [n]\}$  and  $E_n = \{v_i v_{i+1} \mid i \in [n-1]\}$ . Let  $n \geq 3$  and  $f : V_n \rightarrow \{0, 1, 2\}$  be a minimal rdf. If  $f(v_1) = 2$ , then  $f(v_2) = 0$  and it is clear that  $f(v_3) \neq 2$ . This shows (including trivial initial cases):

$$C_{P,2,n} = \begin{cases} 0, & \text{if } n = 1 \\ 1, & \text{if } n = 2 \\ C_{P,\bar{2},n-2}, & \text{if } n > 2 \end{cases}$$

If  $f(v_1) \neq 2$ , then we have two subcases: (a) if  $f(v_1) = 1$ , then we know that  $f(v_2) \neq 2$ ; (b) if  $f(v_1) = 0$ , then  $f(v_2) = 2$  is enforced. But we know a bit more compared to the initial situation: This 2 on  $v_2$  has already a private neighbor, namely  $v_1$ . Therefore, we have more possibilities for  $v_3$ : either  $f(v_3) = 0$  or  $f(v_3) = 2$ . The second subcase is as before, because this 2 has no private neighbor. If  $f(v_3) = 0$ , then either  $f(v_4) = 2$ , and this 2 has no private neighbor, or  $f(v_4) \neq 2$ . Hence, we find the recursion established in Figure 2.

Now,  $C_{P,n} = C_{P,2,n} + C_{P,\bar{2},n} = C_{P,\bar{2},n-2} + C_{P,\bar{2},n-1} + C_{P,2,n-2} + C_{P,n-3} = C_{P,\bar{2},n-1} + C_{P,n-2} + C_{P,n-3}$ . Conversely,  $C_{P,n} = C_{P,2,n} + C_{P,\bar{2},n} = C_{P,\bar{2},n-2} + C_{P,\bar{2},n}$ . Hence,  $C_{P,n} = C_{P,\bar{2},n} + C_{P,\bar{2},n-2} = C_{P,\bar{2},n-1} + (C_{P,\bar{2},n-2} + C_{P,\bar{2},n-4}) + (C_{P,\bar{2},n-3} + C_{P,\bar{2},n-5})$ , which gives, ignoring the cases for small values of  $n$ :

$$C_{P,\bar{2},n} = C_{P,\bar{2},n-1} + C_{P,\bar{2},n-3} + C_{P,\bar{2},n-4} + C_{P,\bar{2},n-5} \approx 1.6852^n$$

As  $C_{P,n} = C_{P,\bar{2},n-2} + C_{P,\bar{2},n}$ , the same asymptotic behavior holds for  $C_{P,n}$ , i.e.,  $C_{P,n} = \mathcal{O}^*(1.6852^n)$ .

$$C_{P,\bar{2},n} = \begin{cases} 1, & \text{if } n = 1 \\ 2, & \text{if } n = 2 \\ 3, & \text{if } n = 3 \\ C_{P,\bar{2},n-1} + C_{P,2,n-2} + \overbrace{C_{P,2,n-3} + C_{P,\bar{2},n-3}}{=C_{P,n-3}}, & \text{if } n > 3 \end{cases}$$

Figure 2: Recursion formula for minimal rdf of  $P_n$  not starting with the label 2.

**Proposition 1.** *The number of minimal Roman dominating functions of a path  $P_n$  grows as  $\mathcal{O}^*(c_{RD,P}^n)$ , with  $c_{RD,P} \leq 1.6852$ .*

This should be compared with the recursion of Bród [14] that yields the following asymptotic behavior for the number of minimal dominating sets of a path with  $n$  vertices:

**Corollary 2.** [14] *The number of minimal dominating sets of a path  $P_n$  grows as  $\mathcal{O}^*(c_{D,P}^n)$ , with  $c_{D,P} \leq 1.4013$ .*

As every minimal dominating set  $D \subseteq V$  of a graph  $G = (V, E)$  corresponds to the minimal rdf  $f : V \rightarrow \{0, 1, 2\}$  with  $f^{-1}(2) = D$  and  $f^{-1}(0) = V \setminus D$ , it is clear that  $c_{D,P} \leq c_{RD,P}$ .<sup>5</sup>

Apart from bringing insights into the number of minimal rdf of single paths of a certain length, our recursions are also helpful to determine how many minimal rdf can be in forests of paths. The interesting corner cases are here determined by the graph families  $\mathcal{P}_n$  that consists of the graph union of arbitrary many paths on  $n$  vertices, such that the order of each graph  $G \in \mathcal{P}_n$  is divisible by  $n$ . Table 1 shows the number of minimal rdf per connected component (i.e., it spells out  $C_{P,n}$ ) and the and branching numbers.

$n$	1	2	3	4	5	6	7
$C_{P,n}$	1	3	4	7	12	20	34
branching number	1	$\sqrt{3} \leq 1.7321$	1.5875	1.6266	1.6438	1.6476	1.6550

Table 1: Branching numbers for collections of paths

Hence, we can conclude:

**Corollary 3.** *Within the family of forests of paths, the number of minimal rdf for graphs of order  $n$  is  $\mathcal{O}(\sqrt{3}^n)$ , a value actually approached by  $\mathcal{P}_2$ .<sup>6</sup>*

<sup>5</sup> While the sequence of the numbers of minimal dominating sets of a  $P_n$  can be found in the Encyclopedia of Integer Sequences, this is not the case for the sequence of the numbers of minimal rdf of a  $P_n$ .

<sup>6</sup> We have a cumbersome argument that the intuition that the exponential growth will ‘win’ against the polynomial factors from 3 onwards.

We will further extend this result towards forests and towards interval graphs in the next sections, starting with a more general description of such branching algorithms for enumerating minimal rdf.

## 5 A General Approach to Branching for Minimal RDF

In this section, we sketch the general strategy that we apply for enumerating minimal rdf. In most cases, the branching will look for a yet undecided vertex  $v$  (that we will call *active* henceforth) and will decide to label it with 2 in one branch and not to label it with 2 in the other branch. Now, in the first branch, we can say something about the neighbors of  $v$  as well: according to Theorem 1, they cannot be finally labelled with 1. We express this and similar properties by (always) splitting the vertex set  $V$  of the current graph  $G = (V, E)$  into:

- $A$ : notice that in the very beginning of the branching, all vertices are active.
- $\overline{V}_i$ : vertices that cannot be assigned a value of  $i$ ,  $i \in \{1, 2\}$ .
- $V_0$ : set of vertices assigned a value of zero that are not yet dominated.

Sometimes, the branching also considers a vertex from  $\overline{V}_1$ , which will be assigned 0 (and hence is deleted) in the branch when it is not assigned 2. We can also call extendibility tests before doing the branching in order to achieve polynomial delay; see [4].

Possibly, we can also (temporarily) have (and speak of) vertex sets  $V_i$  (with  $i \in \{1, 2\}$ ) with the meaning that each vertex in  $V_i$  is assigned the value  $i$ . Our algorithms will preserve the invariant that a vertex  $v \in \overline{V}_1$  must have a neighbor put into  $V_2$  (in the original graph). However, notice that once the effect (mostly implied by Theorem 1) of putting a vertex  $v$  into  $V_i$  on its neighborhood  $N(v)$  has been taken care of, these vertices can be deleted from the ‘current graph’ to simplify the considerations. More precisely, for  $i \in \{1, 2\}$ , our algorithms automatically delete vertices assigned a value of  $i$  after making sure the neighbors are placed in  $\overline{V}_{3-i}$ . It could happen that the neighbor of a vertex  $w \in \overline{V}_2$  is assigned the value 2. Then,  $w$  must be assigned 0; as it is dominated, it can and will be deleted. Similarly, if the neighbor of a vertex  $w \in \overline{V}_1$  is assigned the value 1,  $w$  must be assigned 0 and is hence deleted. Only finally, it should be checked if a function  $f : V \rightarrow \{0, 1, 2\}$  that is constructed during branching is indeed a minimal rdf, because possibly some vertices assigned 2 do not have a private neighbor. During the course of our algorithm, whenever we speak of the degree of a vertex (in the current graph) in the following, we only count in neighbors in  $\overline{V}_1 \cup \overline{V}_2 \cup A$ . We sometimes abbreviate  $V_0 \cup \overline{V}_2 \cup \overline{V}_1$  as  $\widehat{V}_2$ .

Reduction rules are an important ingredient of any branching algorithm. We will make use of the following reduction rules. Rules in similar form appeared in [4].

**Reduction Rule 1** *If  $v \in \overline{V}_2$  with  $N(v) \subseteq \overline{V}_2$ , then set  $f(v) = 1$  and delete  $v$ .*

**Reduction Rule 2** *If  $v \in \overline{V}_1$  with  $N(v) \subseteq \overline{V}_1$ , then set  $f(v) = 0$  and delete  $v$ .*



**Reduction Rule 3** *If  $v \in A$  obeys  $N(v) \subseteq \overline{V_1}$ , then put  $v$  into  $\overline{V_2}$ .*

**Lemma 1.** *The three reduction rules are sound.*

*Proof.* First consider  $v \in \overline{V_2}$  with  $N(v) \subseteq \overline{V_2}$ . If  $v$  would be assigned 0, then it would need a neighbor assigned 2 to dominate it. Therefore, only the possibility to assign 1 to  $v$  remains. Secondly, consider  $v \in A \cup \overline{V_1}$  with  $N(v) \subseteq \overline{V_1}$ . If  $v$  would be assigned 2, then  $v$  must need a private neighbor in  $N(v)$ . As all of  $N(v)$  is part of  $\overline{V_1}$ , by our invariant this means that all these vertices are already dominated. Therefore,  $v$  cannot be assigned 2.  $\square$

Similarly as in [4], we will perform a Measure-and-Conquer analysis of the branching algorithms that we will describe. As a measure, we take

$$\mu(A, \overline{V_1}, \overline{V_2}, V_0) = |A| + \omega_1 |\overline{V_1}| + \omega_2 |\overline{V_2}|$$

for the ‘current graph’ with vertex set  $A \cup \overline{V_1} \cup \overline{V_2} \cup V_0$ . In the beginning of the algorithm,  $A = V$  and  $\overline{V_1} = \overline{V_2} = V_0 = \emptyset$ . To explain the work of the reduction rules, consider an isolated vertex (in the very beginning). The reduction rules will first move it into  $\overline{V_2}$  and then into  $V_1$  to finally delete it.

We will choose the constants  $\omega_1, \omega_2 \in [0, 1]$  to assess the running times of our algorithms best possible, hence also delivering upper bounds on the number of minimal rdf of graphs of order  $n$  belonging to a specific graph class.

Concerning the reduction rules, we can easily observe that their application will never increase the measure. We will list in the following several branching rules (for the different graph classes) and we always assume that the rules are carried out in the given order.

## 6 Enumerating Minimal RDF on Interval Graphs

Recall that an *interval graph* can be described as the intersection graph of a collection of intervals on the real line. This means that the vertices correspond to intervals and that there is an edge between two such vertices if the intervals have a non-empty intersection. We assume in the following that  $G = (V, E)$  is an interval graph with the interval representation  $\mathcal{I} = \{I_v := [l_v, r_v]\}_{v \in V}$ , i.e.,  $l_v$  is the left border and  $r_v$  is the right border of the interval representing the vertex  $v$ . We call  $v \in U$  *leftmost in  $U$*  if it is a vertex from  $U$  that has the smallest value of  $r_u$  among all vertices in  $U$ . A vertex leftmost in  $V$  is simply called leftmost.

As we are rather dealing with the partition of the vertex set of the current graph into  $A, \overline{V_1}, \widehat{V_2}$  in the following branching algorithm for interval graphs, we re-formulate Reduction Rules 2 and 3 as one rule:

**Reduction Rule 4** *Let  $v \in A \cup \overline{V_1}$  with  $N(v) \subseteq \overline{V_1} \cup (\widehat{V_2} \setminus \overline{V_2})$ . Then put  $v$  into  $\widehat{V_2}$ .*

Reduction Rule 4 implies that each vertex in  $v \in A$  has at least one neighbor in  $A \cup \overline{V_2}$ . Concerning the measure, we will have  $\omega_1 = 1$  and set  $\omega_2 = \omega = 0.57$ . We

are now going to present the branching rules that constitute the backbone of our algorithm for enumerating minimal rdf on interval graphs. For the convenience of the reader, we also provide illustrations of the different branching scenarios. In these figures, we adhere to the following drawing conventions:

- $\circ$  are vertices in  $A$ .
- $\bullet$  are vertices in  $\overline{V_1}$
- $\square$  are vertices in  $\overline{V_2}$
- $\diamond$  are vertices in  $A \cup \overline{V_2}$ , for which the exact set is not further defined.
- $\blacklozenge$  are vertices in  $A \cup \overline{V_1} \cup \overline{V_2}$ , for which the exact set is not further defined.

**Branching Rule 1** *Let  $v$  be the leftmost vertex in  $\overline{V_1}$  and let  $u$  be the leftmost vertex in  $N(v) \cap (A \cup \overline{V_2})$  and branch as follows:*

1. Put  $v$  in  $\widehat{V_2}$ .
2. Put  $v$  in  $V_2$  and  $u \in \widehat{V_2}$  (if it is not there yet).

**Lemma 2.** *The branching is a complete case distinction. Moreover, it leads at least to the following branching vector:  $(1, 1 + \omega)$ .*

*Proof.* Assume there exists a minimal rdf  $f$  with  $V_2(f) \cap (V_2 \cup \widehat{V_2}) = V_2$ . To prove that this is a complete case distinction, we show: if  $v \in V_2(f)$  holds,  $u \in V_0(f)$  is the private neighbor of  $v$ . Let  $w \in V_2 \cap N[v]$ . By Reduction Rule 4,  $N[v] \setminus N[w]$  is not empty. By the construction of the algorithm (look at the proof of Theorem 4, marked (\*)) and the minimality of  $f$  ( $I_v \not\subseteq I_w$ ),  $l_w < l_v < r_w < r_v$  holds.

Case 1:  $I_u \subseteq I_v$ . Thus  $f(u) \neq 2$ . If  $u$  is not a private neighbor of  $v$ , then there exists a  $t \in V_2(f) \cap N(v)$ . Because of the minimality of  $f$ ,  $l_v < l_t < r_u < r_v < r_t$  holds. Since  $v$  needs a private neighbor, there exists  $p \in N(v) \setminus N[\{w, t\}]$ . This implies  $I_p \cap I_v \subseteq I_v \setminus \{I_w \cup I_t\} = (r_w, l_t)$ . This is a contradiction to the minimality of  $u$ .

Case 2:  $I_u \not\subseteq I_v$ . Since  $u$  is not dominated by  $V_2$ , we have  $l_w < l_v < r_w < l_u < r_v < r_u$ . Assume there exists a  $t \in N[u] \cap V_2(f)$ . By minimality of  $f$ ,  $I_t \not\subseteq I_v$ ,  $I_v \not\subseteq I_w \cup I_t$  and there exists a  $p \in N(v) \setminus N[\{w, t\}]$ . This implies  $I_p \cap I_v \subseteq I_v \setminus (I_w \cup I_t) = (r_w, l_t) \subseteq (r_w, r_u)$ . This contradicts the minimality of  $r_u$ .

Thus,  $u$  has to be the private neighbor of  $v$ . Therefore, the measure is decreased by  $1 + \omega$ , if  $v \in V_2$ . Since  $v$  is already dominated, it would move into  $\widehat{V_2} \setminus \overline{V_2}$  if it is put into  $\widehat{V_2}$ . This decreases the measure by one.  $\square$

**Branching Rule 2** *Let  $v$  be the leftmost vertex in  $(A \cup \overline{V_2})$ . If  $v \in A$  and  $N(v) \cap A = \emptyset$  hold, branch as follows:*

1. Put  $v$  in  $V_2$ .
2. Put  $v$  in  $\widehat{V_2}$ .

**Lemma 3.** *The branching is a complete case distinction. Moreover, it leads at least to the following branching vector:  $(1 + \omega, 1)$ .*



Figure 3: Branching Rules 1 and 2

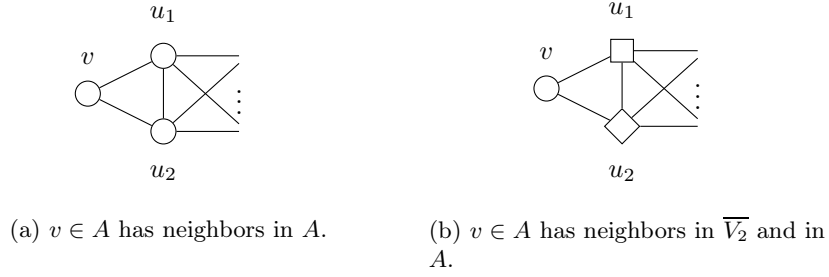

Figure 4: Branching Rules 3 and 4

*Proof.* It is clear that this is a complete case distinction. Because of Reduction Rule 4, we get  $N(v) \cap \overline{V_2} \neq \emptyset$ . Assume there exists a minimal rdf  $f$  with  $V_2(f) \cap (V_2 \cup \widehat{V_2}) = V_2$ . If  $f(v) = 2$ , the vertices in  $N(v) \cap \overline{V_2}$  would be dominated now. This decreases the measure by at least  $1 + \omega$ . If  $f(v) \neq 2$ , it would be in  $\widehat{V_2} \setminus \overline{V_2}$ , as it has no neighbor in  $A$ . Thus, the measure is decreased by at least 1.  $\square$

**Branching Rule 3** Let  $v$  be leftmost in  $(A \cup \overline{V_2})$ . If  $v \in A$  and  $|N(v) \cap A| \geq 2$  hold, branch as follows:

1. Put  $v$  in  $V_2$  and all vertices in  $N(v) \cap A$  into  $\widehat{V_2}$ .
2. Put  $v$  in  $\widehat{V_2}$ .

**Lemma 4.** The branching is a complete case distinction. Moreover, it leads to a branching vector not worse than  $(3, 1 - \omega)$ .

*Proof.* Assume there exists a minimal rdf  $f$  with  $V_2(f) \cap (V_2 \cup \widehat{V_2}) = V_2$ . The second branch is clear (also concerning the measure). For the first branch, we assume there exists a  $u \in N(v) \cup A$  with  $f(u) = f(v) = 2$ . Since both need a private neighbor,  $I_v \not\subseteq I_u$  holds. This implies  $l_v < l_u < r_v < r_u$ . Let  $y \in N(v) \cap (A \cup V_2)$  be the private neighbor of  $v$ . Therefore,  $I_v \cap I_y \subseteq I_v \setminus I_u = [l_v, l_u)$  holds. Thus  $r_y < r_v$ . This would contradict the minimality of  $v$ . This implies that this branching is a complete case distinction. Since we lose the weight of three vertices in  $A$ , all from  $N[v] \cap A$ , the measure decreases by at least 3.  $\square$

**Branching Rule 4** Let  $v$  be the leftmost vertex in  $(A \cup \overline{V_2})$ . If  $v \in A$ ,  $|N(v) \cap \overline{V_2}| \geq 1$  and  $|N(v) \cap A| = 1$  with  $u \in N(v) \cap A$  hold, then branch as follows:

1. Put  $v$  in  $V_2$  and  $u$  into  $\widehat{V}_2$ .
2. Put  $u$  in  $V_2$  and  $v$  in  $\widehat{V}_2$ .
3. Put  $u, v$  in  $\widehat{V}_2$ .

**Lemma 5.** *The branching is a complete case distinction. Moreover, it leads to a branching vector not worse than  $(2 + \omega, 2 + \omega, 2 - \omega)$ .*

*Proof.* First we show that  $N(v) \cap (A \cup \overline{V}_2)$  is a clique. Let  $x \in N(v) \cap (A \cup \overline{V}_2)$ . Thus, we find  $r_v < r_x$  and  $I_v \cap I_x \neq \emptyset$ . Hence, there exists a  $t \in I_v \cap I_x$  with  $t < r_v$ , so that  $[t, r_v] \subseteq I_x$  holds. This implies  $r_v \in I_x$  for each  $x \in N(v) \cap (A \cup \overline{V}_2)$  and  $N(v) \cap (A \cup \overline{V}_2)$  is a clique.

Since  $v$  is simplicial on  $G[A \cup \overline{V}_2]$ ,  $N_{G[A \cup \overline{V}_2]}(v) \subseteq N_{G[A \cup \overline{V}_2]}(u)$  holds. Thus, for  $v, u \in V_2$ ,  $v$  has no private neighbor. This contradicts the minimality of a minimal rdf.

In the first branch, the measure decreases by at least  $2 + \omega$ , since  $v$  gets into  $V_2$ ,  $u$  gets into  $\widehat{V}_2$  and all vertices in  $N(v)$  are dominated.

As  $N[v] \cap (A \cup \overline{V}_2)$  is a clique, it is dominated by  $u$  in the second branch and the measure is decreasing by  $2 + \omega$ .

In the third branch, we put  $v$  into  $\widehat{V}_2 \setminus \overline{V}_2$ , since there is no vertex in  $N[v] \cap A$  anymore. Furthermore,  $u$  moves into  $\widehat{V}_2$ . Thus, this case decreases the measure by  $2 - \omega$ .  $\square$

**Branching Rule 5** *Let  $v$  be the leftmost vertex in  $(A \cup \overline{V}_2)$ . If  $N[v] \cap A = \{u\}$  with  $N[v] \cap \overline{V}_2 = \emptyset$  and  $|N(u) \cap A| \geq 3$ , branch as follows:*

1. Put  $v$  in  $V_2$  and  $N[u] \setminus \{v\}$  in  $\widehat{V}_2$ .
2. Put  $v$  in  $\widehat{V}_2$ .

**Lemma 6.** *The branching is a complete case distinction. Moreover, it leads to a branching vector not worse than  $(2 + 2 \cdot (1 - \omega), 1 - \omega)$ .*

*Proof.* Consider vertices  $u, v$  as described in the branching rule. Let  $f : V \rightarrow \{0, 1, 2\}$  be a minimal rdf with  $V_2 \subseteq V_2(f)$  and  $\widehat{V}_2 \cap V_2(f) = \emptyset$ . If  $v \in V_2(f)$ , then  $u$  has to be the private neighbor of  $v$ . This implies  $(N[u] \setminus \{v\}) \cap V_2(f) \neq \emptyset$ . Therefore, the measure decreases by  $2 + (|N(u) \cap A| - 1) \cdot (1 - \omega) \geq 2 + 2 \cdot (1 - \omega)$ . The other case is trivial.  $\square$

**Branching Rule 6** *Let  $v_1$  be the leftmost vertex in  $(A \cup \overline{V}_2)$ . If  $N[v_1] \cap A = \{v_2\}$  with  $N[v_1] \cap \overline{V}_2 = \emptyset$ ,  $N(v_2) \cap A = \{v_1, v_3\}$  and if there exists a  $u \in N(v_3)$  such that  $N(u) = \{v_3\}$ , then branch as follows:*

1. Put  $v_1$  into  $V_2$  and  $v_2, v_3$  into  $\widehat{V}_2$ .
2. Put  $v_1, v_2$  into  $\widehat{V}_2$ .
3. Put  $v_2$  into  $V_2$  and  $v_1, v_3, u$  into  $\widehat{V}_2$ .
4. Put  $v_2, v_3$  into  $V_2$  and  $v_1, u$  into  $\widehat{V}_2$ .



(a)  $v_1 \in A$  has only one neighbor in  $A$  which has degree bigger than 2. (b)  $v_1, v_2, v_3 \in A$  is a path and  $v_3$  has a pendant neighbor.

Figure 5: Branching Rules 5 and 6

**Lemma 7.** *The branching is a complete case distinction. Moreover, it leads to a branching vector not worse than  $(3 - \omega, 2 - \omega, 4, 4)$ .*

*Proof.* Let  $f : V \rightarrow \{0, 1, 2\}$  be a minimal rdf with  $V_2 \subseteq V_2(f)$  and  $\widehat{V}_2 \cap V_2(f) = \emptyset$ . The first case is equivalent to the first case in Branching Rule 5. The second case is trivial. Assume  $v_2 \in V_2(f)$ . Therefore,  $u$  can not have the value 2. Otherwise, it has no private neighbor (except itself). In the last two cases, the measure decreases by 4 since  $v_3$  has a fixed value, is dominated and  $N[u] \cap A = \emptyset$ .  $\square$

**Branching Rule 7** *Let  $v_1$  be the leftmost vertex in  $(A \cup \overline{V}_2)$ , such that  $N[v_1] \cap A = \{v_2\}$ , with  $N[v_2] \cap \overline{V}_2 = \emptyset$  and  $N(v_2) \cap (A \cup \overline{V}_2) = \{v_1, v_3\}$ . If there exists a  $u$  that is leftmost in  $A \setminus \{v_1, v_2, v_3\}$ , with  $\{v_3\} \subsetneq N(u)$ , then branch as follows:*

1. Put  $v_1$  in  $V_2$  and  $v_2, v_3$  in  $\widehat{V}_2$ .
2. Put  $v_1, v_2$  in  $\widehat{V}_2$ .
3. Put  $v_2$  in  $V_2$  and  $v_1, v_3$  in  $\widehat{V}_2$ .
4. Put  $v_2, v_3$  in  $V_2$  and  $v_1, N[u] \setminus \{v_3\}$  in  $\widehat{V}_2$ .

**Lemma 8.** *The branching is a complete case distinction. Moreover, it leads to a branching vector not worse than  $(3 - \omega, 2 - \omega, 3, 5 - \omega)$ .*

*Proof.* We can assume there is no vertex  $w \in N(v_3)$  with  $N(w) = \{v_3\}$ . Otherwise, it would trigger Branching Rule 6. Let  $f : V \rightarrow \{0, 1, 2\}$  be a minimal rdf with  $V_2 \subseteq V_2(f)$  and  $\widehat{V}_2 \cap V_2(f) = \emptyset$ . The first two branchings are the same as in Branching Rule 6. Assume that  $f(v_1) \neq 2 = f(v_2)$ . If  $f(v_2) = 2 \neq f(v_3)$ , then vertex  $v_3$  is in  $\widehat{V}_2 \setminus \overline{V}_2$ , since it is already dominated. This explains the third branching, including the decrease of the measure.

The fourth branching needs most explanations, both concerning the completeness of the case distinction and the drop of the measure. Assume that  $f(v_1) \neq 2 = f(v_2) = f(v_3)$ . Then,  $v_3$  needs a private neighbor. Assume that this private neighbor is a vertex  $w \in N(v_3) \setminus \{v_2, u\}$ . We want to show that then  $u$  is also a private neighbor. We distinguish two cases.

Case 1:  $I_u \subseteq I_{v_3}$ . This implies  $u \notin V_2(f)$ . We know  $I_{v_2} \cap I_u = \emptyset$ . If  $u$  is not a private neighbor of  $v_3$ , then there exists a  $y \in N(u) \cap V_2(f)$ . Thus,

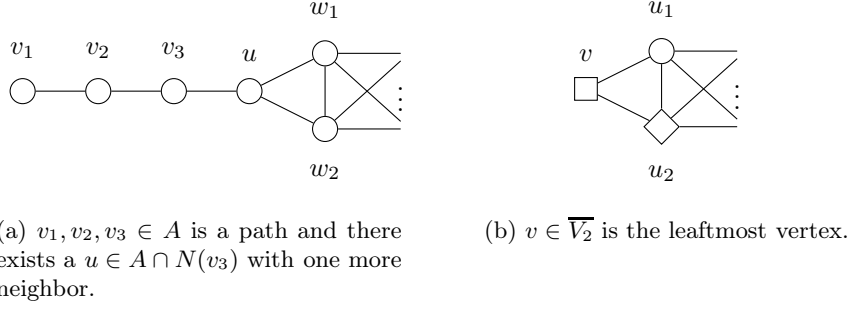

Figure 6: Branching Rules 7 and 8

$\emptyset \neq I_u \cap I_y \subseteq I_{v_3} \cap I_y$ . Furthermore, we know  $l_{v_3} < r_{v_2} < l_y$ . Having  $r_y < r_{v_3}$  would contradict Theorem 1. Therefore, we can assume  $r_{v_3} < r_y$ . For all  $z \in (N(v_3) \cap (A \cup \widehat{V}_2)) \setminus (N[y] \cup \{v_2\})$ , it holds that  $r_{v_2} < l_z$  and that  $r_z < l_y < r_u$ . But this would contradict with the minimality of  $r_u$ . Thus,  $N[v_3] \setminus \{v_2\} \subseteq N[y]$ , which then contradicts to the minimality of  $f$ .

**Case 2:**  $r_{v_3} < r_u$ . Assume there is a private neighbor  $x \in (N(v_3) \setminus \{u\}) \cap (A \cup \widehat{V}_2)$ . We want to show that  $N(u) \subseteq N(x)$ . Therefore, we assume

$$l_u < l_x < r_{v_3} < r_u < r_x.$$

Let  $z \in (N[u] \setminus N[x]) \cap (A \cup \widehat{V}_2)$ . Thus,  $I_u \cap I_z \subseteq I_u \setminus I_x = [l_u, l_x)$ . Therefore,  $r_z < l_x < r_u$  holds, which contradicts with the minimality of  $u$ . This implies  $N[u] \setminus (V_2 \setminus \{v_3\}) \subseteq N[x] \setminus (V_2 \setminus \{v_3\}) = \emptyset$ .

Thus, we can conclude that  $u$  is a private neighbor of  $v_3$ . Therefore,  $N[u] \setminus \{v_3\} \subseteq \widehat{V}_2$ . Since  $u$  has at least one neighbor that is not  $v_3$ , the measure loses  $5 - \omega$ .  $\square$

**Branching Rule 8** Let  $v$  be the leftmost vertex in  $(A \cup \widehat{V}_2)$ . If  $v \in \widehat{V}_2$ , branch as follows:

1. For each  $u \in N(v) \cap A$ :  $u$  in  $V_2$  and  $N(v) \setminus \{u\}$  into  $\widehat{V}_2$ .
2. Put  $N(v)$  in  $\widehat{V}_2$ .

**Lemma 9.** The branching is a complete case distinction. Moreover, it leads to a branching vector not worse than

$$\underbrace{(\omega + |N(v) \cap A|, \dots, \omega + |N(v) \cap A|, \omega + (1 - \omega) \cdot |N(v) \cap A|)}_{|N(v) \cap A| \text{ many times}}.$$

*Proof.* Let  $f : V \rightarrow \{0, 1, 2\}$  be a minimal rdf with  $V_2 \subseteq V_2(f)$  and  $\widehat{V}_2 \cap V_2(f) = \emptyset$ . Assume there exists  $x, y \in N(v) \cap A \cap V_2(f)$  with  $x \neq y$ . Without loss of generality,  $l_x < l_y < r_x < r_y$ . By the minimality of  $f$ , there exists a  $z \in N(x) \setminus N[y]$ . This

leads to  $I_x \cap I_z \subseteq I_x \setminus I_y = [l_x, l_y] \subseteq [l_x, r_v)$ . This contradicts to the minimality of  $v$ .

Therefore, at most one neighbor of  $v$  is in  $V_2(f)$ . Furthermore, the minimality of  $r_v$  implies  $r_v \in I_u$  for  $u \in A \cap N(v)$ . Since  $A \cap N(v)$  is a clique, the measure is decreased by  $\omega + |N(v) \cap A|$  if a vertex of  $A \cap N(v)$  moves into  $V_2$ . If all vertices move into  $\widehat{V}_2$ , the measure loses  $(1 - \omega) \cdot |N(v) \cap A|$ , because of the new vertices in  $\widehat{V}_2$ , and additionally  $\omega$ , since  $v$  has no neighbors in  $A$  anymore.  $\square$

**Lemma 10.** *For  $n \in \mathbb{N} \setminus \{0\}$  and  $\omega = 0.57$ , the branching vector*

$$\underbrace{(\omega + n, \dots, \omega + n)}_{n \text{ times}}, \omega + (1 - \omega) \cdot n$$

has a branching number not greater than  $\sqrt{3}$ .

*Proof.* For the proof we will look at the corresponding polynomial at  $\sqrt{3}$ . We define

$$g : \mathbb{R}_+^* \rightarrow \mathbb{R}, n \mapsto \sqrt{3}^{n+\omega} - \sqrt{3}^{\omega \cdot n} - n.$$

The derivative is given by  $g'(n) = \frac{\ln(3)}{2} \cdot \sqrt{3}^{n+\omega} - \frac{\ln(3)}{2} \cdot \omega \cdot \sqrt{3}^{\omega \cdot n} - 1$  for  $n \in \mathbb{R}_+^*$ . Let  $n \in [2, \infty)$ . Then  $g'(n) \geq \frac{\ln(3)}{2} \cdot \sqrt{3}^n (1 - \omega) - 1$  holds. Furthermore,  $0 \leq \frac{\ln(3)}{2} \cdot \sqrt{3}^n (1 - \omega) - 1$  holds for  $n \geq 2 \cdot \log_3 \left( \frac{2}{\ln(3) \cdot (1 - \omega)} \right)$ . Therefore,  $g$  is increasing on  $[2.6271, \infty)$ . Furthermore,  $0.0011 \leq g(1)$ ,  $0.2324 \leq g(2)$  and  $1.5483 \leq g(3)$  hold. Thus, the branching number is smaller than or equal to  $\sqrt{3}$ .  $\square$

**Theorem 4.** *All minimal rdf of an interval graph of order  $n$  can be enumerated in time  $\mathcal{O}^*(\sqrt{3}^n)$ , with polynomial delay and in polynomial space.*

*Proof.* We get the branching numbers collected in Table 2. Therefore, we only need to show that the branching is a complete case distinction. Trivially, this holds if the vertices of  $\overline{V}_2 \cup \overline{V}_1$  can only appear in the neighborhood of the leftmost vertex of  $A \cup \overline{V}_1 \cup \overline{V}_2$ . We will prove this by induction on the number of used branching rules. Since at the beginning each vertex is in  $A$ , this is settled.

Assume that we are at some point of the algorithm and that each vertex of  $\overline{V}_2 \cup \overline{V}_1$  only appears in the neighborhood of the leftmost vertex of  $A \cup \overline{V}_1 \cup \overline{V}_2$ . By induction, this also implies that each branching rule is sound at this moment (\*) (this is only important for the proof of Lemma 2). If we add a vertex  $v$  to  $V_2$ , each vertex  $w$  with  $r_w < r_v$  is either in  $V_2$  or  $\widehat{V}_2 \setminus \overline{V}_2$  and the vertices with  $l_w < r_v$  could also be in  $\overline{V}_1$ . After such a case, if the vertex  $u$  leftmost in  $A \cup \overline{V}_1 \cup \overline{V}_2$  is not in  $\overline{V}_1$ ,  $I_u \subseteq I_w$  holds for each  $\overline{V}_1$ . If we put no vertex in  $V_2$ , we put either the a part of the neighborhood of the leftmost vertex in  $\widehat{V}_2$  (works analogously to  $\overline{V}_1$  before or does not change anything). Therefore, vertices in  $\overline{V}_2 \cup \overline{V}_1$  can only appear in the neighborhood of the leftmost vertex of  $A \cup \overline{V}_1 \cup \overline{V}_2$ .  $\square$

Notice that this result is optimal, as there are interval graphs that have  $\sqrt{3}^n$  many minimal rdf, namely collections of paths.

rule	branch. vector	branch. number
1 & 2	$(1, 1 + \omega)$	1.7314
3	$(3, 1 - \omega)$	1.6992
4	$(2 + \omega, 2 + \omega, 2 - \omega)$	1.6829
5	$(4 - 2\omega, 1 - \omega)$	1.7274
6	$(3 - \omega, 2 - \omega, 4, 4)$	1.6877
7	$(3 - \omega, 2 - \omega, 3, 5 - \omega)$	1.7315
8	$(\underbrace{\omega +  N(v) \cap A , \dots, \omega +  N(v) \cap A }_{ N(v) \cap A  \text{ many times}}, \omega + (1 - \omega) \cdot  N(v) \cap A )$	$\leq \sqrt{3} \leq 1.7321$

Table 2: Branching scenarios on interval graphs

## 7 The Number of Minimal Roman Dominating Functions on Forests

Recall that a *forest* is just a different name for an acyclic graph. The main part of this section is dedicated to the proof of the following theorem.

**Theorem 5.** *A forest of order  $n$  has at most  $\sqrt{3}^n$  many minimal rdf. They can be also enumerated in this time, with polynomial delay and in polynomial space.*

Notice that this result is optimal, as there are forests that have  $\sqrt{3}^n$  many minimal rdf, namely collections of paths. A similar optimality result was rather recently obtained by Günter Rote [60] for enumerating minimal dominating sets in forests: there are (at most)  $\sqrt[13]{95}^n$  many of them in forests of order  $n$ . We will prove our result by the construction of a branching algorithm. Let  $G = (V, E)$  be a forest. As in section 6, our algorithm will partition the vertex set into  $V_2$  and  $\widehat{V}_2$ . Therefore, we will use the sets  $\widehat{A}, V_2, \widehat{V}_2, \overline{V}_2$ , where  $\widehat{A}$  (represented by a  $\ominus$  in the pictures) is the union of  $A$  and  $\overline{V}_1$  to save cases (the remaining sets have the same definitions). Again, we have  $\omega_1 = 1$  and  $\omega_2 = \omega = 0.57$ . The measure is hence given by  $|\widehat{A}| + \omega |\overline{V}_2|$ . Because of the construction, we can make use of Reduction Rule 4 first. Then, the branching rules are applied, which are sometimes distinctively more complicated than in the case of interval graphs. The set  $L = L(G[\widehat{A} \cup \overline{V}_2])$  denotes the leaves (vertices of degree 1) of the forest  $G[\widehat{A} \cup \overline{V}_2]$ .

**Branching Rule 9** *Let  $v \in \overline{V}_2 \cap L$  with  $u \in \widehat{A} \cap N(v)$ . Branch as follows:*

1. Put  $u$  in  $V_2$ .
2. Put  $u$  in  $\widehat{V}_2$ .

**Lemma 11.** *The branching is a complete case distinction. Moreover, it leads to a branching vector not worse than  $(1 + \omega, 1)$ .*

*Proof.* It is clear that this is a complete case distinction. In the first case,  $u$  goes from  $\widehat{A}$  to  $V_2$  and  $v$  has a neighbor in  $V_2$ . Thus,  $v \in \widehat{V}_2 \setminus \overline{V}_2$ . Hence, the measure decreases by  $1 + \omega$ .



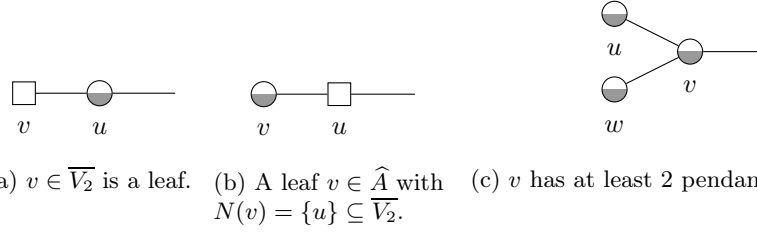

Figure 7: Illustrating Branching Rules 9, 10 and 11

In the second case,  $u \in \widehat{V_2}$  and has no neighbor in  $\widehat{A}$ . Thus,  $v$  has no neighbor in  $\widehat{A}$  anymore. This decreases the measure by 1.  $\square$

**Branching Rule 10** Let  $v \in \overline{V_2}$  such that there exists a  $u \in \widehat{A} \cap N(v) \cap L$ . Branch as follows:

1. Put  $u$  in  $V_2$ .
2. Put  $u$  in  $\widehat{V_2}$ .

**Lemma 12.** The branching is a complete case distinction. Moreover, it leads to a branching vector not worse than  $(1 + \omega, 1)$ .

*Proof.* It is clear that this is a complete case distinction. In the first case,  $u$  goes from  $\widehat{A}$  to  $V_2$  and  $v$  has a neighbor in  $V_2$ . Thus,  $v \in \widehat{V_2} \setminus \overline{V_2}$ . Hence the measure decreases by  $1 + \omega$ .

In the second case,  $u \in \widehat{V_2}$  (the measure decreases by  $1 - \omega$ ). Hence  $u \in \widehat{V_2} \setminus \overline{V_2}$  (the measure decreases by 1).  $\square$

**Branching Rule 11** Let  $v \in \widehat{A}$  with  $\{u, w\} \subseteq N(v) \cap \widehat{A} \cap L$  and  $u \neq w$ . Branch as follows:

1. Put  $u$  in  $V_2$  and  $v, w$  in  $\widehat{V_2}$ .
2. Put  $w$  in  $V_2$  and  $u, v$  in  $\widehat{V_2}$ .
3. Put  $v$  in  $V_2$  and  $u, w$  in  $\widehat{V_2}$ .
4. Put  $u, v, w$  in  $\widehat{V_2}$ .

**Lemma 13.** The branching is a complete case distinction. Moreover, it leads to a branching vector not worse than  $(3, 3, 3, 3 - \omega)$ .

*Proof.* If  $v \in V_2$  holds, Reduction Rule 4 would put both  $u$  and  $w$  into  $\widehat{V_2} \setminus \overline{V_2}$ . Since  $v, u, w$  were in  $\widehat{A}$  before, this would reduce the measure by 3. Assume there exists a minimal rdf  $f \in \{0, 1, 2\}^V$  with  $V_2(f) \setminus \widehat{A} = V_2$  and  $f(u) = f(w) = 2$ . This would contradict Theorem 1, since  $v$  is the only possible private neighbor of  $u$  and  $w$ . Therefore, at most one of  $u$  and  $w$  can have the value 2. If one is in  $V_2$ , the other one is in  $\widehat{V_2} \setminus \overline{V_2}$ . Hence, in both cases the measure decreases by 3. The last case ( $u, v, w \in \widehat{V_2}$ ) decreases the measure by  $3 - \omega$ , since  $u, w$  have no neighbor in  $\widehat{A}$ .  $\square$



(a)  $w, u \in \widehat{A}$  and  $v \in \overline{V_2}$  build a path where  $w$  is a leaf. (b)  $u, w, v \in \widehat{A}$  are a path where  $w$  is a leaf and  $v$  has a leaf as neighbor in  $\widehat{A}$ .

Figure 8: Picturing Branching Rules 12 and 13

From now on, we can assume that there exists no  $v \in \widehat{A} \cup \overline{V_2}$  with  $|N(v) \cap L \cap (\widehat{A} \cup \overline{V_2})| > 1$ .

**Branching Rule 12** Let  $v \in \overline{V_2}$  with  $u \in N(v) \cap \widehat{A}$ ,  $\{w\} = N(u) \cap L$  and  $|N(u) \cap (\widehat{A} \cup \overline{V_2})| = 2$ . Branch as follows:

1. Put  $u$  in  $V_2$  and  $w$  in  $\widehat{V_2}$ .
2. Put  $w$  in  $V_2$  and  $u$  in  $\widehat{V_2}$ .
3. Put  $u, w$  in  $\widehat{V_2}$ .

**Lemma 14.** The branching is a complete case distinction. Moreover, it leads to a branching vector not worse than  $(2 + \omega, 2, 2)$ .

*Proof.* By Reduction Rule 4, we know: If  $u \in V_2$ ,  $w$  has to be in  $\widehat{V_2} \setminus \overline{V_2}$ . Therefore, this is a complete case distinction. If  $u \in V_2$ , then  $w, v \in \widehat{V_2} \setminus \overline{V_2}$  and the measure decreases by  $2 + \omega$ . In the second case, the measure is reduced by 2, since  $u$  is dominated by  $w$ . As  $N[\{u, w\}] \subseteq \{v, u, w\}$ ,  $u, w \in \widehat{V_2} \setminus \overline{V_2}$ , the measure decreases by 2 also in the third case.  $\square$

**Branching Rule 13** Let  $v \in \widehat{A}$  with  $u \in N(v) \cap \widehat{A}$ ,  $\{w\} = N(u) \cap L \cap \widehat{A}$ ,  $|N(u) \cap (\widehat{A} \cup \overline{V_2})| = 2$  and  $\{x\} = L \cap N(v) \cap \widehat{A}$ . Branch as follows:

1. Put  $v$  in  $V_2$  and  $w, x$  in  $\widehat{V_2}$ .
2. Put  $x$  in  $V_2$  and  $v, u$  in  $\widehat{V_2}$ .
3. Put  $v, x$  in  $\widehat{V_2}$ .

**Lemma 15.** The branching is a complete case distinction. Moreover, it leads to a branching vector not worse than  $(3 - \omega, 3 - \omega, 2 - \omega)$ .

*Proof.* By Reduction Rule 4, we know that, if  $v \in V_2$  holds, then  $x, w$  have to be in  $\widehat{V_2}$ . In this case,  $x$  is already dominated. Thus, the measure is decreased by  $3 - \omega$ . Assume there exists a minimal rdf  $f \in \{0, 1, 2\}^V$  with  $V_2(f) \setminus \widehat{A} = V_2$  and  $f(u) = f(x) = 2$ . This would contradict Theorem 1, since  $v$  is the only possible private neighbor of  $x$ . In the third case, the measure is reduced by  $2 - \omega$ , since vertex  $x$  has no longer any neighbor in  $\widehat{A}$ .  $\square$

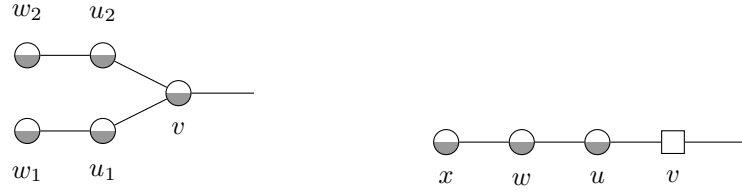

(a)  $w_i, u_i, v \in \widehat{A}$  are paths;  $w_1, w_2$  are leaves. (b)  $x, w, u \in \widehat{A}$ ,  $v \in \overline{V_2}$  form a path and  $x$  is a leaf.

Figure 9: Illustrating Branching Rules 14 and 15

Now, we present a seemingly complicated rule, but it is a rather complete branching when two paths meet in a vertex, see Figure 9a.

**Branching Rule 14** Let  $v \in \widehat{A}$  with  $u_1, u_2 \in N(v) \cap \widehat{A}$ ,  $\{w_1\} = N(u_1) \cap L \cap \widehat{A}$  and  $\{w_2\} = N(u_2) \cap L \cap \widehat{A}$ . Branch as follows:

1. Put  $v, u_1, u_2$  in  $V_2$  and  $w_1, w_2$  in  $\widehat{V_2}$ .
2. Put  $v, u_1$  in  $V_2$  and  $u_2, w_1, w_2$  in  $\widehat{V_2}$ .
3. Put  $v, u_2$  in  $V_2$  and  $u_1, w_1, w_2$  in  $\widehat{V_2}$ .
4. Put  $v$  in  $V_2$  and  $u_1, u_2, w_1, w_2$  in  $\widehat{V_2}$ .
5. Put  $u_1$  in  $V_2$  and  $v, w_1$  in  $\widehat{V_2}$ .
6. Put  $u_2, w_1$  in  $V_2$  and  $v, u_1, w_2$  in  $\widehat{V_2}$ .
7. Put  $w_2, w_1$  in  $V_2$  and  $v, u_1, u_2$  in  $\widehat{V_2}$ .
8. Put  $w_1$  in  $V_2$  and  $v, u_1, u_2, w_2$  in  $\widehat{V_2}$ .
9. Put  $u_2$  in  $V_2$  and  $v, u_1, w_1, w_2$  in  $\widehat{V_2}$ .
10. Put  $w_2$  in  $V_2$  and  $v, u_1, u_2, w_1$  in  $\widehat{V_2}$ .
11. Put  $v, u_1, u_2, w_1, w_2$  in  $\widehat{V_2}$ .

**Lemma 16.** The branching is a complete case distinction. Moreover, it leads to a branching vector not worse than  $(5, 5, 5, 5, 3, 5, 5 - \omega, 5 - \omega, 5, 5 - \omega, 5 - \omega)$ .

*Proof.* By Reduction Rule 4,  $w_1, w_2$  have to be in  $\widehat{V_2}$ , if  $v \in V_2$  holds. Therefore, the first four cases are a complete case distinction for  $v \in V_2$ . In all these cases, no vertex is in  $\overline{V_2}$ . Thus, the measure is decreased by 5 in each case.

For the remaining 7 cases, we assume  $v \in \widehat{V_2}$ . This implies that  $v, u_1, w_1$  fulfills the requirement of Branching Rule 12. This implies the branching vector  $(5, 5, 5, 5, 3, 3 - \omega, 3 - \omega)$ . For the last 2 cases of this branching vector,  $v \in \overline{V_2}$  holds. Hence, we can use again Branching Rule 12. This implies the branching vector  $(5, 5, 5, 5, 3, 5, 5 - \omega, 5 - \omega, 5, 5 - \omega, 5 - \omega)$ .  $\square$

**Branching Rule 15** Let  $v \in \overline{V_2}$  with  $u \in N(v) \cap \widehat{A}$ ,  $\{w, v\} = N(u)$ ,  $\{x\} = N(w) \cap L$  and  $|N(w) \cap (\widehat{A} \cup \overline{V_2})| = 2$ . Branch as follows:

1. Put  $u$  in  $V_2$  and  $x$  in  $\widehat{V}_2$ .
2. Put  $w$  in  $V_2$  and  $u, x$  in  $\widehat{V}_2$ .
3. Put  $u, w$  in  $\widehat{V}_2$ .

**Lemma 17.** *The branching is a complete case distinction. Moreover, it leads to a branching vector not worse than  $(2, 3, 2 - \omega)$ .*

*Proof.* By Reduction Rule 4,  $x$  has to be in  $\widehat{V}_2$ , if  $u$  or  $w$  are in  $V_2$  holds. With this information, this becomes a asymmetric branching on  $u, w$ . Therefore this is a complete case distinction. In the first case,  $v$  is dominated by  $u$ . This implies that the measure decreases by 2.

In the second case,  $u$  and  $x$  are dominated by  $w$ . Hence,  $\mu$  is reduced by 3. For the last case,  $u$  is in  $\widehat{V}_2 \setminus \overline{V}_2$ , as it has no neighbor in  $\widehat{A}$ . This reduces the measure by  $2 - \omega$ .  $\square$

**Branching Rule 16** *Let  $v \in \widehat{A}$  with  $y \in N(v) \cap L$ ,  $u \in N(v) \cap \widehat{A}$ ,  $\{w, v\} = N(u)$ ,  $\{x\} = N(w) \cap L$  and  $|N(w) \cap (\widehat{A} \cup \overline{V}_2)| = 2$ . Branch as follows:*

1. Put  $v$  in  $V_2$  and  $y$  in  $\widehat{V}_2$ .
2. Put  $u$  in  $V_2$  and  $v, x$  in  $\widehat{V}_2$ .
3. Put  $w$  in  $V_2$  and  $v, u, x$  in  $\widehat{V}_2$ .
4. Put  $x$  in  $V_2$  and  $v, u, w$  in  $\widehat{V}_2$ .
5. Put  $v, u, w, x$  in  $\widehat{V}_2$ .

**Lemma 18.** *The branching is a complete case distinction. Moreover, it leads to a branching vector not worse than  $(2, 4 - \omega, 4 - \omega, 4 - \omega, 4 - \omega)$ .*

*Proof.* By Reduction Rule 4, if  $v \in V_2$ , then  $y$  can not have the value 2. Furthermore,  $y$  is dominated and in  $\widehat{V}_2 \setminus \overline{V}_2$ . This decreases the measure by 2. For the remaining proof, we assume  $v \in \widehat{V}_2$ . If  $u \in V_2$ , then we can use Reduction Rule 4 on  $x$  and  $y$ . In this case  $y$  has no neighbor in  $\widehat{A}$  and is in  $\widehat{V}_2 \setminus \overline{V}_2$ . This reduces the measure by  $4 - \omega$ . For  $v, u \in \widehat{V}_2$ , we can use Branching Rule 12. In this case, the branching vector better than in the other uses of Branching Rule 12, since  $u$  has no neighbor in  $\widehat{A}$  after using this branch. Thus, in each of the three cases, the measure is decreasing by  $4 - \omega$ .  $\square$

**Branching Rule 17** *Let  $v \in \widehat{A}$  with  $u, y \in N(v) \cap \widehat{A}$ ,  $\{w, v\} = N(u)$ ,  $\{x\} = N(w) \cap L$ ,  $z \in N(y) \cap L$  and  $|N(w) \cap (\widehat{A} \cup \overline{V}_2)| = 2 = |N(y) \cap (\widehat{A} \cup \overline{V}_2)|$ . Branch as follows:*

1. Put  $v, u$  in  $V_2$  and  $w, x, z$  in  $\widehat{V}_2$ .
2. Put  $v, y$  in  $V_2$  and  $u, z$  in  $\widehat{V}_2$ .
3. Put  $v$  in  $V_2$  and  $u, y, z$  in  $\widehat{V}_2$ .
4. Put  $u, w$  in  $V_2$  and  $v, x, y$  in  $\widehat{V}_2$ .
5. Put  $u$  in  $V_2$  and  $v, w, x$  in  $\widehat{V}_2$ .
6. Put  $w$  in  $V_2$  and  $v, u, x$  in  $\widehat{V}_2$ .

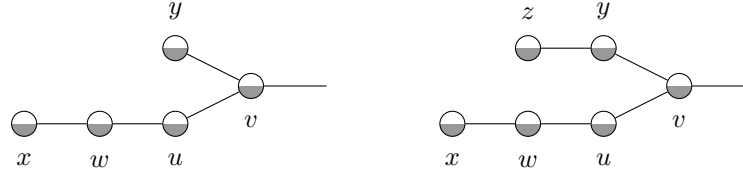

(a)  $x, w, u, v \in \widehat{A}$  induce a path and  $v$  has a neighbor of degree one. (b)  $x, w, u, v \in \widehat{A}$  and  $z, y, v \in A$  are paths, where  $z, x$  are leaves.

Figure 10: Branching Rules 16 and 17

7. Put  $x$  in  $V_2$  and  $v, u, w$  in  $\widehat{V}_2$ .
8. Put  $v, u, w, x$  in  $\widehat{V}_2$ .

**Lemma 19.** *The branching is a complete case distinction. Moreover, it leads to a branching vector not worse than  $(5 - \omega, 4, 4, 5 - \omega, 4, 4 - \omega, 4 - \omega, 4 - \omega)$ .*

*Proof.* Let  $f \in \{0, 1, 2\}^V$  be a minimal rdf with  $V_2(f) \cap (V_2 \cup \widehat{V}_2) = V_2$ . Assume  $f(v) = f(u) = 2$ . By Theorem 1,  $w$  has to be the private neighbor of  $u$  and to neither  $f(w)$  nor  $f(x)$ , we can assign 2. Reduction Rule 4 implies  $f(z) \neq 2$  for each minimal rdf with  $V_2(f) \cap (V_2 \cup \widehat{V}_2) = V_2$  and  $f(v) = 2$ . Therefore, the first three branches are a complete case distinction for  $v \in V_2$ . For the remaining branches, we assume  $f(v) \neq 2$ . If  $f(u) = f(w) = 2$  holds,  $x$  has to be a private neighbor of  $w$  and  $v$  has to be a private neighbor of  $u$ . This implies  $x, y, v \in \widehat{V}_2(f)$ . By Reduction Rule 4, the branches 4 and 5 are a complete case distinction for  $v \in \widehat{V}_2$  and  $u \in V_2$ . The remaining 3 branches are induced by  $v, u \in \widehat{V}_2$  and Branching Rule 12. After this branch,  $u$  has no neighbor in  $\widehat{A}$  anymore. Hence, in all of these 3 branches, the measure is decreased by  $4 - \omega$ .

In the first case, each vertex gets into  $V_2 \cup (\widehat{V}_2 \setminus \overline{V}_2)$ , except  $z$ . Therefore, the measure is decreased by  $5 - \omega$ . In the second case, each new vertex in  $\widehat{V}_2$  is dominated. Thus, the measure is reduced by 4. In the third branch,  $z$  has no neighbor in  $\widehat{A}$ . This implies that  $\mu$  is decreased by 4. In the fourth case each new vertex in  $\widehat{V}_2$  is dominated except  $y$ . This implies that the measure is decreased by  $5 - \omega$ . In the fifth branch, the measure is reduced by 4, as all new vertices in  $\widehat{V}_2$  are dominated except  $x$ , which has no neighbor in  $\widehat{A}$  anymore.  $\square$

**Branching Rule 18** *Let  $v \in \widehat{A}$  with  $u_1, u_2 \in N(v) \cap \widehat{A}$ ,  $\{w_i, v_i\} = N(u_i)$ ,  $\{x_i\} = N(w_i) \cap L$ , and  $|N(w_i) \cap (\widehat{A} \cup \overline{V}_2)| = 2$  for  $i \in \{1, 2\}$ . Branch as follows:*

1. Put  $u_1, u_2$  in  $V_2$  and  $w_1, w_2, x_1, x_2$  in  $\widehat{V}_2$ .
2. Put  $u_1, w_1$  in  $V_2$  and  $v, u_2, x_1$  in  $\widehat{V}_2$ .
3. Put  $u_1$  in  $V_2$  and  $u_2, w_1, x_1$  in  $\widehat{V}_2$ .
4. Put  $w_1$  in  $V_2$  and  $u_1, x_1$  in  $\widehat{V}_2$ .
5. Put  $x_1$  in  $V_2$  and  $u_1, w_1$  in  $\widehat{V}_2$ .

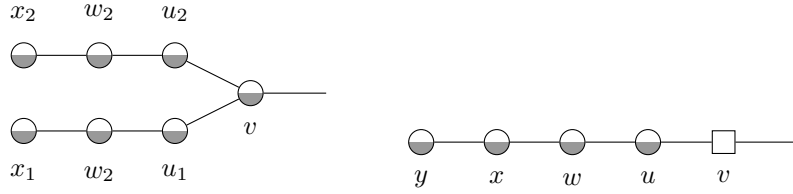

(a)  $x_i, w_i, u_i, v \in \widehat{A}$  are paths, where  $x_1, x_2$  are leaves. (b)  $y, x, w, u \in \widehat{A}, v \in \overline{V_2}$  is a path and  $y$  is a leaf.

Figure 11: Branching Rules 18 and 19

6. Put  $u_1, w_1, x_1$  in  $\widehat{V_2}$ .

**Lemma 20.** *The branching is a complete case distinction. Moreover, it leads to a branching vector not worse than  $(6, 5 - \omega, 4 - \omega, 3, 3 - \omega, 3 - \omega)$ .*

*Proof.* Let  $f \in \{0, 1, 2\}^V$  be a minimal rdf with  $V_2(f) \cap (V_2 \cup \widehat{V_2}) = V_2$ . If  $f(u_1) = f(u_2) = 2$  holds,  $u_1$  and  $u_2$  need a private neighbor. The only possibilities are  $w_1, w_2$ . Therefore, for each  $t \in N[\{w_1, w_2\}] \setminus \{u_1, u_2\} = \{w_1, w_2, x_1, x_2\}$ ,  $f(t) \neq 2$  holds. By construction,  $w_1, w_2, x_1, x_2$  would be in  $\widehat{V_2} \setminus \overline{V_2}$ . This reduces the measure by 6.

If  $f(u_1) = f(w_1) = 2 \neq f(u_2)$  holds,  $v$  is the only possible private neighbor of  $u_1$  and  $x_1$  the only one for  $w_1$ . This implies  $f(v) = f(x_1) = 0$ . Thus, the measure is decreased by  $5 - \omega$ .

Assume  $f(u_1) = 2 \neq f(u_2)$  and  $f(w_1) = 0$  (this holds since it is a neighbor of  $u_1$ ). In this case,  $f(x_1) \neq 2$ , as  $x_1$  has no private neighbor. Furthermore, all neighbors of  $x_1$  are now decided. Hence, the measure is decreased by  $4 - \omega$ .

For the last three cases, we assume  $u_1 \in \widehat{V_2}$  and use Branching Rule 12.  $\square$

**Branching Rule 19** *Let  $v \in \overline{V_2}$  with  $u \in N(v) \cap \widehat{A}$ ,  $\{w, v\} = N(u)$ ,  $\{x, u\} = N(w)$ ,  $\{y\} = N(x) \cap L$  and  $|N(x) \cap (\widehat{A} \cup \overline{V_2})| = 2$ . Branch as follows:*

1. Put  $u, w$  in  $V_2$  and  $x, y$  in  $\widehat{V_2}$ .
2. Put  $u$  in  $V_2$  and  $w$  in  $\widehat{V_2}$ .
3. Put  $w, x$  in  $V_2$  and  $u, y$  in  $\widehat{V_2}$ .
4. Put  $w$  in  $V_2$  and  $u, x, y$  in  $\widehat{V_2}$ .
5. Put  $x$  in  $V_2$  and  $u, w, y$  in  $\widehat{V_2}$ .
6. Put  $u, w, x$  in  $\widehat{V_2}$ .

**Lemma 21.** *The branching is a complete case distinction. Moreover, it leads to a branching vector not worse than  $(4 + \omega, 2 + \omega, 4, 4, 4, 3 - \omega)$ .*

*Proof.* Let  $f \in \{0, 1, 2\}^V$  be a minimal rdf with  $V_2(f) \cap (V_2 \cup \widehat{V_2}) = V_2$ . If  $f(u) = f(w) = 2$  holds,  $x$  has to be a private neighbor of  $w$ . Therefore,  $f(x) \neq 2$

and  $f(y) \neq 2$  hold. This reduces the measure by  $4 + \omega$ , since  $y$  has no neighbor in  $\widehat{A}$  and  $v, x$  are dominated.

For  $f(u) = 2 \neq f(w)$ , the measure decreases by  $2 + \omega$ , as  $v, w$  are dominated by  $u$ .

For the remaining proof, we assume  $f(u) \neq 2$ .  $f(w) = 2$  implies  $f(y) \neq 2$ , as  $y$  would not have a private neighbor. Thus, the measure is decreased by 4 in the branches 3 and 4, as  $y$  has no neighbor in  $\widehat{A}$ . For  $f(u) \neq 2$ ,  $f(w) \neq 2$  and  $f(x) = 2$ ,  $f(y) = 0$  must hold. Since  $u, w, y$  have no neighbor in  $\widehat{A}$ ,  $\mu$  is reduced by 4. In the remaining case  $u, w$  do not have any neighbor in  $\widehat{A}$ . Therefore, the measure is decreased by  $3 - \omega$ .  $\square$

**Branching Rule 20** *Let  $v \in \widehat{A}$  with  $u \in N(v) \cap \widehat{A}$ ,  $\{w, v\} = N(u)$ ,  $\{x, u\} = N(w)$ ,  $\{y\} = N(x) \cap L$  and  $|N(x) \cap (\widehat{A} \cup \overline{V}_2)| = 2$ . Branch as follows:*

1. Put  $y$  in  $V_2$  and  $x, w$  in  $\widehat{V}_2$ .
2. Put  $y, x$  in  $\widehat{V}_2$ .
3. Put  $x$  in  $V_2$  and  $y, w$  in  $\widehat{V}_2$ .
4. Put  $x, w$  in  $V_2$  and  $y, u, v$  in  $\widehat{V}_2$ .

**Lemma 22.** *The branching is a complete case distinction. Moreover, it leads to a branching vector not worse than  $(3 - \omega, 2 - \omega, 3, 5 - \omega)$ .*

The proof is a special case of the proof of Lemma 8 and hence omitted.

Rule	branching vector	branching number
9 & 10	$(1 + \omega, 1)$	1.7314
11	$(3, 3, 3, 3 - \omega)$	1.6288
12	$(2, 2, 2 + \omega)$	1.6582
13	$(3 - \omega, 3 - \omega, 2 - \omega)$	1.7164
14	$(5, 5, 5, 5, 3, 5, 5 - \omega, 5 - \omega, 5, 5 - \omega, 5 - \omega)$	1.7029
15	$(2, 3, 2 - \omega)$	1.7156
16	$(2, 4 - \omega, 4 - \omega, 4 - \omega, 4 - \omega)$	1.6966
17	$(5 - \omega, 4, 4, 5 - \omega, 4, 4 - \omega, 4 - \omega, 4 - \omega)$	1.7158
18	$(6, 5 - \omega, 4 - \omega, 3, 3 - \omega, 3 - \omega)$	1.7296
19	$(4 + \omega, 2 + \omega, 4, 4, 4, 3 - \omega)$	1.7275
20	$(3 - \omega, 2 - \omega, 3, 5 - \omega)$	1.7315

Table 3: Branching vectors and numbers for enumerating minimal rdf in forests.

## 8 Enumerating Minimal RDF in Chordal Graphs

Recall that a graph is *chordal* if the only induced cycles it might contain have length three. In this section, we are going to prove the following result:

**Theorem 6.** *All minimal Roman dominating functions of a chordal graph of order  $n$  can be enumerated with polynomial delay and in polynomial space in time  $\mathcal{O}(1.8940^n)$ .*

We are following the general approach sketched in section 5. For our branching scenario, we adopt as measure  $\mu = |A| + \omega_1 |\overline{V}_1| + \omega_2 |\overline{V}_2|$ . To obtain our result, we set  $\omega_1 = 0.710134$  and  $\omega_2 = 0.434799$ .

Initially all vertices are in  $A$ . Each branching rule assumes the preceding rules have been applied exhaustively and none of their conditions is applicable anymore. We first consider several branching rules that consider branching on vertices from  $A$ , not taking the special structure of chordal graphs into account.

Rule	branching vector	branching number
21	$(1 - \omega_2, 1 + 3 \min(1 - \omega_1, \omega_2))$	1.8940
22	$(1 + \omega_1 + \omega_2, 1 - \omega_2)$	1.8014
23	$(\omega_1, \omega_1 + 2\omega_2)$	1.8940
24	$(\omega_1, 2 - \omega_1 + \min(1 - \omega_1, \omega_2))$	1.8940
25 & 36	$(\omega_1, 2\omega_1 + \omega_2)$	1.7915
26	$(\omega_1 + \omega_2, \omega_1 + \omega_2)$	1.8321
27 & 34	$(1 + \omega_2, 1 + \omega_2)$	never worse than Branching Rule 26
28	$(1 + \omega_2 + \min(1 - \omega_2, \omega_1), 1)$	1.6181
29	$(2, 1 - \omega_2)$	1.8471
30	$(1 + \omega_2, 1)$	1.779
31	$(1 + \omega_1 + 2(1 - \omega_2), \omega_1)$	1.5743
32	$(1 + 2\omega_2, 1)$	never worse than Branching Rule 30
33	$(2 + \omega_2, 1 - \omega_2)$	1.7249
35	$(2 - \omega_1 + \omega_2, 2 + \omega_2, 2 - \omega_2)$	1.8005
37	$(2 - \omega_1 + \omega_2, 2 + \omega_2, 2 - \omega_2)$	same as Branching Rule 35

Table 4: Branching rules and their vectors and numbers for chordal graphs

**Branching Rule 21** *If  $v \in A$  has at least three neighbors in  $A \cup \overline{V}_2$ , then we branch as follows:*

1. Set  $f(v) = 2$ . Each neighbor  $x \in N(v) \cap A$  is added to  $\overline{V}_1$  and each element of  $N(v) \cap \overline{V}_2$  is assigned a value of zero and deleted.
2. Add  $v$  to  $\overline{V}_2$ .

**Lemma 23.** *The case distinction of Branching Rule 21 is complete. The worst-case branch vector is  $(1 - \omega_2, 1 + 3 \min(1 - \omega_1, \omega_2))$ .*

From now on, we can assume that a vertex from  $A$  of degree three has a neighbor in  $\overline{V}_1$ .





(a)  $v \in A$  has at least 3 neighbors in  $A \cup \overline{V_2}$   
 (b)  $v \in A$  has one neighbor  $w \in \overline{V_2}$  and at least one neighbor in  $\overline{V_1}$  has only further neighbor in  $\overline{V_1}$

Figure 12: Branching Rules 21 and 22

**Branching Rule 22** If  $v \in A$  has at least one neighbor  $w$  in  $\overline{V_2}$  and at least one neighbor  $u$  in  $\overline{V_1}$  such that all neighbors of  $u$  (but  $v$  and possibly  $w$ ) are in  $\overline{V_1}$ , then we branch as follows:

1. Set  $f(v) = 2$ . Then, set all neighbors of  $v$  that belong to  $\overline{V_2}$  to zero (and delete them) and set all neighbors of  $v$  that belong to  $\overline{V_1}$  whose neighbors (but  $v, w$ ) also belong to  $\overline{V_1}$  also to zero (and delete them).
2. Add  $v$  to  $\overline{V_2}$ .

**Lemma 24.** The case distinction of Branching Rule 22 is complete. The worst-case branch vector is  $(1 + \omega_1 + \omega_2, 1 - \omega_2)$ .

Knowing (by our invariants) that elements of  $\overline{V_1}$  are guaranteed to have neighbors in  $V_2$ , the next two branching rules apply to some elements of  $\overline{V_1}$ :

**Branching Rule 23** If  $v \in \overline{V_1}$  has at least two neighbors in  $\overline{V_2}$ , then we branch as follows:

1. Set  $f(v) = 2$ . Each neighbor  $x \in N(v) \cap A$  is added to  $\overline{V_1}$  and each element of  $N(v) \cap \overline{V_2}$  is assigned a value of zero and deleted.
2. Set  $f(v) = 0$ ; delete  $v$ .

**Lemma 25.** The case distinction of Branching Rule 23 is complete. The worst-case branch vector is  $(\omega_1, \omega_1 + 2\omega_2)$ .

**Branching Rule 24** If  $v \in \overline{V_1}$  has at least three neighbors in  $A \cup \overline{V_2}$  then we branch as follows:

1. Set  $f(v) = 2$ . Each neighbor  $x \in N(v) \cap A$  is added to  $\overline{V_1}$  and each element of  $N(v) \cap \overline{V_2}$  is assigned a value of zero and deleted.
2. Set  $f(v) = 0$ ; delete  $v$ .

**Lemma 26.** The case distinction of Branching Rule 24 is complete. The worst-case branch vector is  $(\omega_1, \omega_1 + \min(1 - \omega_1, \omega_2) + 2(1 - \omega_1))$ .

(a)  $v \in \overline{V}_1$  has at least 2 neighbor  $\overline{V}_2$  (b)  $v \in \overline{V}_1$  has at least 3 neighbors in  $A \cup \overline{V}_2$ 

Figure 13: Branching Rules 23 and 24

The worst case branch vector is given like this because  $v$  has at least two neighbors in  $A$  (otherwise Branching Rule 23 would be applied).

From now on, we discuss branching on simplicial vertices (or sometimes of vertices in the neighborhood of simplicial vertices).

**Observation 7** Notice that simplicial vertices in  $\overline{V}_1$  can only have neighbors in  $A \cup \overline{V}_2 \cup \overline{V}_1$ . As we already considered the case of vertices in  $\overline{V}_1$  that have at least three neighbors in  $A \cup \overline{V}_2$ , in the following branchings, we know that a vertex in  $\overline{V}_1$  has at most two neighbors in  $A \cup \overline{V}_2$ , not both of them being in  $\overline{V}_2$  due to Branching Rule 23.

**Branching Rule 25** If  $v \in \overline{V}_1$  is simplicial and of degree at least two, then we branch as follows:

1. Set  $f(v) = 2$  and assigning a value of zero to each of its neighbors, which results in deleting  $N[v]$ .
2. Set  $f(v) = 0$  and delete  $v$ .

**Lemma 27.** The case distinction of Branching Rule 25 is complete. The worst-case branch vector is  $(\omega_1, 2\omega_1 + \omega_2)$ .

The branching on simplicial vertices is always better if some neighbors are in  $A$  (instead of being in  $\overline{V}_1 \cup \overline{V}_2$ ), because (due to  $v$  being simplicial) a neighbor from  $A$  would immediately move to  $V_0$  in this branch. Hence, due to Branching Rule 24, we can assume that  $v$  has at least one neighbor in  $\overline{V}_1$ . This implies the worst case branching vector. It corresponds to the case where  $v$  is of degree two because of Branching Rule 23. More specifically,  $v$  has one neighbor in  $\overline{V}_1$  and one neighbor in  $\overline{V}_2 \cup A$  by Reduction Rule 1. Actually, in this situation, the worst case comes from a neighbor of  $v$  from  $\overline{V}_2$ .

Next we consider pendant simplicial vertices (and sometimes slightly more general situations).

**Observation 8** We first note that an isolated pair of pendant adjacent vertices, say  $v, w$ , give rise to a path, which has already been studied. However, assuming previous branching rules have resulted in such a path, the worst case here corresponds to  $v \in \overline{V}_2$  and  $w \in \overline{V}_1$ . To see this, note that when both  $v$  and  $w$  are in  $\overline{V}_2$  or both in  $\overline{V}_1$ , they would automatically be deleted by Reduction Rules 1 or 2.

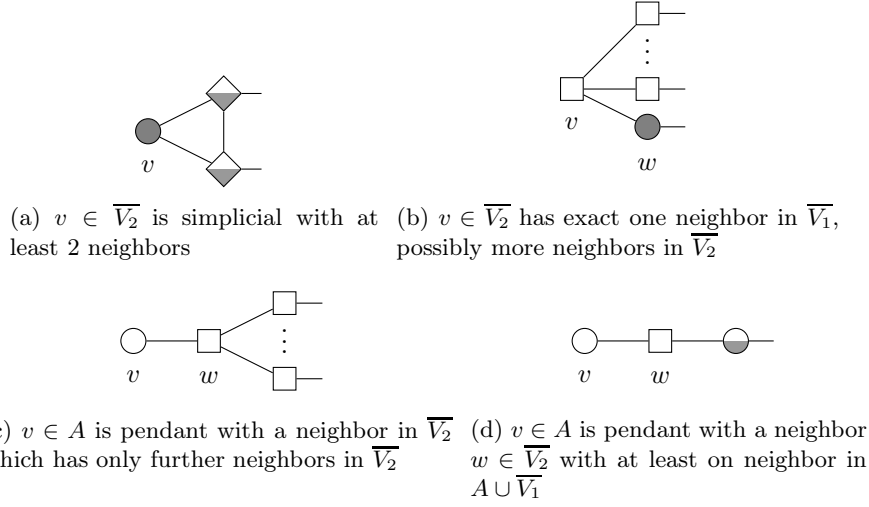

Figure 14: Branching Rules 25, 26, 27 and 28

**Branching Rule 26** If  $v \in \overline{V}_2$  is a vertex with exactly one neighbor  $w \in \overline{V}_1$  and possibly more neighbors in  $\overline{V}_2$ , then we branch as follows:

1. Set  $f(w) = 2$  and  $f(v) = 0$  (similarly, other neighbors of  $w$  are updated).
2. Set  $f(w) = 0$  and  $f(v) = 1$  (by Reduction Rule 1).

**Lemma 28.** The case distinction of Branching Rule 26 is complete. The worst-case branch vector is  $(\omega_1 + \omega_2, \omega_1 + \omega_2)$ .

Notice that this implies  $\omega_1 + \omega_2 > 1$ . Hence, Branching Rule 29 has a branching that is never better than that of Branching Rule 22.

**Branching Rule 27** If  $v \in A$  is of degree one and its neighbor  $w \in \overline{V}_2$ , and assume that all neighbors of  $w$  (but  $v$ ) are also in  $\overline{V}_2$ , then we branch as follows:

1. Set  $f(v) = 2$  and  $f(w) = 0$ .
2. Set  $f(v) = f(w) = 1$  and delete them (implicitly by Reduction Rule 1).

**Lemma 29.** The case distinction of Branching Rule 27 is complete. The worst-case branch vector is  $(1 + \omega_2, 1 + \omega_2)$ .

This branching is never worse than that of Branching Rule 26.

**Branching Rule 28** If  $v \in A$  is of degree one and its neighbor  $w \in \overline{V}_2$ , and assume that there is at least one further neighbor of  $w$  that belongs to  $A \cup \overline{V}_1$ , then we branch as follows:

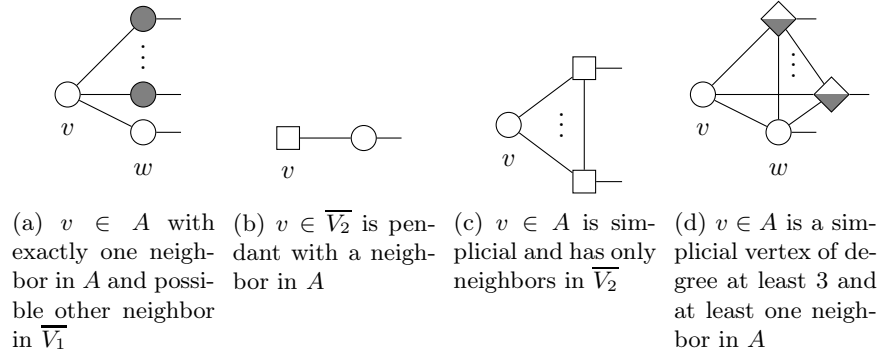

Figure 15: Branching Rules 29, 30, 32 and 33

1. Set  $f(v) = 2$  and  $f(w) = 0$  and, additionally, update all neighbors of  $w$  to  $\overline{V}_2$  or to  $V_0$ .
2. Set  $f(v) = 1$  and delete it (implicitly by Reduction Rule 1).

**Lemma 30.** *The case distinction of Branching Rule 28 is complete. The worst-case branch vector is  $(1 + \omega_2 + \min(1 - \omega_2, \omega_1), 1)$ .*

The reason for this branching vector is that one such neighbor must exist due to the previous branching rule.

The following rule again deals with a pendant vertex as a special case, but we allow some more vertices to come into the play, as it helps solve another situation turning up later.

**Branching Rule 29** *If  $v \in A$  has one neighbor  $w \in A$  and possibly other neighbors in  $\overline{V}_1$ , then we branch as follows:*

1. Set  $f(v) = 2$  and  $f(w) = 0$  (and put all further neighbors of  $w$  into  $\overline{V}_2$  or even into  $V_0$ ; then, we can delete  $v, w$ ).
2. Add  $v$  to  $\overline{V}_2$ .

**Lemma 31.** *The case distinction of Branching Rule 29 is complete. The worst-case branch vector is  $(2, 1 - \omega_2)$ .*

*Proof.* The correctness of this rule follows, because when we set  $f(v) = 2$ , then vertex  $v$  needs a private neighbor, and since all neighbors of  $v$  (if any) but  $w$  belong to  $\overline{V}_1$  by assumption,  $w$  must be the private neighbor of  $v$ , which also means that no other neighbor of  $w$  can be set to two.  $\square$

**Branching Rule 30** *If  $v \in \overline{V}_2$  is of degree one and its neighbor  $w \in A$ , then we branch as follows:*

1. Set  $f(w) = 2$  and  $f(v) = 0$  (and add all other neighbors of  $w$  to  $\overline{V}_1$  or to  $V_0$ ).
2. Add  $w$  to  $\overline{V}_2$ , set  $f(v) = 1$  and delete  $v$ .

**Branching Rule 31** *If  $v \in \overline{V}_1$  is of degree one and its neighbor  $w \in A$  with 2 neighbors in  $A$ , then we branch as follows:*

1. *Set  $f(v) = 2$  and  $f(w) = 0$  and put the neighbors of  $w$  into  $\overline{V}_2$ .*
2. *Set  $f(v) = 0$  and delete  $v$ .*

**Lemma 32.** *The case distinction of Branching Rule 31 is complete. The worst-case branch vector is  $(1 + \omega_1 + 2(1 - \omega_2), \omega_1)$ .*

**Lemma 33.** *The case distinction of Branching Rule 30 is complete. The worst-case branch vector is  $(1 + \omega_2, 1)$ .*

From this point on, every simplicial vertex of degree more than one must be in  $A \cup \overline{V}_2$ . Moreover, a simplicial vertex from  $A$  cannot have a neighbor in  $\overline{V}_1$ , otherwise either Reduction Rule 3 or Branching Rule 23 would have been applied.

**Branching Rule 32** *If  $v \in A$  is simplicial, of degree at least two such that  $N(v) \subseteq \overline{V}_2$ , then we branch as follows:*

1. *Set  $f(v) = 2$  and assign zero to all its neighbors (delete  $N[v]$ ).*
2. *Set  $f(v) = 1$  and delete it.*

**Lemma 34.** *The case distinction of Branching Rule 32 is complete. The worst-case branch vector is  $(1 + 2\omega_2, 1)$ .*

This branch is never worse than Branching Rule 30.

**Branching Rule 33** *If  $v \in A$  is simplicial, of degree at least two, with a neighbor  $w \in A$ , then we branch as follows:*

1. *Set  $f(v) = 2$  and assign zero to all its neighbors (delete  $N[v]$ ).*
2. *Add  $v$  to  $\overline{V}_2$ .*

**Lemma 35.** *The case distinction of Branching Rule 33 is complete. The worst-case branch vector is  $(2 + \omega_2, 1 - \omega_2)$ .*

Finally, we consider simplicial vertices in  $\overline{V}_2$  of degree two or more. Many cases are already dealt with. The following rules cover the remaining cases.

**Observation 9** *Let  $v \in \overline{V}_2$  be a simplicial vertex of degree two or more. Then  $v$  must have at least one neighbor  $w \in A \cup \overline{V}_1$  due to Reduction Rule 1. If  $w \in A$ , then at most one other neighbor of  $v$  can be in  $A \cup \overline{V}_2$  (by Branching Rule 21) and no other neighbor of  $v$  can be in  $\overline{V}_1$  (by Branching Rule 22). In this case, the degree of  $v$  must be exactly two. On the other hand, if  $w \in \overline{V}_1$ , then (evading the previous case)  $N(v) \subseteq \overline{V}_1$ , because if  $v$  would have any neighbors in  $\overline{V}_2$ , then Branching Rule 26 would apply.*

**Branching Rule 34** *Let  $v \in \overline{V}_2$  be a simplicial vertex of degree two with a neighbor  $w \in A$ . If the other neighbor  $w'$  of  $v$  is in  $\overline{V}_2$ , then we branch as follows:*

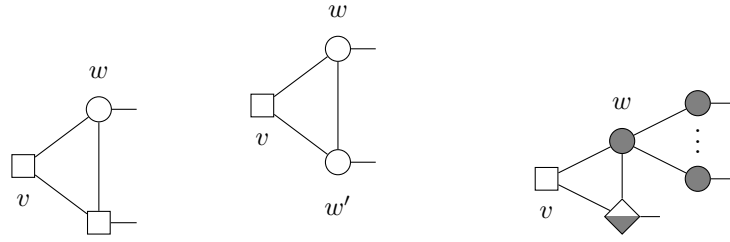

(a)  $v \in \overline{V_2}$  is a simplicial vertex with exactly 1 neighbor in  $\overline{V_2}$  and 1 in  $\overline{V_1}$  (b)  $v \in \overline{V_2}$  is a simplicial vertex with only 2 neighbors in  $A$  (c)  $v \in \overline{V_2}$  is a simplicial vertex of degree two with 1 neighbor  $w \in \overline{V_1}$  such that  $N[w] \setminus \{v\} \subseteq \overline{V_1}$

Figure 16: Branching Rules 34, 35 and 36

1. Set  $f(w) = 2$  and  $f(v) = f(w') = 0$ .
2. Add  $w$  to  $\overline{V_2}$ , set  $f(v) = 1$  and finally delete it according to Reduction Rule 1.

**Lemma 36.** *The case distinction of Branching Rule 34 is complete. The worst-case branch vector is  $(1 + 2\omega_2, 1)$ .*

Branching Rule 34 has the same branching vector as Branching Rule 32.

**Branching Rule 35** *If  $v \in \overline{V_2}$  be simplicial with two neighbors  $w, w' \in A$ , then we branch as follows:*

1. Set  $f(w) = 2$ ,  $f(v) = 0$  and add  $w'$  to  $\overline{V_1}$ .
2. Set  $f(w') = 2$  and  $f(w) = f(v) = 0$ .
3. Add  $w$  and  $w'$  to  $\overline{V_2}$  and set  $f(v) = 1$ .

**Lemma 37.** *The case distinction of Branching Rule 35 is complete. The worst-case branch vector is  $(2 - \omega_1 + \omega_2, 2 + \omega_2, 2 - \omega_2)$ .*

This branching also works if  $v, w, w'$  form a connected (triangle) component.

**Observation 10** *We now discuss a simplicial vertex  $v \in \overline{V_2}$  of degree at least two with a neighbor  $w \in \overline{V_1}$ . If  $w$  has any other neighbor  $A \in \overline{V_2}$ , then Branching Rule 23 would trigger. If  $w$  has any neighbor  $u \in A$ , then  $u$  must have at least one neighbor  $u'$  that is not in  $\overline{V_1}$  (by Reduction Rule 3). If  $u' \in \overline{V_2}$ , then Branching Rule 22 would be applicable. Hence,  $u' \in A$ , but this case is resolved by Branching Rule 29. Hence, all neighbors of  $w$  (but  $v$ ) must belong to  $\overline{V_1}$ .*

**Branching Rule 36** *If  $v \in \overline{V_2}$  is simplicial, of degree at least two, with a neighbor  $w$  such that  $N[w] \setminus \{v\} \subseteq \overline{V_1}$ , then we branch as follows:*

1. Set  $f(w) = 2$ ,  $f(v) = 0$  and delete  $N[v]$ .

2. Set  $f(w) = 0$  and delete it.

**Lemma 38.** *The case distinction of Branching Rule 36 is complete. The worst-case branch vector is  $(2\omega_1 + \omega_2, \omega_1)$ .*

In the first branch, observe that by our previous reasoning, neighbors of  $v$  are in  $\overline{V_1}$ , and do not have any more vertices to dominate. This is the same as in Branching Rule 25.

**Branching Rule 37** *If  $v \in \overline{V_2}$  is simplicial, of degree at least two, with neighbors  $w, w' \in \overline{V_1}$  such that  $N[w] \subseteq N[w']$ , then we branch as follows:*

1. Set  $f(w') = 2$ ,  $f(v) = f(w) = 0$ .
2. Set  $f(w') = 0$  and delete it.

**Lemma 39.** *The case distinction of Branching Rule 37 is complete. The worst-case branch vector is  $(2\omega_1 + \omega_2, \omega_1)$ .*

**Lemma 40.** *The Reduction and Branching Rules cover all possible cases for chordal graphs.*

*Proof.* Since each chordal graph has at least one simplicial vertex, we will show that each case for simplicial vertex  $v \in A \cup \overline{V_1} \cup \overline{V_2}$  is covered. At first let  $v \in A$ . By the branching rules 27, 28 and 29,  $v$  can not be pendant.  $N(v) \subseteq \overline{V_2}$  triggers Branching Rule 32. If  $N(v) \cap A$  is not empty it would trigger 33. The remaining cases are covered by Branching Rule 22.

A simplicial vertex  $v \in \overline{V_1}$  with degree at least 2 would trigger Branching Rule 25. A pendant  $v \in \overline{V_1}$  has to have a neighbor in  $w \in A \cup \overline{V_2}$ .  $N[w] \setminus \{v\} \subseteq \overline{V_2}$  triggers Branching Rule 26. For  $w \in A$  with  $N[w] \cap \overline{V_2} \neq \emptyset$ , we can use Branching Rule 22. Because of Reduction Rule 2 and Branching Rule 29,  $w$  needs at least 2 neighbors in  $A$ . Branching Rule 21 prevents that  $w$  has 3 neighbors in  $A$ . This triggers Branching Rule 31.

Let  $v \in \overline{V_2}$ . If  $v$  is pendant, it triggers a reduction rule, Branching Rule 26 or Branching Rule 30. If  $v$  has degree 2 and one neighbor is in  $A$ , then this triggers one of the Branching Rules 23, 34, 35 and 36. Finally, assuming we have used all branching rules exhaustively, and particularly because of Branching Rule 22, Branching Rule 23 and Branching Rule 24, no two simplicial vertices in  $\overline{V_2}$  can have a common neighbor. Therefore, at least one such simplicial vertex  $v$  must have a semi-simplicial neighbor  $w$ . In other words,  $w$  becomes simplicial after its deletion, as defined in [5]. This means  $N[w] \subset N[w']$  for each other neighbor  $w'$  of  $v$ , which justifies the branching in Branching Rule 37.  $\square$

## 9 Concluding Remarks and Suggestions for Future Research

The number of minimal Roman dominating functions in a graph of order  $n$  has been recently shown, constructively, to be in  $\mathcal{O}(1.9332^n)$  [4]. In this paper, we

consider the same enumeration problem on special graph classes, namely split graphs, cobipartite graphs, forests, interval graphs, and (general) chordal graphs.

On chordal graphs, we present an enumeration algorithm that runs in time  $\mathcal{O}(1.8940^n)$ , which gives a better upper bound on the number of minimal rdfs than in the general case. We observe that the maximum number of minimal rdfs in forests and interval graphs (and more generally chordal graphs) of order  $n$  is in  $\Omega(\sqrt{3}^n)$ . The lower bound in the case of split graphs and cobipartite graphs is shown to be in  $\Omega(\sqrt{2}^n)$ . We show that minimal rdfs can be enumerated in  $\Omega(1.7321^n)$  on forests and interval graphs, thus achieving an optimal input-sensitive enumeration in these cases. For split and cobipartite graphs our enumeration is not tight, but gives an upper bound of  $\mathcal{O}(1.4656^n)$ , which is relatively close to the lower bound.

For future work, it would be an interesting natural question to close the gap between the presented lower and upper bounds in the case of split and cobipartite graphs. Our enumeration algorithm in the case of forests was more exhaustive and more intricate than one would expect for this graph class, yet it proved to be optimal as we noted above. It would be interesting to obtain a simplified enumeration algorithm in this case.

More specifically, it remains open whether enumeration on chordal graphs can be improved further, so we hereby pose it as an open problem, or whether one can obtain a higher lower bound, which would also be a gap-improvement on general graphs. So far, the best lower bound for general graphs is a collection of  $C_5$ , which is clearly not a chordal graph. The worst-case example for chordal graphs is a collection of  $P_2$ , see section 4. Moreover, we did not see any way to improve the enumeration for bipartite graphs over the general case, which is a natural class to consider, given our results on split and on cobipartite graphs.

Generally speaking, there is also the combinatorial question of determining the number of minimal or maximal solutions for certain graph classes. While this question is generally #P-hard, also on restricted graph classes (see [45]), concrete recursive formulas are known for special graph classes as paths and cycles in the case of domination; see [14, Propos. 7] for the number of minimal dominating sets on a path, or [32] for the number of maximal independent sets on paths and cycles. More seems to be known about maximal independent sets compared to minimal dominating sets; we also refer to [19, 37, 46]. In this paper, we developed a recursive formula for the number of minimal rdf on paths, but we did not look into general counting problems with respect to minimal rdf, nor did we look at other seemingly simple graph classes. Also in this respect, many tasks remain to be executed.

Many variants of Roman domination have been proposed in the literature, for instance, regarding multi-attack variants, see [23, 34, 40, 41], multiple Roman domination [1, 2, 7, 56] or so-called Italian domination and its variants, see [22, 27, 56]. For all these variations, one could discuss the question of enumerating minimal dominating functions. This describes a vast open area of research. In particular, it would be interesting to see other problems related to Roman domination with a polynomial-time solvable extension variant.



## References

1. H. Abdollahzadeh Ahangar, M. P. Álvarez, M. Chellali, S. M. Sheikholeslami, and J. C. Valenzuela-Tripodoro. Triple Roman domination in graphs. *Applied Mathematics and Computation*, 391:125444, 2021.
2. H. Abdollahzadeh Ahangar, M. Chellali, and S. M. Sheikholeslami. On the double Roman domination in graphs. *Discrete Applied Mathematics*, 232:1–7, 2017.
3. F. N. Abu-Khzam, C. Bazgan, M. Chopin, and H. Fernau. Data reductions and combinatorial bounds for improved approximation algorithms. *Journal of Computer and System Sciences*, 82(3):503–520, 2016.
4. F. N. Abu-Khzam, H. Fernau, and K. Mann. Minimal Roman dominating functions: Extensions and enumeration. Technical Report 2204.04765, Cornell University, ArXiv/CoRR, 2022. URL: <https://doi.org/10.48550/arXiv.2204.04765>.
5. F. N. Abu-Khzam and P. Heggenes. Enumerating minimal dominating sets in chordal graphs. *Information Processing Letters*, 116(12):739–743, 2016.
6. C. Bazgan, L. Brankovic, K. Casel, H. Fernau, K. Jansen, K.-M. Klein, M. Lampis, M. Liedloff, J. Monnot, and V. Paschos. The many facets of upper domination. *Theoretical Computer Science*, 717:2–25, 2018.
7. R. A. Beeler, T. W. Haynes, and S. T. Hedetniemi. Double Roman domination. *Discrete Applied Mathematics*, 211:23–29, 2016.
8. S. Benecke. Higher order domination of graphs. Master’s thesis, Department of Applied Mathematics of the University of Stellenbosch, South Africa, <http://dip.sun.ac.za/~vuuren/Theses/Benecke.pdf>, 2004.
9. S. Bermudo and H. Fernau. Computing the differential of a graph: hardness, approximability and exact algorithms. *Discrete Applied Mathematics*, 165:69–82, 2014.
10. S. Bermudo and H. Fernau. Combinatorics for smaller kernels: The differential of a graph. *Theoretical Computer Science*, 562:330–345, 2015.
11. S. Bermudo, H. Fernau, and J. M. Sigarreta. The differential and the Roman domination number of a graph. *Applicable Analysis and Discrete Mathematics*, 8:155–171, 2014.
12. T. Bläsius, T. Friedrich, J. Lischied, K. Meeks, and M. Schirneck. Efficiently enumerating hitting sets of hypergraphs arising in data profiling. *Journal of Computer and System Sciences*, 124:192–213, 2022.
13. M. Bonamy, O. Defrain, M. Heinrich, and J.-F. Raymond. Enumerating minimal dominating sets in triangle-free graphs. In R. Niedermeier and C. Paul, editors, *36th International Symposium on Theoretical Aspects of Computer Science (STACS 2019)*, volume 126 of *LIPICs*, pages 16:1–16:12. Schloss Dagstuhl - Leibniz-Zentrum für Informatik, 2019.
14. D. Bród. On the number of minimal dominating sets in some classes of trees. *Int. J. Contemp. Math. Sciences*, 6:503–506, 2011.
15. K. Casel, H. Fernau, M. Khosravian Ghadikolaei, J. Monnot, and F. Sikora. Extension of some edge graph problems: Standard and parameterized complexity. In L. A. Gasieniec, J. Jansson, and C. Levkopoulos, editors, *Fundamentals of Computation Theory - 22nd International Symposium, FCT*, volume 11651 of *LNCS*, pages 185–200. Springer, 2019.
16. K. Casel, H. Fernau, M. Khosravian Ghadikolaei, J. Monnot, and F. Sikora. Abundant extensions. In T. Calamoneri and F. Corò, editors, *Algorithms and Complexity - 12th International Conference, CIAC*, volume 12701 of *LNCS*, pages 3–17. Springer, 2021. doi:10.1007/978-3-030-75242-2\1.

17. K. Casel, H. Fernau, M. Khosravian Ghadikolaei, J. Monnot, and F. Sikora. On the complexity of solution extension of optimization problems. *Theoretical Computer Science*, 904:48–65, 2022. doi:<https://doi.org/10.1016/j.tcs.2021.10.017>.
18. E. W. Chambers, B. Kinnersley, N. Prince, and D. B. West. Extremal problems for Roman domination. *SIAM Journal of Discrete Mathematics*, 23:1575–1586, 2009.
19. G. J. Chang and M.-J. Jou. The number of maximal independent sets in connected triangle-free graphs. *Discrete Mathematics*, 197-198:169–178, 1999.
20. M. Chapelle, M. Cochefert, J.-F. Couturier, D. Kratsch, M. Liedloff, and A. Perez. Exact algorithms for weak Roman domination. In T. Lecroq and L. Mouchard, editors, *Combinatorial Algorithms - 24th International Workshop, IWOCA*, volume 8288 of *LNCS*, pages 81–93. Springer, 2013.
21. M. Chellali, T. W. Haynes, S. M. Hedetniemi, S. T. Hedetniemi, and A. A. McRae. A Roman domination chain. *Graphs and Combinatorics*, 32(1):79–92, 2016.
22. M. Chellali, T. W. Haynes, S. T. Hedetniemi, and A. A. McRae. Roman  $\{2\}$ -domination. *Discrete Applied Mathematics*, 204:22–28, 2016.
23. E. J. Cockayne, P. J. P. Grobler, W. R. Gründlingh, J. Munganga, and J. H. van Vuuren. Protection of a graph. *Utilitas Mathematica*, 67:19–32, 2005.
24. J.-F. Couturier, P. Heggernes, P. van ’t Hof, and D. Kratsch. Minimal dominating sets in graph classes: Combinatorial bounds and enumeration. *Theoretical Computer Science*, 487:82–94, 2013.
25. J.-F. Couturier, R. Letourneur, and M. Liedloff. On the number of minimal dominating sets on some graph classes. *Theoretical Computer Science*, 562:634–642, 2015.
26. N. Creignou, M. Kröll, R. Pichler, S. Skritek, and H. Vollmer. A complexity theory for hard enumeration problems. *Discrete Applied Mathematics*, 268:191–209, 2019.
27. M. Dettlaff, M. Lemańska, and J. A. Rodríguez-Velázquez. Secure Italian domination in graphs. *Journal of Combinatorial Optimization*, 41(1):56–72, 2021.
28. P. A. Dreyer. *Applications and Variations of Domination in Graphs*. PhD thesis, Rutgers University, New Jersey, USA, PhD Thesis, 2000.
29. T. Eiter and G. Gottlob. Identifying the minimal transversals of a hypergraph and related problems. *SIAM Journal on Computing*, 24(6):1278–1304, 1995.
30. O. Favaron, H. Karami, R. Khoeilar, and S. M. Sheikholeslami. On the Roman domination number of a graph. *Discrete Mathematics*, 309(10):3447 – 3451, 2009.
31. H. Fernau. ROMAN DOMINATION: a parameterized perspective. *International Journal of Computer Mathematics*, 85:25–38, 2008.
32. Z. Füredi. The number of maximal independent sets in connected graphs. *Journal of Graph Theory*, 11(4):463–470, 1987.
33. A. Gainer-Dewar and P. Vera-Licona. The minimal hitting set generation problem: Algorithms and computation. *SIAM Journal of Discrete Mathematics*, 31(1):63–100, 2017.
34. W. Goddard, S. M. Hedetniemi, and S. T. Hedetniemi. Eternal security in graphs. *J. Combin. Math. Combin. Comput.*, 52:169–180, 2005.
35. P. A. Golovach, P. Heggernes, M. M. Kanté, D. Kratsch, and Y. Villanger. Enumerating minimal dominating sets in chordal bipartite graphs. *Discrete Applied Mathematics*, 199:30–36, 2016.
36. P. A. Golovach, P. Heggernes, and D. Kratsch. Enumerating minimal connected dominating sets in graphs of bounded chordality. *Theoretical Computer Science*, 630:63–75, 2016.
37. J. R. Griggs, C. M. Grinstead, and D. R. Guichard. The number of maximal independent sets in a connected graph. *Discrete Mathematics*, 68(2):211–220, 1988.

38. T. W. Haynes, S.T. Hedetniemi, and M. A. Henning, editors. *Topics in Domination in Graphs*, volume 64 of *Developments in Mathematics*. Springer, 2020.
39. S. T. Hedetniemi, R. R. Rubalcaba, P. J. Slater, and M. Walsh. Few compare to the great Roman empire. *Congressus Numerantium*, 217:129–136, 2013.
40. M. A. Henning. Defending the Roman Empire from multiple attacks. *Discrete Mathematics*, 271:101–115, 2003.
41. M. A. Henning and S. T. Hedetniemi. Defending the Roman empire: a new strategy. *Discrete Mathematics*, 266(1-3):239–251, 2003.
42. M. M. Kanté, V. Limouzy, A. Mary, and L. Nourine. On the enumeration of minimal dominating sets and related notions. *SIAM Journal of Discrete Mathematics*, 28(4):1916–1929, 2014.
43. M. M. Kanté, V. Limouzy, A. Mary, L. Nourine, and T. Uno. Polynomial delay algorithm for listing minimal edge dominating sets in graphs. In F. Dehne, J.-R. Sack, and U. Stege, editors, *Workshop on Algorithms and Data Structures, WADS*, volume 9214 of *LNCS*, pages 446–457. Springer, 2015.
44. M. M. Kanté, V. Limouzy, A. Mary, L. Nourine, and T. Uno. A polynomial delay algorithm for enumerating minimal dominating sets in chordal graphs. In E. W. Mayr, editor, *International Workshop on Graph-Theoretic Concepts in Computer Science, WG 2015*, volume 9224 of *LNCS*, pages 138–153. Springer, 2016.
45. M. M. Kanté and T. Uno. Counting minimal dominating sets. In T. V. Gopal, G. Jäger, and S. Steila, editors, *Theory and Applications of Models of Computation - 14th Annual Conference, TAMC*, volume 10185 of *LNCS*, pages 333–347, 2017.
46. K. M. Koh, C. Y. Goh, and F. M. Dong. The maximum number of maximal independent sets in unicyclic connected graphs. *Discrete Mathematics*, 308(17):3761–3769, 2008.
47. T. Kraner Šumenjak, P. Pavlič, and A. Tepeh. On the Roman domination in the lexicographic product of graphs. *Discrete Applied Mathematics*, 160(13-14):2030–2036, 2012.
48. M. Liedloff. *Algorithmes exacts et exponentiels pour les problèmes NP-difficiles: domination, variantes et généralisations*. PhD thesis, Université Paul Verlaine - Metz, France, 2007.
49. M. Liedloff, T. Kloks, J. Liu, and S.-L. Peng. Efficient algorithms for Roman domination on some classes of graphs. *Discrete Applied Mathematics*, 156(18):3400–3415, 2008.
50. C.-H. Liu and G. J. Chang. Roman domination on 2-connected graphs. *SIAM Journal of Discrete Mathematics*, 26(1):193–205, 2012.
51. C.-H. Liu and G. J. Chang. Upper bounds on Roman domination numbers of graphs. *Discrete Mathematics*, 312(7):1386–1391, 2012.
52. C.-H. Liu and G. J. Chang. Roman domination on strongly chordal graphs. *Journal of Combinatorial Optimization*, 26(3):608–619, 2013.
53. A. Mary. *Énumération des dominants minimaux d'un graphe*. PhD thesis, LIMOS, Université Blaise Pascal, Clermont-Ferrand, France, November 2013.
54. J. L. Mashburn, T. W. Haynes, S. M. Hedetniemi, S. T. Hedetniemi, and P. J. Slater. Differentials in graphs. *Utilitas Mathematica*, 69:43–54, 2006.
55. B. P. Mobaraky and S. M. Sheikholeslami. Bounds on Roman domination numbers of graphs. *Matematichki Vesnik*, 60:247–253, 2008.
56. D. A. Mojdeh and L. Volkmann. Roman  $\{3\}$ -domination (double Italian domination). *Discrete Applied Mathematics*, 283:555–564, 2020.
57. A. Pagourtzis, P. Penna, K. Schlude, K. Steinhöfel, D. S. Taylor, and P. Widmayer. Server placements, Roman domination and other dominating set variants.

- In R. A. Baeza-Yates, U. Montanari, and N. Santoro, editors, *Foundations of Information Technology in the Era of Networking and Mobile Computing, IFIP 17<sup>th</sup> World Computer Congress — TC1 Stream / 2<sup>nd</sup> IFIP International Conference on Theoretical Computer Science IFIP TCS*, pages 280–291. Kluwer, 2002. Also available as Technical Report 365, ETH Zürich, Institute of Theoretical Computer Science, 10/2001.
58. S.-L. Peng and Y.-H. Tsai. Roman domination on graphs of bounded treewidth. In *The 24th Workshop on Combinatorial Mathematics and Computation Theory*, pages 128–131, 2007.
  59. C. S. ReVelle and K. E. Rosing. Defendens imperium Romanum: A classical problem in military strategy. *American Mathematical Monthly*, 107:585–594, 2000. <http://www.jhu.edu/~jhumag/0497web/locate3.html>.
  60. G. Rote. The maximum number of minimal dominating sets in a tree. In T. M. Chan, editor, *Proceedings of the Thirtieth Annual ACM-SIAM Symposium on Discrete Algorithms*, pages 1201–1214. SIAM, 2019.
  61. W. Shang, X. Wang, and X. Hu. Roman domination and its variants in unit disk graphs. *Discrete Mathematics, Algorithms and Applications*, 2(1):99–106, 2010.
  62. Z. Shi and K. M. Koh. Counting the number of minimum Roman dominating functions of a graph. Technical report, ArXiv / CoRR, abs/1403.1019, 2014.
  63. I. Stewart. Defend the Roman Empire. *Scientific American*, pages 136,137,139, December 1999.
  64. J. M. M. van Rooij. *Exact Exponential-Time Algorithms for Domination Problems in Graphs*. PhD thesis, Universiteit Utrecht, The Netherlands, 2011.
  65. H.-M. Xing, X. Chen, and X.-G. Chen. A note on Roman domination in graphs. *Discrete Mathematics*, 306(24):3338–3340, 2006.
  66. F. Xueliang, Y. Yuansheng, and J. Baoqi. Roman domination in regular graphs. *Discrete Mathematics*, 309(6):1528–1537, 2009.
  67. I. G. Yero and J. A. Rodríguez-Velázquez. Roman domination in Cartesian product graphs and strong product graphs. *Applicable Analysis and Discrete Mathematics*, 7:262–274, 2013.