

Locating 101

A QUICK GUIDE TO UNDERGROUND LOCATING

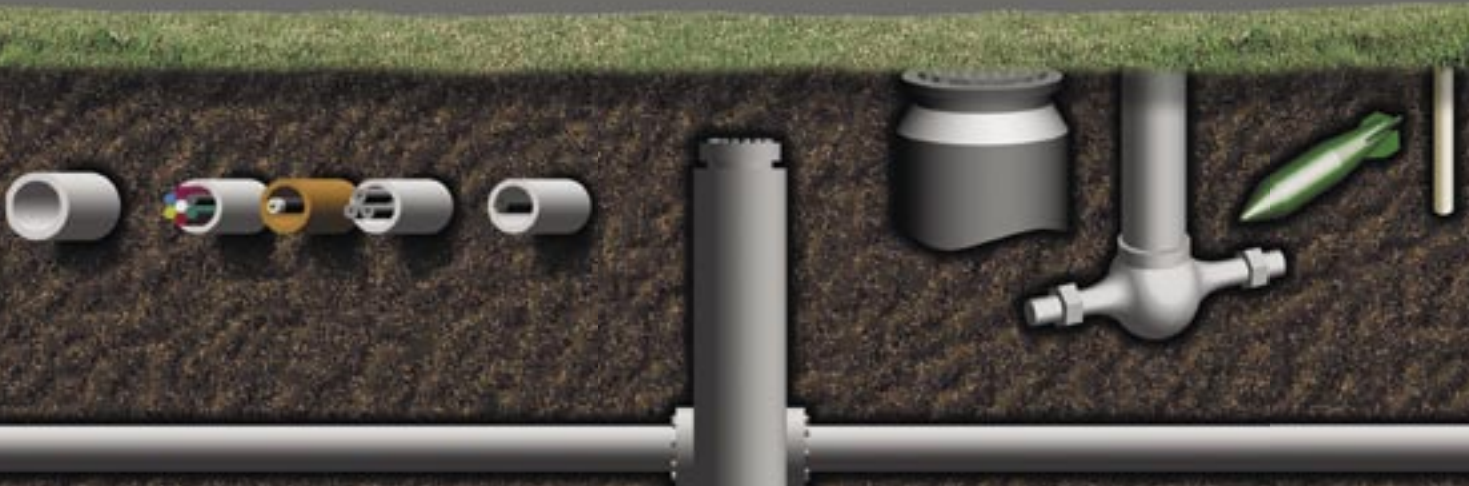

SCHONSTEDT 
INSTRUMENT COMPANY
Making Locating Easier Since 1953

**AN INTRODUCTION TO
MAGNETIC AND UTILITY
LOCATING BASICS**



Schonstedt's XTPc pipe and cable locator: transmitter, receiver (extended) and faceplate.

Schonstedt's TraceMaster pipe and cable locator: transmitter, receiver and faceplate.

TABLE OF CONTENTS

AN INTRODUCTION TO PIPE AND CABLE LOCATING BASICS

applying signal.....	4
conductive mode	5
inductive mode.....	6
inductive clamp mode	7
passive power	7
trace mode.....	8
adjusting gain.....	9
how to sweep	9
how to trace	10
milliamp display.....	10

Chapter 1: LOCATING POWER CABLE

applying signal.....	11
conductive mode	11
signal to transformer	11
signal to meter.....	12
signal to targeted cable.....	12
inductive mode.....	13
inductive clamp mode	13
signal to primary cables	14
signal to secondary cables	15
slack loops	16
open ends	16
streetlight cables	17

Chapter 2: LOCATING PIPE

applying signal.....	19
inductive mode.....	19
conductive mode	20
tracer wires.....	22
inductive clamp mode	23

Chapter 3: LOCATING TELEPHONE CABLE

introduction.....	25
applying signal.....	25
inductive mode.....	25
conductive mode	26
inductive clamp mode	27
slack loops and butt splices	30
unknown laterals	30
starting from pedestals.....	32
service drops.....	33
open ends	33
locating fiber optic	33
starting from an office	34
splice points	35
tracing fiber.....	36

Chapter 4: LOCATING CATV CABLE

applying signal.....	37
inductive mode.....	37
conductive mode	38
inductive clamp mode	39
slack loops in cable.....	40
starting from pedestals.....	40

Chapter 5: MAGNETIC LOCATING

theory	42
how to search.....	43
how to pinpoint.....	43
sensitivity adjustment.....	44
strongly magnetized markers...	44
chain link fences.....	45
metallic pipe location	46
cluttered areas	47
things to remember.....	47

AN INTRODUCTION TO PIPE AND CABLE LOCATING BASICS

How to apply signal:

Locating pipes and cables with utility locators is usually a matter of applying a signal to the utility with a transmitter and then detecting that signal with the receiver. Signal can be applied to utilities in three basic ways:

- conductive mode: Using the direct connect cable and supplied clips.
- inductive mode: By sitting the inductive antenna / transmitter over the intended conductor.
- inductive clamp mode: Uses a Coupler/Clamp.

Regardless of the method used, the key to getting a strong signal is applying the proper frequency. All signals applied to buried lines dissipate into the ground, which means that the signal gets weaker as it gets farther away from the transmitter. The main factors that affect signal strength are cable diameter, soil conditions and signal frequency and of these, only signal frequency is under control of the operator.

Frequencies are grouped into four classes:

Low - less than 1 kHz: Since low frequencies don't propagate to other lines readily, they are a good choice for congested areas with several overlapping utilities, and they are also good for tracing over long distances. But low frequencies can't be used with inductive or inductive clamp methods - only the conductive method works.

Medium - between 1 and 10 kHz: Medium frequencies are the most generally useful frequencies for location. Most can be applied with conductive and inductive clamp methods. They will occasionally propagate to other lines, but not so readily as higher frequencies. They don't travel as far as low frequencies, but are still useful for traces of up to a mile. Some small diameter lines, like telecom cables, may require higher frequencies for a good signal.

High - between 10 and 100 kHz: High frequencies weaken rapidly compared to lower frequencies, and they readily propagate to nearby conductors. But they're useful for small diameter cable TV and telecommunication lines. They are best applied by the inductive and inductive clamp methods. If the signal is weak near the beginning of the trace, try a higher frequency.

Very High - greater than 100 kHz: Because they attenuate very quickly compared to lower frequencies, and because they easily propagate to other conductors, Very High frequencies are a good way to rapidly sweep for all utilities in a congested area. Very High frequencies will also give good signal across gaps in a line, such as insulated pipe joints or cable breaks.

SIGNAL APPLICATION METHODS:

Conductive: The conductive method means that a direct connection is made to the pipe or cable being located - this isolates the signal to just one line. For a strong signal over a long distance, and for minimal coupling to other conductors, low frequencies are best. Proper grounding is important when using the conductive method: in general, the better the ground, the stronger the signal. The transmitter is electrically connected at one end and the signal travels along the

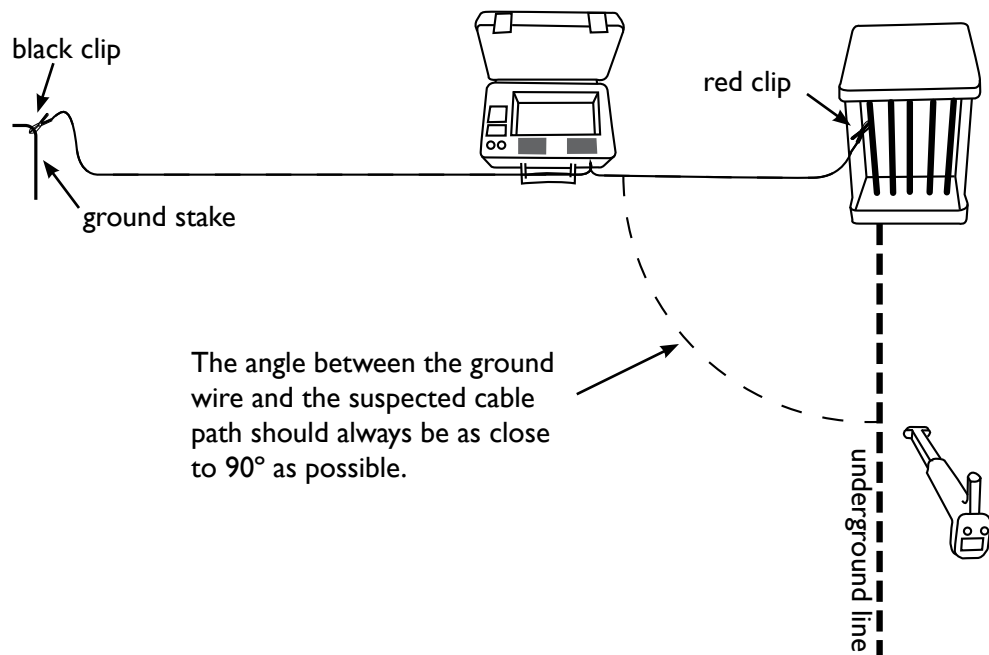

desired line, goes to ground, and completes the circuit via the ground stake. A poor connection or ground will give a weak or non-existent signal. The ground stake should be as far from the far end ground as possible, and should also be well away from the trace path. In practice, this means that extending the stake away from the probable trace path at 90° is usually the best option (see illustration). If necessary, ground leads can be extended with any insulated wire, and ground stakes can be reset after the actual trace path is discovered.

Inductive: Of the three signal application methods, the inductive method is the simplest, provided that at least one point on the trace path is known. Just place the transmitter on the ground directly over the buried pipe or cable, and line up the transmitter arrow parallel to the line direction. If the transmitter is not within five feet or so of the line, signal is likely to be very weak.

The inductive method tends not to work in situations where several conductors overlap, where the conductor being traced is not well grounded at both ends, or where the conductor is very deep. High frequencies should be used, from 33 kHz to 455 kHz, but keep in mind that the likelihood of other conductors picking up signal increases as the frequency is raised. Also, if the receiver is within 40 feet of the transmitter, it will pick up signal through the air so it is best to begin at least 40 feet away from the transmitter when tracing.

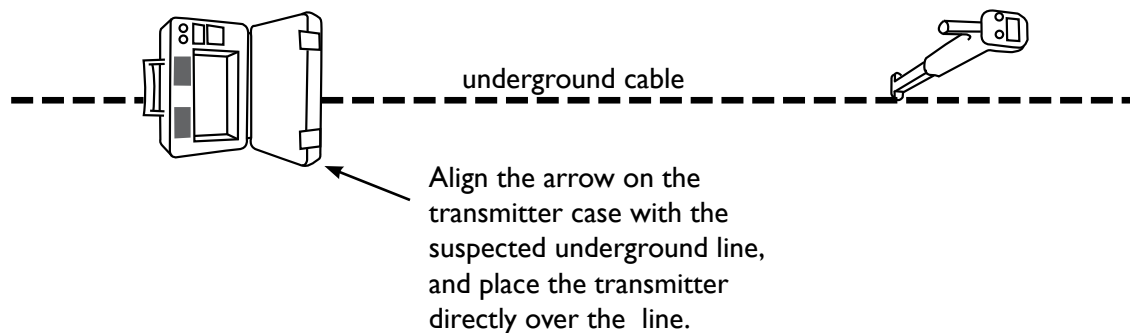

Inductive Coupler / Clamp: The third way to apply signal is with the inductive clamp method. By closing the clamp's jaws around a pipe or cable, a signal can be induced into a particular line, reducing the chance of other conductors picking up signal. The clamp must close fully, and the conductor must be well grounded on the near and as well as the far end.

This method varies in specific applications, as described elsewhere in this manual.

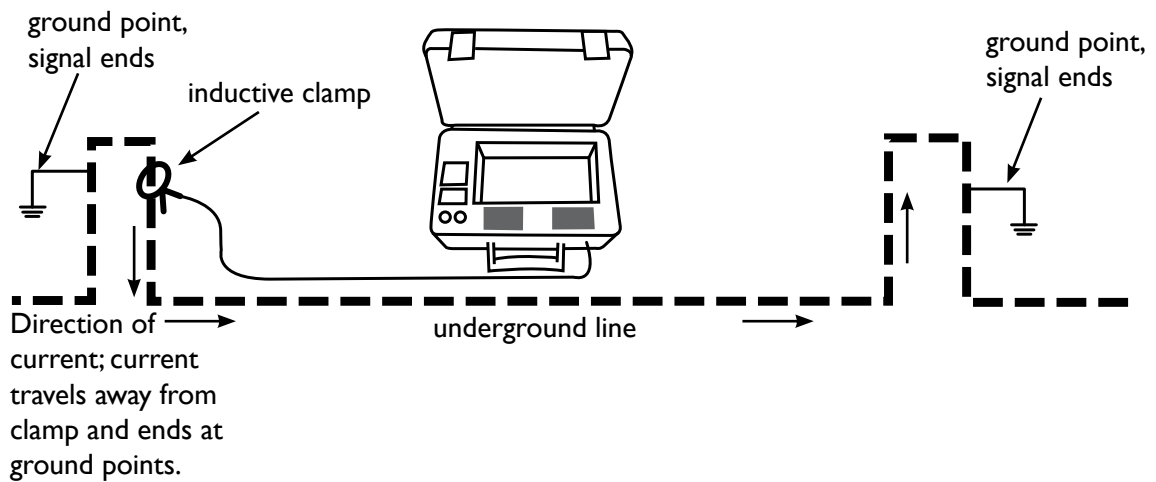

Passive Power Frequencies:

In Passive mode, the transmitter is not used. Instead, the receiver is used to search for 50 or 60 Hz signals, like those produced by energized cable carrying AC power.

These are low frequencies, but they can still propagate to other nearby conductors. In passive mode, it is not possible to distinguish between conductors - the signal could be coming from any grounded conductor, such as buried pipe or rebar. But knowing they exist can be useful.

Energized power cables are easy to detect except for those that have been designed so that the 'out' and 'return' fields cancel each other, as is typically the case with appliance power cords. Cables like this, particularly three-phase cables, are hard to detect. One trick that can help when tracing 60 Hz three-phase cables is to use the reinforcing ninth harmonic of 60 Hz, 540 Hz. Similarly, 50 Hz three phase cables

can be detected at the 11th harmonic, 550 Hz, which your receiver is factory set to detect.

Trace Mode:

Several indicators help you to zero in on pipe or cable location. The receiver tone changes pitch and is highest when directly over the traced utility. Similarly, numeric strength indicators are also at maximum directly over lines. Both these indicators rely on the receiver handle being in alignment with the cable path. If the path changes direction abruptly, display arrows can guide you back to the true path, as shown in the illustration. If no arrow elements display, then signal strength is too weak for detection and you will have to search using the receiver tone and numeric indicators - you may also have to try twisting the receiver to align the handle with the cable path. Please note, directional indication is not available at 455 kHz.

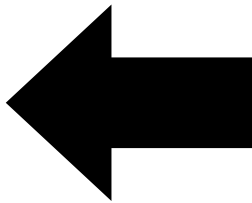

Left Arrow: Move receiver to the left to get back on trace path.

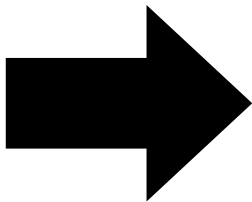

Right Arrow: Move receiver to the right to get back on trace path.

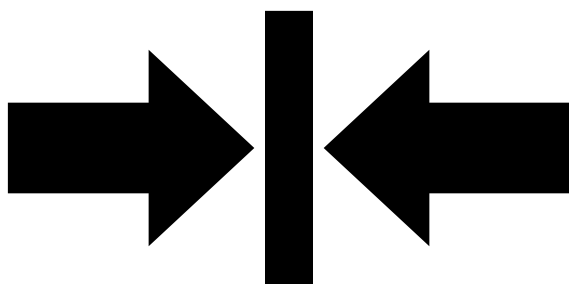

Both Arrows & Bar: This signal, together with a beeping sound, indicates you are directly over trace path.

Adjusting the Gain:

The gain setting determines how sensitive the receiver is to a signal, and is therefore an important adjustment. If the gain is set too low no signal will be detected and if it's set too high accuracy is reduced and tracing the wrong conductor is likely.

Gain can be set manually or automatically. To set gain automatically, just turn the control clockwise until it clicks, or in the case of the XTpc by *not* pushing the up and down arrows - the XTpc is in the automatic gain mode when turned on. To set manually, turn the control up or down as needed, but with the TraceMaster don't turn so far counter-clockwise that it clicks.

Set the gain with the receiver directly over the targeted line. You can use the gain control's numeric strength indicator as a guide. As a rule of thumb, the gain should be set to the lowest setting that still shows a clear peak over the trace path. The signal strength should not approach 999, as this is usually too high. Good gain setting usually yields signal strength between 200 and 800. As you move away from the transmitter, signal strength drops and you will have to adjust gain periodically.

Sweeping:

Sometimes you will want to locate all conductors in a given area, rather than tracing an individual line. This is done by sweeping. Use the inductive method to apply the highest frequency available - all underground conductors will carry signal. Walk in a grid pattern as shown in the illustration, sweeping

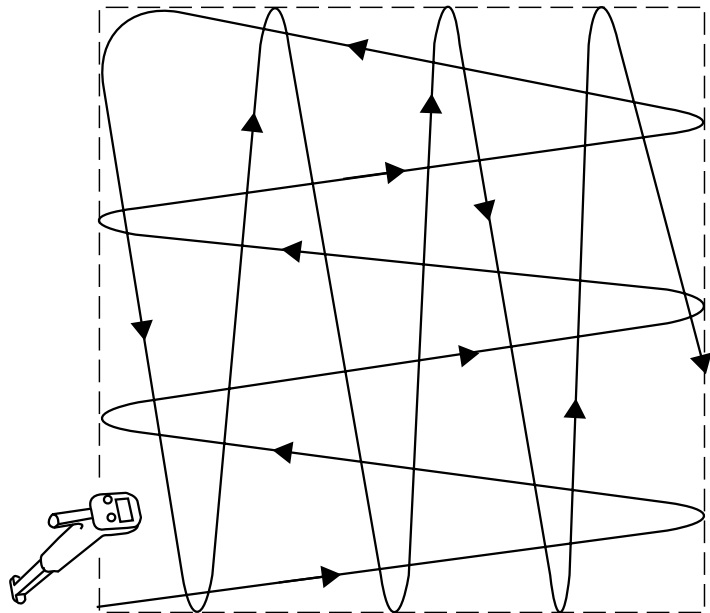

in two perpendicular directions. When you get a response, stop sweeping, move the transmitter to that point and trace the conductor you've found out of the area of interest, marking as you go. Then return to your starting point and resume sweeping, looking for more conductors to trace. When finished sweeping using the inductive method, sweep again using passive power mode. This technique will reveal all grounded metal pipes and cables, and non-conducting lines with properly installed tracer wires.

Tracing:

To trace an individual pipe or cable, it's best to apply signal to the targeted line with the conductive method or the inductive clamp method. If this isn't possible, you can still use the inductive method but other conductors are more likely to pick up a signal.

Move slowly while tracing the cable, moving the receiver side to side over the trace path. Pay attention to handle alignment. Mark the path as you go, and, if in manual gain mode, remember to adjust gain periodically as you move away from the transmitter and signal strength declines.

Milliamp Display of Signal Strength:

In addition to the red and green indicators of signal strength described in following chapters, the Schonstedt XTpc and TraceMaster pipe and cable locators will both display the strength of signal in milliamps.

On the XTpc, this is as simple as selecting Auto Mode on the transmitter: milliamps are noted on the transmitter LCD display.

On the TraceMaster, you must press the "show status button" on the transmitter. After a short delay, no more than ten seconds, the milliamp reading will flash on the receiver LCD. This feature is not available for the 455 kHz frequency.

For both receivers, this feature applies to the conductive mode only. A reading of 30 to 40 milliamps generally indicates a good signal. A lower reading indicates a weaker signal.

1

LOCATING POWER CABLE

(Note: See Introduction for an explanation of 60 Hz locating)

Applying Signal to Power Cables - Conductive Method:

You can apply signal directly with the conductive clip in several different places, including the transformer, meter, and the targeted cable.

Transformer: If you don't need to isolate a particular cable, you can apply signal to all the neutrals (primary and secondary) grounded at a particular transformer by simply connecting the transmitter to the transformer cabinet. You don't need to cut power to any lines or even open the cabinet.

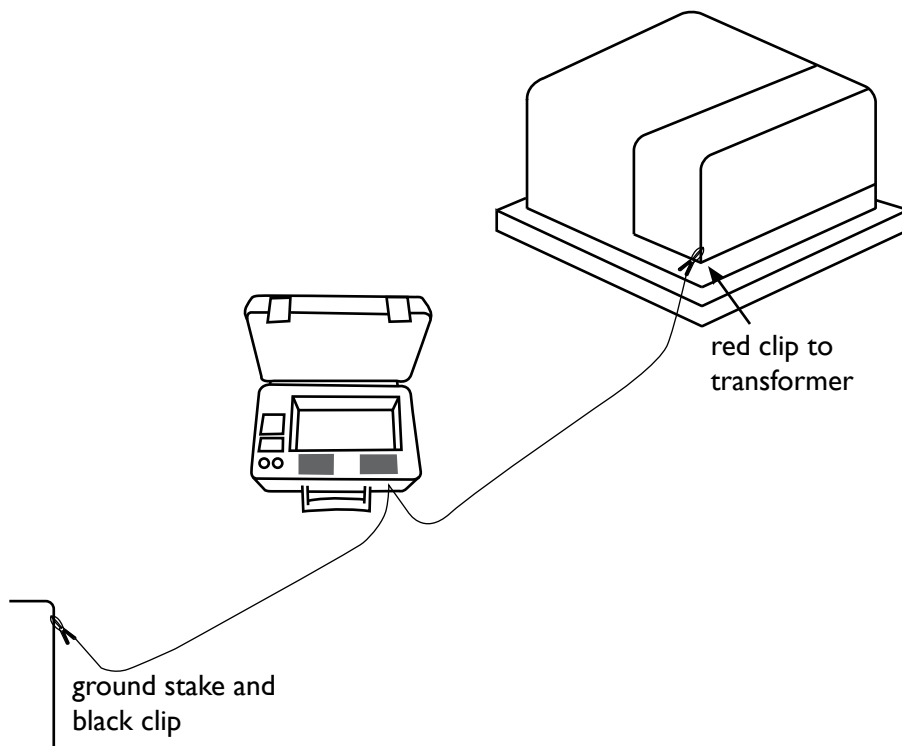

Meter: The secondary neutral is grounded at both the transformer and the meter, so secondary cables can be traced by connecting the transmitter directly to the meter's metal box. Since, typically, the transformer is better grounded than the meter, you are likely to get a better signal when connecting to the meter. Remember to place the transmitter's ground stake well away from the meter - you may have to extend it with insulated wire.

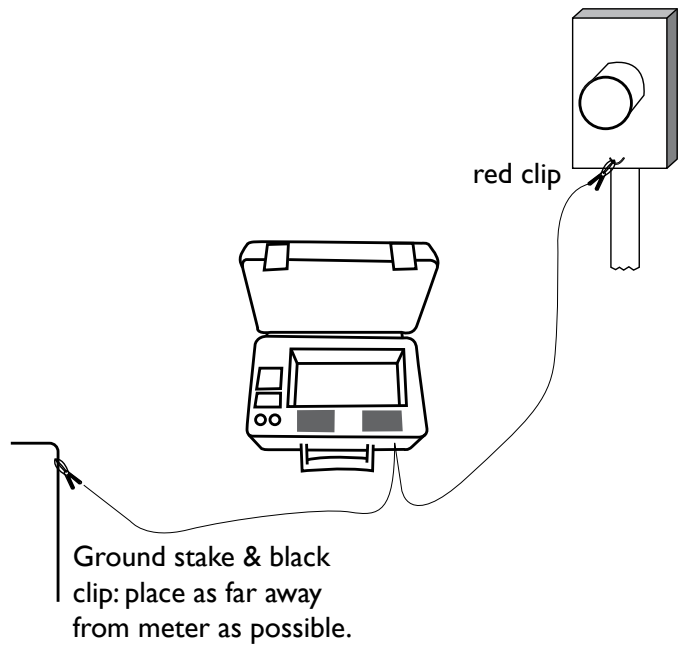

This is a fast, convenient signal application technique, as you don't have to break the meter seal. Use the lowest frequency available, usually 575 Hz, in order to minimize the propagation of signal to other lines in the area.

Targeted Cable: If power has been cut to a cable, and the far end is grounded, you can attach the conductive clip directly to the targeted cable, thus isolating the cable. See illustration.

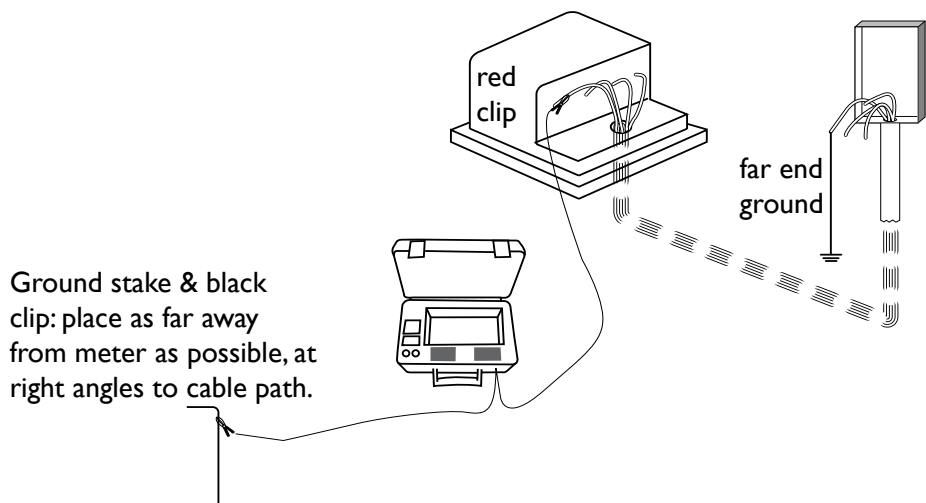

Applying Signal to Power Cables - Inductive Method:

The inductive method can be used on primary and secondary cables. The best way to trace a particular cable with the inductive technique is to set the transmitter down over the cable and set it to the 82 kHz frequency, or 33 kHz frequency if you are using the XTpc-33 kHz locator. Then move out at least 50 feet away from the transmitter and find a clear peak and mark it. Set the transmitter at this point and work back to the original location, confirming that you are on the correct trace path. Leapfrogging the transmitter like this is also a good way to trace cables that conduct poorly and give a weak signal. If the signal is very weak, try a higher frequency.

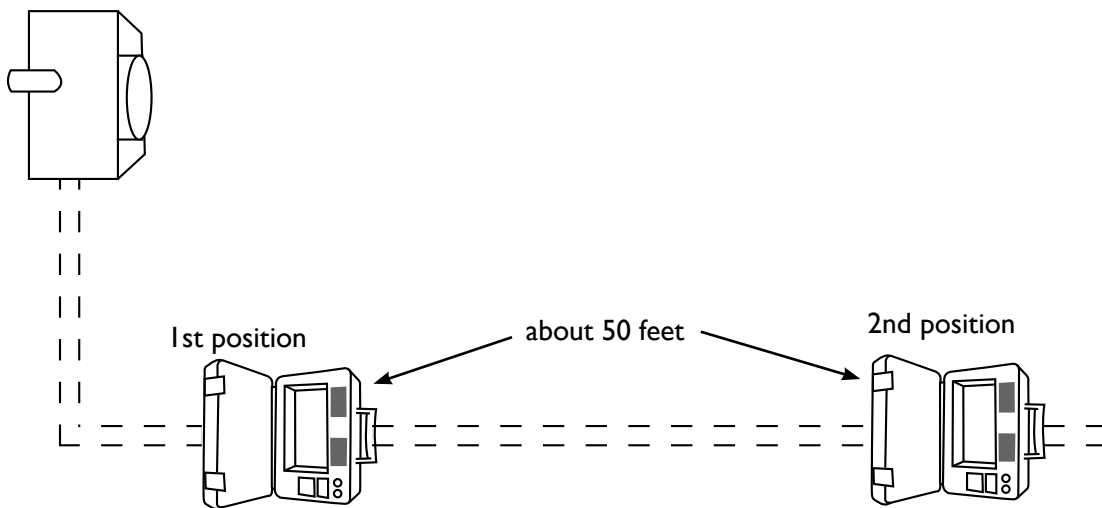

Applying Signal to Power Cables - Inductive Clamp Method:

Only use the inductive clamp to apply signal to the neutral of primary energized cables - never to the primary cable itself. A circuit path for the signal is formed by the neutral and its grounds. Using the inductive clamp to apply signal to the neutral between grounds will give readings all along the section between the grounds. Of course, the clamp jaws must always be fully closed around the cable. You

should start with a frequency of 82 kHz or, if you are using the XTpc-33 kHz locator, 33 kHz. Try higher frequencies if needed.

If you are locating a three-phase primary cable, you should find a spot on all the concentric neutrals as close as possible to the earth ground and connect the clamp there; the signal will be applied equally to all the cables. See illustration.

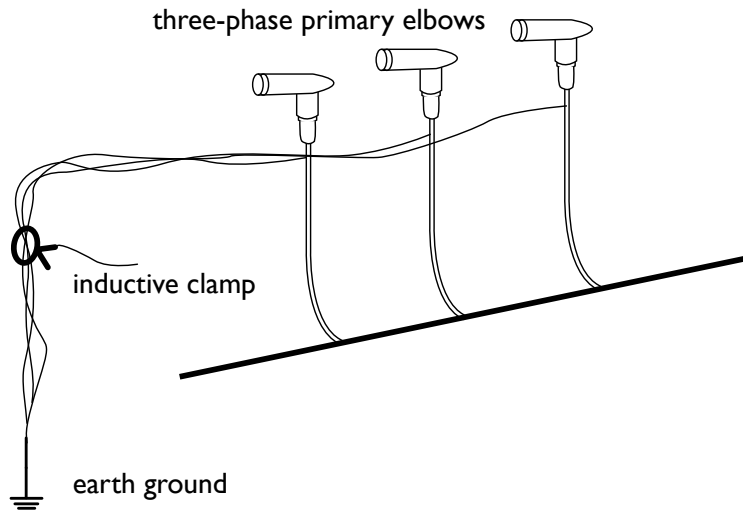

Never place the clamp around an individual primary cable; this is dangerous and inefficient. Since cables are close to each other, in the same trench, the signal will cancel itself as it travels in opposite directions along cables.

If you are locating single-phase primary cable in a loop configuration, you don't have to worry about canceling. Use the inductive clamp to apply to the targeted cable's individual concentric neutral. See illustration.

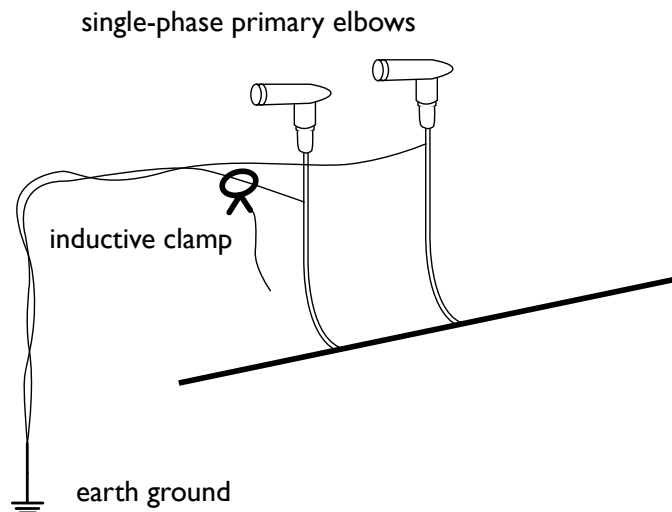

Applying Signal to Secondary Cables:

When locating secondary cables, the meter box is the most convenient place to access the neutral. There are several ways to apply signal. **Sometimes the riser pipe is non-metallic, usually PVC - if this is the case, you can put the clamp right around the riser.** If the riser is metallic, or if you can't fit the clamp around it for some reason, you can break the meter's seal and clamp around the neutral inside the box as shown.

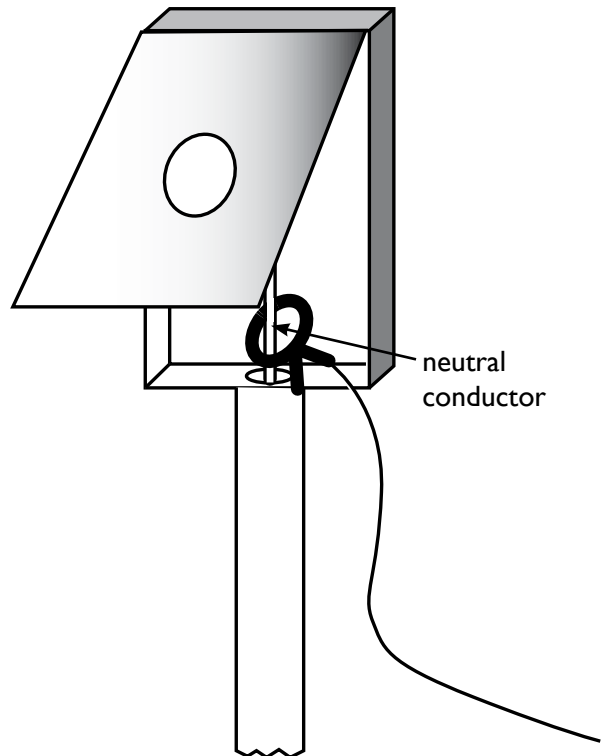

The meter box might ground via an external wire that goes to an earth ground. If so, you can clamp around this external ground, since it is connected to the neutral inside the box. Other utilities might also be using this ground wire, and you must place the clamp above them to avoid applying signal to them as well.

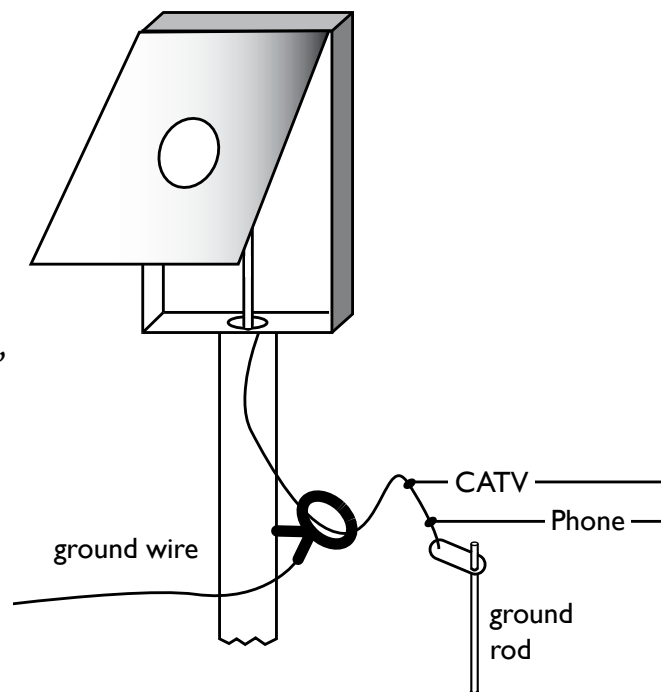

Identifying Slack Loops:

While tracing, you may notice an abrupt weakening of signal strength. If the signal just as abruptly returns to at or near the same strength, you may have come across a slack loop as illustrated below. To verify this, mark the spot and then back up a few feet. Trace the path again, but this time hold the receiver handle perpendicular to the trace path. The signal will be much weaker, but may return to full strength at the marked point and then quickly decline again - the reverse of the previous pattern. If this is the case, you have probably found a slack loop.

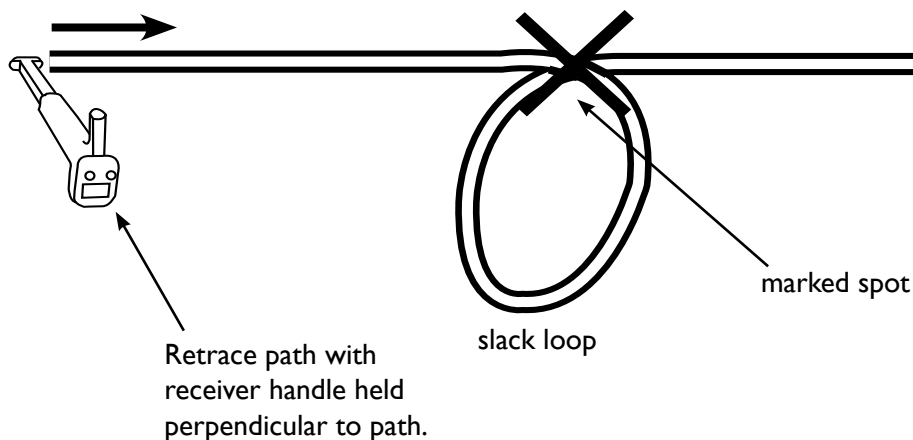

Identifying a Cable Open End:

Power cables are occasionally left with open ends, either because they have been severed, or buried in anticipation of future use. If the cable end doesn't ground due to insulation, try this technique:

Assuming the cable is grounded at the access point, use the inductive clamp method to apply signal. Alternately, where the access end is not grounded, use the conductive method. In either case you should use the highest frequency available. Now trace the cable normally - signal will abruptly stop at the open end.

Locating Buried Streetlight Cables:

Power lines for streetlights present special challenges. They are often powered off during the day, and since the supply is a transformer they can appear to be ungrounded when the power is off. Locating by means of passive power frequencies, 50 or 60 Hz, will not work. Try using the inductive clamp, connecting at the base of the light as shown and using the highest frequency available. Be cautious and check all nearby lights before digging.

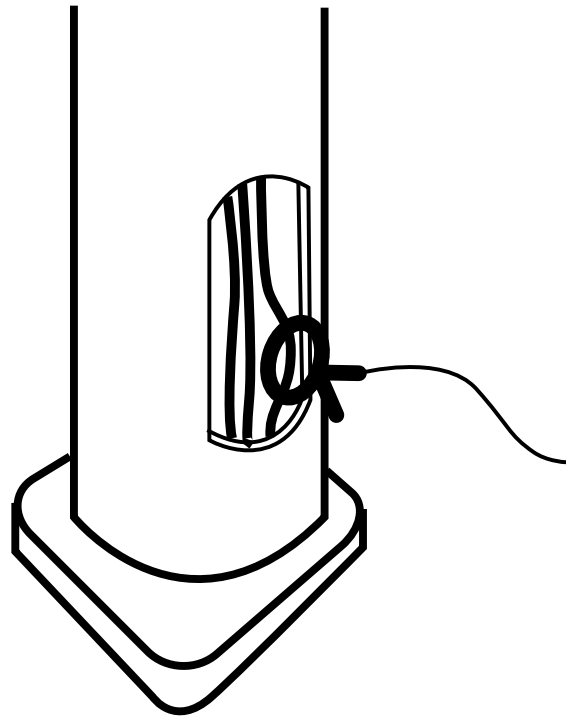

2

LOCATING PIPE:

Applying Signal to Pipe with the Inductive Method:

The best way to trace a pipe with the inductive technique is to set the transmitter down over the presumed pipe path and set it to the 82 kHz frequency. The arrow on the case should be aligned with the path. Then move out at least 50 feet away from the transmitter and find a clear peak and mark it. Set the transmitter at this point and work back to the original location, confirming that you are on the correct trace path. Leapfrogging the transmitter like this is also a good way to trace pipes that conduct poorly and give a weak signal, and you can extend range or get past insulated pipe joints by moving the transmitter ahead as needed. If the signal is very weak at 82 kHz, try a higher frequency.

Unfortunately, the XTpc-33 kHz locator will not work well for locating pipe, as 33 kHz is usually too low of a frequency to give a good signal on steel or ductile iron pipe.

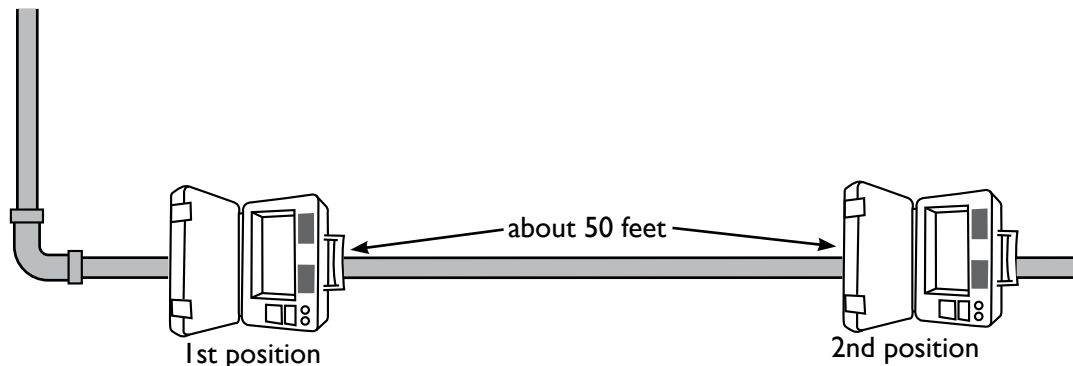

Applying Signal to Pipe with the Conductive Method:

The conductive method is a good way to apply signal to metal pipe. You can attach the clip at a valve or meter, or directly to the pipe itself. Ground the transmitter as described in Chapter One, then insert the conductive cable into the transmitter jack. To create a circuit, apply a ground at the far end of your locating area using, for example, a length of wire and a screwdriver; this will confine signal to the length of pipe between the transmitter ground and the far end ground. But be aware, some pipes are connected with non-conducting gaskets or joints, which will severely limit the length of your trace.

If you can't find a place to apply a far end ground, the conductive method will still work, but signal will travel both directions from the transmitter, and response will rapidly decrease as you move away from the transmitter. The rate of decrease is affected by the pipe diameter and the frequency you choose. One general principle that increases the length of trace is to use low frequencies with large diameter pipe and high frequencies with smaller pipe. In all cases, use the lowest frequency that gives adequate response.

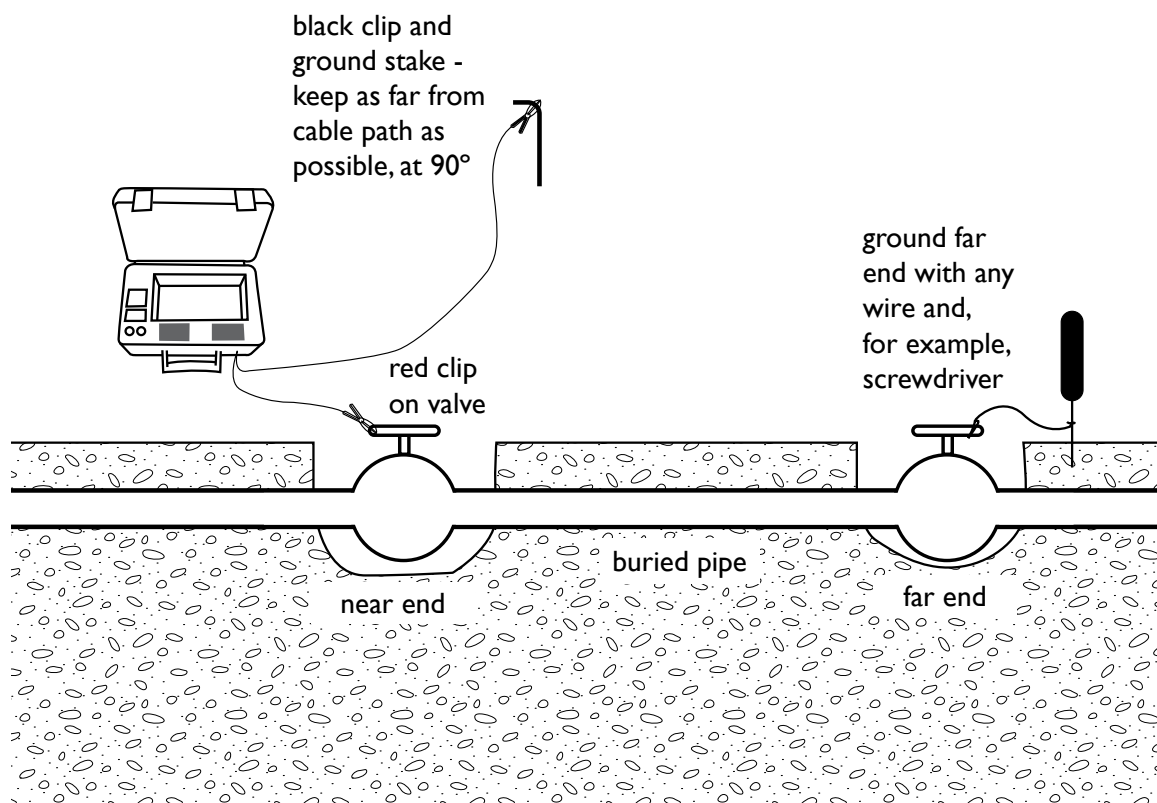

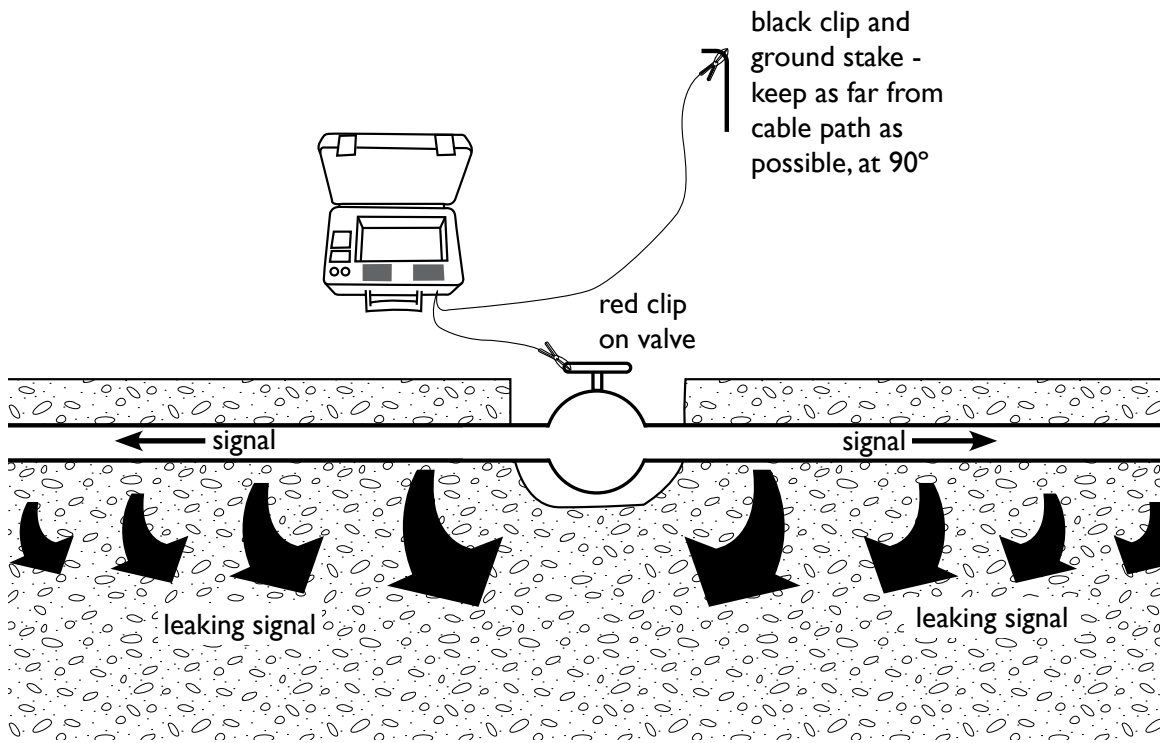

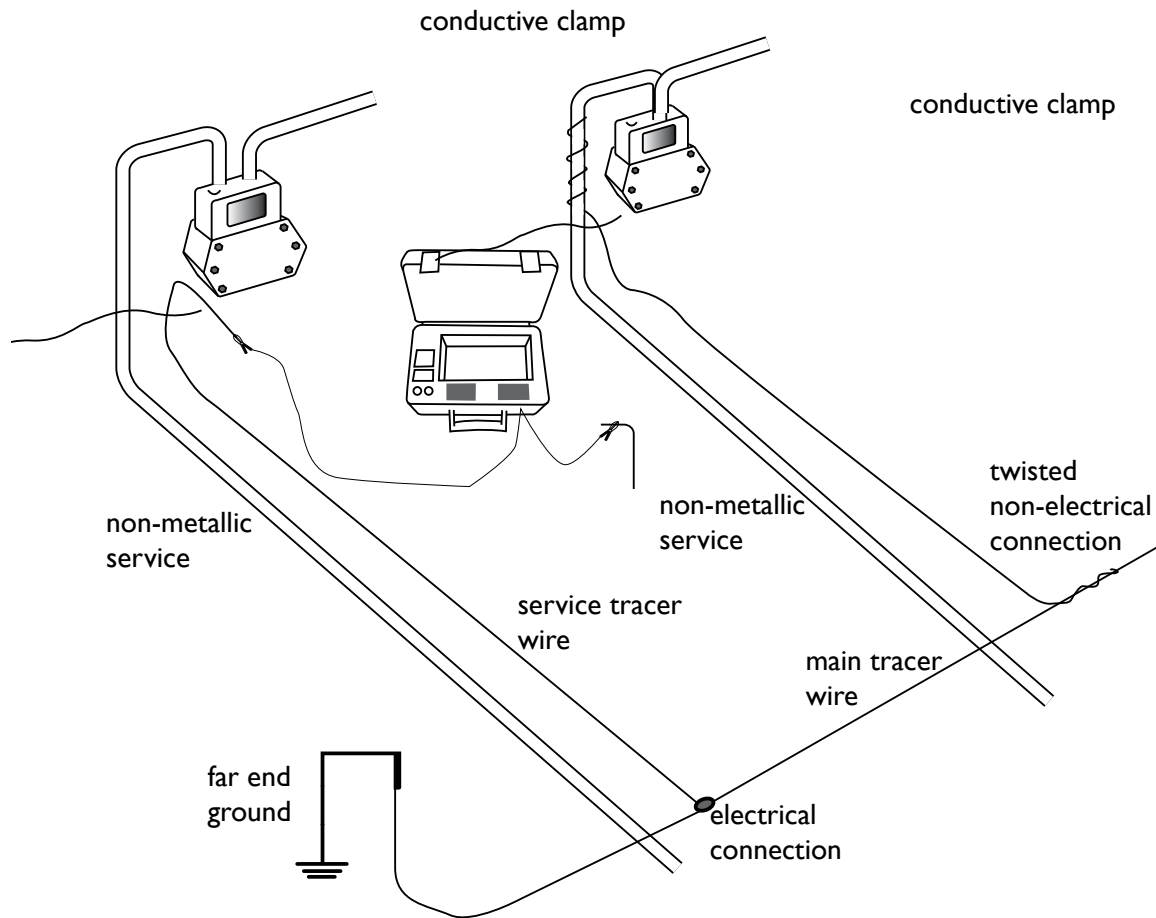

Conductive Method on Tracer Wires:

Sometimes non-metallic pipe, such as PVC or HDPE, is equipped with tracer wires that run the length of the installed pipe. This is easy to trace by attaching the conductive clip to the wire, setting the ground as described in Chapter One, and plugging into the transmitter jack. As with metallic pipe, it is best to apply a ground at the far end of the tracer wire; this allows use of a low frequency that will give signal over a long distance. If applying a far end ground is not possible, use a higher frequency.

In some cases, the tracer wire on a service line or lateral is not electrically connected to tracer wire on the main line - the idea is to limit signal to one of the lines at a time. If the transmitter is not too far away from the main line connection, it is worth trying a high frequency; in some cases signal may transfer to the main line wire and allow tracing.

Applying Signal to Pipe with the Inductive Clamp Method:

The inductive clamp method is an excellent way to locate underground metallic pipe, and can often be applied by digging and exposing enough of the pipe to allow placement of the clamp.

Used by itself, without a ground, signal will travel both directions from the clamp, and response will decrease rapidly. You can confine signal to one direction by attaching a ground - using, for example, the ground stake and a length of insulated wire - on the opposite side of the inductive clamp.

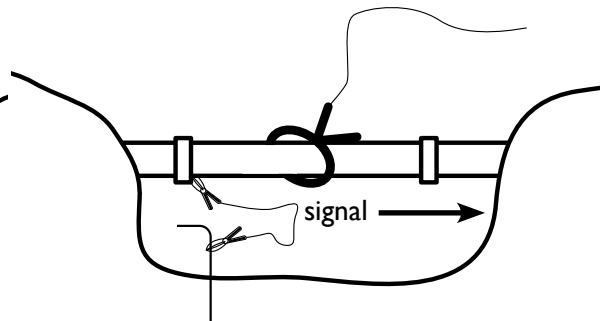
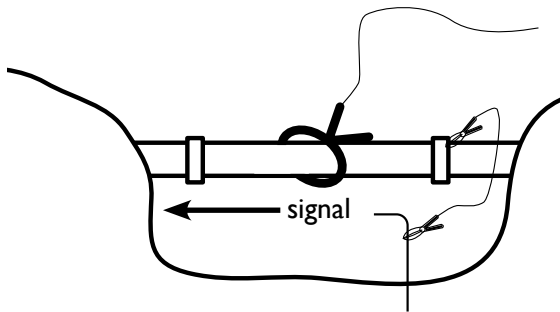
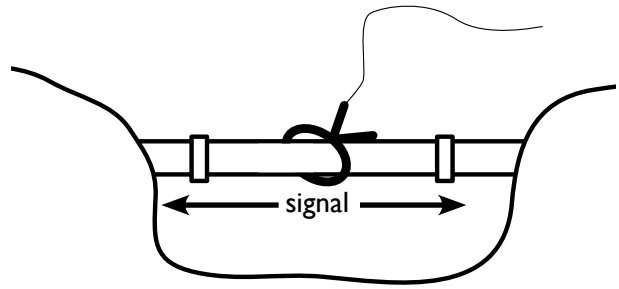

One special case occurs when you use the inductive clamp method on a gas meter's metallic service pipe; in this case, always apply a ground to the pipe above the clamp and below the insulating coupling, as shown, to create a good return signal. Without such a ground, the valve's insulating coupling will block the return signal and severely decrease the signal.

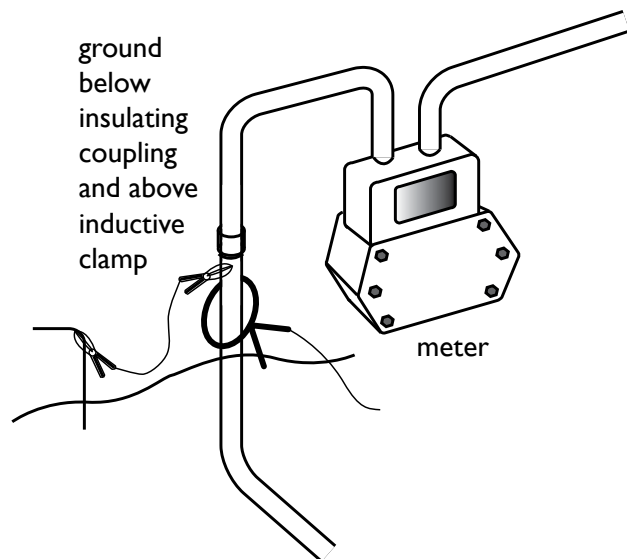

3

LOCATING TELEPHONE CABLE CABLE

Introduction:

Review the Introduction of this manual for general information on signal application techniques and locating. This chapter looks at techniques used specifically for telephone cable locating.

Applying Signal to Telephone Cables:

Inductive Method: The inductive technique is convenient because no access to the cable is needed - just set the transmitter on the ground directly over the cable and line up the transmitter arrow parallel with the suspected cable path. But the inductive technique also tends to apply signal indiscriminately to all nearby conductors, and is a poor choice when attempting to trace a particular cable. The best way to trace a particular cable with the inductive technique is to set the transmitter down over the cable and set it to the 82 kHz

Underground cable; transmitter should be placed directly over cable with arrow on case lined up with cable path. If transmitter is more than a couple of feet away from cable path, signal will be very weak.

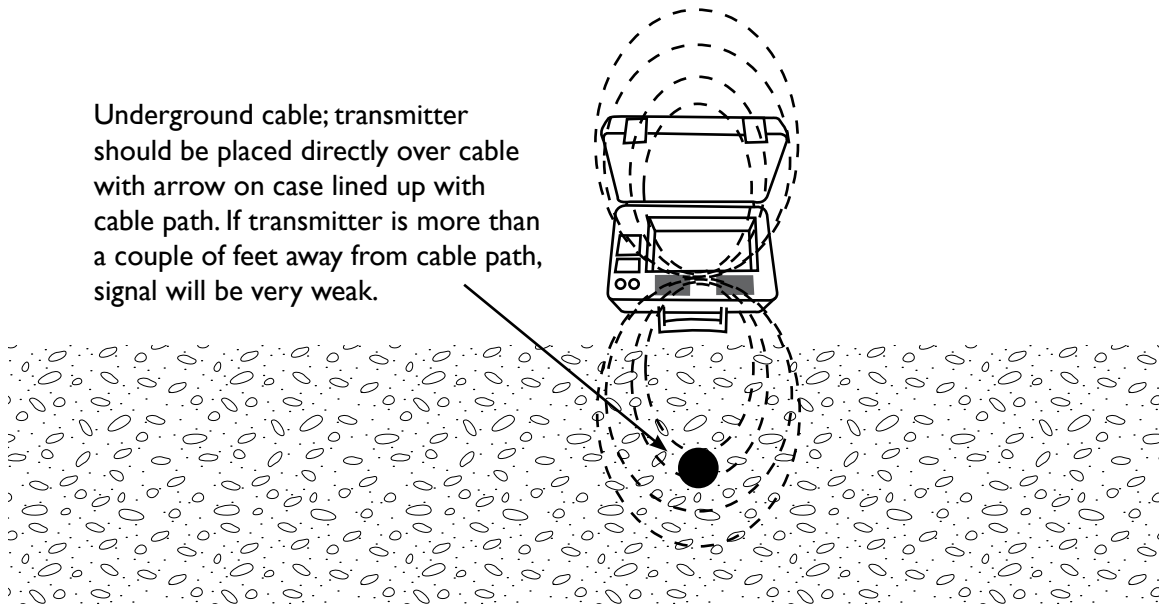

or 33 kHz frequency. Then move out at least 50 feet away from the transmitter and find a clear peak and mark it. Set the transmitter at this point and work back to the original location, confirming that you are on the correct trace path. Leapfrogging the transmitter like this is also a good way to trace cables that conduct poorly and give a weak signal. If the signal is very weak at 82 kHz and you are using a TraceMaster multiple frequency locator, try the 455 kHz frequency.

Conductive Method: The conductive method is a good way to trace a particular cable, as signal can be applied directly to the targeted cable and the cable can be traced for long distances - up to a mile. Be sure the connection between the transmitter clip and the conductive portion of the cable is clean and secure, without any rust, dirt or paint. Using the 575 Hz frequency on the TraceMaster is a good way to confine the signal to the targeted cable, but keep in mind that the signal will not travel beyond a break.

To make the connection to the telephone cable you need access to the cable shield. Connect the red transmitter clip to the cable by disconnecting the shield bond at the near end, but do not disconnect the far end shield bond as it provides a good ground for the cable's far end. A good ground is also needed, as explained in the first section of

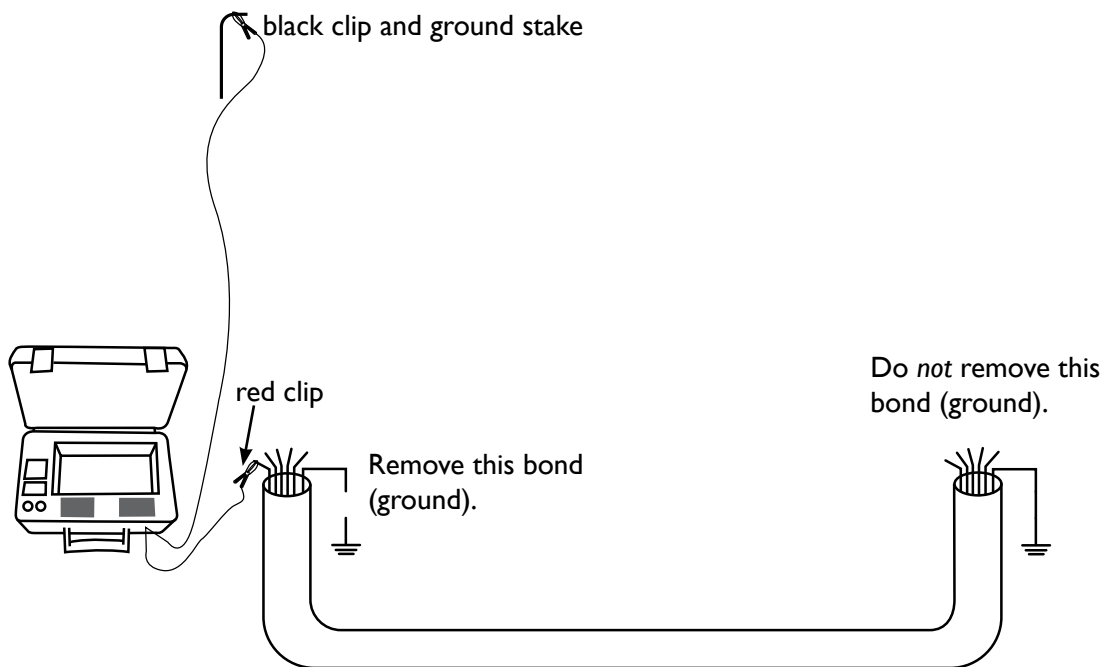

this manual; don't ground to water pipes or other conductors as the return signal can complicate locating.

Turn the transmitter on, using the lowest frequency that gives a clear signal. On the TraceMaster circuit quality is indicated by the OUTPUT POWER LED. If the LED is green, impedance is below 2 k ohms, indicating a good circuit. If the LED alternates between green and red, impedance is probably between 2 and 4 k ohms, indicating an adequate circuit. If the LED is continuously red, the impedance is higher than 4 k ohms.

If the LED is red, or alternating red and green, try to improve the circuit. Check that the connection to the cable is tight and clean, check all cables, check the ground, etc. But fairly often the circuit is as good as it's going to get. You can still locate with a poor circuit, but you'll probably have to increase receiver gain and you may not be able to trace for as long a distance as you could with a better circuit.

Inductive Clamp Method: The inductive clamp method is a nice compromise between the conductive and inductive methods. You can use the inductive clamp to apply signal to a particular cable without having to disconnect that cable.

The clamp plug should be inserted into the transmitter jack BEFORE switching the transmitter on. Also, the clamp must always close fully around the targeted cable. Clamp placement is very important, as described on page 28.

If you place the clamp around the cable above the ground bonding, the signal will travel to the ground, not to the targeted cable. Therefore, the clamp must be placed between the ground bonding and the cable's point of entry into the ground.

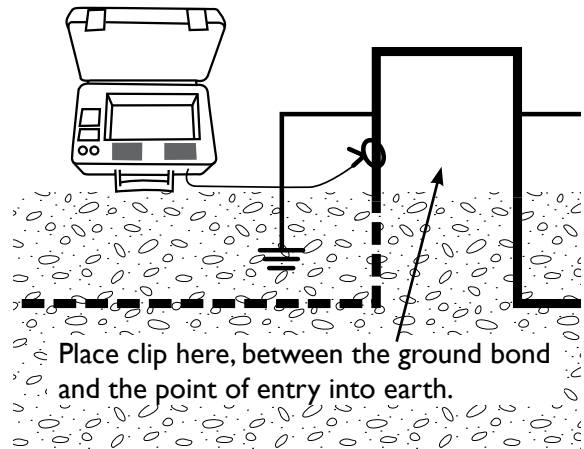

Where the cable is short, e.g. a service drop, the clamp should be connected on the grounded end, not the ungrounded end. If you only have access to the ungrounded end, use the ground stake and wire to provide a ground.

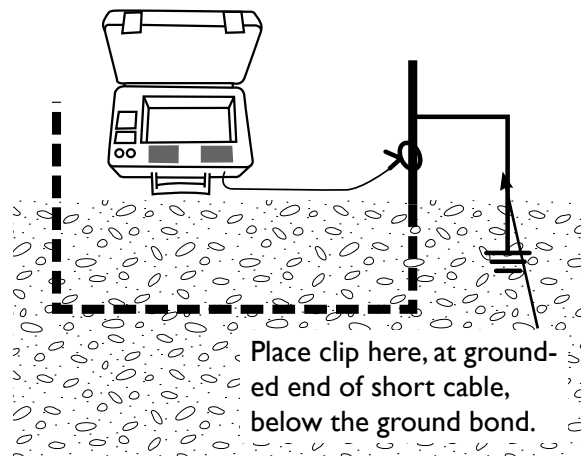

The inductive clamp method is not a good choice for cables with ungrounded shields at both ends. But if the cable is long, you can remove the bonding, apply the clamp, and signal will go both ways. Since there are no grounds, you should use the highest frequency possible.

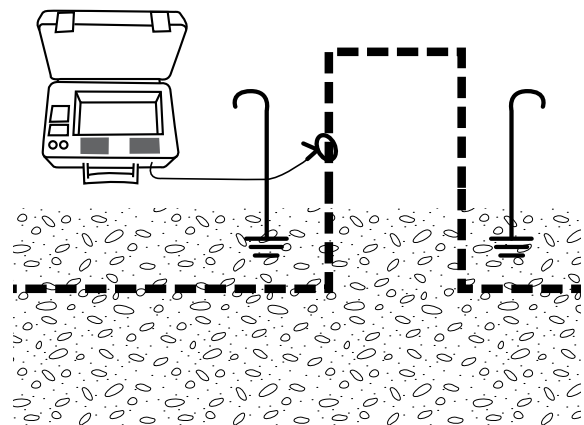

You can still use the inductive clamp method where several cables have a common grounding point. Signal will propagate through all the cables, but the cable you have isolated with the clamp will have the strongest signal.

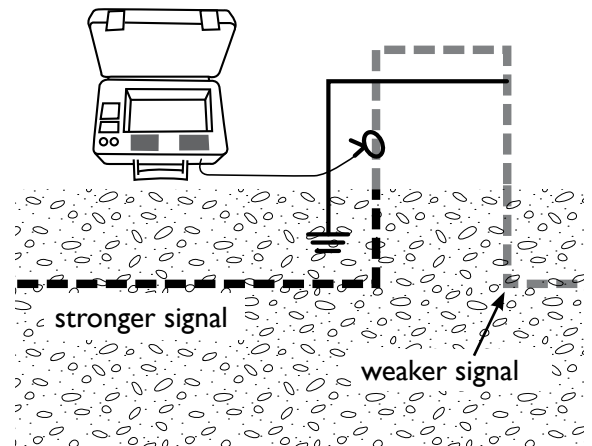

You can use the inductive method on cables that split at laterals or drop lines. Hook up the clamp and ground as always, and begin tracing. You will notice a drop in signal power when the receiver comes to a junction - this is a good way to find laterals.

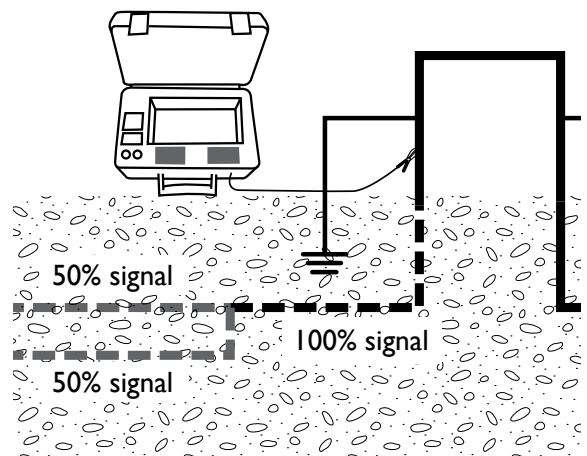

Locating Slack Loops and Butt Splices:

While tracing, you may notice an abrupt weakening of signal strength. If the signal stays weaker from that point forward, you have probably found a lateral, as described above. But if the signal just as abruptly returns to at or near the same strength, you may have come across a slack loop or butt splice as illustrated below. To verify this, mark the spot and then back up a few feet. Trace the path again, but this time hold the receiver handle perpendicular to the trace path. The signal will be much weaker, but may return to full strength at the marked point and then quickly decline again - the reverse of the previous pattern. If this is the case, you have probably found a slack loop or butt splice, though you should still check for an unknown lateral, as described below.

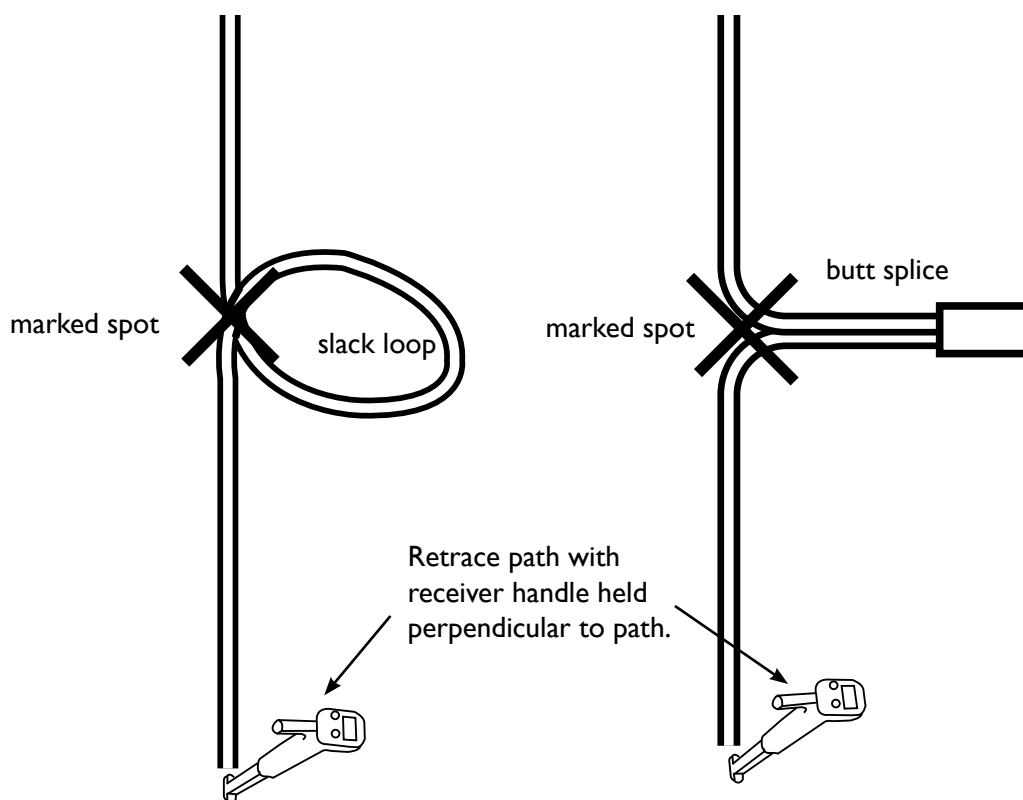

Locating Unknown Laterals:

To check for unknown laterals extending from butt splices or other junctions, return to the points marked in the above procedure. Find a peak signal on the known trace path somewhere between 10 and 25

feet from the mark. Now walk in a circle around the mark, holding the receiver so that it points at the mark - not so that it is aligned with your circular path. The receiver should remain fairly quiet, unless you cross over a lateral. Mark any responses and complete the circle - there may be more than one lateral. Trace these laterals as needed.

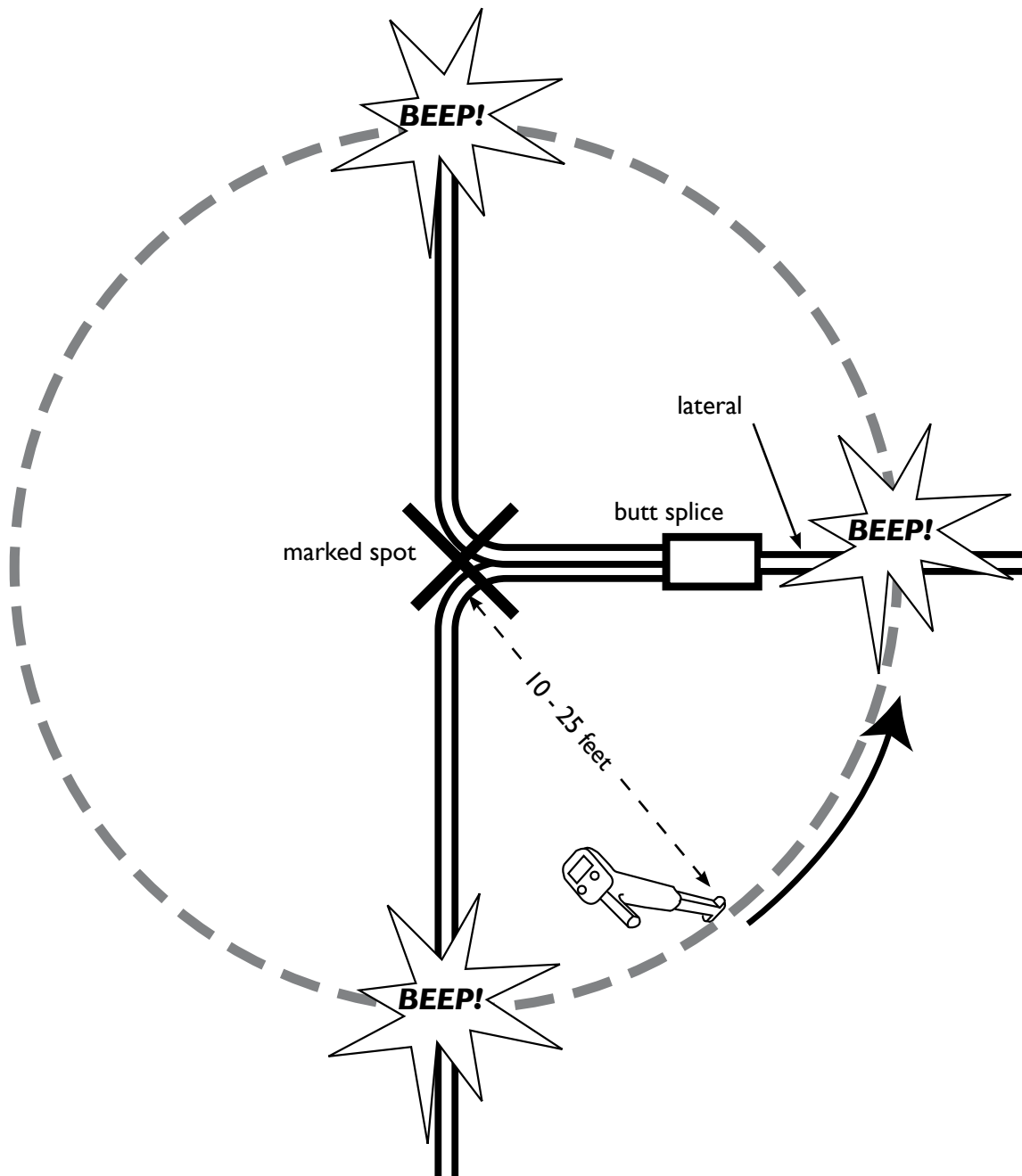

Locating Cables from Pedestals:

When starting at a pedestal and tracing a single cable, follow these steps:

At the pedestal, use the inductive clamp method to apply signal to the targeted cable. The header in the pedestal may be grounded, but if not, use wire and the ground stake to ground it yourself.

Now walk in a circle 10 to 25 feet away from the pedestal, holding the receiver so that it points at the pedestal - not so that it is aligned with your circular path. When you get a response, stop, find the peak, and adjust gain. Make a note of the numeric strength reading. Now continue walking around the pedestal and repeat these steps each time you get a response. When you have completed the circle, the response with the highest strength reading is the targeted cable, and may be traced as needed.

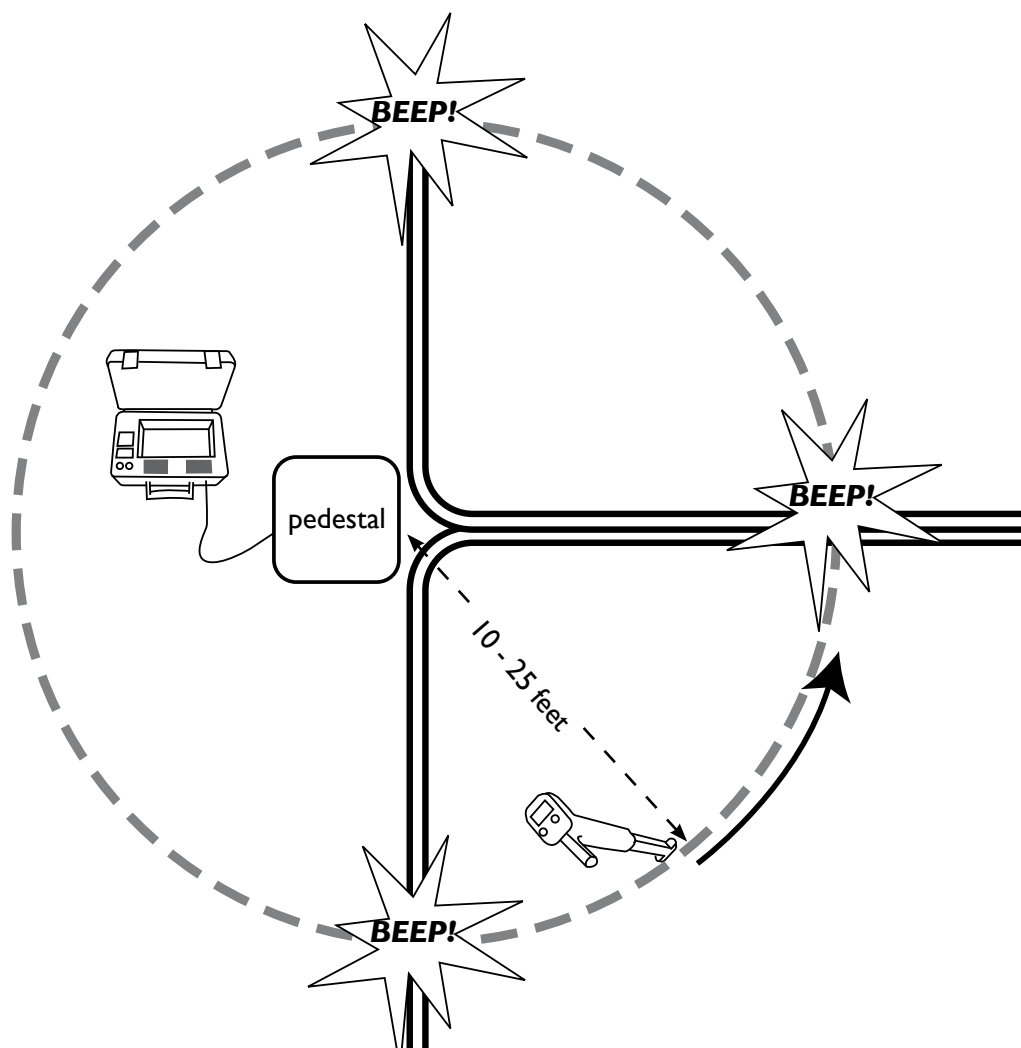

Locating Service Drops:

When tracing service drops, it is usually best to use the house or building as the starting point and apply signal with the conductive method. Then trace as usual.

Locating an Open End:

Follow these steps to locate a cable with an unterminated or open end: Where the cable is bonded to ground at the starting point, use the inductive clamp method to apply signal. If the cable is not bonded to ground, use the conductive method. In either case, use the highest frequency possible. Trace as usual; the response will drop off abruptly at the break or open end.

Locating Fiber Optic:

Can Fiber Optic Cable be Traced?

Optical fibers in themselves can't be traced with a utility locator - they are not conductors. But typically one of several types of conductor is included along with the fiber optic cable. This might be a metallic sheath around the fiber, a metallic wire woven into the sheath (for strength and locating), or an insulated wire may have been pulled through the same duct as the fiber. If none of these are present, you will have to use site plans or physical location.

Underground fiber optic cable is usually installed in a duct, or in a tube run through a large duct. Typically the cable is run from a central office to a remote terminal office, and there may be several splice points along the way, accessed by manholes or hand holes. Where good practices are followed, the metallic sheath or woven wire will be grounded at both ends. But particular grounding policies vary by company, and you should make no automatic assumptions. Sometimes grounding is via remotely actuated relay or voltage transient suppression device.

In some cases, fiber optic installations have their own rack-mounted transmitter that can apply signal selectively. If this transmitter applies a 575 or 512 Hz, and your receiver has a 512 Hz mode (the sonde mode) then the cable can be traced using the installation's transmitter and your receiver.

Attaching at a Central or Remote Office:

If there is no installed transmitter, or if it doesn't match up with your receiver, you can still apply signal at the central or remote office, using your transmitter and the conductive method.

To attach the clip, find the ground point for the fiber optic cable's conducting wire - this is usually near the rack mounted digital conversion equipment. Disconnect the wire, then connect your transmitter to it and to the ground point as shown in the illustration. Put the conductive plug in the transmitter jack, turn on the transmitter, and choose the lowest frequency available in order to

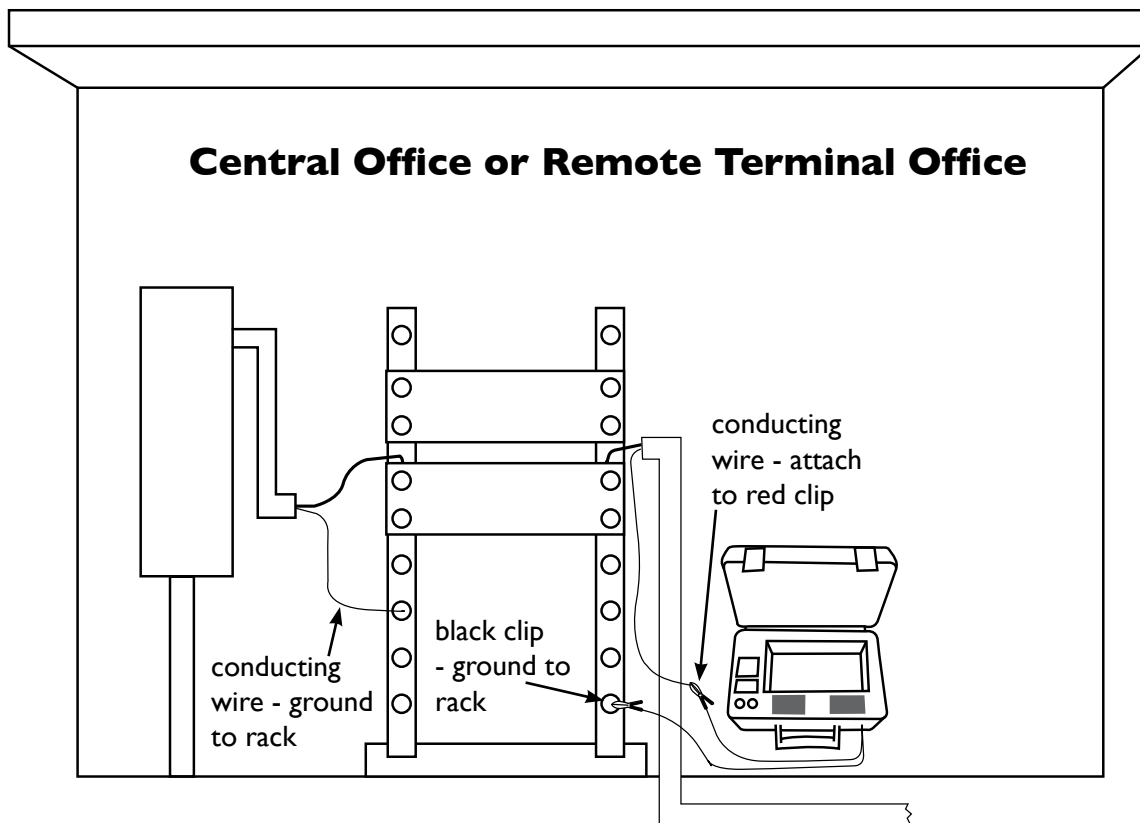

transmit signal as far as possible.

Circuit quality is indicated by the OUTPUT POWER LED. If the LED is green, impedance is below 2 k ohms, indicating a good circuit. It could be that the circuit is too good - possibly the conducting wire is grounded elsewhere in the office. If you detect no signal outside the office, this may be the reason.

If the LED alternates between green and red, impedance is probably

between 2 and 4 k ohms, usually indicating an adequate circuit. But it may also indicate an open somewhere between this connection point and the ground at the terminating end or at splice points. If the signal outside the office is present, but weak, this may be the reason. If the LED is continuously red, the impedance is higher than 4 k ohms, usually indicating an open circuit or no ground at the far end. If the LED is red, or alternating red and green, try to improve the circuit. Check that the connection to the cable is tight and clean, check all cables, check the ground, etc. But fairly often the circuit is as good as it's going to get. You can still locate with a poor circuit, but you'll probably have to increase receiver gain and you may not be able to trace for as long a distance as you could with a better circuit.

Attaching at a Splice Point:

If you see that a splice case has one or two metal straps leading to the ground, it's grounded and you can hook your transmitter to it. If there are two straps, odds are that one of them is attached to the metallic sheath or conducting wire on the incoming side and that the other strap is attached to the outgoing side. Alternately, they may be

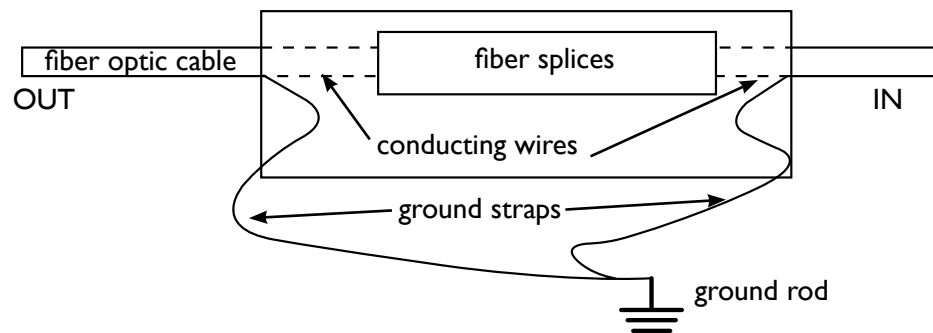

connected inside the case.

The way to get the strongest possible signal is to disconnect the straps before attaching the transmitter, but local regulations may prohibit this. If the straps can't be disconnected, the signal will split between the ground point and the outgoing and incoming cable, and the

tracing range will be reduced.

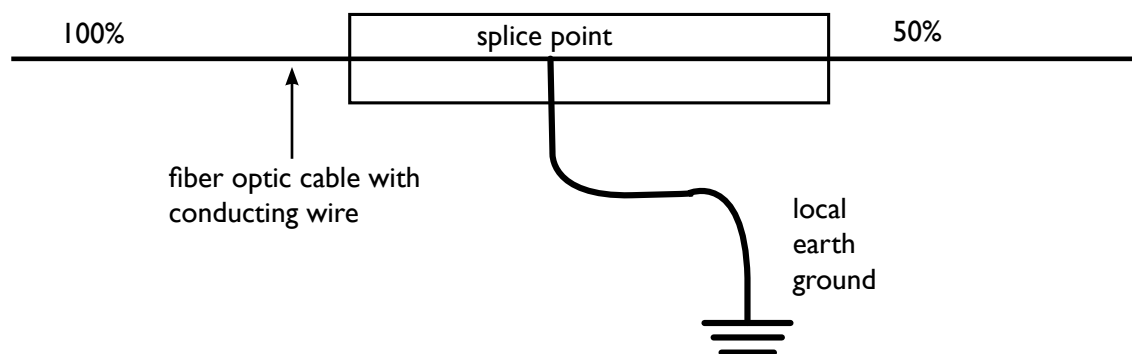

Tracing Fiber Optic Cable:

If you are starting from a central or remote office, start outside the building wherever you expect the cable to exit. Search until you get a response.

When starting from a manhole or hand hole, circle the hole as described previously, with the receiver pointed toward the hole. When you get a response, find the peak, mark the point and begin tracing.

When you trace the cable over a long distance, the signal strength will eventually decrease. This is because the signal bleeds off due to capacitance, or because you pass additional grounds at splice points. Reduction by bleeding off is gradual, and reduction at ground points is abrupt. In either case, try adjusting the gain.

4

LOCATING CATV CABLE

Applying Signal to CATV Cables, Inductive Method:

The best way to trace a particular cable with the inductive technique is to set the transmitter down over the cable and set it to the 82 kHz frequency, or 33 kHz frequency if you are using an XTpc-33 Locator. Then move out at least 50 feet away from the transmitter and find a clear peak and mark it. Set the transmitter at this point and work back to the original location, confirming that you are on the correct trace path. Leapfrogging the transmitter like this is also a good way to trace cables that conduct poorly and give a weak signal. If the signal is very weak at 82 kHz, try a higher frequency.

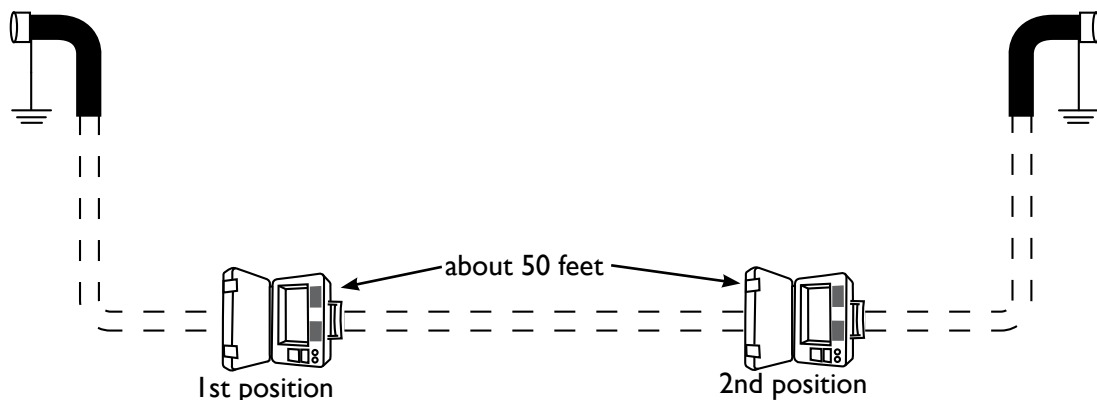

Applying Signal to CATV Cables, Conductive Method:

To make the connection to the CATV cable you need access to the cable shield. Connect the red transmitter clip to the cable by disconnecting the shield bond at the near end, but do not disconnect the far end shield bond as it provides a good ground for the cable's far end. A good ground is also needed, as explained in the first section of this manual; don't ground to water pipes or other conductors as the return signal can complicate locating.

Turn the transmitter on, using the lowest frequency that gives a clear signal. Circuit quality is indicated by the OUTPUT POWER LED on

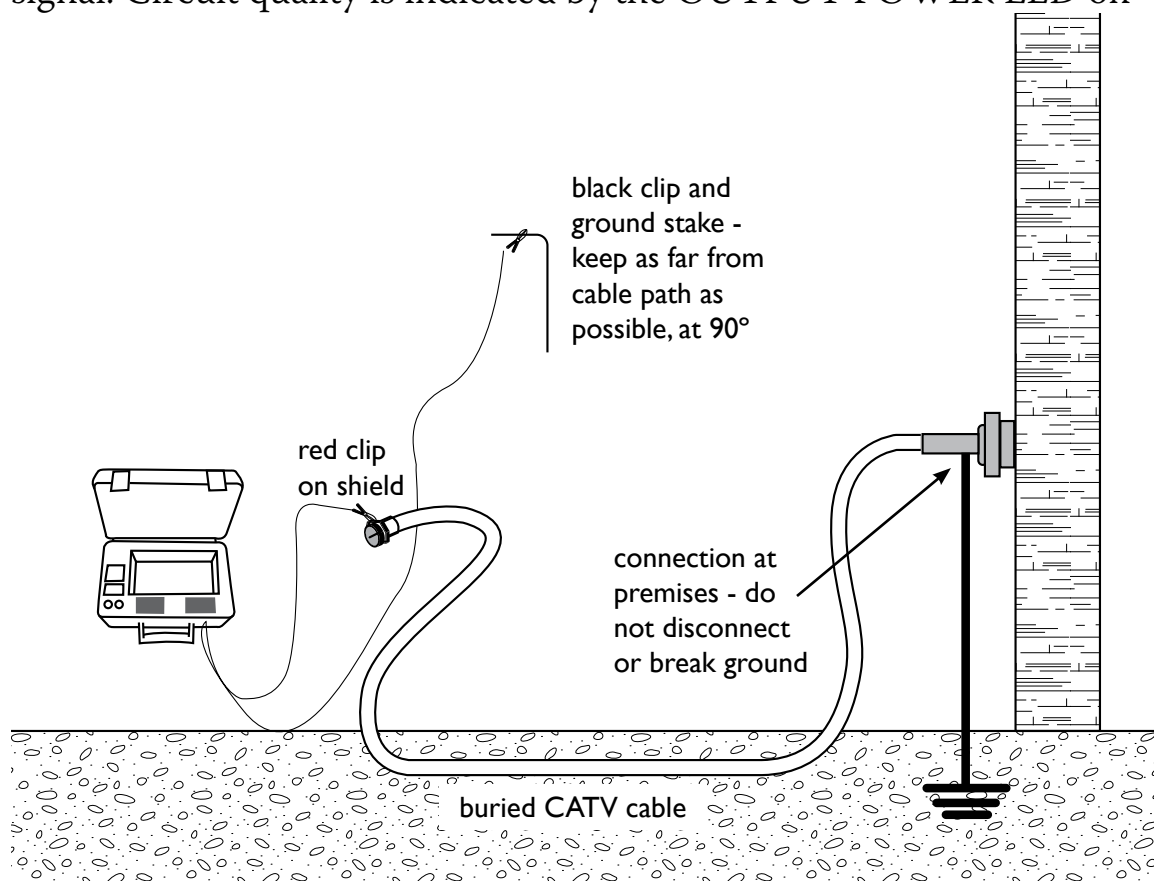

the TraceMaster. If the LED is green, impedance is below 2 k ohms, indicating a good circuit. If the LED alternates between green and red, impedance is probably between 2 and 4 k ohms, indicating an adequate circuit. If the LED is continuously red, the impedance is higher than 4 k ohms.

If the LED is red, or alternating red and green, try to improve the cir-

cuit. Check that the connection to the cable is tight and clean, check all cables, check the ground, etc. But fairly often the circuit is as good as it's going to get. You can still locate with a poor circuit, but you'll probably have to increase receiver gain and you may not be able to trace for as long a distance as you could with a better circuit.

Applying Signal to CATV Cables, Inductive Clamp Method:

Since you don't have to disconnect the cable, the inductive clamp method is usually the easiest way to apply signal to CATV cable. Just place the clamp wherever you have access to the cable, making sure that the jaws are fully closed.

Since the cable and its shield grounds, at both ends, form a complete circuit, the inductive clamp applies signal to the entire length of cable

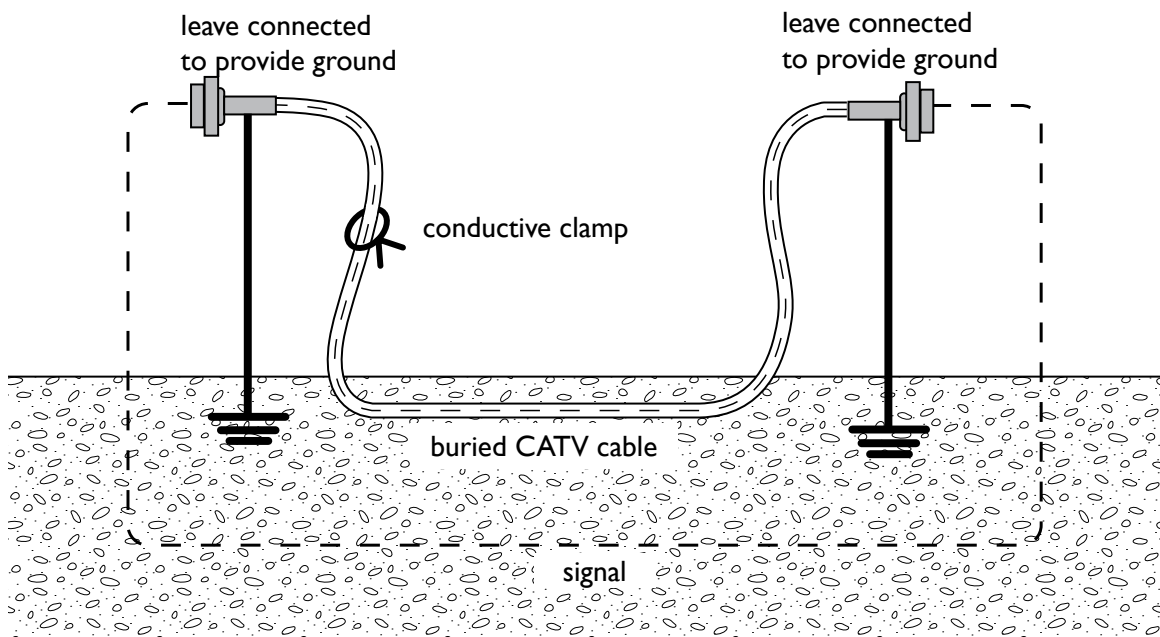

between grounds. There will always be a ground on the subscriber's premises, and the other ground may be at a bridging amplifier several blocks away. This can make for a very weak signal. But you can apply a ground yourself, nearer your access point, with the ground stake and a length of insulated wire. This will restrict signal to the portion of cable between your ground and the subscriber's ground, thus improving receiver response along that portion. Remember to remove the temporary ground when you are done locating.

Locating Cable Slack Loops:

While tracing, you may notice an abrupt weakening of signal strength. If the signal stays weaker from that point forward, you have probably found a lateral, as described in previous chapters. But if the signal just as abruptly returns to at or near the same strength, you may have come across a slack loop as illustrated below. To verify this, mark the spot and then back up a few feet. Trace the path again, but this time hold the receiver handle perpendicular to the trace path. The signal will be much weaker, but may return to full strength at the marked

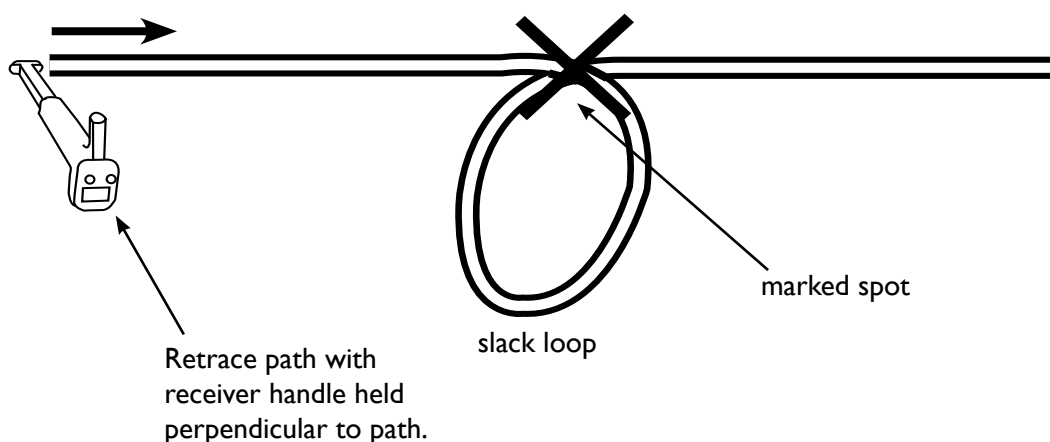

point and then quickly decline again - the reverse of the previous pattern. If this is the case, you have probably found a slack loop.

Locating CATV Cables from Pedestals:

When starting at a pedestal and tracing a single cable, follow these steps:

At the pedestal, use the inductive clamp method to apply signal to the targeted cable. There may be several cables fanning out from the pedestal, and signal will probably propagate to all of them, even

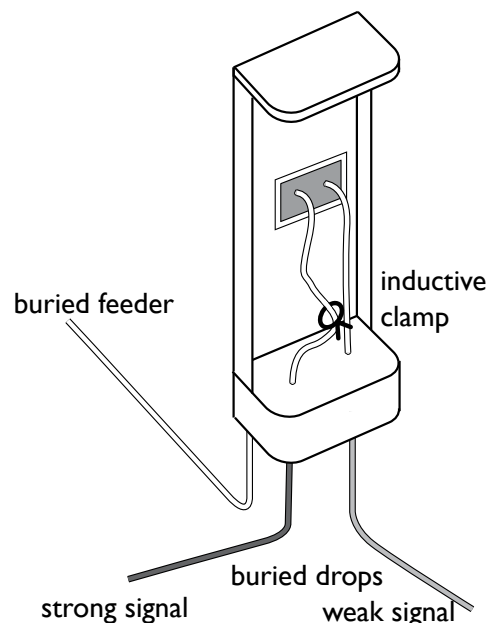

when using the clamp. However, the targeted cable - the one you enclose with the clamp - will have an obviously stronger signal. The header in the pedestal may be grounded, but if not, use wire and the ground stake to ground it yourself. This strengthens receiver response by limiting signal to a shorter portion of cable. Now walk in a circle 10 to 25 feet away from the pedestal, holding the receiver so that it points at the pedestal - not so that it is aligned with your circular path. When you get a response, stop, find the peak, and adjust gain. Make a note of the numeric strength reading. Now continue walking around the pedestal and repeat these steps each time you get a response. When you have completed the circle, the response with the highest strength reading is the targeted cable, and may be traced as needed.

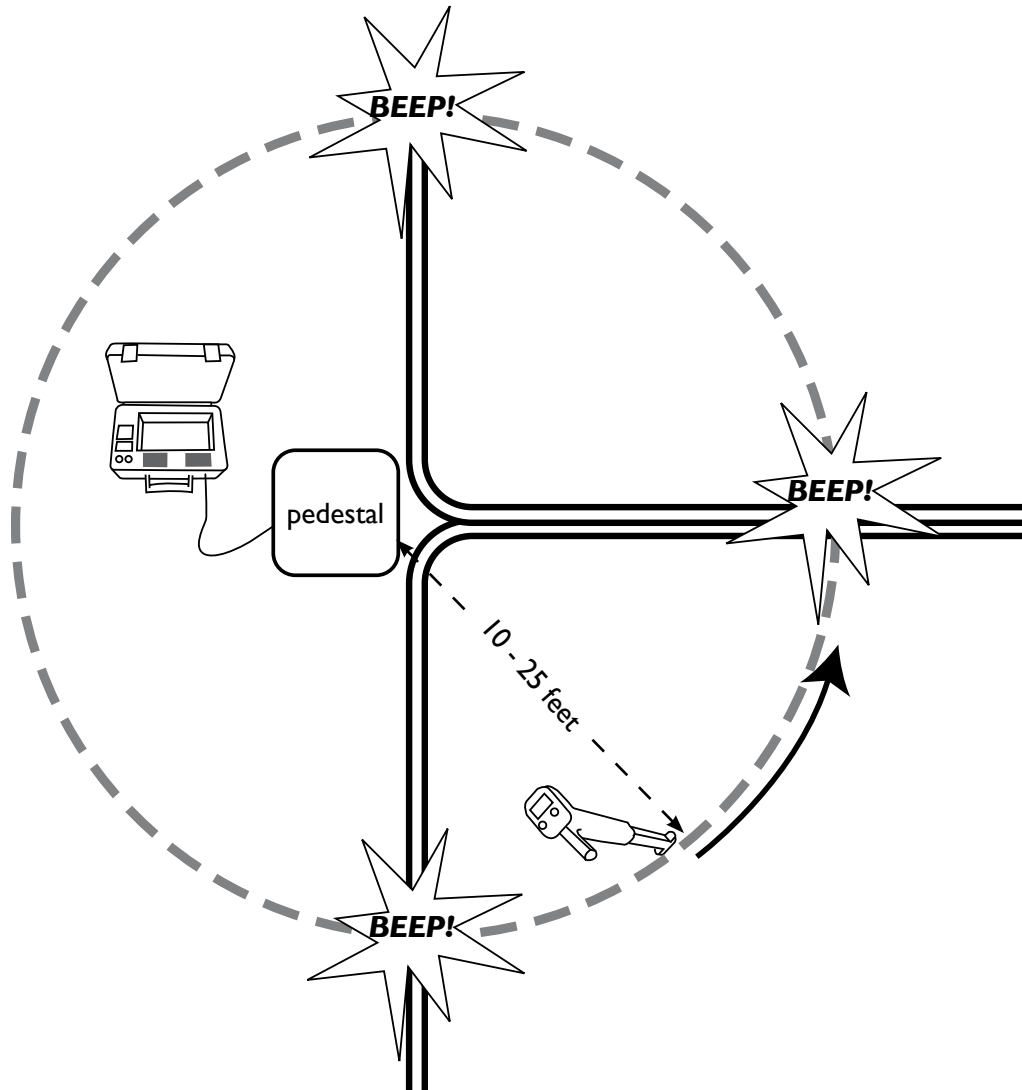

5

MAGNETIC LOCATING

Theory of Operation:

Magnets can be defined as bodies that produce external magnetic fields; these fields are bipolar, that is, they will have a positive pole where the field emanates from the object and a negative pole where the field returns. The shape and size of this external field is directly related to the magnet's strength.

Magnetic locators work by detecting the two types of magnetization that can be produced by underground ferrous (iron or steel containing) objects. The first type is the weak field induced naturally by Earth's magnetic field. All ferrous objects have this field, and in the Northern Magnetic Hemisphere this field is always positive. The second type is an artificially induced permanent magnetization. When this type of field is present, it is usually quite strong. The field orientation varies depending on how the object was magnetized.

Magnetic locators have two sensors vertically separated about 8 to 20 inches that give a reading when the two sensors are detecting different magnetic field strengths. So when the lower sensor (typically) is near a ferrous object, it will detect a stronger field than the upper sensor and trigger a response, which is usually an audio signal rising in pitch but can also be a numeric indication or bars on a screen.

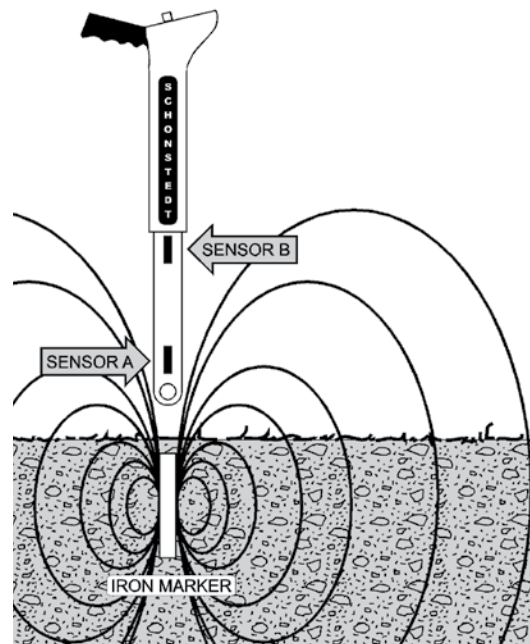

Searching with a Magnetic Locator:

Begin with the sensitivity control set to normal. Be aware of metal on your person that can distort readings, such as wristwatches or steel toed boots - you may want to remove these or hold them away from the locator. Sweeping the locator from side to side is the most generally useful way to cover a large area - when the locator comes close to a ferrous object you will get a response.

If your locator has a visual display that distinguishes between positive and negative polarity, you can often tell if you have found a vertically or horizontally oriented pipe. If vertical, the reading will be either positive or negative and will not have a corresponding and opposite reading nearby. If two or more vertical pipes are buried close to each other, they will usually produce similar polarity readings. If horizontal, the polarity reading will be negative at one end of the pipe, positive at the other end, and significantly weaker between the two ends.

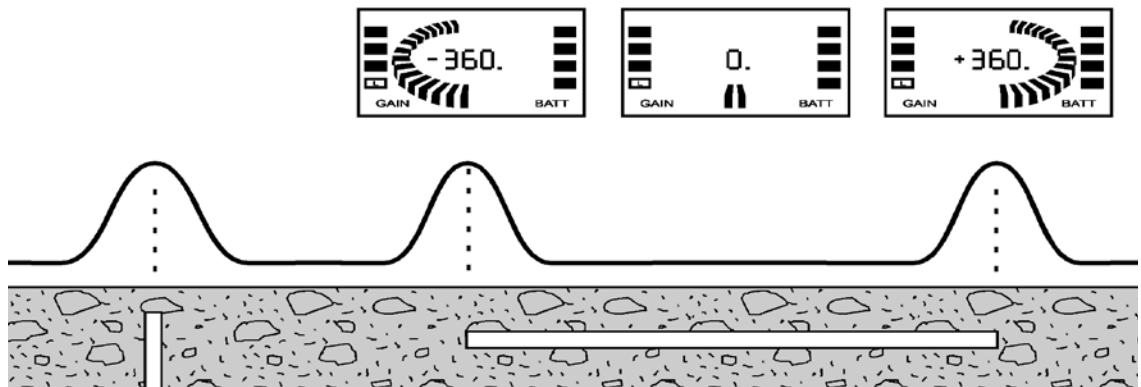

Pinpointing an Object:

Once you have detected an object by sweeping, you can locate it more precisely by slowing down and holding the locator vertically over the reading. Move the locator in an 'X' pattern and home in on the strongest response in both directions. The 'X' pattern will pinpoint the ends of large objects, and the exact location of small objects.

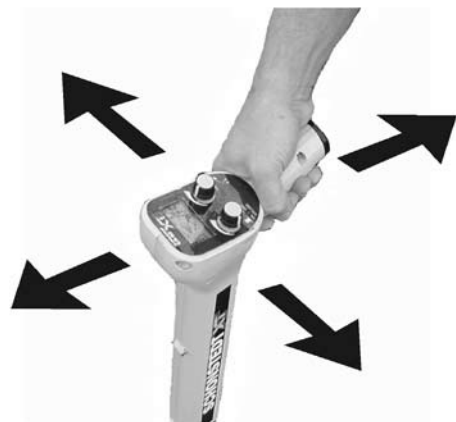

Adjusting Sensitivity:

Sensitivity to underground objects can be reduced in two ways: raising the locator several inches, or reducing the gain control. Raising the locator can give valuable information regarding the size of the underground object. If the object is small, such as a bolt or nail, the signal will decrease quickly as the locator is raised. But the signal will decrease much more gradually if the object is large, such as a length of rebar used as a survey marker. Most magnetic locators can detect an 18 inch section of rebar buried as deep as seven feet.

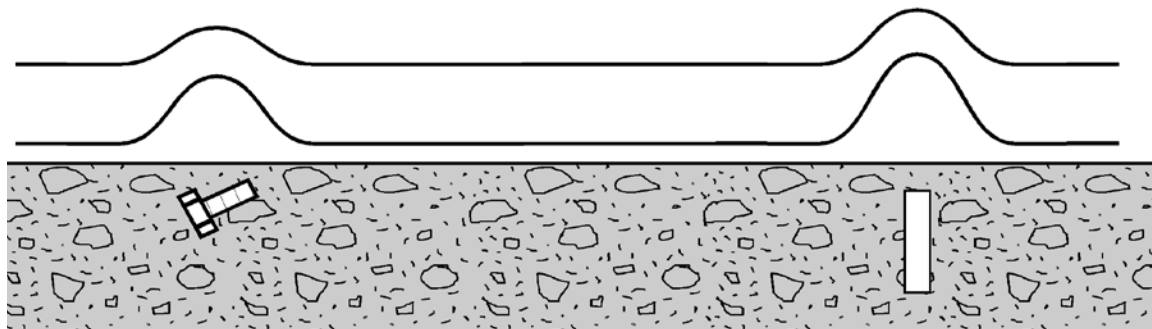

Strongly Magnetized Markers:

When a ferrous object with a very strong field is near the surface there will be a peak signal directly over the object, but there will also be weaker but still distinct signals on both sides of the marker that could be mistaken for separate objects. Referring to the illustration on page 45, the heavy line shows the characteristics of all three readings. From A to B and from C to D, there is a smooth, gradual increase and decrease in signal strength, while from B to C there is a much more abrupt rise and fall in signal strength, with a stronger peak response. The weak signals on either side of the object are due to the locator's extreme sensitivity to aspects of the magnetic field parallel to its (the receiver's) vertical axis. At points B and C the magnetic field intersects this axis perpendicularly, reducing the difference in readings between the two sensors.

The best way to avoid being fooled by these weaker but distinct signals is to sweep well before pinpointing.

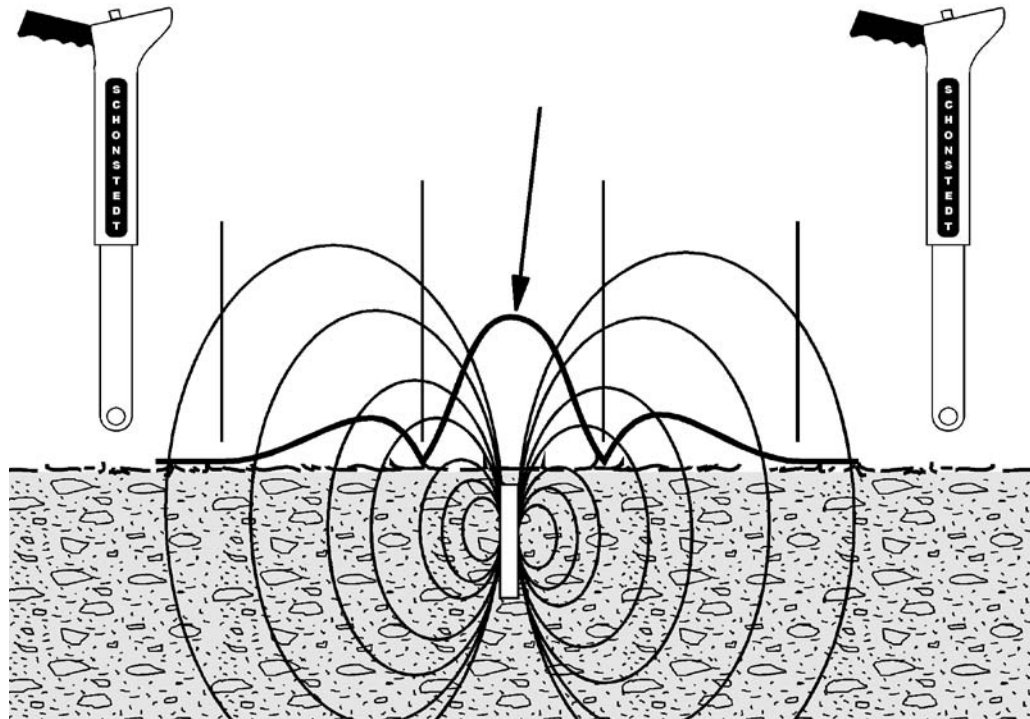

How to Search Near a Chain Link Fence:

To search near a chain link fence, reduce the gain setting and hold the locator horizontally, as shown in the illustration, with its long axis at right angles to the fence - this keeps the 'upper' sensor away from the fence. Search by sweeping the locator side to side as well as forward and back. By this means you can search a swath several feet wide along the base of the fence.

When the 'lower' sensor - which is a few inches from the end of the locator and should be the sensor closest to the fence - is directly over a ferrous object there will be a sudden drop in signal strength. As you move the



lower sensor away from the object, response will rise just as abruptly.

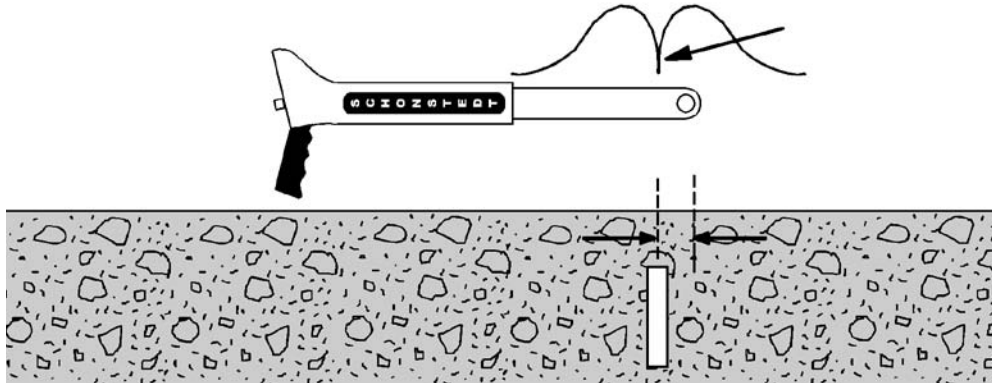

Locating Metallic Pipe:

Long ferrous objects, such as pipe, have magnetic fields that reach out beyond their ends. In the case of metallic pipe, this even applies to pipe sections that have been welded together - there will be peak readings at the welded joints.

When tracing pipe, set the gain at maximum and hold the locator between one and two feet above ground level. Holding the locator

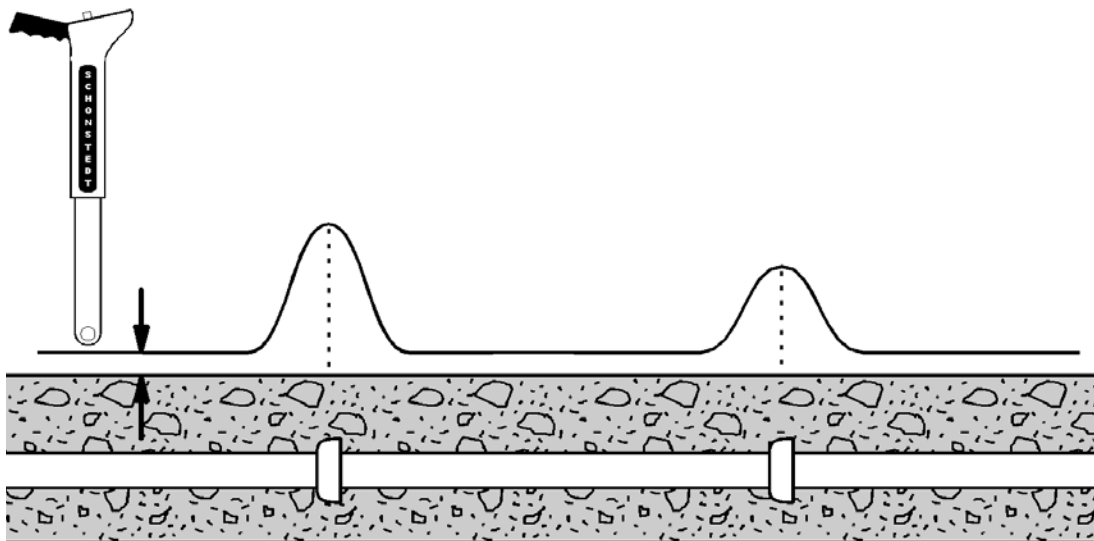

steady, walk along the suspected pipe's path, making temporary marks at any readings - don't try to pinpoint yet. When you have several marks in your area of concern, reduce the gain for a second pass and hold the locator closer to the ground, pinpointing the peak response near the previously marked points. These marks at peak response will reveal the pipe's location. Magnetic locators can get a signal from four inch pipe set as deep as eight feet.

How to Locate in Cluttered Areas:

One approach to searching in cluttered areas is to sharply reduce the locator's sensitivity before sweeping. The locator will not detect smaller objects, but will still respond to larger objects. To find very large objects, such as steel cisterns or tanks, you can raise the locator several feet above ground level. Small objects near the surface will not be detected, but deep, very large objects will.

When locating rebar in concrete, keep in mind that readings will be strongest at rebar ends, but also consider that steel ties at rebar intersections will also give strong readings.

Points to Keep in Mind When Using a Magnetic Locator:

- Magnetic locators will only detect magnets or ferrous (iron containing) objects, including but not limited to rebar, magnets, pipes, weapons, ordnance, old tin cans, bolts, PK nails, etc.
- Joints in pipe will be detected, even welded joints.
- Some large non-ferrous objects, such as septic tanks, may have metal components, such as handles, that can be located.
- Energized power lines, 50/60 cycle, will give a reading with an easily recognizable 'warble'.
- Magnetic locators can detect magnetic fields 'through' any non-magnetic material, including snow and water, just as well as they can through dirt or concrete. But do not hold the locator in water as the water may damage the sensors or electronics.
- When performed skillfully, magnetic locating can detect an object as small as a PK nail, within a circle as tight as 1/2".
- Non-ferrous metallic objects, such as gold rings, copper wire, aluminum cans or silverware, will not be detected.

Schonstedt Instrument Company

100 Edmond Road

Kearneysville, WV 25430

304-725-1050

800-999-8280

www.schonstedt.com

SCHONSTEDT 
INSTRUMENT COMPANY
Making Locating Easier Since 1953