

Boomerang: Real-Time I/O Meets Legacy Systems

Ahmad Golchin
Computer Science Department
Boston University
Boston, USA
golchin@cs.bu.edu

Soham Sinha
Computer Science Department
Boston University
Boston, USA
soham1@cs.bu.edu

Richard West
Computer Science Department
Boston University
Boston, USA
richwest@cs.bu.edu

Abstract—This paper presents Boomerang, an I/O system that integrates a legacy non-real-time OS with one that is customized for timing-sensitive tasks. A relatively small RTOS benefits from the pre-existing libraries, drivers and services of the legacy system. Additionally, timing-critical tasks are isolated from less critical tasks by securely partitioning machine resources among the separate OSes. Boomerang guarantees end-to-end processing delays on input data that requires outputs to be generated within specific time bounds.

We show how to construct composable task pipelines in Boomerang that combine functionality spanning a custom RTOS and a legacy Linux system. By dedicating time-critical I/O to the RTOS, we ensure that complementary services provided by Linux are sufficiently predictable to meet end-to-end service guarantees. While Boomerang benefits from spatial isolation, it also outperforms a standalone Linux system using deadline-based CPU reservations for pipeline tasks. We also show how Boomerang outperforms a virtualized system called ACRN, designed for automotive systems.

Index Terms—Partitioning hypervisor, real-time operating system, composable task pipelines, input/output

I. INTRODUCTION

Mixed-criticality systems require the spatial and temporal isolation of tasks to meet timing, safety and security constraints [1]. Additionally, these systems involve real-time task pipelines to implement sensing, processing and actuation. For example, an automotive system supports low-criticality infotainment services, which must be isolated from highly critical driving assistance tasks that process sensor data to avoid vehicle collisions.

Spatial isolation ensures that one software component cannot alter another component’s private code or data, or interfere with the control of its devices. Temporal isolation ensures that a software component cannot affect when another component accesses a resource (e.g., a CPU). Lack of temporal and spatial isolation leads to potential timing or functional failures. Failure of a highly critical task has potentially catastrophic consequences, while failure of a low-criticality task has less significant consequences.

One way to support mixed-criticality systems is to partition tasks onto separate hardware. This ensures less critical tasks are unable to directly affect those of greater importance. Automotive systems have traditionally taken this approach, by assigning a different functional component to a separate electronic control unit (ECU) [2]. However, as the complexity of these systems increases, hardware costs, wiring and packaging

become prohibitive. For this reason, new hardware platforms that integrate the functionality of multiple hardware components, including multicore processors, accelerators, GPUs, and various input/output (I/O) interfaces are now emerging. Tesla’s AutoPilot 2.x, for example, already uses platforms such as the Nvidia Drive PX2 in its cars, to assist with vehicle control.

An integrated solution, combining tasks of different criticality levels on the same hardware, requires an operating system to correctly enforce temporal and spatial isolation. Partitioning operating systems such as Tresos [1] and LynxOS [3] have been developed for automotive and avionics systems, respectively, in accordance with standards such as AUTOSAR [4] and ARINC653 [5], to isolate tasks of different criticality levels. However, these types of systems are not able to take advantage of legacy software, including libraries and device drivers written for the newest hardware. In contrast, systems such as Linux, Windows and OS X are regularly updated with features that would take an operating system developer years to reproduce in a clean-slate design. Unfortunately, general purpose systems lack the necessary temporal and spatial requirements, including the ability to perform real-time sensing, processing and actuation required by emerging mixed-criticality systems.

In this paper, we present a system called Boomerang. Boomerang uses a partitioning hypervisor [6], which separates the hardware of a physical machine into different guest domains that *directly* manage their assigned resources. This contrasts with a conventional *multiplexing* (or consolidating) hypervisor, which intervenes in the sharing of physical machine resources among multiple guests. Boomerang’s approach removes the hypervisor from resource management, once CPU cores, physical memory and I/O devices are assigned to separate guests.

Using separate partitions, Boomerang supports the co-existence of a real-time operating system (RTOS) and a legacy system such as Linux. Rather than treating these systems as separate guests, Boomerang establishes a tightly-coupled *symbiotic relationship*, such that the RTOS is empowered with legacy features, and the legacy system is empowered with real-time capabilities. For example, a Boomerang Linux partition might support OpenGL and CUDA libraries for hardware accelerators, camera devices, and machine learning algorithms, which would be difficult to write and certify for an RTOS. Likewise, the RTOS partition in Boomerang provides the timing guarantees for real-time tasks to perform sensor data

processing and actuation.

Key to this paper’s contributions is the construction of a *composable tuned pipe* abstraction. This abstraction implements real-time task pipelines that ensure end-to-end guarantees on sensing, processing and actuation, spanning both RTOS and legacy OS services. Boomerang extends prior work on tuned pipes between a USB device and a task running in the same OS [7] to encompass task pipelines spanning an RTOS and another guest. The aim is to show that Boomerang is able to combine legacy and real-time services in a way that ensures information flow is bounded by throughput, loss and delay constraints.

As stated above, many emerging mixed-criticality systems require tasks to process sensory inputs before subsequently generating outputs that affect the actuation of a device. For example, a cruise control system in an electric car may collect data from cameras and speed sensors before determining that the motors need to change speed to keep a safe distance to the vehicle ahead.

Novel to Boomerang’s composable tuned pipes is the ability for an integrated RTOS based on Quest [8] to manage I/O that requires services in a legacy system such as Linux. We show how to construct composable task pipelines in Boomerang that combine tasks spanning Quest and a legacy Linux system. By assigning time-critical I/O to Quest, Boomerang ensures that complementary services provided by Linux meet end-to-end timing guarantees. We compare Boomerang to a standalone Linux system, using specific cores to handle timing-sensitive I/O. Boomerang not only benefits from spatial isolation, it also outperforms a standalone Linux system using deadline-based CPU reservations for pipeline tasks. We also show how Boomerang outperforms a partitioning hypervisor called ACRN, designed for automotive systems.

The following section provides background to the problem addressed by Boomerang. Section III describes the Boomerang partitioning hypervisor and composable tuned pipes. An evaluation of Boomerang is described in Section IV. Related work is discussed in Section V. Finally, conclusions and future work are described in Section VI.

II. BACKGROUND

Boomerang supports composable task pipelines that form a round-trip path, originating from a device input and ultimately finishing with a device output. It is designed specifically for applications that require sensing, processing and actuation.

Figure 1(a) shows the round-trip path in a typical OS. A device acknowledges the completion of an I/O request by generating an interrupt. Most systems handle interrupts at priorities above those of software tasks. They also incorrectly charge interrupt handling to the task that was preempted by the arrival of the interrupt. Worse still, a burst of interrupts within a short time may delay a time-critical task enough to miss its deadline [8], [9].

Figure 1(a) uses a dedicated core for I/O handling of device interrupts, to avoid interference with task execution. However,

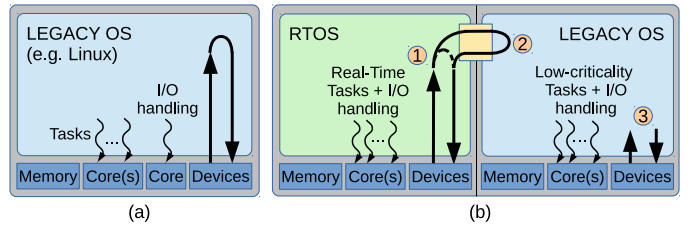

Figure 1: (a) Round-trip I/O in a single OS, and (b) possible I/O paths in a Boomerang partitioning hypervisor.

the single OS approach does not provide adequate spatial isolation of tasks of different criticalities, and underutilizes the core exclusively used for interrupt handling. If the OS malfunctions then tasks of all criticalities are potentially compromised. In contrast, Figure 1(b) shows how Boomerang supports three different classes of I/O using a partitioning hypervisor [10], [11] to separate highly critical timing sensitive operations from less critical system components using different guest OSes.

In the first case (shown with a dashed line), all I/O is contained within the RTOS. Real-time tasks and interrupt handlers for device I/O share the same processor cores, as the RTOS ensures predictable timing guarantees on task and I/O processing.

In the second case, the I/O path traverses a task pipeline that enters into a legacy OS via secure shared memory. Here, the legacy OS provides services that would require significant effort to port to the RTOS. The round-trip I/O path in case 2 is still able to meet end-to-end timing guarantees because the tasks in the legacy OS are isolated from timing unpredictability caused by interrupts. This is possible by demoting interrupts (in the legacy OS) to priorities that are distinctly lower than those of tasks. Additionally, legacy OSes such as Linux support `SCHED_DEADLINE` execution for tasks, thereby ensuring some degree of timing guarantees, as long as there is no interference from interrupts [7].

In the third case, it may be necessary for some I/O to be handled by a legacy system, which has drivers and libraries that are unavailable in the RTOS. For example, a series of cameras used in a driverless car need suitable device drivers and machine learning algorithms to perform object classification. The outcomes of object classification dictate whether information needs to be communicated to the RTOS to issue real-time outputs that adjust vehicle motion. As with the single OS approach, I/O originating in case 3 may handle interrupts on a dedicated core, to avoid interference with tasks that serve RTOS requests in case 2. Alternatively, I/O processing in the legacy OS is given lower priority than task execution, leaving critical I/O to the real-time OS.

A. VCPU Scheduling

Boomerang’s partitioning hypervisor allows each guest to directly manage its assignment of physical CPUs (PCPUs)¹. This differs from a traditional hypervisor, which schedules

¹A PCPU is either a processor core, hardware thread, or individual CPU.

guest threads on virtual CPUs (VCPUs) and then maps those onto PCPUs. Instead, Boomerang’s guest RTOS implements its own VCPU scheduler using the PCPUs available to it, without any need for additional scheduling in the hypervisor. At the same time, other guests running on Boomerang schedule threads directly on their available PCPUs.

Boomerang uses the Quest RTOS [8] to assign a processor capacity reserve [12] to each VCPU. Each reserve has a budget capacity, C , and period, T . A VCPU is required to receive at least C units of execution time every T time units when it is runnable, as long as a schedulability test [13] is passed when creating new VCPUs. This way, the Quest scheduler guarantees temporal isolation between threads associated with different VCPUs.

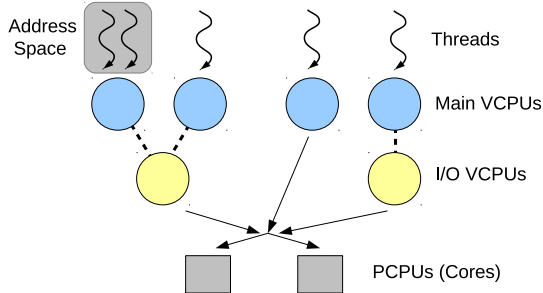

Figure 2: VCPU scheduling hierarchy in Quest.

Figure 2 shows the scheduling of threads and VCPUs for real-time tasks and interrupt handlers. Tasks are assigned to *Main VCPUs*, and separate *IO VCPUs* are used for interrupt handling. Main VCPUs are implemented as Sporadic Servers [14]. Each Sporadic Server keeps track of its VCPU’s budget usage, and constructs a list of timestamped future replenishments, to ensure timing guarantees. By default each Sporadic Server VCPU is scheduled using Rate-Monotonic Scheduling (RMS) [15], although an alternative policy such as earliest-deadline first (EDF) may be chosen. With RMS, the VCPU with the smallest period, T , has the highest priority.

To ensure that tasks are isolated from interrupts, Quest promotes interrupt handling to a schedulable thread context, whose execution is charged to an IO VCPU. Each IO VCPU is associated with the Main VCPU that led to the occurrence of the interrupt. Such occurrences result from tasks issuing blocking requests (e.g., via a `read()` system call), or a system thread awaiting a kernel event.

Consider a task that issues a blocking I/O request on a device (e.g., USB interface). When the task blocks, it stops charging execution time to its Main VCPU. Some time later an interrupt occurs when an I/O transfer is complete. This causes a *top half* handler to execute, which determines the Main VCPU waiting on I/O. The top half then inserts into a system ready queue an *IO VCPU* with a dynamically calculated budget and period, based on the parameters of its corresponding Main VCPU. Finally, the interrupt is acknowledged, and all subsequent handling occurs in a *bottom half* thread context, when the corresponding IO VCPU is scheduled. Consequently,

all bottom half execution time is charged to its IO VCPU before the blocked task resumes execution on its Main VCPU.

Each IO VCPU in Quest is given a utilization bound, U_{IO} . There is one IO VCPU for each device class, with classes existing for USB, networking, ATA, and GPIO devices, among others. When an IO VCPU is added to the scheduler ready queue, its budget is set to $U_{IO} \times T_{Main}$ and its period is set to T_{Main} , where T_{Main} is the period of the Main VCPU of the source entity associated with the interrupt. Quest is then able to correctly schedule bottom half interrupt handlers at the priority of the source task running on a Main VCPU. This contrasts with systems such as Linux, which schedule bottom halves (a.k.a., tasklets or softirqs) at priorities that are not tied to the source of corresponding interrupts.

IO VCPUs have a dynamically calculated budget and period based on the Main VCPUs they serve, to avoid the overhead of maintaining replenishment lists for short-lived interrupt service routines (ISRs). This budget is eligible for use as long as the sustained IO VCPU’s utilization does not exceed U_{IO} . This policy is shown to be effective for short-lived interrupt service routines (ISRs), which would fragment a Sporadic Server budget as used for Main VCPUs.

Quest requires reprogramming of hardware timers in *one-shot* mode, to determine the next system event. This is similar to Linux’s tickless operation. As IO VCPUs only have *one budget replenishment* to consider, rather than a list, this leads to reduced timer reprogramming overhead.

B. Communication Model

Data flow involves a pipeline of communicating tasks. Each task processes its input data to produce output, either for devices or subsequent tasks in the pipeline. This leads to a communication model characterized by: (1) the interarrival times of tasks in the pipeline, (2) inter-task buffering, and (3) each tasks’ access pattern to communication buffers.

Task Interarrival Times. Each task ordinarily samples input data periodically. However, a task will block if data is unavailable, leading to aperiodic or irregular intervals between successive task instances. Either way, a task pipeline’s timing requirements assume that data will propagate with a minimum inter-arrival time between tasks.

Register-based versus FIFO-based Communication. A FIFO-based shared buffer is used in scenarios where *data history* is an important factor. However, in sensor-data processing the most recent data is often more important. For example, a driving assistance system should always compute outputs that affect vehicle dynamics from the latest sensor data. FIFO-based communication results in loosely synchronous communication: the producer is suspended when the FIFO buffer is full and the consumer is suspended when the buffer is empty. Register-based communication achieves asynchrony between two parties using Simpson’s four-slot algorithm [16].

Implicit versus Explicit Communication. Explicit communication allows access to shared data at any time during a task’s execution. This might lead to data inconsistency in the presence of task preemption. Conversely, the implicit

communication model [17] essentially follows a read-before-execute paradigm to avoid data inconsistency. It mandates a task to make a local copy of the shared data at the beginning of its execution and to work on that copy throughout its execution.

Boomerang supports both periodic and aperiodic tasks. It also supports both register- and FIFO-based communication. Implicit communication is enforced for data consistency.

III. BOOMERANG

The Boomerang partitioning hypervisor divides processor cores, physical memory and I/O devices among guest domains. Each guest manages its physical resources *without* involvement of the hypervisor. This has two important properties: (1) the hypervisor is only used to bootstrap the system and to establish secure communication channels between guests using hardware extended page tables (EPTs)², and (2) the hypervisor is removed from runtime management of physical machine resources, making its trusted code base extremely small.

Boomerang’s partitioning hypervisor has a text segment of less than 4KB, although more space is needed for EPTs (e.g., 24KB for a 4GB guest). Given the hypervisor is not accessed under normal guest operation, the system’s most privileged *ring of protection* is less susceptible to security attacks than a conventional OS image running directly on hardware. In the latter case, system calls must pass control to the OS kernel, whereas in Boomerang these are restricted to the local guest.

Unlike traditional hypervisors that *multiplex* guests onto the same shared physical machine, partitioning hypervisors offer opportunities for applications that require security and timing predictability. Hardware virtualization features isolate guests, using an additional ring of protection reserved for the hypervisor. At the same time, time-critical guests are able to run real-time resource management policies without being compromised by additional resource management policies in the hypervisor.

We see partitioning hypervisors as being suitable for mixed-criticality systems, requiring spatial and temporal isolation of application tasks and software components according to different system criticality levels. For example, automotive systems adhering to standards such as ISO 26262 [18] are required to meet specific functional safety requirements, according to several classes of *automotive safety integrity levels* known as ASIL A-D. Software certified to ASIL D standard operates at the most stringent safety level, where the risk of failure is potentially life threatening. In contrast, ASIL A applies to software that has a very low probability of significant human injury even during failures. Other standards such as ARINC 653 and DO-178B have similar requirements for avionics systems. For these types of systems, it is possible to assign software to machine partitions according to their safety integrity levels.

²Intel processors with VT-x capabilities refer to these tables as EPTs. AMD-V processors have similar nested page tables (NPTs).

A. Composable Tuned Pipes

Figure 3 shows a logical representation of a single *tuned pipe* (a.k.a., *tpipe*). A pipe has one *pipe processor* and two *endpoints*, with one endpoint for input and the other for output. A pipe processor is represented by a VCPU, guaranteeing at least C units of execution time every T time units when runnable. Pipe processors are associated with tasks bound to Main VCPUs, or threaded interrupt handlers bound to I/O VCPUs.

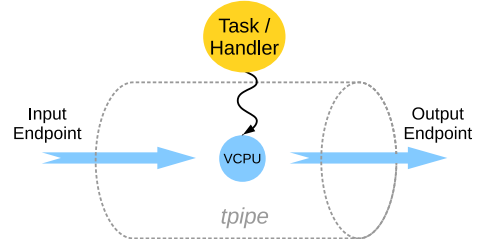

Figure 3: A tuned pipe.

A tuned pipe guarantees data flowing from an input to an output endpoint is processed according to specific service requirements. These requirements apply end-to-end, through a *pipeline* of one or more tuned pipes. If the pipeline is lossless, it ensures specific throughput and delay guarantees, whereas if it is lossy, it guarantees a maximum fraction of lost data while meeting delay bounds.

Boomerang maintains a local repository for each guest OS (a.k.a., sandbox or machine partition), which stores information about available endpoints. The repository records a globally unique identifier for each endpoint, in the form: *hostID:sandboxID:asID:epID*. This distinguishes endpoints in different host machines (by *hostID*)³, sandboxes (by *sandboxID*), and address spaces (by *asID*). Access capabilities restrict which tuned pipes are able to connect to endpoints.

The rules controlling connectivity to endpoints are a topic of ongoing research. They have implications for secure information flow analysis [19]–[21], which is outside the scope of this paper. Notwithstanding, pipelines may be constructed within a single address space, between address spaces in the same machine partition, between different partitions on the same host, and across different hosts.

When creating a tuned pipe, Boomerang automatically calculates (i.e., *tunes*) the budget and period of the pipe VCPU to ensure end-to-end guarantees are met. Tuned pipes are created with a call to *tpipe()*, as follows:

```
tpipe_id_t tpipe(ep_t *inp[], int n_inp, ep_t *outp,
                qos_t spec, tpipe_task_t func, void* arg);
```

The input endpoint of the new tuned pipe specifies an array of pointers, *inp*, to endpoint types. This array identifies the endpoint addresses of *n_inp* inputs to the tuned pipe, along with the buffering semantics of each input, which will be discussed in Section III-B.

³In this paper, we restrict communication within the same host machine.

Data flowing into the tuned pipe is processed by a specific callback function (`func`), which sends its output to specific destinations connected to the output endpoint, identified by `outp`. The callback function takes an optional argument (`arg`), and runs in its own thread context. The thread context defines a task, which is bound to a VCPU having an automatically-generated budget, C_i , and period, T_i , for the tuned pipe, $tpipe_i$. The budget and period are derived from the quality-of-service (QoS) requirement (`spec`) for end-to-end throughput and delay on data processing. This requirement must also satisfy the schedulability of all VCPUs on a given physical CPU (PCPU), otherwise the tuned pipe is not created. If a tuned pipe is successfully created, it is given a unique ID within its guest OS.

$tpipe_i$ requires its callback function to process data from one or more input endpoints and produce output in one quantum of size C_i , every period, T_i . Functions are selected from a predefined repository of callbacks. Each callback has a known worst-case execution time (WCET) based on pre-profiled timing information to handle a maximum I_i inputs and produce up to O_i outputs in one quantum. The actual amount of processing in a quantum depends on the availability of data in input buffers, and how many outputs need to be written.

Each function in the repository declares the allowable buffering capabilities for its inputs and outputs. Any tuned pipe connecting to another with a function that does not match the allowed buffering capabilities is rejected.

B. POSIX Pipes versus Tuned Pipes

Similarities exist between a pair of tuned pipes and a single POSIX pipe. The latter provides a shared memory buffer that is accessible to a group of communicating threads via file descriptors. The file descriptors describe the endpoint capabilities, including whether the pipe is readable or writable.

A tuned pipe pair in Boomerang differ from a POSIX pipe by capturing the timing requirements for data processing and communication. They also define the buffering semantics for I/O endpoints. Two pipes, $tpipe_i$ and $tpipe_j$ are composed by connecting the output endpoint of $tpipe_i$ to the input endpoint of $tpipe_j$. Boomerang allows the composition of two or more pipes to support either asynchronous (RT_ASYNC) or semi-asynchronous (RT_FIFO) communication, as shown in Figure 4.

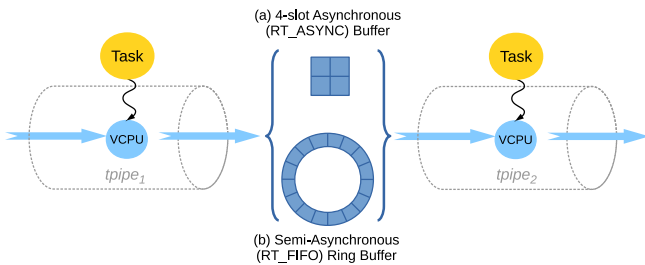

Figure 4: A two-stage pipeline with (a) 4-slot asynchronous buffering, and (b) semi-asynchronous ring buffering.

With RT_ASYNC, Simpson’s Four Slot buffering scheme [16], [22] is used to allow the two pipe threads to execute independently of each other. Four Slot communication guarantees *freshness* and *integrity* of data objects exchanged between a producer and consumer, without the sender or receiver ever having to block. Freshness guarantees the most recent value of a data object is made available. Integrity ensures a data object is not partially updated before the previous object has been read in entirety.

With RT_FIFO, a ring-buffer is established between the communicating pair of pipes to avoid data loss. However, the sender must block when the buffer is full, and the receiver must block when the buffer is empty. This places a timing dependency on producers and consumers, which potentially violates end-to-end timing guarantees unless data flow rates are managed correctly.

C. Device versus Task Pipes

Boomerang’s RTOS provides a pre-defined set of tuned pipes for all devices involved in real-time I/O. A *device pipe* features an IO VCPU for interrupt handling, and an optional Main VCPU for endpoint buffer management of shared devices. Sharing requires scatter-gather functions to move data between the device endpoint buffer and pipe-specific buffers of *task pipes*. If a device is not shared, its handler directly accesses the buffer of a specific task pipe.

The `tpipe()` call, described earlier, creates a *task pipe*. Unlike a device pipe, there is no IO VCPU for interrupt handling. Task pipes form pipelines between device pipes that act as the sources and sinks of input and output data, respectively.

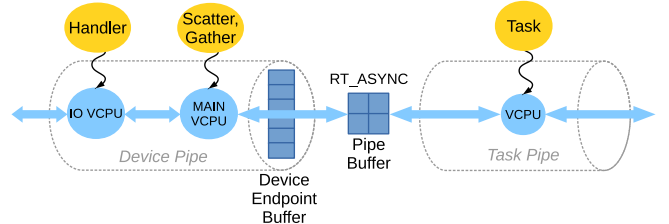

Figure 5: Example composition of a device and task pipe for asynchronous I/O.

Figure 5 shows an example composition of a device and task pipe for asynchronous (non-blocking) I/O communication. The device is assumed to be shared with other tasks. If a task requires semi-asynchronous device communication for blocking I/O, it would replace the four slot pipe buffer with a ring buffer.

D. Pipeline Construction

Pipelines of tuned pipes are constructed in the order in which data flows, from input to output. A tuned pipe is responsible for the creation of all buffers that connect to its input endpoint. It also declares its output endpoint, which includes a count of the number of outputs it handles. A

pipeline is incomplete until all I_i inputs and O_i outputs of each $tpipe_i$ are connected.

The output endpoint of each task pipe has a connection to a default device pipe, which could be a null device. A system call interface allows this output endpoint to be redirected to one or more different device pipes.

Once fully connected, the system activates the pipeline by allowing each $tpipe$ task to be scheduled for execution. Those tasks that execute in the RTOS are runnable when they have available budgets on their corresponding VCPUs. Tuned pipe tasks that execute in Linux are runnable when they have available budgets in their `SCHED_DEADLINE` scheduling class. Linux’s `SCHED_DEADLINE` scheduling class uses a Constant Bandwidth Server [23] to limit the maximum CPU bandwidth consumed by a task within a specific period. The end of the period is used to define the task deadline, and all tasks are scheduled earliest deadline first. However, interrupt handlers are not managed in this scheme.

Boomerang runs our in-house RTOS in one sandbox, and Linux in another sandbox on the same physical machine. A Linux kernel module maps a secure shared memory region by calling into the hypervisor. The hypervisor uses EPTs to map machine physical memory into each sandbox so they are able to communicate.

Each sandbox is equipped with kernel services that manage a local repository of endpoints and tuned pipes. Communication services allow queries to a remote sandbox, to discover endpoints and to connect or disconnect from tuned pipes. Mailbox channels are established by Boomerang to enable OSes in different sandboxes to send remote OS requests. Access policies determine whether address spaces in the local or remote sandbox are able to connect to endpoints of existing tuned pipes.

Boomerang’s RTOS provides a remote shell to Linux through inter-sandbox shared memory. Linux uses a kernel module to allow user-space application programs with root privilege to execute shell commands on the RTOS. A shell interface allows pipelines of tuned pipes to be constructed. The RTOS is able to query endpoints and tuned pipes that exist in Linux, and issue requests to connect to them via `tpipe()` calls.

After the construction of the pipeline, the RTOS runs an end-to-end throughput and delay analysis. If the end-to-end requirements are met for the pipeline, the transmission of data is allowed to begin from the RTOS. Tuned pipe functions synchronize their start and end of operation lifecycle using Start-Of-Task and End-Of-Task packets on their input endpoints.

The following example illustrates a pipeline specification:

```
[*](A | B), C | D | E, F [e2e_tput | loss_rate, e2e_delay]
```

The resultant pipeline is shown in Figure 6. Boomerang’s repository of tuned pipe functions requires that A and C connect to a device output endpoint for reading, while E and F connect to a device input endpoint for writing.

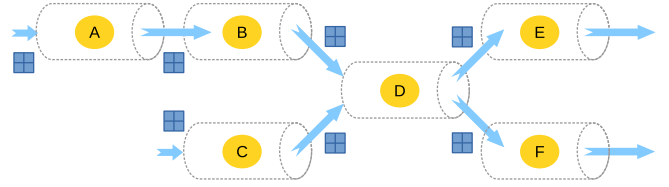

Figure 6: An example pipeline with multiple inputs & outputs.

Boomerang defaults to non-blocking tuned pipe semantics, where data freshness is more important than lossless communication. Figure 6 shows four-slot buffering of all pipeline stages. If lossless communication is required, the entire pipeline specification is preceded by an asterisk. This pipeline would then use FIFO buffers between each pair of tuned pipes.

With four-slot buffering, the entire pipeline has an optional end-to-end service specification in terms of tolerable $loss_rate$ and $e2e_delay$. With FIFO buffering, the pipeline is specified with an optional end-to-end throughput, $e2e_tput$, and delay. The throughput is measured as the minimum number of *data objects* per unit time exiting a final tuned pipe, while the delay is measured in microseconds. Each data object represents a message, which is the size of one slot of either a four-slot or FIFO buffer.

If the QoS specification is omitted, then the pipeline defaults to best effort. In such case, the VCPUs of each tuned pipe revert to their default values. If the pipeline overloads the PCPUs to which it is assigned, leading to an infeasible schedule, its VCPU periods are repeatedly extended until the pipeline is schedulable.

The shell interpreter allows parallel sections of a pipeline to be defined by comma-separated lists of tuned pipes. Here, the pipeline section $A | B$ runs parallel with C . This could be representative of two separate input sensor streams coming from two different devices. Parentheses ensure correct grouping of pipeline sequences, while two tuned pipes are connected using the shell vertical bar symbol (`|`).

In the example, the outputs of B and C feed into the single tuned pipe, D . Similarly, the output of D is split across E and F . D might represent a sensor fusion and control task, while E and F might be specific actuator tasks that output their data to different devices. In an automotive system, for example, E and F might send their outputs to two different CAN buses, managed by device pipes.

The $e2e_delay$ constraint applies to the longest path through the pipeline, while for FIFO-buffered communication the $e2e_tput$ applies to whichever final task pipe has the lowest rate of output. If FIFO-buffering were used in the figure, whichever of E and F had the lowest output rate would dictate the end-to-end throughput.

As a four-slot buffered pipeline allows each tuned pipe to read and process whatever data sits in its input buffers, it is possible that new data has overwritten old data before the consumer runs. This happens if the producer has an arrival rate, $\lambda = 1/T_p$, greater than the consumer’s service rate, $\mu = 1/T_c$. Here, it is assumed that T_p and T_c are set to ensure

one message transfer every corresponding period, regardless of whether it is a new message or not.

E. End-to-end QoS Guarantees

Given a pipeline of tuned pipes and buffers, Boomerang runs a constraint solver to determine C_i and T_i for each $tpipe_i$. The function executed by $tpipe_i$ is assumed to process at least one of its I_i inputs and generate one of its O_i outputs every period, T_i . Essentially, one or more processed data *messages* propagate through a tuned pipe within C_i execution time. Boomerang assumes that C_i is derived by pre-profiling the WCET of the corresponding task function. This WCET is then stored in the local repository, along with the set of inputs and outputs used by the function.

For a pipeline to successfully meet its end-to-end timing requirements, Boomerang must still determine each period, $T_i \mid T_i > C_i$, and possibly scale each service time C_i to forward more than one message at a time. It follows that a FIFO buffered pipeline successfully meets its end-to-end timing requirements if:

- 1) $\sum_{i \in l} T_i \leq e2e_delay$, for the longest path l ,
- 2) $\min_{\forall i} \{ \frac{m_i}{T_i} \} \geq e2e_tput$, where $m_i \geq 1$ messages are transferred by $tpipe_i$ every C_i ,
- 3) all FIFO buffers are sized to ensure no additional blocking delays of tasks, and
- 4) all task scheduling constraints are satisfied on their respective PCPUs.

Similarly, a pipeline with four-slot buffering meets its end-to-end requirements if:

- 1) $\sum_{i \in l} T_i \leq e2e_delay$, for the longest path l ,
- 2) $\max \{ 1 - \frac{T_p}{T_c} \} \leq loss_rate$, for all $T_p \leq T_c$, and
- 3) all task scheduling constraints are satisfied on their respective PCPUs.

The end-to-end delay represents the time for a message to traverse the longest path through a pipeline. The final message output from the pipeline is a transformation of data propagated through each tuned pipe.

The worst-case end-to-end delay is the sum of all the periods of the tuned pipes in the longest path, plus any blocking delays. The blocking delays are zero with asynchronous communication as each tuned pipe processes its most recent data, regardless of it being updated. Similarly, blocking delays are avoided with FIFO-based communication if each buffer is never empty or totally full.

It follows that each tuned pipe propagates a message after C_i worst-case execution time. However, if data arrives at the inputs to a tuned pipe when it has just depleted its budget, it must wait $T_i - C_i$ before the budget is replenished. If the next tuned pipe is not synchronized to start exactly when the previous pipe forwards its data there could be an additional delay of $T_i - C_i$ on top of C_i to process the data in $tpipe_i$.

To see this more clearly, consider a system of T tasks each with a service time of 1 time unit every T . Suppose two of these tasks are associated with $tpipe_1$ and $tpipe_2$. Input data D_{in} to $tpipe_1$ is processed and forwarded to $tpipe_2$, which

produces D_{out} . These two tuned pipes form a pipeline, while all other tasks compete for execution on the same PCPU. Using either rate monotonic or earliest deadline first scheduling [15] yields the same schedule in this case: neglecting scheduling overheads, each task has the same priority. A possible schedule is shown in Figure 7.

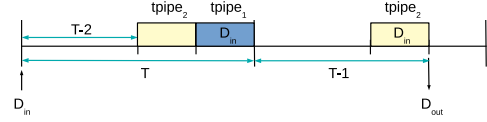

Figure 7: Worst-case delay: $D_{in} \rightarrow tpipe_1 \rightarrow tpipe_2 \rightarrow D_{out}$.

The worst-case end-to-end delay is when each of the $T - 2$ tasks other than those for $tpipe_1$ and $tpipe_2$ run immediately after the data, D_{in} , has arrived. Then, $tpipe_2$ executes and processes old input data before $tpipe_1$ is able to read D_{in} . Consequently, $tpipe_1$ does not process D_{in} and forward the output to $tpipe_2$ until T time after the data first arrived. Similarly, $tpipe_2$ is not able to run again until $2T - 2$, when it finally reads D_{in} . This is because the scheduler will not provide it with a budget replenishment until one period after it last executed. The total end-to-end delay between D_{out} and D_{in} is therefore $2T - 1$. For large T this approaches a worst-case delay of $2T$. Extending this to more than two tasks in a pipeline leads to the worst-case end-to-end delay being the sum of the corresponding tuned pipe periods.

The end-to-end throughput of a path through a FIFO buffered pipeline is limited by the minimum output rate of any one tuned pipe in that path. A tuned pipe's output rate is how many messages it is able to forward in its period. As FIFO buffering allows $tpipe_i$ to forward $m_i \geq 1$ messages per period, the minimum value of $\frac{m_i}{T_i} \geq e2e_tput$ for all i is a lower-bound on overall throughput.

For any pair of tuned pipes connected via FIFO buffers, it is essential that blocking delays are factored into the end-to-end service guarantees. Boomerang tries to avoid blocking on message exchanges by matching the arrival and departure rates of messages passed through shared FIFO buffers.

Suppose a producing and consuming pair of tuned pipes have budgets C_p and C_c , respectively. Given $C_p = C_{in}$ is sufficient to produce one message in T_p , and $C_c = C_{out}$ is sufficient to consume one message in T_c , Boomerang starts by setting $T_p = T_c = \Delta$, where $\Delta \cdot n = e2e_delay$, and n is the number of tuned pipes in the longest path. This ensures the producer and consumer are *rate-matched*, to prevent the buffer between them either completely filling or emptying.

Rate-matching is applied to all tuned pipes in the pipeline. If the pipeline cannot feasibly be scheduled on its PCPUs, each tuned pipe period is scaled by a factor α , where $\alpha > 1$. This is repeated until all tuned pipes are schedulable, but leads to a violation of the end-to-end latency requirement.

To reduce end-to-end latency, Boomerang adjusts tuned pipe periods, starting with the inputs to the pipeline. For each tuned pipe pair, T_p is repeatedly halved and C_c is similarly doubled, ensuring that $T_p > C_p$, $T_c > C_c$ and all VCPUs are

schedulable when possible. The doubling of C_c enables it to process multiple messages, m_c , in one budget cycle. T_p is reduced until either the entire pipeline meets its end-to-end delay requirement or it is set as low as feasibly possible. If $\sum_{i \in l} T_i \leq e2e_delay$ for longest path l , the algorithm stops, or else it moves onto the next stage in the path, and repeats the above procedure.

If all stages of the pipeline have been processed from input to output, the algorithm revisits each consumer whose budget is set to process multiple messages in one period. For each consumer, both C_c and T_c are halved, as long as C_c is no smaller than the time to process one message. If the path's $e2e_delay$ is satisfied, or tuned pipe periods and budgets cannot be reduced further, the algorithm stops. At this point each $C_p = m_p \cdot C_{in}$ and each $C_c = m_c \cdot C_{out}$, for $m_p, m_c \geq 1$.

If a feasible pipeline schedule is found, each FIFO buffer is set to have enough space for $m_p \cdot (\lceil \frac{T_c}{T_p} \rceil + 1)$ messages from the producer. $\lceil \frac{T_c}{T_p} \rceil$ accounts for the maximum number of times the producer can generate m_p messages within one period of the consumer. An additional m_p messages may be generated by the producer by the time the consumer accesses the buffer, due to potential phase shifting between the two tasks.

For four-slot communication, if the consumer has a smaller period than a producer at any stage in the pipeline, then the consumer will always see the most recent data. Given that four-slot communication restricts each tuned pipe to read, process and write one message every period, it is impossible for a pipeline to lose any data if all consumer periods are smaller than their corresponding producer periods. However, if a consumer has a larger period than its producer, such that $T_c > T_p$, then the producer may overwrite data before the consumer sees the previous message. It follows that the loss-rate through a four-slot pipeline is limited to the maximum value of $1 - \frac{T_p}{T_c}$ of any stage in the pipeline. This is an important metric for sensor data processing, where the fraction of lost data must be constrained.

Irrespective of four-slot or FIFO-based communication, all VCPUs serving all tuned pipes in a pipeline must satisfy the system scheduling requirements. For n tuned pipes scheduled using rate-monotonic scheduling, the scheduling constraint is satisfied if $\sum_{i=1}^n \frac{C_i}{T_i} \leq n \cdot (2^{1/n} - 1)$. If earliest-deadline first scheduling is used, the scheduling constraint is satisfied if $\sum_{i=1}^n \frac{C_i}{T_i} \leq 1$ on a single PCPU. Boomerang applies these constraints, including utilization bounds on IO VCPUs used by device pipes, to ensure pipeline schedulability. This holds for pipelines encompassing our RTOS and Linux SCHED_DEADLINE tasks.

IV. EVALUATION

We evaluated Boomerang on an Up Squared single-board computer (SBC), featuring an Intel Pentium N4200 processor, as shown in Figure 8. We connected a five-channel Kvaser USBCan Pro 5xHS CAN bus interface via USB 3.0, to emulate an automotive system.

Traffic on CAN channels 1-3 (CAN1-3) was produced by Woodward MotoHawk ECM5634-70 ECUs, as used in chassis

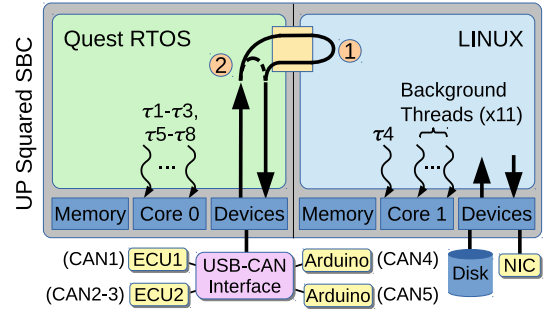

Figure 8: Boomerang experimental setup.

and powertrain applications in a real vehicle. Each of these channels produced data at 20%, 30% and 40% of their 500kpbs bandwidths, respectively. Channels 4 and 5 (CAN4-5) were replaced with Arduino UNOs [24] equipped with CAN shields, to collect performance data.

Two separate pipelines were constructed for CAN4 and CAN5, with thread budgets and periods shown in Table I. These pipelines shared three device I/O threads: `mhydra_rx` and `mhydra_tx` for Kvaser USBCan scatter-gather functionality, and a USB xHCI bottom half handler (`USB_BH`). Pipeline 1 (labeled ① in Figure 8) consisted of three task pipes: `CanRead`, `ProcData` & `CanWrite`, to read, process, and write CAN data, respectively. All tasks ran in the RTOS except `ProcData` (τ_4), which executed in Linux and represented a task requiring capabilities unavailable in the RTOS. Pipeline 1 extended from the RTOS into Linux via a secure shared memory channel using extended page table mappings. Pipeline 2 (whose I/O path is shown with a dashed line and labeled ②) consisted of two task pipes that both ran in the RTOS. These tasks were `RTFusion` and `RTControl`, for sensor data fusion and control.

Thread	Budget (ms)	Period (ms)	Utilization (%)	Core
Pipeline 1 (CAN4: $\tau_1 \rightarrow \tau_2 \rightarrow \tau_3 \rightarrow \tau_4 \rightarrow \tau_5 \rightarrow \tau_6 \rightarrow \tau_1$)				
<code>USB_BH</code> (τ_1)	0.1	1	10	0
<code>mhydra_rx</code> (τ_2)	0.2	1	20	0
<code>CanRead</code> (τ_3)	0.1	2	5	0
<code>ProcData</code> (τ_4)	0.2	2	10	1
<code>CanWrite</code> (τ_5)	0.1	2	5	0
<code>mhydra_tx</code> (τ_6)	0.2	1	20	0
<code>USB_BH</code> (τ_1)	0.1	1	10	0
Pipeline 2 (CAN5: $\tau_1 \rightarrow \tau_2 \rightarrow \tau_7 \rightarrow \tau_8 \rightarrow \tau_6 \rightarrow \tau_1$)				
<code>USB_BH</code> (τ_1)	0.1	1	10	0
<code>mhydra_rx</code> (τ_2)	0.2	1	20	0
<code>RTFusion</code> (τ_7)	0.1	2	5	0
<code>RTControl</code> (τ_8)	0.1	2	5	0
<code>mhydra_tx</code> (τ_6)	0.2	1	20	0
<code>USB_BH</code> (τ_1)	0.1	1	10	0
<code>Background</code> $\times 11$	–	–	57	1

Table I: Pipeline task parameters.

xHCI device interrupts were mapped to Core 0, while all other device interrupts were redirected to Core 1. 11 background tasks running on Core 1 generated disk and network I/O activity. These included five `wget` tasks that each retrieved a copy of a 1.9GB binary image over the Internet. Five other

tasks performed file copies of a local version of the binary image to different directories. A periodic task additionally consumed 20% of the CPU time to bring the total utilization on Core 1 (including ProcData) to 67%.

Given the above setup, we compared Boomerang to tuned pipes implemented in a standalone Linux SMP system. The standalone system did not have the support of Quest, instead mapping all tasks in Table I to the specified cores of the same OS. Yocto Linux (Pyro release), featuring kernel 4.9.99 with the PREEMPT_RT patch, was used in both the standalone system and Boomerang Linux guest. With Linux SMP, all threads were assigned budgets and periods within the SCHED_DEADLINE scheduling class except the USB_BH bottom half handler.

All experiments featuring Boomerang and Linux SMP were run for 30s, averaged over 10 runs each. End-to-end delay results are limited to the first 200 packet transmissions, due to space. In all results, similar behavior was observed for more extensive runs.

A. Asynchronous Communication

Asynchronous communication has the potential to suffer from information loss. We constructed two experiments with expected pipeline losses of 0% and 20%. In both cases, packets for Pipelines 1 and 2 arrived and departed on CAN4 and CAN5 channels, respectively. We measured the round-trip time for each packet to be read from and written to each of these channels. From Table I (Period column), the expected end-to-end delay for Pipeline 1 is 10ms, and for Pipeline 2 is 8ms.

1) *End-to-end Delay*: Figures 9a and 9b show the end-to-end delay for Pipelines 1 and 2, when there is no expected loss. The horizontal lines represent the expected latency as calculated from the sum of the task periods. The end-to-end latency for Boomerang is always less than the theoretically calculated bound. However, Linux SMP frequently fails to meet the end-to-end delay requirements. The main reason is the priority mismatch between bottom-half handlers and the task awaiting I/O operations. Our RTOS ensures that bottom-half handlers run at the correct priority with a specific CPU reservation. Therefore, Boomerang achieves temporal isolation between tasks and interrupts.

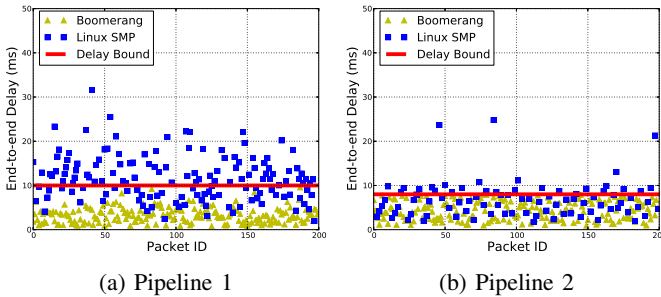

Figure 9: End-to-end delay with no expected loss.

As Linux is unable to achieve the same level of timing guarantees, even when tasks are guaranteed CPU reservations,

there are some lost packets as observed by the missing data points in Figures 9a and 9b. Table II summarizes the end-to-end latency results. It also shows that Linux suffers packet losses of 28% and 56% for Pipelines 1 and 2, respectively.

System	Min (ms)	Max (ms)	Avg (ms)	Loss (%)
Pipeline 1 (Delay bound = 10 ms)				
Boomerang	0.79	9.57	3.27	0
Linux SMP	2.1	31.5	11.70	28
Pipeline 2 (Delay bound = 8 ms)				
Boomerang	0.92	7.97	4.35	0
Linux SMP	1.8	24.77	6.79	56

Table II: Latency - no expected loss.

Boomerang experienced a total of 20623 interrupts compared to 16693 for Linux SMP during these experiments. Linux has fewer overall interrupts but more on Core 0. We conjecture this is caused by local APIC timer interrupts, which are influenced by the budget management of SCHED_DEADLINE tasks. However, this requires further investigation. Notwithstanding, Linux SMP fails to meet end-to-end delay guarantees because of its unpredictability in interrupt handling.

2) *Loss*: Sensor data processing is often tolerant of lost samples. We increased the periods of certain pipeline tasks, as shown in Table III, to allow up to 20% lost data. The expected latency for Pipeline 1 is now changed from 10ms to 11ms due to increased periods of ProcData and CanWrite. Similarly, the expected latency of Pipeline 2 is changed from 8ms to 8.5ms due to the increased periodicity of RTControl.

Task	Pipeline Loss (%)	Budget (ms)	Period (ms)
ProcData	0	0.2	2
	20	0.2	2.5
CanWrite	0	0.1	2
	20	0.1	2.5
RTControl	0	0.1	2
	20	0.1	2.5

Table III: Task parameters for different loss constraints.

Figures 10a and 10b show the the performance of Boomerang versus Linux SMP. Once again, both pipelines transfer data within their end-to-end delay bounds with Boomerang, but not with Linux SMP. The packet latency for Pipeline 2 is, on average, worse for Linux SMP in Figure 10b compared to Figure 9b. This is because the RTControl task might not receive a packet until a later period due to lost transfers. The task period itself is also larger to cause the increased likelihood of packet loss.

Boomerang keeps the loss ratio within 20%, as observed in Table IV. However, Linux SMP loses 50-55% of the 200 packets sent across each pipeline.

B. ACRN Partitioning Hypervisor

The experiments in Section IV-A were repeated with an implementation of tuned pipes in the ACRN partitioning hypervisor. ACRN has similarities to Jailhouse [11], but is already ported to the Up Squared board and is targeted at the

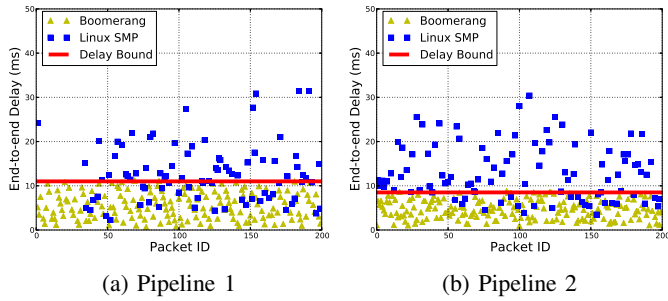

Figure 10: End-to-end delay with 20% allowed loss.

System	Min (ms)	Max (ms)	Avg (ms)	Loss (%)
Pipeline 1 (Delay bound = 11 ms)				
Boomerang	0.64	10.96	4.87	3.5
Linux SMP	2.24	98.21	14.46	55
Pipeline 2 (Delay bound = 8.5 ms)				
Boomerang	0.64	2.38	1.07	0
Linux SMP	3.49	96.02	13.91	50

Table IV: Latency - 20% allowed loss.

same applications as Boomerang. ACRN specifically supports safety-critical applications such as Automotive SDC (Software Defined Cockpit) and IVE (In-Vehicle Experience), similar to Boomerang [25]. It supports partitioning of CPU cores, memory, and I/O devices among one Service OS (SOS) and multiple User OSes (UOS). The SOS provides backend device drivers and bootstraps UOSes.

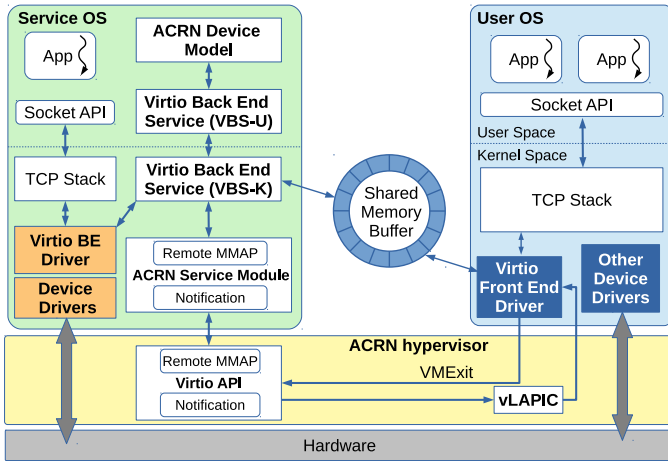

Figure 11: Inter-sandbox communication in ACRN.

The ACRN tuned pipe implementation uses a virtual network bridge and tap devices for inter-sandbox communication. Figure 11 depicts how data is exchanged between a UOS and the SOS, using shared memory ring buffers mapped to both VMs. A UOS request passes through a TCP stack and virtual device driver, causing a VMExit. Then the hypervisor notifies the SOS about the new message. Virtio services within the SOS deliver the message to the appropriate backend device driver, where it passes through the TCP stack and into user-space. Although capable of mimicking network communi-

cation between two guests, this approach incurs far more timing unpredictability compared to Boomerang’s dedicated shared memory communication channels. Data exchanges between tuned pipes in ACRN incur VMExits and, hence, control flow transitions via the ACRN hypervisor that are avoided with Boomerang. The consequence of this is shown in Figures 12a–12d, where ACRN is compared with Linux SMP. Linux SMP has already been shown to be less predictable than Boomerang in Section IV-A.

In these experiments we used a PREEMPT_RT-patched ClearOS Linux based on kernel version 4.19.73 for both the SOS and UOS, as recommended by the ACRN developers. Both ACRN and Linux SMP had the same mapping of threads to cores, as shown for Boomerang in Table I. ACRN additionally partitioned tasks and resources in the same way as Boomerang in Figure 8, except the SOS replaced Boomerang’s Quest RTOS, and the UOS featured ClearOS Linux instead of Yocto Linux. We intentionally did not port the Quest RTOS to ACRN as it would leave little difference between the solution provided by Boomerang and ACRN, except the implementation of the hypervisor and inter-sandbox communication method.

As Boomerang already outperforms Linux SMP, it follows that ACRN’s lack of timing predictability makes it inferior for end-to-end communication guarantees.

C. Synchronous Communication

We repeated experiments with Pipelines 1 and 2 using FIFO-buffering. The constraint solver described in Section III-E is used to establish correct budgets, periods and buffer sizes when pipelines are constructed. The updated budgets and periods are presented in Table V. Buffer sizes are 4, 2 and 4 messages, respectively between CanRead and ProcData, ProcData and CanWrite, and RTFusion and RTControl.

Task	Budget (ms)	Period (ms)	Utilization (%)
Pipeline 1 (CAN4)			
CanRead	0.1	2	5
ProcData	0.2	4	5
CanWrite	0.2	4	5
Pipeline 2 (CAN5)			
RTFusion	0.1	2	5
RTControl	0.125	2.5	5

Table V: Synchronous pipeline (*common threads not shown*).

1) *Throughput and Delay*: The expected end-to-end delay of Pipeline 1 is increased to 14ms because of the increased periods of the `tpipe` threads. Figures 13a and 13b show the revised end-to-end delays. Measurements are summarized in Table VI. FIFO buffering does not improve the latency for Linux SMP because of previously mentioned issues with interrupts. However, it reduces the packet loss for Linux SMP, as a buffer holds messages even if a `tpipe` thread is interrupted.

Table VII shows the throughput with Boomerang and Linux SMP are similar, although the standard deviation is smaller with Boomerang. Arrival rates (λ) from CAN4 and CAN5 are shown for each pipeline.

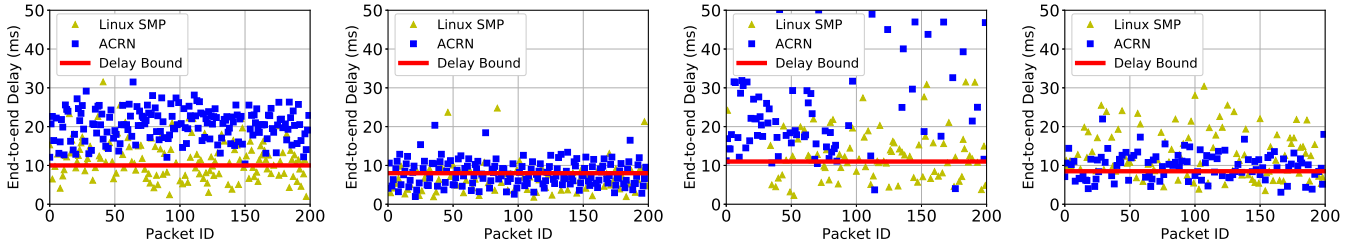

(a) Pipeline 1 - no expected loss (b) Pipeline 2 - no expected loss (c) Pipeline 1 - 20% allowed loss (d) Pipeline 2 - 20% allowed loss

Figure 12: ACRN versus Linux SMP for asynchronous communication.

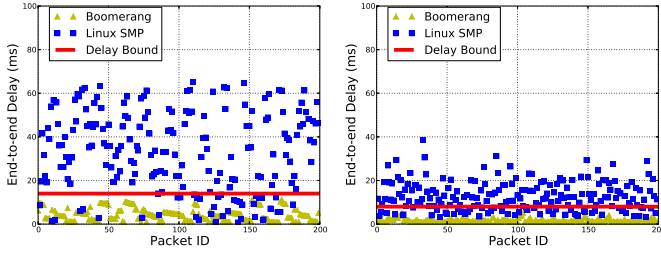

(a) Pipeline 1 (b) Pipeline 2

Figure 13: FIFO buffered synchronous communication.

System	Min (ms)	Max (ms)	Avg (ms)	Loss (%)
Pipeline 1 (Delay bound = 14 ms)				
Boomerang	0.77	11.23	4.25	0
Linux SMP	0.96	65.24	33.10	0.5
Pipeline 2 (Delay bound = 8.5 ms)				
Boomerang	0.70	5.03	1.56	0
Linux SMP	0.70	38.46	12.84	0

Table VI: Latency - FIFO buffering.

System	Min (msg/s)	Max (msg/s)	Avg (msg/s)	stddev
Pipeline 1 ($\lambda=100$ msg/s)				
Boomerang	99	101	99.77	0.63
Linux SMP	86	105	98.1	4.39
Pipeline 2 ($\lambda=125$ msg/s)				
Boomerang	123	126	124.77	0.73
Linux SMP	120	126	123.17	1.39

Table VII: Synchronous throughput.

D. MIMO Pipelines

Boomerang supports the construction of pipelines with multiple inputs and outputs (MIMO). We constructed a pipeline based on Figure 6, representative of automotive tasks where multiple sensor inputs are combined to control more than one actuator. Using the labeling in that figure, tuned pipes $A - F$ have the following (budget, period) pairs in milliseconds: A (0.1, 1), B (0.2, 2), C (0.1, 1), D (0.4, 2), E (0.1, 1) and F (0.1, 1). A reads input from CAN4 while C reads input from CAN5. Similarly, E writes back to CAN4, and F writes to CAN5. The CAN4 path traverses $ABDE$, while the CAN5 path traverses CDF . Tuned pipe D is shared by both paths; it runs in Linux while all other tuned pipes operate in the RTOS.

Tables VIIIa and VIIIb summarize the latencies and throughput, while Figure 14 shows the end-to-end delay. The

Min (ms)	Max (ms)	Avg (ms)	Std Dev	Loss (%)	Min (msg/s)	Max (msg/s)	Avg (msg/s)	Std Dev
CAN4 path (Delay bound=10 ms)					CAN4 path ($\lambda=100$ msg/s)			
0.86	9.63	2.56	1.32	0	99	101	99.74	0.58
CAN5 path (Delay bound=8 ms)					CAN5 path ($\lambda=125$ msg/s)			
0.70	5.00	2.11	0.86	0	124	126	124.74	0.58

(a) Latency

(b) Throughput

Table VIII: MIMO pipelines in Boomerang.

delay bounds of the two paths are 10ms and 8ms, accounting for 4ms worst-case delay from *mhydra rx/tx* and *USB_BH* threads, using the parameters shown in Table I. Even with multiple device inputs and outputs, both paths through CAN4 and CAN5 transfer data within their expected bounds.

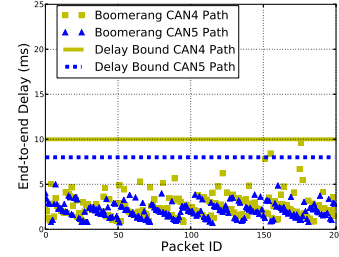

Figure 14: MIMO pipeline delay guarantees.

V. RELATED WORK

A. Operating Systems

Mercer et al implemented *processor capacity reserves* in the Mach micro-kernel [12], to provide tasks with budgets and periods. Steere et al used a reservation-based scheme along with a feedback-based controller to adjust CPU allocations among tasks [26]. Linux supports reservation-based scheduling using the `PREEMPT_RT` patch [27] and `SCHED_DEADLINE` [28] task execution managed by a Constant Bandwidth Server [23]. LITMUS^{RT} [29] is a Linux-based system that supports configurable real-time schedulers, including those with reservations. Multiple RTOSes attempt to provide temporal isolation to tasks [30]–[32]. However, these systems do not properly handle events such as interrupts, which may interfere with the timing requirements of real-time tasks.

RT-Linux virtualizes interrupts for non-time-critical parts of the system, thereby ensuring real-time service to time-critical

tasks [33]. Similar approaches have been adopted by Wind River Linux [34], the Real-time Application Interface (RTAI) for Linux [35], Xenomai [36], and NASA’s CFS Linux [37]. Zhang et al integrated interrupt handling with task scheduling in Linux. A bottom half handler for a device interrupt inherited the highest priority of a blocked process waiting on the device [9]. However, interrupt handling was not limited to a CPU reservation, meaning a burst of interrupts could still interfere with tasks.

Many real-time OSes provide a single address space, multi-threaded solution for multicore machines [38]–[40]. However, this is insufficient for many safety-critical domains, requiring both temporal and spatial isolation between components of different criticality levels. The Quest RTOS [8] not only supports multiple address spaces, but also provides a Priority-Inherited Bandwidth-preserving Server approach to serve the interrupts in a timely manner along with CPU-bound tasks. While Quest provides timing isolation for both I/O- and CPU-bound tasks, it does not support the richness of services found in a legacy system such as Linux.

B. Hypervisors

Several hypervisors attempt to support both temporal and spatial isolation of guests [41]–[44]. RT-Xen [45] adds real-time scheduling support to the Xen [46] hypervisor. However, all these hypervisors *multiplex* their guests on a shared physical machine. They virtualize interrupts, and perform additional resource management operations that conflict with the policies within each guest.

Partitioning hypervisors allow guests to directly manage subsets of machine resources. The Quest-V [10] separation kernel [47] uses a partitioning hypervisor to support the co-existence of the Quest RTOS and one or more general purpose OSes. Each guest OS runs simultaneously on separate cores in a multicore machine, with device interrupts delivered directly to the guest that owns the device.

PikeOS [48] and Muen [49] are separation kernels that support multiple guest OSes. However, unlike Quest-V, interrupts are trapped into the hypervisor, and subsequently delivered to the guest OSes. Jailhouse [11] and ACRN [50] have similarities to Quest-V. Jailhouse uses Linux to bootstrap a system that provides cells for system inmates. These are essentially restricted hardware subsets assigned to guests. ACRN’s philosophy is to allow a service OS to manage machine resources on behalf of other safety-critical OSes. However, as with Jailhouse, there is currently no way to communicate between guests with end-to-end timing guarantees. Boomerang’s partitioning hypervisor is modeled on the approach taken by Quest-V, but provides support for composable tuned pipes spanning multiple guests.

C. Predictable Communication

Boomerang’s support for composable tuned pipes is inspired by Scout [51], which treats *paths* through a sequence of services as first-class schedulable entities. Path processing is entirely within the context of a single thread that is scheduled according to the bottleneck queue. Boomerang, in contrast,

schedules each component of a pipeline with a separate time-budgeted thread. This allows paths to be interleaved and executed on different PCPUs, spanning different sandboxes.

RAD-FLOWS [52] provided a design framework for predictable data communication. Golchin et al developed a system abstraction for predictable data delivery between USB devices and a real-time process [7]. Boomerang provides support for real-time I/O to span multiple tasks in different guest VMs.

VI. CONCLUSIONS AND FUTURE WORK

This paper presents Boomerang, an I/O system comprising real-time task pipelines in a partitioning hypervisor. Boomerang’s partitioning hypervisor connects a built-in guest RTOS (Quest) with a legacy system such as Linux, via secure and predictable shared memory communication channels. The legacy OS benefits from timing predictable services that are isolated from less critical code. At the same time, the RTOS benefits from the pre-existing services, including libraries and lower criticality device drivers of a legacy non-real-time system.

Boomerang supports composable tuned pipes, for real-time task pipelines that require guaranteed end-to-end service on data transfers. The system provides real-time task pipelines with complementary legacy services that are timing predictable using CPU reservations.

Experiments show that real-time task pipelines guarantee end-to-end throughput, delay and loss requirements in Boomerang. This is the case for all pipelines contained within the RTOS and which span both the RTOS and Linux. In contrast, task pipelines in a Linux-only system are not able to ensure end-to-end service constraints, even when using CPU reservations. This is because of task interference by interrupts from I/O devices. The interrupt handlers need to be assigned suitable CPU reservations at appropriate priorities that match the pipelined tasks they serve. Alternatively, if I/O processing is assigned to a dedicated core, it reduces system utilization. Finally, other partitioning hypervisors such as ACRN rely on heavyweight networking protocols and VMExits to perform inter-guest communication via shared memory, rendering them unsuitable for real-time data processing.

Future work will extend Boomerang’s composable tuned pipes to span different physical machines. We see a programming model for real-time pipes useful in data flow machines and stream processing applications, such as those in neuromorphic computing.

ACKNOWLEDGMENT

This work is supported in part by the National Science Foundation (NSF) under Grant # 1527050. Any opinions, findings, and conclusions or recommendations expressed in this material are those of the author(s) and do not necessarily reflect the views of the NSF. Thanks also to Drako Motors for equipment used in this work. This paper has been greatly improved by the feedback of the RTAS reviewers.

Source code for this work will be made available via www.questos.org.

REFERENCES

- [1] R. O. Bernhard Leiner, Martin Schlager and B. Huber, "A Comparison of Partitioning Operating Systems for Integrated Systems," in *Proceedings of the 26th International Conference on Computer Safety, Reliability and Security (SAFECOMP)*, Nuremberg, Germany, 18-21 September 2007.
- [2] G. Niedrist, "Deterministic Architecture and Middleware for Domain Control Units and Simplified Integration Process Applied to ADAS," 2016, <https://www.tttech.com/technologies/adas>.
- [3] LynxSecure Embedded Hypervisor and Separation Kernel, 2019, <https://info.lynx.com/products/lynxsecure-programmable-processor-partitioning-system>.
- [4] AUTOSAR, 2019, AUTomotive Open System ARchitecture – <http://www.autosar.org>.
- [5] Wind River Systems, August 2008, ARINC 653 - An Avionics Standard for Safe, Partitioned Systems.
- [6] Siemens Corporate Technology, "Jailhouse Partitioning Hypervisor," October 2014, <https://github.com/siemens/jailhouse>.
- [7] A. Golchin, Z. Cheng, and R. West, "Tuned Pipes: End-to-End Throughput and Delay Guarantees for USB Devices," in *Proceedings of the 39th IEEE Real-Time Systems Symposium (RTSS)*, Dec 2018, pp. 196 – 207.
- [8] M. Danish, Y. Li, and R. West, "Virtual-CPU Scheduling in the Quest Operating System," in *2011 17th IEEE Real-Time and Embedded Technology and Applications Symposium*. IEEE, 2011, pp. 169–179.
- [9] Y. Zhang and R. West, "Process-Aware Interrupt Scheduling and Accounting," in *Proceedings of the 27th IEEE International Real-Time Systems Symposium*, ser. RTSS '06. Washington, DC, USA: IEEE Computer Society, 2006, pp. 191–201.
- [10] R. West, Y. Li, E. Missimer, and M. Danish, "A Virtualized Separation Kernel for Mixed-Criticality Systems," *ACM Transactions on Computer Systems*, vol. 34, no. 3, pp. 8:1–8:41, Jun. 2016.
- [11] R. Ramsauer, J. Kiszka, D. Lohmann, and W. Mauerer, "Look Mum, No VM Exits! (Almost)," in *Proceedings of the 13th Workshop on Operating Systems Platforms for Embedded Real-time Applications (OSPERT)*, 2017.
- [12] C. W. Mercer, S. Savage, and H. Tokuda, "Processor Capacity Reserves for Multimedia Operating Systems," in *Proceedings of the IEEE International Conference on Multimedia Computing and Systems*, 1994.
- [13] J. Lehoczy, L. Sha, and Y. Ding, "The Rate Monotonic Scheduling Algorithm: Exact Characterization and Average Case Behavior," in *Proceedings of the IEEE Real-Time Systems Symposium (RTSS)*, 1989.
- [14] B. Sprunt, "Scheduling Sporadic and Aperiodic Events in a Hard Real-Time System," Software Engineering Institute, Carnegie Mellon, Tech. Rep., 1989.
- [15] C. L. Liu and J. W. Layland, "Scheduling Algorithms for Multiprogramming in a Hard Real-Time Environment," *Journal of the ACM*, vol. 20, no. 1, pp. 46–61, 1973.
- [16] H. Simpson, "Four-slot Fully Asynchronous Communication Mechanism," *IEEE Computers and Digital Techniques*, vol. 137, pp. 17–30, January 1990.
- [17] A. Hamann, D. Dasari, S. Kramer, M. Pressler, and F. Wurst, "Communication Centric Design in Complex Automotive Embedded Systems," in *Proceedings of the 29th Euromicro Conference on Real-Time Systems*, Dagstuhl, Germany, 2017.
- [18] ISO, "ISO 26262-3: Road vehicles - Functional safety - Part 3: Concept phase," 2011.
- [19] N. Zeldovich, S. Boyd-Wickizer, E. Kohler, and D. Mazieres, "Making information flow explicit in histar," in *OSDI '06: Proceedings of the second USENIX symposium on Operating systems design and implementation*, 2006, pp. 263–278.
- [20] P. Efstathopoulos, M. Krohn, S. VanDeBogart, C. Frey, D. Ziegler, E. Kohler, D. Mazières, F. Kaashoek, and R. Morris, "Labels and Event Processes in the Asbestos Operating System," in *SOSP '05: Proceedings of the twentieth ACM symposium on Operating systems principles*. New York, NY, USA: ACM Press, 2005, pp. 17–30.
- [21] D. E. Bell and L. J. LaPadula, "Secure Computer System: Unified Exposition and Multics Interpretation," Mitre Corporation, Bedford, MA, Tech. Rep. ESD-TR-75-306, March 1976.
- [22] J. Rushby, "Model Checking Simpson's Four-slot Fully Asynchronous Communication Mechanism," *Computer Science Laboratory—SRI International, Tech. Rep. Issued*, 2002.
- [23] L. Abeni and G. Buttazzo, "Integrating Multimedia Applications in Hard Real-Time Systems," in *Proceedings of the 19th IEEE Real-time Systems Symposium*, 1998, pp. 4–13.
- [24] Arduino Homepage, 2019, <http://arduino.cc>.
- [25] S. Sinha, A. Golchin, C. Einstein, and R. West, "A Paravirtualized Android for Next Generation Interactive Automotive Systems," in *Proceedings of the 21st International Workshop on Mobile Computing Systems and Applications (HotMobile 2020)*, Austin, Texas, USA, March 3–4 2020.
- [26] D. C. Steere, A. Goel, J. Gruenberg, D. McNamee, C. Pu, and J. Walpole, "A Feedback-driven Proportion Allocator for Real-rate Scheduling," in *Proceedings of the Third Symposium on Operating Systems Design and Implementation*, ser. OSDI '99. USENIX Association, 1999, pp. 145–158, new Orleans, Louisiana, USA.
- [27] PREEMPT_RT, 2019, https://rt.wiki.kernel.org/index.php/Main_Page.
- [28] Linux, "SCHED_DEADLINE Policy," 2019, <https://www.kernel.org/doc/Documentation/scheduler/sched-deadline.txt>.
- [29] J. M. Calandrino, H. Leontyev, A. Block, U. C. Devi, and J. H. Anderson, "*Litmus^{RT}*: A Testbed for Empirically Comparing Real-time Multiprocessor Schedulers," in *2006 27th IEEE International Real-Time Systems Symposium (RTSS'06)*. IEEE, 2006, pp. 111–126.
- [30] VxWorks, 2019, <https://www.windriver.com/products/vxworks/>.
- [31] D. Bayer and H. Lycklama, "MERT-A Multi-environment Real-time Operating System," in *ACM SIGOPS Operating Systems Review*, vol. 9, no. 5. ACM, 1975, pp. 33–42.
- [32] J. J. Labrosse, *MicroC/OS-II: The Real Time Kernel*. CRC Press, 2002.
- [33] V. Yodaiken, *The RT Linux Manifesto*, 1999.
- [34] Wind River Systems, 2019, <https://www.windriver.com/products/linux/>.
- [35] L. Dozio and P. Mantegazza, "Linux Real Time Application Interface (RTAI) in Low Cost High Performance Motion Control," *Motion Control*, vol. 2003, no. 1, pp. 1–15, 2003.
- [36] Xenomai, Last Released: 2018, <https://xenomai.org/>.
- [37] NASA, "cfsLinux," 2019, <https://cfs.gsfc.nasa.gov/>.
- [38] eCos, "Embedded Configurable Operating System," <http://ecos.sourceforge.org/>, 2019.
- [39] OAR Corporation, "RTEMS," Last Release: 2016, <https://www.rtems.org/>.
- [40] Real Time Engineers Ltd., "FreeRTOS," 2019, <https://www.freertos.org/>.
- [41] W. R. Systems, "Wind River Hypervisor," 2019, <https://www.windriver.com/products/operating-systems/virtualization/>.
- [42] Mentor, "Mentor Embedded Hypervisor," 2019, <https://www.mentor.com/embedded-software/hypervisor/>.
- [43] Tenasys, "eVM for Windows," 2019, <https://www.tenasys.com/products/evm-for-windows/>.
- [44] M. Masmano, I. Ripoll, A. Crespo, and J. Metge, "Xtratium: a Hypervisor for Safety Critical Embedded Systems," in *11th Real-Time Linux Workshop*. Citeseer, 2009, pp. 263–272.
- [45] S. Xi, J. Wilson, C. Lu, and C. Gill, "RT-Xen: Towards Real-time Hypervisor Scheduling in Xen," in *Proceedings of the ninth ACM international conference on Embedded software*. ACM, 2011, pp. 39–48.
- [46] P. Barham, B. Dragovic, K. Fraser, S. Hand, T. Harris, A. Ho, R. Neugebauer, I. Pratt, and A. Warfield, "Xen and the Art of Virtualization," in *ACM SIGOPS operating systems review*, vol. 37, no. 5. ACM, 2003, pp. 164–177.
- [47] J. Rushby, "The Design and Verification of Secure Systems," in *Eighth ACM Symposium on Operating System Principles (SOSP)*, Asilomar, CA, Dec. 1981, pp. 12–21, (ACM Operating Systems Review, Vol. 15, No. 5).
- [48] SYSGO, "PikeOS," Last release: Version 4.2, April 2017, <http://www.sysgo.com/products/pikeos-rtos-and-virtualization-concept>.
- [49] R. Buerki and A.-K. Rueeggsegger, "Muen - An x86/64 Separation Kernel for High Assurance," *University of Applied Sciences Rapperswil (HSR), Tech. Rep.*, 2013.
- [50] Project ACRN, 2019, <https://projectacrn.org/>.
- [51] D. Mosberger and L. L. Peterson, "Making Paths Explicit in the Scout Operating System," in *Proceedings of the Second USENIX Symposium on Operating Systems Design and Implementation*, ser. OSDI '96. New York, NY, USA: ACM, 1996, pp. 153–167.
- [52] R. Pineiro, K. Ioannidou, S. A. Brandt, and C. Maltzahn, "RAD-FLOWS: Buffering For Predictable Communication," in *Proceedings of the 17th IEEE Real-Time and Embedded Technology and Applications Symposium*, April 2011, pp. 23–33.